



skb.se

**SKB P-22-24**

ISSN 1651-4416

ID 1997157

May 2023

## **Prototype Repository – Sensor data report**

**Period 2001-09-17 to 2022-01-01**

**Report No 33**

Reza Goudarzi  
Clay Technology AB

This report concerns a study which was conducted for Svensk Kärnbränslehantering AB (SKB). The conclusions and viewpoints presented in the report are those of the author. SKB may draw modified conclusions, based on additional literature sources and/or expert opinions.

Data in SKB's database can be changed for different reasons. Minor changes in SKB's database will not necessarily result in a revised report. Data revisions may also be presented as supplements, available at [www.skb.se](http://www.skb.se).

This report is published on [www.skb.se](http://www.skb.se)

© 2023 Svensk Kärnbränslehantering AB

# Summary

The Prototype Repository Test consists of two sections. The installation of the first Section of Prototype Repository was made during summer and autumn 2001 and Section 2 was installed in spring and summer 2003. The retrieval of the outer section started at the end of November 2010 and finished at the end of December 2011. All measurements from the sensor in section 2 have been presented in the sensors data report SKB P-13-39 (Goudarzi 2014).

After the retrieval of the outer section, validation tests of the total pressure sensors of type Geocon were made. It was then discovered that, the up to 2012-01-01 used calibration values (linear equation) gave inaccurate readings of the total pressure. The improvements of the readings were large when a polynomial calibration equation was used instead. At the presentation of the data in this report the polynomial equation was used.

This report presents data from measurements in the Prototype Repository section 1 during the period 2001-09-17–2022-01-01. The actual measured results are shown in Appendix 1-5, where Appendix 5 deals with measurement of water pressure in the rock (by Sweco Environment). The main report and Appendix 1-4 deal with the rest of the measurements.

## Section 1

The following measurements are made in the bentonite in each of the two instrumented deposition holes in Section 1 (1 and 3): Temperature is measured in 32 points, total pressure in 27 points, pore pressure in 14 points and relative humidity in 37 points. Temperature is also measured by all relative humidity sensors. Every measuring point is related to a local coordinate system in the deposition hole.

The following measurements are made in the backfill in Section 1. Temperature is measured in 20 points, total pressure in 18 points, pore water pressure in 23 points and relative humidity in 45 points. Temperature is also measured by all relative humidity sensors. Furthermore, water content is measured by an electric chain in one section. Every measuring point is related to a local coordinate system in the tunnel.

The following measurements are made on the surface of the canisters in Section 1: Temperature is measured every meter along two fibre optic cables from BICC Thermoheat. More detail described in report KB 1PR-02-03 (Collin and Börgesson 2001).

Furthermore, displacements of the canister in hole 3 are measured with 6 displacement sensors.

The following measurements are made in the rock in Section 1: Temperature is measured in 37 points in boreholes in the floor. Water pressure is measured in altogether 64 points in 17 boreholes all around the tunnel.

## Conclusions

A general conclusion is that the measuring systems work well during this measuring period (2020-01-01–2022-01-01). 299 (excluding water pressure sensors in the rock) out of totally 363 installed sensors in Section 1 are out of order, the majority (51 of 74) relative humidity (RH) sensors fail at water saturation. Furthermore, all suction sensors (45 of 45) placed in the backfill is not giving reliable values due to high degree of saturation (RH 100 %).

In December 2019 (day 6665) the power in canister No 1 has switched off due all electrical heaters are out of order like as the power in canister No 2 and No 3. The power to canister No 4 was about 300 W (planned 1200 W) in the end of this measuring period.

The drainages of the inner section together with the drainage of the outer plug were closed at the beginning of November 2004. The pressure (pore pressure and total pressure) both in the backfill and in some parts of the buffer in the 4 deposition holes increased after this date. At the beginning of December 2004 damages on the cables to the installed heaters in one of the canisters (canister No 2) was observed. The power to all the canisters was then switched off and the drainage of the tunnel was

opened. The power of canisters was switched on again on December 15 except for canister No 2 where all the installed heaters were out of order. The drainage of the tunnel was kept open. The increase in pore pressure affected the saturation rate of the backfill and the buffer. The failure of the heaters in canister No 2 and the time when the power was switched off also affected the measurements especially the temperature measurements in the buffer. A packer installed in the rock in Section 1 was broken around the 18<sup>th</sup> of April 2006. The broken packer caused an increase in the measured total and pore pressure in the backfill in Section 1. The work with the new tunnel near by the Prototype site which started in April 2007 has affected the pressure, water outflow and saturation of the backfill. Some packers installed in the rock in Section 2 have been reinstalled because of leakage at 16<sup>th</sup> of December 2014.

This activity is probably caused increasing of total and pore pressure, in the backfill and the buffer (block C4) in deposition hole1 and hole3 at the end of 2014.

# Sammanfattning

Prototypförvaret består av två sektioner. Den första sektionen installerades under sommaren och hösten 2001 och Sektion 2 installerades under våren och sommaren 2003. I slutet av november 2010 började arbetet med att demontera den yttre sektionen av försöket och avslutades i december 2011. Alla mätdata från givare i yttre sektionen har presenterats i ”Sensors data report SKB P-13-19” (Goudarzi 2014).

Efter demontering av yttre sektionen, utfördes en utvärdering av totaltrycksgivarna av fabriket Geocon. Då upptäcktes att de använda kalibreringsparametrarna och den linjära ekvationen för totaltryck inte var optimala. Den alternativa polynoma ekvationen vid redovisning av data används i den här rapporten vilket gav högre tryck.

I denna rapport presenteras data från mätningar i Prototypförvaret för sektion I under perioden 2001-09-17–2022-01-01. Rapporten är uppdelad så att själva mätresultaten redovisas i Appendix 1–5, Appendix 5 behandlar vattentrycksmätningar i berget (handhas av Sweco Environment).

I själva huvudrapporten och Appendix 1–4 behandlas alla övriga mätningar.

## Sektion 1

Följande mätningar görs i bentoniten i vardera av de två instrumenterade deponeringshålen i Sektion 1 (1 och 3): Temperatur mäts i 32 punkter, totaltryck i 27 punkter, porvattentryck i 14 punkter och relativa fuktigheten i 37 punkter. Temperaturen mäts även med relativa fuktighet mätare. Varje mätpunkt relateras till ett lokalt koordinatsystem i deponeringshålet.

Följande mätningar görs i återfyllningen i Sektion 1: Temperaturen mäts i 20 punkter, totaltryck i 18 punkter, porvattentryck i 23 punkter och relativa fuktigheten i 45 punkter. Temperaturen mäts även med alla relativa fuktighetsmätare. Dessutom mäts vatteninnehållet i en sektion med en geoelektrisk mätkedja. Varje mätpunkt relateras till ett lokalt koordinatsystem i tunneln.

Följande mätningar görs på ytan i kapselns kopparhölje i samtliga 4 kapslar i Sektion 1: Temperaturen mäts varje meter längs två fiberoptiska kablar från två håll. Dessutom mäts förskjutningar av kapseln i hål 3 med 6 givare.

Följande mätningar görs i berget i Sektion 1: Temperatur mäts i borrhål i 37 punkter i golvet. Vattentryck mäts i sammanlagt 64 punkter i 17 borrhål runt hela tunneln.

## Slutsatser

En allmän slutsats är att mätsystemen fungerar bra under denna mätperiod (2021-01-01–2022-01-01). 299 (exklusive vattentryckssensorer i berget) av totalt 363 installerade sensorer i sektion 1 är ur funktion, varav flesta av RH-givare (51 av 74) som slutade fungera vid vattenmättnad. Dessutom ger nästan alla (44 av 45) psychrometer som placerade i återfyllningen inte tillförlitliga värden på grund av hög mättnadsgrad (RH 100 %).

I december 2019 (dag 6665) har effekten i Kapsel-1 stängts av eftersom alla elektriska värmare har slutat fungera. Effekten i kapslarna 2 och 3 har varit avstängda p.g.a. alla elektriska värmare i de här kapslarna är ur funktion.

I slutet av den här mätperioden effekten i kopparkapsel 4 var ca 300 W (planerad 1200 W).

Portrycket och totaltrycket både i återfyllnaden och i alla sex deponeringshålerna ökade markant efter stängningen av dränaget i båda sektionen i början av november 2004. Ökningen av portrycket påverkade också vattenmättnaden i vissa delar av buffert i alla 6 deponeringshål och återfyllnaden. Skador observerades på kablarna till de installerade värmarna i två av kapslarna i början av december 2004, varefter effekten till samtliga kapslar stängdes av samtidigt som dräneringen av tunneln öppnades. Effekten till alla kapslar utom kapsel nr. 2 sattes på igen den 15:e december. Skadorna på kablarna till värmarna i kapsel 2 var så omfattande att det inte var möjligt att använda dessa. Dräneringen av tunneln förblev öppen. En packer installerad i berget i Sektion 1 gick sönder kring den 18:e april 2006. Den läckande packern medförde att totaltrycken och portrycken i återfyllningen i Sektion 1 ökade markant. Arbetet med den nya tunneln nära Prototype-tunneln vilket startade i april



2007 har påverkat tryckte, utflödet ur tunneln samt vattenmättnaden av återfyllningen i de båda tunnelsektionerna. Ett antal läckande manschetter i yttre sektionen byttes ut den 16:e december 2014 (dag 4836). Den stora ökningen i både totaltryck och poretryck som uppmättes både i återfyllningen och i block C4 i de två deponeringshål 1 och 3 orsakades förmodligen av denna aktivitet.

# Table of Contents

<b>1</b>	<b>Introduction</b> .....	<b>8</b>
<b>2</b>	<b>Geometry and coordinate systems</b> .....	<b>9</b>
<b>3</b>	<b>Brief description of the instruments</b> .....	<b>11</b>
<b>4</b>	<b>Location of instruments in Section 1</b> .....	<b>12</b>
4.1	Strategy for describing the position of each device in the bentonite and rock in and around the deposition holes .....	12
4.2	Position of each instrument in the bentonite in hole 1 (DA3587G01) .....	14
4.3	Position of each instrument in the bentonite in hole 3 (DA3575G01) .....	18
4.4	Instruments on the canister surface in holes 1-4 .....	22
4.5	Position of temperature sensors in the rock .....	24
4.6	Strategy for describing the position of each device in the backfill in section 1 .....	26
4.7	Position of each instrument in the backfill .....	28
<b>5</b>	<b>Results and comments for Section 1</b> .....	<b>32</b>
5.1	General .....	32
5.2	Deposition hole 1 .....	36
5.2.1	Total pressure .....	36
5.2.2	Relative humidity .....	36
5.2.3	Pore water pressure .....	36
5.2.4	Temperature in the buffer (Appendix 1\pages 50-53) .....	36
5.2.5	Canister power in dep. hole 1 (Appendix 1\page 55) .....	37
5.2.6	Temperature on the canister surface (Appendix 1\page 56) .....	37
5.3	Deposition hole 3 .....	37
5.3.1	Total pressure .....	37
5.3.2	Relative humidity .....	37
5.3.3	Pore water pressure .....	38
5.3.4	Temperature in the buffer (Appendix 2\pages 65-68) .....	38
5.3.5	Canister power in dep. hole 3 (Appendix 2\page 69) .....	38
5.3.6	Temperature on the canister surface (Appendix 2\pages 70-71) .....	38
5.4	Deposition hole 2 .....	39
5.4.1	Canister power (Appendix 3\page 72) .....	39
5.4.2	Temperature on the canister surface (Appendix 3\pages 73-74) .....	39
5.5	Deposition hole 4 .....	39
5.5.1	Canister power (Appendix 3\page 75) .....	39
5.5.2	Temperature on the canister surface (Appendix 3\pages 75-76) .....	39
5.6	Backfill in Section 1 .....	39
5.6.1	Total pressure in the backfill .....	39
5.6.2	Suction in the backfill (Appendix 4\pages 79-82) .....	40
5.6.3	Pore water pressure in the backfill .....	40
5.6.4	Temperature in the backfill (Appendix 4\pages 84-86) .....	40
5.7	Temperature in the rock .....	40
5.7.1	Near hole 1 (Appendix 1\pages 54-55) .....	40
5.7.2	Near hole 2 (Appendix 3\page 72) .....	41
5.7.3	Near hole 3 (Appendix 2\pages 68-69) .....	41
5.7.4	Near hole 4 (Appendix 3\page 74) .....	41
	<b>References</b> .....	<b>42</b>
	<b>Appendix 1</b> .....	<b>43</b>
	Dep. hole 1 .....	43
	<b>Appendix 2</b> .....	<b>57</b>
	Dep. hole 3 .....	57

<b>Appendix 3 .....</b>	<b>72</b>
Dep. holes 2 and 4 .....	72
<b>Appendix 4 .....</b>	<b>77</b>
Backfill in section 1.....	77
<b>Appendix 5 .....</b>	<b>87</b>
A5.1 Water pressure measurements in the rock mass .....	87
A5.1.1 Introduction .....	87
A5.1.2 Measurements in the boreholes .....	87
A5.1.3 Instrumentation with bentonite packers in Section I .....	87
A5.1.4 Instrumentation with mechanical packers .....	92
A5.1.5 Calibration intervals .....	92
A5.1.6 Pressure measurements.....	92
A5.1.7 Drainage of Section I.....	100
A5.1.8 Flow measurements .....	101
A5.1.9 Water sampling.....	103

# Quick guide

## Sensors in the backfill

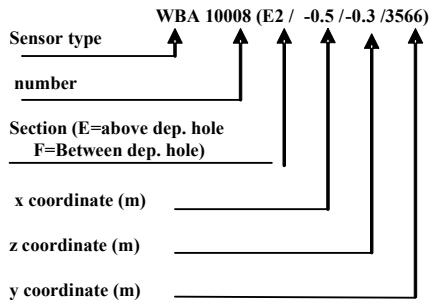

## Sensors in dep. holes 1,3,5 and 6 and in the rock

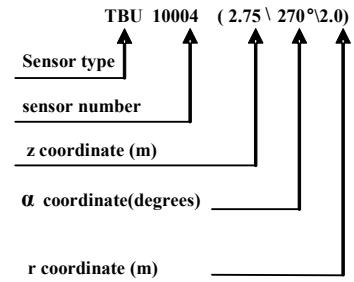

## Coordinate system in backfill

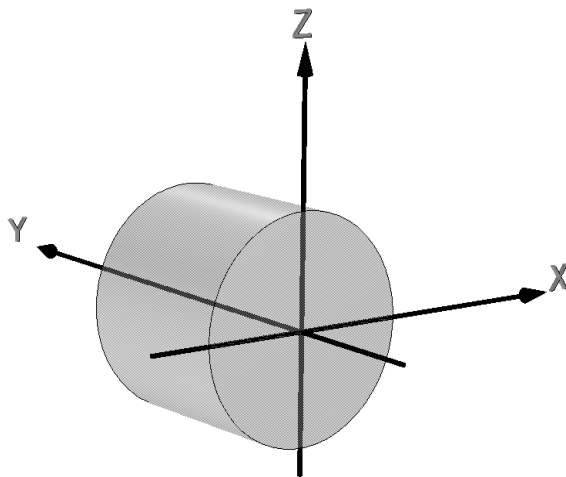

## Coordinate system in dep. holes

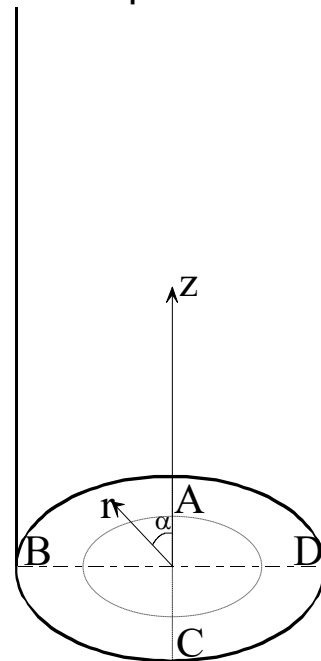

*A headed against the end of the tunnel*

End of tunnel at	Y = 3599.8 m
Center dep. hole1 at	Y = 3587.0 m
Center dep. hole2 at	Y = 3581.0 m
Center dep. hole3 at	Y = 3575.0 m
Center dep. hole4 at	Y = 3569.0 m
Inner plug surface at	Y = 3561.4 m
Center dep. hole5 at	Y = 3551.0 m
Center dep. hole6 at	Y = 3545.0 m
Outer plug surface at	Y = 3538.6 m
Tunnel radius	Z=X = 2.5 m

Tunnel direction	C - A
Bottom of hole	Z = 0.000 m
Bottom of canister	Z = 0.500 m
Top of canister	Z = 5.400 m
Upper buffer surface	Z = 7.125 m
Dep. hole radius	r = 0.875 m
Canister radius	r = 0.525 m

# 1 Introduction

The Prototype Repository consist of, after the dismantling of the outer section, one tunnel section (Section 1) and four deposition holes, see Figure 1-1. The installation of the first Section of Prototype Repository was made during summer and autumn 2001 and Section 2 was installed in spring and summer 2003.

Section 1 consists of four full-scale deposition holes, copper canisters equipped with electrical heaters, bentonite blocks and a deposition tunnel backfilled with a mixture of bentonite and crushed rock and ends with a concrete plug as shown in Figure 1-1. Section 2 consists of two full-scale deposition holes with a backfilled tunnel section and ends also with a concrete plug. Section 2 was excavated during 2010.

The bentonite buffer in deposition holes 1 and the backfill and the surrounding rock are instrumented with sensors for measuring temperature, water pressure, total pressure, relative humidity, resistivity and canister displacement. The instruments are connected to data collection systems by cables protected by tubes, which are led through the rock in watertight lead throughs.

The water inflow into the deposition holes before installation is presented in SKB IPR-00-30 (Svemar and Pusch 2000). The inflow measured to be below 0.1 L/min in all deposition holes. The maximum inflow was into hole 1 (0.08 L/min) and minimum inflow into hole 4 (0.0007 L/min).

The estimation of inflow (L/min) into all deposition holes before installation was: hole 1 = 0.08, hole 2 = 0.002, hole 3 = 0.003, hole 4 = 0.0007, hole 5 = 0.002, hole 6 = 0.003.

Earlier estimation and measurement of in-leaking ground water amounts to the backfill tunnel is presented in SKB IPR-01-31 (Forsmark et al. 2001) and in SKB IPR-01-65 (Rhén and Forsmark 2001).

In general, the data for Section 1 in this report are presented in diagrams covering the time period 2001-09-17 to 2022-01-01. With “this measuring period” in this report means the time period 2021-01-01 to 2022-01-01.

The time axis in the diagrams represent number of days from start 2001-09-17, which is the day the heating of the canister in hole 1 was started. For Section 2 the data had presented in diagrams covering the time period 2003-05-08 to 2011-01-01 in the sensors data report No 25 (Goudarzi 2014).

This report consists of several parts. In chapters 2, 3 and 4 a test overview with the positions of those measuring points and a brief description of the instruments are shown. In chapter 5 the measured results from all measurements in Section 1, except water pressure in the rock, are presented and commented. The diagrams of those measured results are attached in Appendix 1-4. The result and comment of the measurements of water pressure in the rock is presented separately in Appendix 5.

A quick guide to the position of the instruments in the buffer and backfill is shown on page 7.

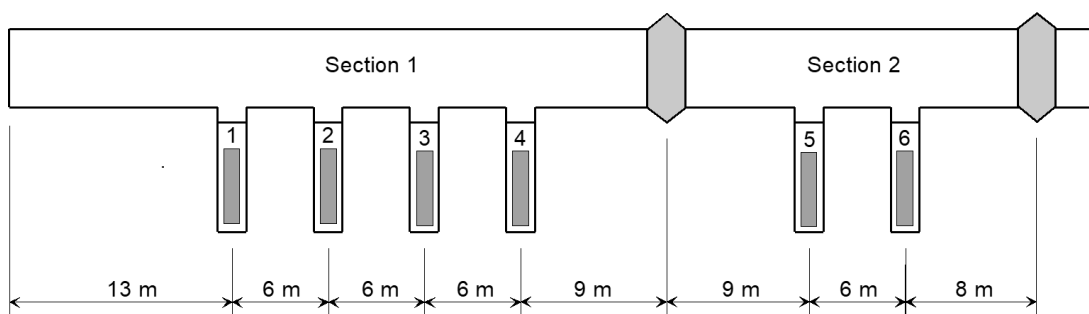

*Figure 1-1 Schematic view of the Prototype Repository.*

## 2 Geometry and coordinate systems

The Prototype Repository consists of two sections as shown in Figure 1-1. The geometry and the coordinate system for the sensors are different for the deposition holes and the tunnel. The temperature sensors in the rock are defined with the same coordinate system as the deposition holes.

### Deposition holes

In Section 1 the deposition holes are termed 1-4 according to Figure 1-1. The coordinate system for these holes is shown in Figure 2-1. With the  $z$ -axis starting from the cement casting and the angle  $\alpha$  counted anti-clockwise from direction A. Measurements are mainly made in four vertical sections A, B, C and D according to Figure 2-1. Direction A and C are placed in the tunnels axial direction with A headed against the end of the tunnel i.e. almost towards West.

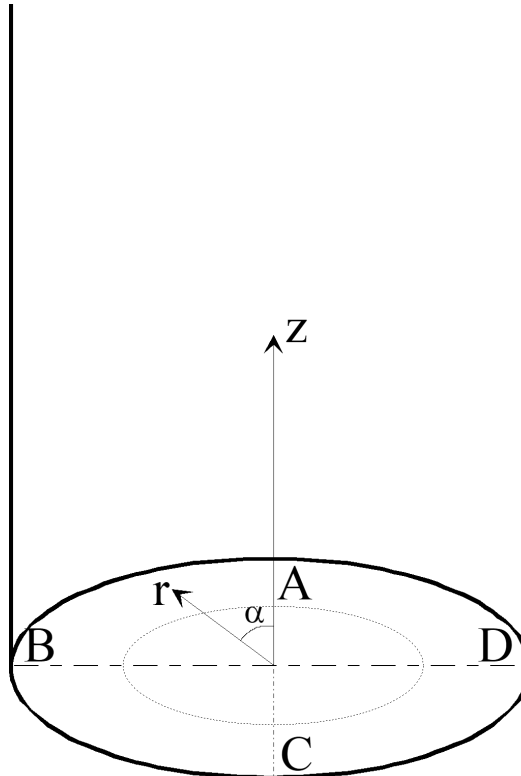

*Figure 2-1 Figure describing the instrument planes (A-D) and the coordinate system used when describing the instrument positions(A headed against the end of the tunnel).*

## Tunnel

The coordinate system of the backfill in the tunnel is shown in Figure 2-2. The coordinate  $y$  starts at the entrance on ground, which means that the tunnel ends at  $y = 3599, 8$ . The  $y$ -axis runs in the centre of the tunnel, which means that the tunnel walls intersect the  $z$  and  $x$ -axes at  $\pm 2.5$  m. The  $z$ -coordinate is determined positive upwards and the  $x$ -coordinate is determined positive to the right when facing the end of the tunnel.

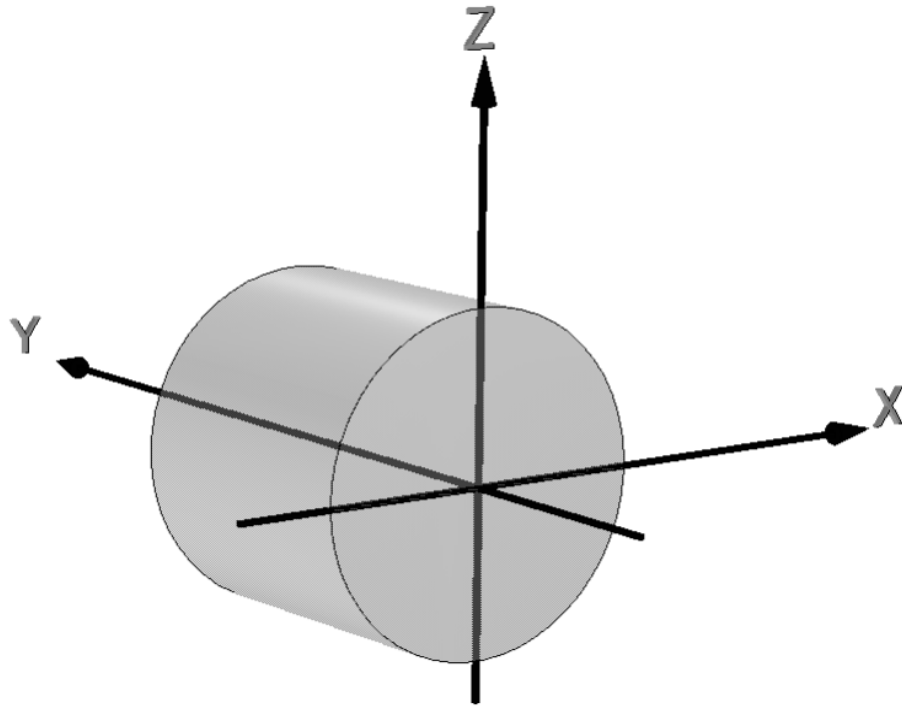

*Figure 2-2 Coordinate system of the tunnel.*

### 3 Brief description of the instruments

The different standard instruments that are used in the buffer, backfill and rock (temperature) are briefly described in this chapter.

#### Measurements of temperature

##### *Buffer, backfill and rock*

Thermocouples from Pentronic have been used to measure temperature. Measurements are done in 32 points in each instrumented hole (hole1 and hole 3). In addition, temperature measured also by the capacitive relative humidity sensors and some of the other sensor types as well.

##### *Canister*

Temperature is measured on the surface of the canister with optical fibre cables. An optical measuring system called FTR (Fibre Temperature Laser Radar) from BICC Thermal is used. SKB 1PR-02-03 (Collin and Börgesson 2001).

#### Measurement of total pressure in the buffer and backfill

Total pressure is the sum of the swelling pressure and the pore water pressure. It is measured with the following instrument types:

- Geocon total pressure cells with vibrating wire transducers.
- Kulite total pressure cells with piezo resistive transducers.

#### Measurement of pore water pressure in the buffer and backfill

Pore water pressure is measured with the following instrument types:

- Geocon pore pressure cells with vibrating wire transducer.
- Kulite pore pressure cells with piezo resistive transducer.

#### Measurement of the water saturation process in the buffer and backfill

The water saturation process is recorded by measuring the relative humidity in the pore system, which can be converted to total suction (negative water pressure). The following techniques and devices are used:

- Vaisala relative humidity sensor of capacitive type. The measuring range is 0-100 % RH.
- Rotronic relative humidity sensors of capacitive type. The measuring range is 0-100 % RH.
- Wescor soil psychrometer. The sensor is measuring the dry and the wet temperature in the pore volume of the material. The measuring range is 95.5-99.6 % RH corresponding to the pore water pressure  $-0.5$  to  $-6$  MPa. Psychrometers are placed in the backfill in section 1.



## **4 Location of instruments in Section 1**

### **4.1 Strategy for describing the position of each device in the bentonite and rock in and around the deposition holes**

The same principles are used for describing the position of all sensors in the bentonite inside the deposition holes as well as the thermocouples in the rock around the deposition holes. The principles are described in the quick guide on page 9.

The type of instruments and their locations are described in detail in Börgesson and Sandén (2001). Every instrument is named with a unique name consisting of 1 letter describing the type of measurement, 2 letters describing where the measurement takes place (buffer, backfill, rock or canister), 1 digit denoting the deposition hole (1-4) and 4 specifying the instrument according to a separate list (see Table 4-1 to 4-9). Every instrument position is then described with three coordinates according to Figure 2-1.

The  $r$ -coordinate is the horizontal distance from the centre of the hole and the  $z$ -coordinate is the height from the surface of the bottom casting of the hole (the block height is set to 500mm). The  $\alpha$ -coordinate is the angle from the vertical direction A (almost West).

Figure 4-1 shows an overview of the instruments in the buffer. The bentonite blocks are called cylinders and rings. The cylinders are numbered C1-C4 and the rings R1-R10 respectively.

- pore water pressure + temp.
- total pressure + temp.
- × temp.
- △ relative humidity (+ temp.)

1m

A

B+C

D

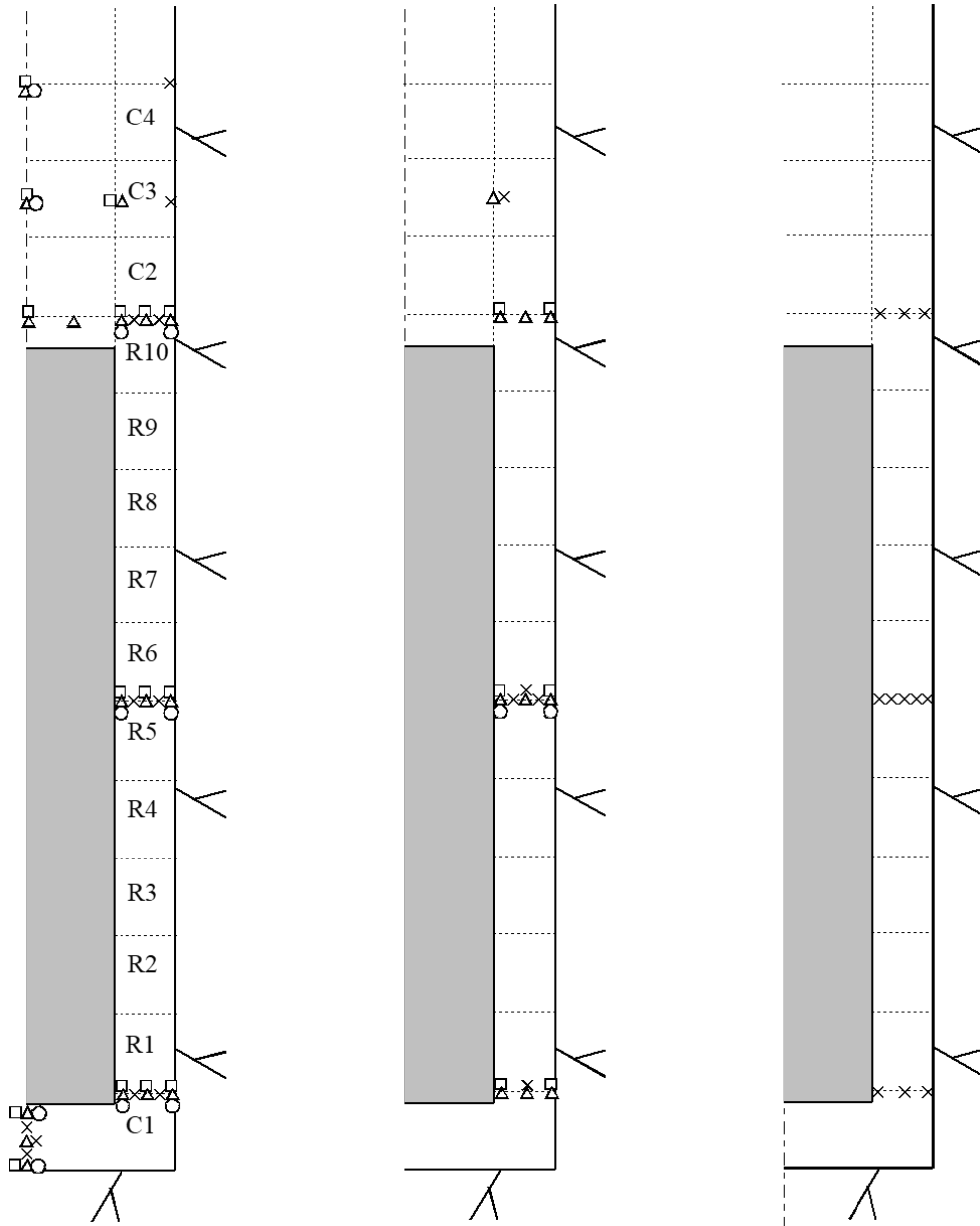

Figure 4-1 Schematic view over the instruments in four vertical sections and the block designation.

## 4.2 Position of each instrument in the bentonite in hole 1 (DA3587G01)

The instruments are located in three main levels in the blocks, 50 mm, 160 mm and 250 mm, from the upper surface. The thermocouples are mostly placed in the 50 mm level and the other sensors in the 160 mm level except for the Geocon type 1 pressure sensors and the Rotronic humidity sensors, which are placed in the 250 mm level depending on the size of the sensor house.

Exact positions of the sensors are described in Tables 4-1 to 4-4.

**Table 4-1** Numbering and position of thermocouple sensors for measuring temperature (T) in the buffer in hole 1.

Type and number	Block	Instrument position				Fabricator	Remark
		Direction	$\alpha$ degree	r m	z m		
TBU10001	Cyl. 1	Center	270	0,050	0,054	Pentronic	
TBU10002	Cyl. 1	Center	270	0,050	0,254	Pentronic	
TBU10003	Cyl. 1	Center	270	0,050	0,454	Pentronic	
TBU10004	Cyl. 1	A	355	0,635	0,454	Pentronic	
TBU10005	Cyl. 1	A	355	0,735	0,454	Pentronic	
TBU10006	On top of the canister in hole 2					Pentronic	
TBU10007	Cyl. 1	C	175	0,685	0,454	Pentronic	
TBU10008	Cyl. 1	D	270	0,585	0,454	Pentronic	
TBU10009	Cyl. 1	D	270	0,685	0,454	Pentronic	
TBU10010	Cyl. 1	D	270	0,785	0,454	Pentronic	
TBU10011	Ring 5	A	0	0,635	2,980	Pentronic	
TBU10012	Ring 5	A	0	0,735	2,980	Pentronic	
TBU10013	Ring 5	B	90	0,585	2,980	Pentronic	
TBU10014	Ring 5	B	90	0,685	2,980	Pentronic	
TBU10015	Ring 5	B	90	0,785	2,980	Pentronic	
TBU10016	Ring 5	C	175	0,585	2,980	Pentronic	
TBU10017	Ring 5	C	175	0,685	2,980	Pentronic	
TBU10018	Ring 5	C	175	0,735	2,980	Pentronic	
TBU10019	Ring 5	D	270	0,585	2,980	Pentronic	
TBU10020	Ring 5	D	270	0,635	2,980	Pentronic	
TBU10021	Ring 5	D	270	0,685	2,980	Pentronic	
TBU10022	Ring 5	D	270	0,735	2,980	Pentronic	
TBU10023	Ring 5	D	270	0,785	2,980	Pentronic	
TBU10024	Ring 10	A	0	0,635	5,508	Pentronic	
TBU10025	Ring 10	A	0	0,735	5,508	Pentronic	
TBU10026	Ring 10	D	270	0,585	5,508	Pentronic	
TBU10027	Ring 10	D	270	0,685	5,508	Pentronic	
TBU10028	Ring 10	D	270	0,785	5,508	Pentronic	
TBU10029	Cyl. 3	A	0	0,785	6,317	Pentronic	
TBU10030	Cyl. 3	B	95	0,585	6,317	Pentronic	
TBU10031	Cyl. 3	C	185	0,585	6,317	Pentronic	
TBU10032	Cyl. 4	A	0	0,785	7,026	Pentronic	

**Table 4-2 Numbering and position of sensors for measuring total pressure (P) in the buffer on hole 1.**

Type and number	Block	Instrument position				Fabricator	Remark
		Direction	$\alpha$ degree	r m	z m		
PBU10001	Cyl. 1	Center	0	0,000	0,000	Geokon	In cement
PBU10002	Cyl. 1	Center	0	0,100	0,504	Geokon	
PBU10003	Cyl. 1	A	5	0,585	0,504	Kulite	Vertical
PBU10004	Cyl. 1	A	5	0,685	0,504	Kulite	Vertical
PBU10005	Cyl. 1	A	5	0,785	0,504	Kulite	Vertical
PBU10006	Cyl. 1	B	95	0,635	0,504	Geokon	
PBU10007	Cyl. 1	B	105	0,735	0,504	Geokon	
PBU10008	Cyl. 1	C	185	0,635	0,504	Geokon	
PBU10009	Cyl. 1	C	195	0,735	0,504	Geokon	
PBU10011	Ring 5	A	5	0,685	2,780	Geokon I	
PBU10012	Ring 5	A	5	0,785	3,030	Kulite	In the slot
PBU10013	Ring 5	B	95	0,585	2,780	Geokon I	
PBU10014	Ring 5	B	95	0,785	2,780	Geokon I	
PBU10015	Ring 5	C	185	0,535	3,030	Geokon I	In the slot
PBU10016	Ring 5	C	185	0,825	2,870	Kulite	In the slot
PBU10017	Ring 10	Center	0	0,050	5,558	Geokon	
PBU10019	Ring 10	A	5	0,685	5,558	Kulite	Vertical
PBU10020	Ring 10	A	5	0,785	5,558	Kulite	Vertical
PBU10021	Ring 10	B	90	0,635	5,558	Geokon	
PBU10022	Ring 10	B	100	0,735	5,558	Geokon	
PBU10023	Ring 10	C	190	0,735	5,558	Geokon	
PBU10024	Ring 10	C	180	0,635	5,558	Geokon	
PBU10025	Cyl. 3	Center	0	0,050	6,317	Kulite	Vertical
PBU10026	Cyl. 3	A	5	0,585	6,567	Geokon	
PBU10027	Cyl. 4	Center	0	0,050	7,076	Kulite	Vertical

*Table 4-3 Numbering and position of sensors for measuring pore water pressure (U) in the buffer in hole 1.*

Type and number	Block	Instrument position				Fabricator	Remark
		Direction	$\alpha$ degree	r m	z m		
UBU10001	Cyl. 1	Center	90	0,050	0,054	Kulite	
UBU10002	Cyl. 1	Center	90	0,050	0,254	Geokon	Horizontal
UBU10003	Cyl. 1	A	355	0,585	0,344	Geokon	
UBU10004	Cyl. 1	A	355	0,785	0,344	Kulite	
UBU10005	Ring 5	A	355	0,585	2,780	Geokon	
UBU10006	Ring 5	A	355	0,785	2,870	Kulite	
UBU10007	Ring 5	B	85	0,535	2,870	Kulite	In the slot
UBU10008	Ring 5	B	85	0,825	2,870	Kulite	In the slot
UBU10009	Ring 5	C	175	0,535	2,780	Geokon	In the slot
UBU10010	Ring 5	C	175	0,825	2,780	Geokon	In the slot
UBU10011	Ring 10	A	355	0,585	5,398	Kulite	
UBU10012	Ring 10	A	355	0,785	5,308	Geokon	
UBU10013	Cyl. 3	Center	90	0,050	6,317	Geokon	
UBU10014	Cyl. 4	Center	90	0,050	6,916	Geokon	

*Table 4-4 Numbering and position of instruments for measuring water content (W) in the buffer in hole 1.*

Type and number	Block	Instrument position				Fabricator	Remark
		Direction	$\alpha$ degree	r m	z m		
WBU10001	Cyl. 1	Center	180	0,050	0,054	Rotronic	
WBU10002	Cyl. 1	A	0	0,400	0,254	Rotronic	
WBU10003	Cyl. 1	Center	180	0,100	0,254	Rotronic	Horizontal
WBU10004	Cyl. 1	A	350	0,785	0,344	Vaisala	
WBU10005	Cyl. 1	A	350	0,685	0,344	Vaisala	
WBU10006	Cyl. 1	A	350	0,585	0,344	Vaisala	
WBU10007	Cyl. 1	B	80	0,585	0,344	Vaisala	
WBU10008	Cyl. 1	B	80	0,685	0,254	Rotronic	
WBU10009	Cyl. 1	B	80	0,785	0,254	Rotronic	
WBU10010	Cyl. 1	C	170	0,585	0,254	Rotronic	
WBU10011	Cyl. 1	C	170	0,685	0,254	Rotronic	
WBU10012	Cyl. 1	C	170	0,785	0,254	Rotronic	
WBU10013	Ring 5	A	350	0,585	2,870	Vaisala	
WBU10014	Ring 5	A	350	0,685	2,870	Vaisala	
WBU10015	Ring 5	A	350	0,785	2,870	Vaisala	
WBU10016	Ring 5	B	80	0,535	2,780	Rotronic	In the slot
WBU10017	Ring 5	B	80	0,685	2,780	Rotronic	
WBU10018	Ring 5	B	80	0,785	2,780	Rotronic	
WBU10019	Ring 5	C	180	0,535	2,870	Vaisala	In the slot
WBU10020	Ring 5	C	180	0,685	2,870	Vaisala	
WBU10021	Ring 5	C	180	0,785	2,780	Rotronic	
WBU10022	Ring 10	Center	0	0,050	5,418	Vaisala	
WBU10023	Ring 10	A	180	0,362	5,428	Vaisala	
WBU10024	Ring 10	A	350	0,585	5,398	Vaisala	
WBU10025	Ring 10	A	350	0,685	5,398	Vaisala	
WBU10026	Ring 10	A	350	0,785	5,398	Vaisala	
WBU10027	Ring 10	B	80	0,585	5,308	Rotronic	
WBU10028	Ring 10	B	80	0,685	5,308	Rotronic	
WBU10029	Ring 10	B	80	0,785	5,308	Rotronic	
WBU10030	Ring 10	C	170	0,585	5,398	Vaisala	
WBU10031	Ring 10	C	170	0,785	5,308	Rotronic	
WBU10032	Cyl. 3	Center	270	0,050	6,317	Vaisala	
WBU10033	Cyl. 3	A	350	0,585	6,317	Vaisala	
WBU10034	Cyl. 3	B	90	0,585	6,317	Vaisala	
WBU10035	Cyl. 3	C	180	0,585	6,317	Rotronic	
WBU10036	Cyl. 4	Center	180	0,050	6,916	Vaisala	
WBU10037	Cyl. 4	Center	270	0,050	6,756	Vaisala	

### 4.3 Position of each instrument in the bentonite in hole 3 (DA3575G01)

The instruments are located according to the same system as those in hole 1. The positions of each instrument are described in Tables 4-5 to 4-8.

*Table 4-5 Numbering and position of thermocouple sensors for measuring temperature (T) in the buffer in hole 3.*

Type and number	Block	Instrument position				Fabricator	Remark
		Direction	$\alpha$ degree	r m	z m		
TBU30001	Cyl. 1	Center	270	0,050	0,095	Pentronic	
TBU30002	Cyl. 1	Center	270	0,050	0,295	Pentronic	
TBU30003	Cyl. 1	Center	270	0,050	0,445	Pentronic	
TBU30004	Cyl. 1	A	355	0,635	0,445	Pentronic	
TBU30005	Cyl. 1	A	355	0,735	0,445	Pentronic	
TBU30006	Cyl. 1	B	85	0,685	0,445	Pentronic	
TBU30007	Cyl. 1	C	175	0,685	0,445	Pentronic	
TBU30008	Cyl. 1	D	270	0,585	0,445	Pentronic	
TBU30009	Cyl. 1	D	270	0,685	0,445	Pentronic	
TBU30010	Cyl. 1	D	270	0,785	0,445	Pentronic	
TBU30011	Ring 5	A	0	0,635	2,971	Pentronic	
TBU30012	Ring 5	A	0	0,735	2,971	Pentronic	
TBU30013	Ring 5	B	90	0,585	2,971	Pentronic	
TBU30014	Ring 5	B	90	0,685	2,971	Pentronic	
TBU30015	Ring 5	B	90	0,785	2,971	Pentronic	
TBU30016	Ring 10	A	329	0,410	5,394	Pentronic	Just above canister lid
TBU30017	Ring 5	C	175	0,685	2,971	Pentronic	
TBU30018	Ring 5	C	175	0,735	2,971	Pentronic	
TBU30019	Ring 5	D	270	0,585	2,971	Pentronic	
TBU30020	Ring 5	D	270	0,635	2,971	Pentronic	
TBU30021	Ring 5	D	270	0,685	2,971	Pentronic	
TBU30022	Ring 5	D	270	0,735	2,971	Pentronic	
TBU30023	Ring 5	D	270	0,785	2,971	Pentronic	
TBU30024	Ring 10	A	0	0,635	5,504	Pentronic	
TBU30025	Ring 10	A	0	0,735	5,504	Pentronic	
TBU30026	Ring 10	D	270	0,585	5,504	Pentronic	
TBU30027	Ring 10	D	270	0,685	5,504	Pentronic	
TBU30028	Ring 10	D	270	0,785	5,504	Pentronic	
TBU30029	Cyl. 3	A	0	0,785	6,314	Pentronic	
TBU30030	Cyl. 3	B	95	0,585	6,314	Pentronic	
TBU30031	Cyl. 3	C	185	0,585	6,314	Pentronic	
TBU30032	Cyl. 4	A	0	0,785	7,015	Pentronic	

**Table 4-6 Numbering and position of sensors for measuring total pressure (P) in the buffer in hole 3.**

Type and number	Block	Instrument position in block				Fabricator	Remark
		Direction	$\alpha$ degree	r mm	z mm		
PBU30001	Cyl. 1	Center	0	0	0	Geokon	In cement
PBU30002	Cyl. 1	Center	0	100	495	Geokon	
PBU30003	Cyl. 1	A	5	585	495	Kulite	Vertical
PBU30004	Cyl. 1	A	5	685	495	Kulite	Vertical
PBU30005	Cyl. 1	A	5	785	495	Kulite	Vertical
PBU30006	Cyl. 1	B	95	635	495	Geokon	
PBU30007	Cyl. 1	B	105	735	495	Geokon	
PBU30008	Cyl. 1	C	185	635	495	Geokon	
PBU30009	Cyl. 1	C	195	735	495	Geokon	
PBU30010	Ring 5	A	5	535	3021	Kulite	In the slot
PBU30011	Ring 5	A	5	685	2771	Geokon I	
PBU30012	Ring 5	A	5	825	3021	Kulite	In the slot
PBU30013	Ring 5	B	95	585	2771	Geokon I	
PBU30014	Ring 5	B	95	785	2771	Geokon I	
PBU30015	Ring 5	C	185	535	3021	Geokon I	In the slot
PBU30016	Ring 5	C	185	825	2971	Kulite	In the slot
PBU30017	Ring 10	Center	0	50	5556	Geokon	
PBU30018	Ring 10	A	5	585	5556	Kulite	Vertical
PBU30019	Ring 10	A	5	685	5556	Kulite	Vertical
PBU30020	Ring 10	A	5	785	5556	Kulite	Vertical
PBU30021	Ring 10	B	90	635	5556	Geokon	
PBU30022	Ring 10	B	100	735	5556	Geokon	
PBU30023	Ring 10	C	180	735	5556	Geokon	
PBU30024	Ring 10	C	190	635	5556	Geokon	
PBU30025	Cyl. 3	Center	0	50	6314	Kulite	Vertical
PBU30026	Cyl. 3	A	5	585	6564	Geokon	
PBU30027	Cyl. 4	Center	0	50	7065	Kulite	Vertical



*Table 4-7 Numbering and position of sensors for measuring pore water pressure (U) in the buffer in hole 3.*

Type and number	Block	Instrument position in block				Fabricator	Remark
		Direction	$\alpha$ degree	r mm	z mm		
UBU30001	Cyl. 1	Center	90	50	45	Kulite	
UBU30002	Cyl. 1	Center	90	100	245	Geokon	Horizontal
UBU30003	Cyl. 1	A	355	585	335	Geokon	
UBU30004	Cyl. 1	A	355	785	335	Kulite	
UBU30005	Ring 5	A	355	585	2771	Geokon	
UBU30006	Ring 5	A	355	785	2861	Kulite	
UBU30007	Ring 5	B	85	535	2861	Kulite	In the slot
UBU30008	Ring 5	B	85	825	2861	Kulite	In the slot
UBU30009	Ring 5	C	175	535	2771	Geokon	In the slot
UBU30010	Ring 5	C	175	825	2771	Geokon	In the slot
UBU30011	Ring 10	A	355	585	5396	Kulite	
UBU30012	Ring 10	A	355	785	5306	Geokon	
UBU30013	Cyl. 3	Center	90	50	6314	Geokon	
UBU30014	Cyl. 4	Center	90	50	6910	Geokon	

Table 4-8 Numbering and position of sensors for measuring water content (W) in the buffer in hole 3.

Type and number	Block	Instrument position				Fabricator	Remark
		Direction	$\alpha$ degree	r m	z m		
WBU30001	Cyl. 1	Center	180	0,050	0,045	Rotronic	
WBU30002	Cyl. 1	A	0	0,400	0,215	Rotronic	
WBU30003	Cyl. 1	Center	180	0,100	0,245	Rotronic	Horizontal
WBU30004	Cyl. 1	A	350	0,785	0,335	Vaisala	
WBU30005	Cyl. 1	A	350	0,685	0,335	Vaisala	
WBU30006	Cyl. 1	A	350	0,585	0,335	Vaisala	
WBU30007	Cyl. 1	B	80	0,585	0,335	Vaisala	
WBU30008	Cyl. 1	B	80	0,685	0,245	Rotronic	
WBU30009	Cyl. 1	B	80	0,785	0,245	Rotronic	
WBU30010	Cyl. 1	C	170	0,585	0,245	Rotronic	
WBU30011	Cyl. 1	C	170	0,685	0,245	Rotronic	
WBU30012	Cyl. 1	C	170	0,785	0,245	Rotronic	
WBU30013	Ring 5	A	350	0,585	2,861	Vaisala	
WBU30014	Ring 5	A	350	0,685	2,861	Vaisala	
WBU30015	Ring 5	A	350	0,785	2,861	Vaisala	
WBU30016	Ring 5	B	80	0,535	2,771	Rotronic	In the slot
WBU30017	Ring 5	B	80	0,685	2,771	Rotronic	
WBU30018	Ring 5	B	80	0,785	2,771	Rotronic	
WBU30019	Ring 5	C	180	0,535	2,861	Vaisala	In the slot
WBU30020	Ring 5	C	180	0,685	2,861	Vaisala	
WBU30021	Ring 5	C	180	0,785	2,771	Rotronic	
WBU30022	Ring 10	Center	180	0,050	5,416	Vaisala	
WBU30023	Ring 10	A	352	0,262	5,396	Vaisala	
WBU30024	Ring 10	A	350	0,585	5,396	Vaisala	
WBU30025	Ring 10	A	350	0,785	5,396	Vaisala	
WBU30026	Ring 10	A	350	0,685	5,396	Vaisala	
WBU30027	Ring 10	B	80	0,585	5,306	Rotronic	
WBU30028	Ring 10	B	80	0,685	5,306	Rotronic	
WBU30029	Ring 10	B	80	0,785	5,306	Rotronic	
WBU30030	Ring 10	C	170	0,585	5,396	Vaisala	
WBU30031	Ring 10	C	170	0,785	5,306	Rotronic	
WBU30032	Cyl. 3	Center	180	0,050	6,314	Vaisala	
WBU30033	Cyl. 3	A	350	0,585	6,314	Vaisala	
WBU30034	Cyl. 3	B	90	0,585	6,314	Vaisala	
WBU30035	Cyl. 3	C	180	0,585	6,314	Rotronic	
WBU30036	Cyl. 4	Center	180	0,050	6,910	Vaisala	
WBU30037	Cyl. 4	Center	270	0,050	6,750	Vaisala	

#### **4.4 Instruments on the canister surface in holes 1-4**

The canisters are instrumented with optical fibre cables on the copper surface.

Figure 4-2 shows how two optical fibre cables are placed on the canister surface. Both ends of a cable are used for measurements. This means that the two cables are used for four measurements.

Instrumentation of Optical fibre cables described in detail in report SKB PR-02-03 (Collin and Börjesson 2001)

With this laying the cables will enter and exit the surface at almost the same position. Curvatures are shaped as a quarter circle with a radius of 20 cm. The cables are placed in a milled out channel on the surface. The channels have a width and a depth of just above 2 mm.

In addition to the optical cables one thermocouple (TBU 10006) is fixed to the lid of the canister in deposition hole 2 (see Table 4-1).

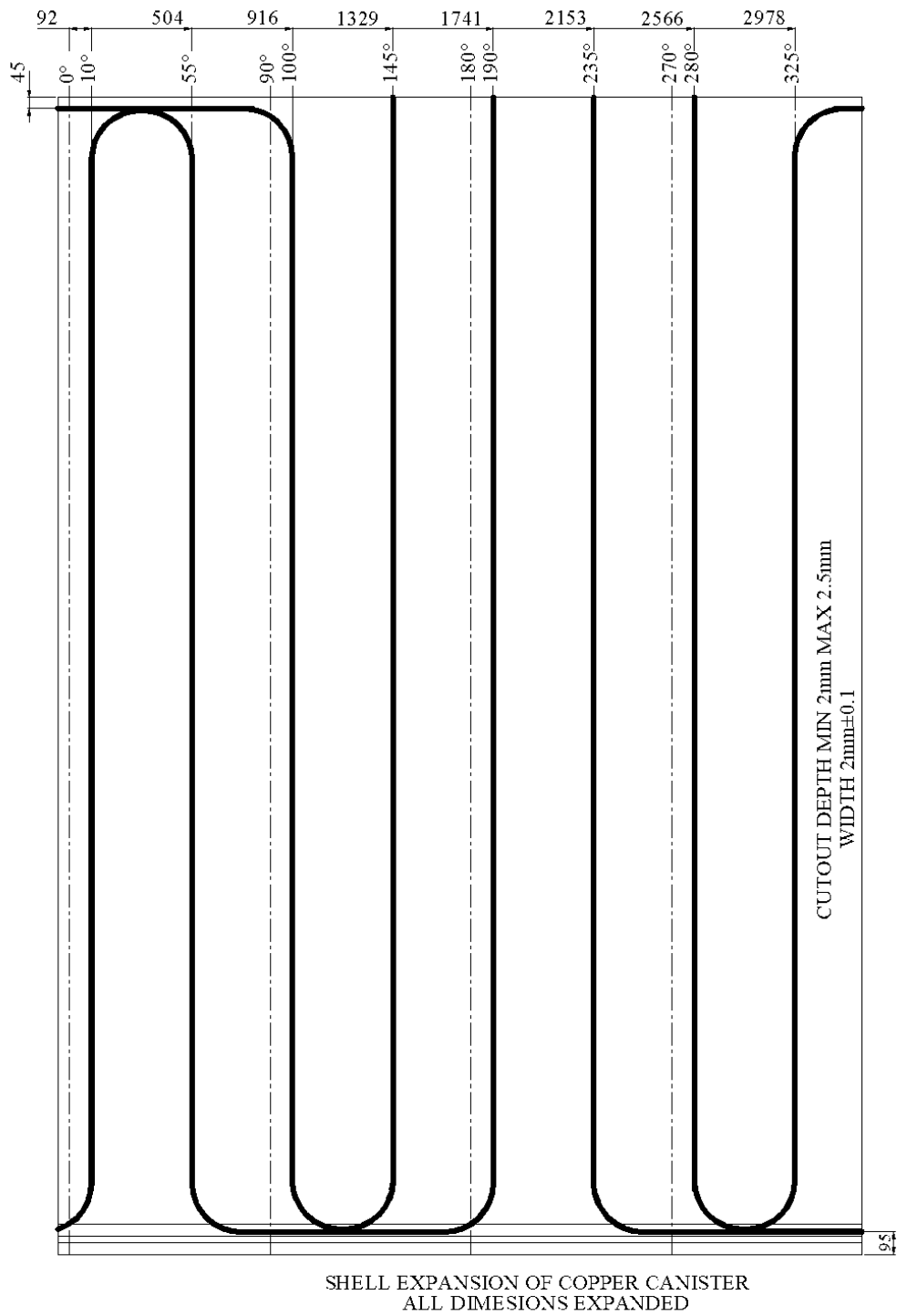

Figure 4-2 Laying of the optical fibre cables with protection tube of Inconel 625 (outer diameter 2 mm) for measurement of the canister surface temperature (surface unfolded).

## 4.5 Position of temperature sensors in the rock

The positions of the temperature sensors in the rock are termed in the same way as the sensors in the buffer in the deposition holes. Figure 4-3 and figure 4-4 shows an overview of the temperature sensors placed in the rock. The sensors are assigned to the closest deposition hole.

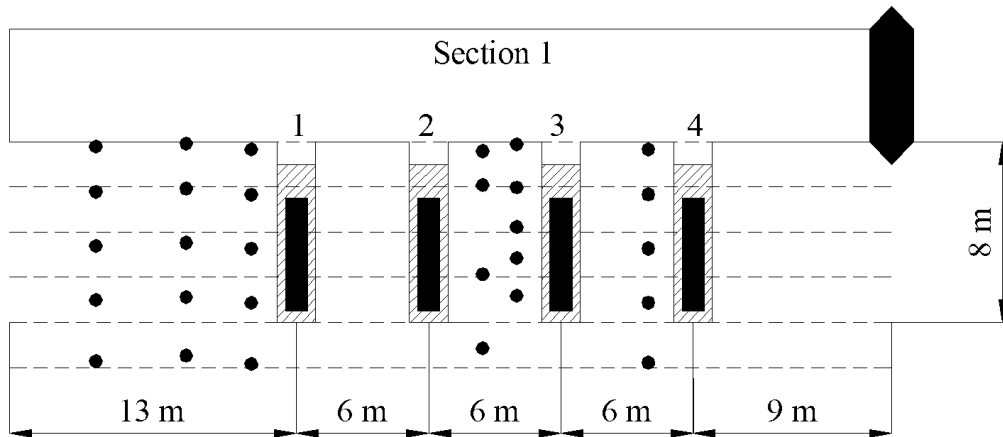

Figure 4-3 Overview of the temperature sensors in the rock. Length section.

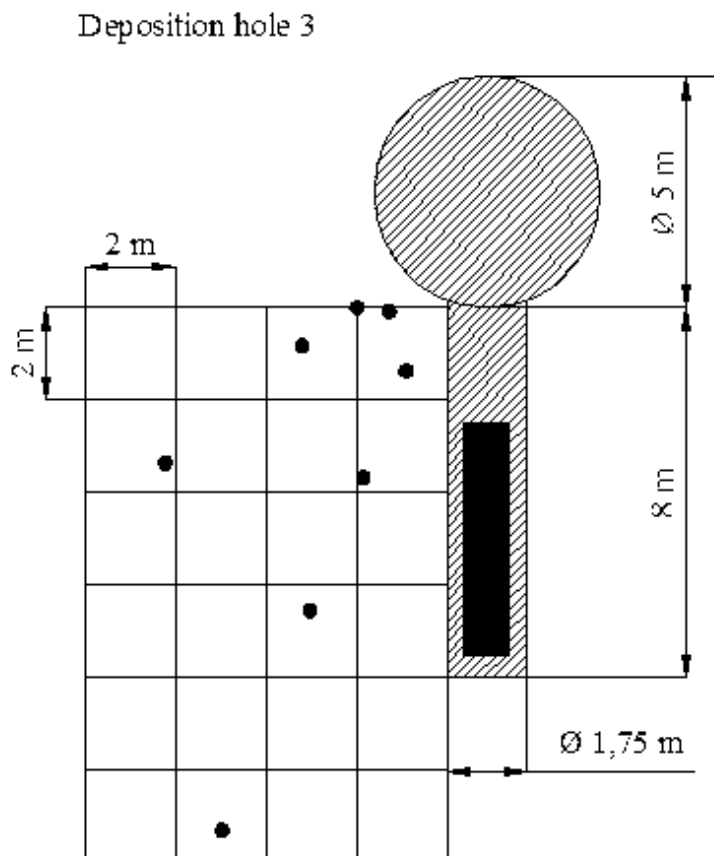

Figure 4-4 Overview of the temperature sensors in the rock. Cross section around hole3 (towards the end of the tunnel).

Table 4-9 Numbering and position of temperature sensors in the rock.

Instrument position in rock				
Type and number	$\alpha$ degree	r m	z m	Fabricator
Measured from DA3587G01(Hole 1)				
TROA0350	360	9,080	7,785	Pentronic
TROA0340	360	9,080	5,785	Pentronic
TROA0330	360	9,080	3,385	Pentronic
TROA0320	0	9,080	0,986	Pentronic
TROA0310	0	9,081	-1,714	Pentronic
TROA0650	360	4,990	7,922	Pentronic
TROA0640	360	4,982	5,922	Pentronic
TROA0630	360	4,972	3,522	Pentronic
TROA0620	360	4,961	1,122	Pentronic
TROA0610	360	4,951	-1,478	Pentronic
TROA1050	359	2,014	7,663	Pentronic
TROA1040	359	2,022	5,663	Pentronic
TROA1030	359	2,032	3,263	Pentronic
TROA1020	359	2,042	0,863	Pentronic
TROA1010	359	2,053	-1,837	Pentronic
Measured from DA3581G01(Hole 2)				
TROA1840	179	2,403	7,584	Pentronic
TROA1830	179	2,427	6,084	Pentronic
TROA1820	179	2,489	2,135	Pentronic
TROA1810	179	2,541	-1,165	Pentronic
Measured from DA3575G01(Hole 3)				
TROA2150	134	3,287	7,956	Pentronic
TROA2140	1	1,993	5,977	Pentronic
TROA2130	1	1,975	4,228	Pentronic
TROA2120	2	1,961	2,838	Pentronic
TROA2110	3	1,944	1,168	Pentronic
TROA1850	360	2,013	7,887	Pentronic
TROA2330	90	2,192	7,922	Pentronic
TROA2320	90	1,786	6,630	Pentronic
TROA2310	109	7,111	4,638	Pentronic
TROA2440	124	4,090	7,172	Pentronic
TROA2430	90	2,735	4,317	Pentronic
TROA2420	89	3,912	1,449	Pentronic
TROA2410	89	5,86	-3,297	Pentronic
Measured from DA3569G01 (Hole 4)				
TROA3050	359	2,013	7,665	Pentronic
TROA3040	359	2,020	5,665	Pentronic
TROA3030	358	2,030	3,265	Pentronic
TROA3020	357	2,040	0,865	Pentronic
TROA3010	357	2,051	-1,784	Pentronic

## 4.6 Strategy for describing the position of each device in the backfill in section 1

The principles of terming the instruments are shown in the quick guide on page 9. Every instrument is named with a unique name consisting of 1 letter describing the type of measurement, 2 letters describing where the measurement takes place (buffer, backfill, rock or canister) and 5 figures specifying the instrument according to separate lists (see Tables 4-9 to 4-12). Every instrument position is then described with three coordinates according to Figure 2-2. The  $x$ -coordinate is the horizontal distance from the centre of the tunnel and the  $z$ -coordinate is the vertical distance from the centre of the tunnel. The  $y$ -coordinate is the same as in the tunnel coordinate system, i.e.,  $y=3599$  corresponds to the end of the tunnel.

The backfill is mainly instrumented in vertical sections straight above and between the deposition holes (Figures 4-4 and 4-5).

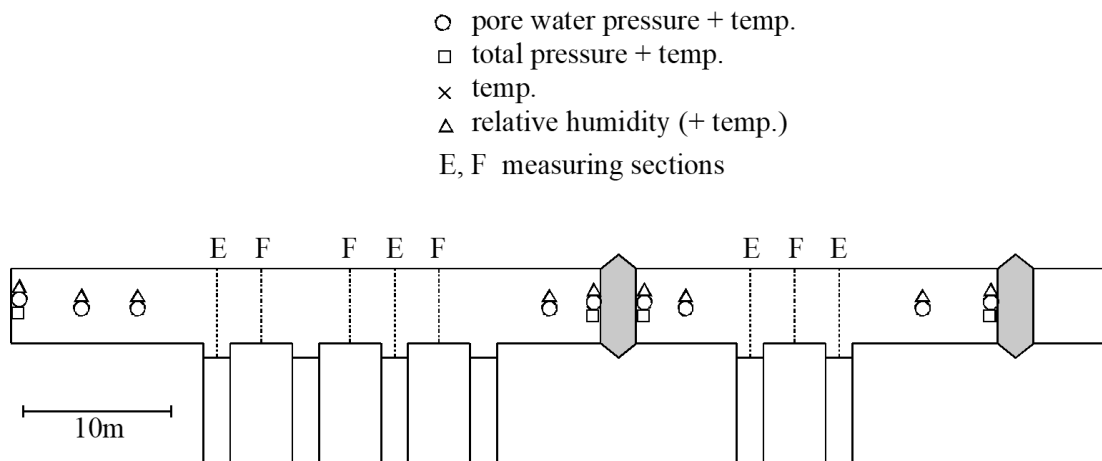

*Figure 4-5 Schematic view over the instrumentation of the backfill.*

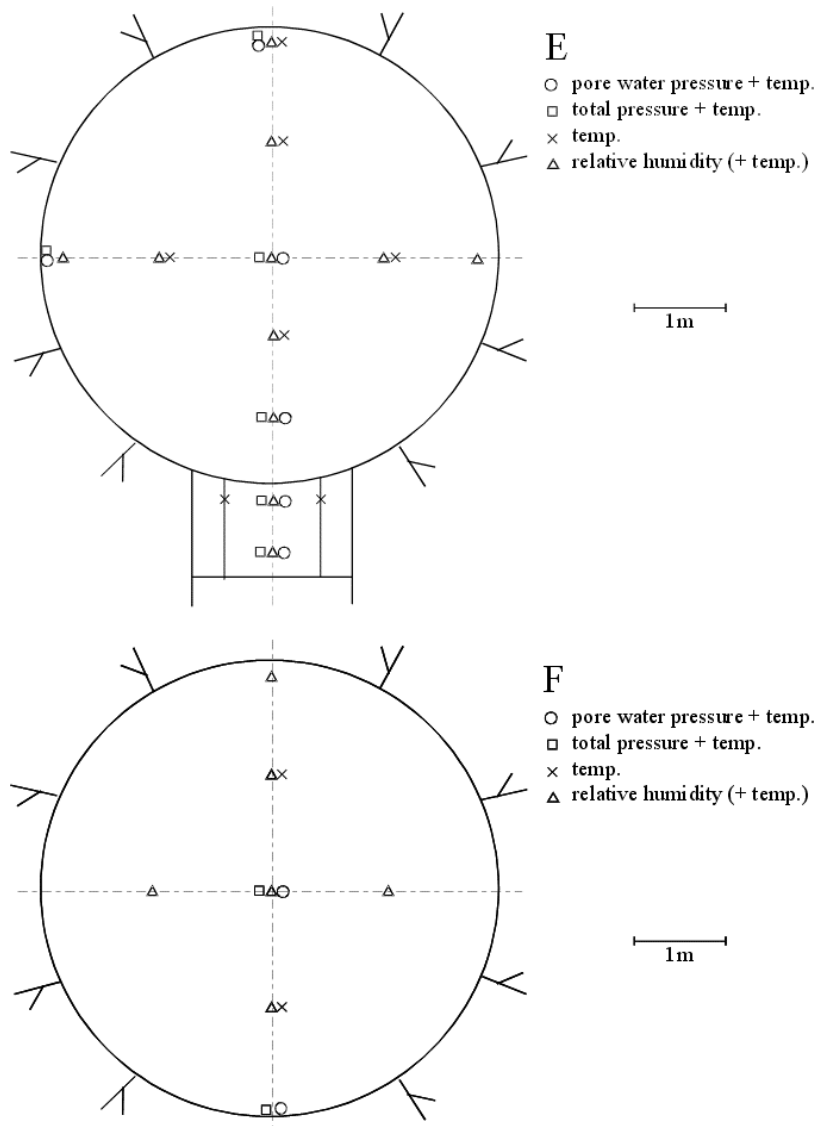

*Figure 4-6 Schematic view over the sensors positions in the different sections. (Towards the end of the tunnel).*



## 4.7 Position of each instrument in the backfill

The positions of each sensor are described in Tables 4-10 to 4-13.

*Table 4-10 Numbering and position of thermocouple sensors for measuring temperature (T) in the backfill.*

Type and number	Instrument position			Fabricator	Remark
	Section	x	z		
		m	m	m	
TBA10001	E, over dep. hole 1	-1,3	-0,1	3 587	Pentronic
TBA10002	E, over dep. hole1	0,1	1,3	3 587	Pentronic
TBA10003	E, over dep. hole1	0,0	-0,8	3 587	Pentronic
TBA10004	E, over dep. hole1	-0,5	-2,6	3 587	Pentronic
TBA10005	E, over dep. hole1	0,5	-2,6	3 587	Pentronic
TBA10006	E, over dep. hole1	-0,1	2,3	3 587	Pentronic
TBA10007	E, over dep. hole1	1,3	-0,1	3 587	Pentronic
TBA10008	F, between dep. hole1 and 2	0,0	1,3	3 584	Pentronic
TBA10009	F, between dep. hole1 and 2	-0,1	-1,3	3 584	Pentronic
TBA10010	F, between dep. hole2 and 3	0,0	1,2	3 578	Pentronic
TBA10011	F, between dep. hole2 and 3	0,0	-1,2	3 578	Pentronic
TBA10012	E, over dep. hole3	-0,1	2,3	3 575	Pentronic
TBA10013	E, over dep. hole3	0,0	1,3	3 575	Pentronic
TBA10014	E, over dep. hole3	0,0	-0,9	3 575	Pentronic
TBA10015	E, over dep. hole3	-0,5	-2,6	3 575	Pentronic
TBA10016	E, over dep. hole3	0,5	-2,6	3 575	Pentronic
TBA10017	E, over dep. hole3	-1,3	0,0	3 575	Pentronic
TBA10018	E, over dep. hole3	1,3	0,0	3 575	Pentronic
TBA10019	F, between dep. hole3 and 4	0,0	1,2	3 572	Pentronic
TBA10020	F, between dep. hole3 and 4	0,0	-1,3	3 572	Pentronic

*Table 4-11 Numbering and position of sensors for measuring total pressure (P) in the backfill.*

Type and number	Instrument position			Fabricator	Remark	
	Section	x	z			y
		m	m			m
PBA10001	Inner part	0,2	0,1	3589	Kulite	
PBA10002	E, over dep. hole1	0,0	0,0	3587	Geokon	
PBA10003	E, over dep. hole1	0,0	-1,8	3587	Geokon	
PBA10004	E, over dep. hole1	0,0	-2,6	3587	Geokon	
PBA10005	E, over dep. hole1	0,0	-3,1	3587	Kulite	
PBA10006	E, over dep. hole1	-2,3	0,1	3587	Kulite	
PBA10007	E, over dep. hole1	0,2	2,3	3587	Kulite	
PBA10008	F, between dep. hole1 and 2	0,0	0,0	3584	Geokon	
PBA10009	F, between dep. hole1 and 2	-0,1	-1,8	3584	Geokon	
PBA10010	F, between dep. hole2 and 3	0,0	-0,2	3578	Kulite	
PBA10011	F, between dep. hole2 and 3	0,0	-2,3	3578	Kulite	
PBA10013	E, over dep. hole3	0,0	-1,8	3575	Kulite	
PBA10015	E, over dep. hole3	0,0	-3,1	3575	Geokon	
PBA10016	E, over dep. hole3	-2,3	0,0	3575	Geokon	
PBA10017	E, over dep. hole3	0,0	0,0	3575	Geokon	
PBA10018	F, between dep. hole3 and 4	0,0	0,0	3572	Geokon	
PBA10019	F, between dep. hole3 and 4	0,0	-2,3	3572	Geokon	
PBA10020	In front of plug	0,0	0,0	3561	Kulite	

*Table 4-12 Numbering and position of sensors for measuring pore water pressure (U) in the backfill.*

Type and number	Instrument position			Fabricator	Remark
	Section	x	z		
		m	m	m	
UBA10001	Inner part	-0,2	-0,1	3589	Kulite
UBA10002	Inner part	0,0	0,0	3592	Geokon
UBA10003	Inner part	-0,2	-0,1	3590	Geokon
UBA10004	E, over dep. hole1	0,0	-0,1	3587	Geokon
UBA10005	E, over dep. hole1	-0,2	-1,8	3587	Kulite
UBA10006	E, over dep. hole1	0,1	-2,6	3587	Kulite
UBA10007	E, over dep. hole1	0,4	-3,2	3587	Kulite
UBA10008	E, over dep. hole1	-2,3	0,0	3587	Geokon
UBA10009	E, over dep. hole1	0,0	2,3	3587	Geokon
UBA10010	F, between dep. hole1 and 2	0,0	0,0	3584	Kulite
UBA10011	F, between dep. hole1 and 2	0,1	-1,8	3584	Kulite
UBA10012	F, between dep. hole2 and 3	0,0	-0,2	3578	Kulite
UBA10013	F, between dep. hole2 and 3	0,0	-2,3	3578	Kulite
UBA10014	E, over dep. hole3	0,0	0,0	3575	Kulite
UBA10015	E, over dep. hole3	0,0	-1,8	3575	Geokon
UBA10016	E, over dep. hole3	0,3	-2,6	3575	Geokon
UBA10017	E, over dep. hole3	-0,1	-3,1	3575	Geokon
UBA10018	E, over dep. hole3	-2,3	0,0	3575	Geokon
UBA10019	E, over dep. hole3	0,0	0,0	3575	Geokon
UBA10020	F, between dep. hole3 and 4	0,0	0,0	3572	Kulite
UBA10021	F, between dep. hole3 and 4	0,0	-2,3	3572	Kulite
UBA10022	In front of plug	0,0	0,0	3565	Kulite
UBA10023	In front of plug	0,1	0,0	3562	Kulite

Table 4-13 Numbering and position of sensors for measuring relative humidity (W) in the backfill.

Type and number	Instrument position			Fabricator	Remark
	Section	x	z		
		m	m	m	
WBA10001	Inner part	0,0	0,0	3589	Wescor
WBA10002	Inner part	0,0	0,0	3592	Wescor
WBA10003	Inner part	0,1	-0,1	3590	Wescor
WBA10004	E, over dep. hole1	0,3	2,3	3587	Wescor
WBA10005	E, over dep. hole1	0,0	1,3	3587	Wescor
WBA10006	E, over dep. hole1	0,0	0,1	3587	Wescor
WBA10007	E, over dep. hole1	0,1	-0,8	3587	Wescor
WBA10008	E, over dep. hole1	0,0	-1,7	3587	Wescor
WBA10009	E, over dep. hole1	-0,1	-2,6	3587	Wescor
WBA10010	E, over dep. hole1	-0,5	-3,1	3587	Wescor
WBA10011	E, over dep. hole1	-2,3	-0,1	3587	Wescor
WBA10012	E, over dep. hole1	-1,3	0,0	3587	Wescor
WBA10013	E, over dep. hole1	1,3	0,0	3587	Wescor
WBA10014	E, over dep. hole1	2,3	0,0	3587	Wescor
WBA10015	F, between dep. hole1 and 2	0,0	1,3	3584	Wescor
WBA10016	F, between dep. hole1 and 2	0,0	2,3	3584	Wescor
WBA10017	F, between dep. hole1 and 2	0,0	0,0	3584	Wescor
WBA10018	F, between dep. hole1 and 2	0,0	-1,3	3584	Wescor
WBA10019	F, between dep. hole1 and 2	-1,3	0,0	3584	Wescor
WBA10020	F, between dep. hole1 and 2	1,3	0,0	3584	Wescor
WBA10021	F, between dep. hole2 and 3	0,0	2,3	3578	Wescor
WBA10022	F, between dep. hole2 and 3	0,0	1,2	3578	Wescor
WBA10023	F, between dep. hole2 and 3	0,0	-0,2	3578	Wescor
WBA10024	F, between dep. hole2 and 3	0,0	-1,2	3578	Wescor
WBA10025	F, between dep. hole2 and 3	-1,3	0,0	3578	Wescor
WBA10026	F, between dep. hole2 and 3	1,3	0,0	3578	Wescor
WBA10027	E, over dep. hole3	0,0	2,5	3575	Wescor
WBA10028	E, over dep. hole3	0,0	1,3	3575	Wescor
WBA10029	E, over dep. hole3	0,0	0,0	3575	Wescor
WBA10030	E, over dep. hole3	0,0	-0,9	3575	Wescor
WBA10031	E, over dep. hole3	0,0	-1,6	3575	Wescor
WBA10032	E, over dep. hole3	-0,3	-2,6	3575	Wescor
WBA10033	E, over dep. hole3	0,1	-3,1	3575	Wescor
WBA10034	E, over dep. hole3	-2,3	0,0	3575	Wescor
WBA10035	E, over dep. hole3	-1,3	0,0	3575	Wescor
WBA10036	E, over dep. hole3	1,3	0,0	3575	Wescor
WBA10037	E, over dep. hole3	2,3	0,0	3575	Wescor
WBA10038	F, between dep. hole3 and 4	0,0	2,3	3572	Wescor
WBA10039	F, between dep. hole3 and 4	0,0	1,2	3572	Wescor
WBA10040	F, between dep. hole3 and 4	0,0	0,0	3572	Wescor
WBA10041	F, between dep. hole3 and 4	0,0	-1,3	3572	Wescor
WBA10042	F, between dep. hole3 and 4	-1,3	0,0	3572	Wescor
WBA10043	F, between dep. hole3 and 4	1,3	0,0	3572	Wescor
WBA10044	In front of plug	0,0	0,0	3565	Wescor
WBA10045	In front of plug	-0,1	0,0	3562	Wescor

## 5 Results and comments for Section 1

### 5.1 General

In this chapter short comments on general trends in the measurements are given. Sensors that are not delivering reliable data or no data at all are noted and comments on the data collection in general are given.

The heating of the canister in hole1 started with an applied constant power of 1800 W at 2001-09-17. This date is also marked as start date for the test. The backfilling started 2001-09-03 and was finished 2001-11-20 and the plug was cast at 2001-12-14. In order to simulate the radioactive decay, the power was decreased 20 W one year after start of the first heater. At the beginning of September 2004, the power was decreased with about 30 W to 1710 W in deposition holes 1-4. Table 5-1 shows some important dates for section 1. At the beginning of November 2004, the drainage of the inner part of Section 1 and the drainage trough the outer plug was closed. At the beginning of December 2004 damages on the cables for the installed heaters in one of the canisters in Section 1 (No 1) and one in Section 2 (No 6) were observed. The damages were probably caused by the high water pressure in the buffer and backfill. It was then decided to switch off the power to all canisters. This was done on December 2. The drainage of the tunnel was opened on December 6 and investigations of the damaged cables were initialized. The power to all the canisters, except for canister 2, was on December 15 switched on. The damages on heaters in canister 2 were so severe that it was impossible to apply any power on this canister. The drainage of the tunnel was kept open.

In December 2005, 2006, 2007 and in January 2009 and 2010 the power to the canisters was reduced with about 30 W. The power in hole 3 has switched off (2015-10-06/ day 5132).

A change in power was made June 23, 2003, due to additional calculations of the power from measurement of the energy. The power of the canisters was adjusted to 1800 W. The most significant change was made for canister 2 (See section 5.4.1 and Appendix 3 page 72).

After the retrieval of the outer section, validation tests of the total pressure sensors of type Geocon were made. It was then discovered that, the up to 2012-01-01 used calibration values (linear equation) gave inaccurate readings of the total pressure. The improvements of the readings were large when a polynomial calibration equation was used instead. At the presentation of the data in this report the polynomial equation was used.

At present about 64 (excluding water pressure sensors in the rock and the displacement sensors for the canister) out of totally 363 installed sensors are still working.

In the end of year 2021 are 19 pressure sensors, 15 temperature sensors in the backfill still working. Only 2 pressure sensors still working in the buffer. Also 28 temperature sensors still working in the rock around deposition hole.

In Figure 5-1 the numbers of still working sensors in the buffer and the backfill of Section 1 are plotted as function of time from September 2001. The figure shows that many of the broken sensors are RH-sensors and thermocouples (in deposition hole). The figure also shows that the numbers of broken sensors increased after the closing of the drainage of the tunnel.

**Table 5-1 Key dates for section 1.**

Activity	Days after start	Date
Start backfilling		3/9 2001
Start heating canister 1	0	17/9 2001
Start heating canister 2	7	24/9 2001
Start heating canister 3	24	11/10 2001
Start heating canister 4	35	22/10 2001
Finish backfilling	64	20/11 2001
Plug casting	88	14/12 2001
Decreased power (-20 W)	365	17/9 2002
The power to all canisters was adjusted to 1800 W	644	23/6 2003
Decreased power (-40 W)	718	5/9 2003
Decreased power (-30 W)	1087	8/9 2004
The drainage of tunnel was closed	1110	1/10 2004
The power to all canisters was switched off	1172	2/12 2004
The drainage of the tunnel was opened	1176	6/12 2004
The power to the canisters was switched on	1185	15/12 2004
Leakage from a packer placed in a borehole in Section I of the tunnel	1676	20/4 2006
A packer installed in the rock was broken	1704	18/5 2006
Decreased power (-30 W)	1911	21/12 2006
The excavation of a new tunnel near by the Prototype-tunnel	2022-2051	April 2007
Decreased power (-30 W)	2276	11/12 2007
Decreased power (-30 W)	2691	29/1 2009
Decreased power (-30 W)	3048	21/1 2010
Start of the dismantling of the outer plug	3360	29/11 2010
The dismantling of the Section2 has finished	3764	20/12 2011
Decreased power in the canister 1 (-120W)	4188	6/3 2013
Decreased power in the canister 3 (-1060W)	4263	20/5 2013
Decreased power in the canister 1 (-290W)	4546	27/2 2014
A packer installed in the rock was damaged	4600	22/4 2014
Decreased power in the canister 3 (-130W)	4601	23/4... 2014
A packer installed in the rock was damaged	4834	6/12 2014
The power to the canister 4 was switched off	4896	10/2 2015
The power to the canister 4 was switched on	4898	12/2 2015
The power to the canister 4 was switched off	4900	14/2 2015
The power to the canister 4 was switched on	4902	16/2 2015
The power to the canister 3 was switched off	5055	21/7 2015
The power to the canister 3 was switched on	5072	7/8 2015
The power to the canister 3 was switched off	5133	7/10 2015
The power to the canister 4 was switched off	5149	23/10 2015
The power to the canister 4 was switched on	5150	24/10 2015
The power to the canister 4 was switched off	5496	4/10 2016

---

Decreased power in the canister 4 (-950W)	5499	7/10	2016
Decreased power in the canister 4 (-280W)	5533	10/11	2016
Decreased power in the canister 1(-300 W)	5975	26/1	2018
Increased power in the canister 4 (280W)	6239	17/10.	2018
Decreased power in the canister 1(-300 W)	6244	22/10.	2018
Decreased power in the canister 1(-270 W)	6254	1/11	2018
The power to the canister 1 was switched off	6665	17/12	2019
Decreased power in the canister 4 (-280 W)	7303	15/9	2021

---

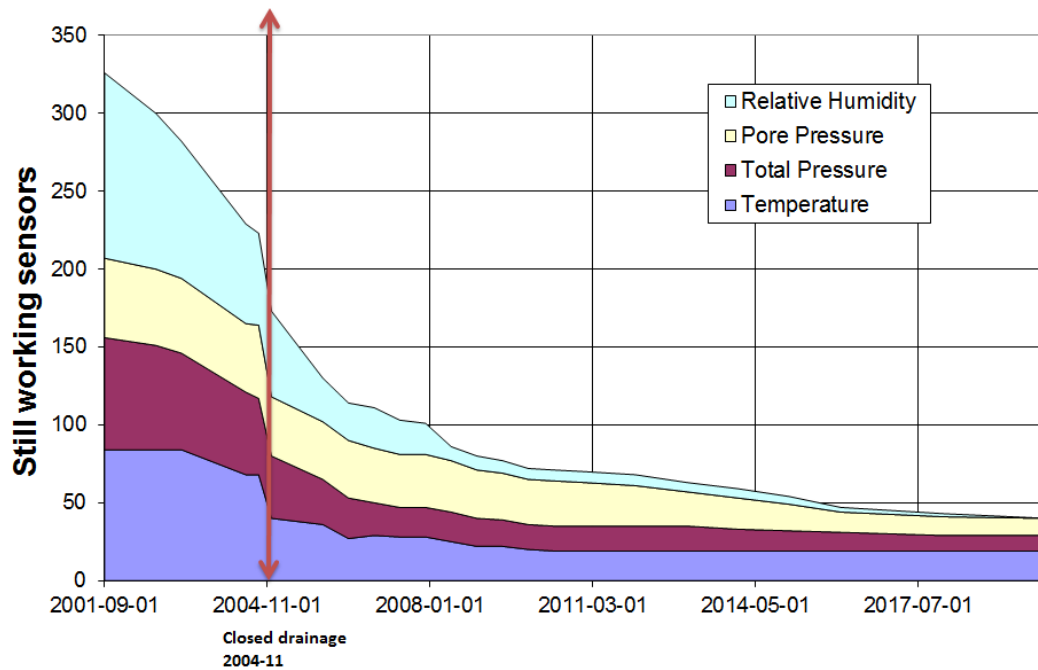

*Figure 5-1 The number of still working sensors placed in the buffer and backfill in Section 1 as function of date. The coloured fields are representing the four types of installed sensors.*

The measured processes were slow up to about 20 days after the drainage of the tunnel was closed. Very small changes of the measured parameters occurred up to that date. After that the readings from some of the total and pore pressure sensors placed in the buffer reacted strongly (quick increase in pressure). Also, the total and pore pressure sensors placed in the backfill recorded high pressures caused by the closing of the drainage. After the reopening of the drainage of the tunnel, both the pore pressures and the total pressures in the backfill were stabilized on almost the same level as before the closing of the drainage. At around day 1670 both the total pressure sensors and the pore pressure sensors are measuring an increase in pressure. This is caused by a failure in one packer placed in the rock at the inner part of the tunnel causing an increase in out flow of water from the inner section from about 1.5 l/min to more than 9 l/min.

A slow but obvious wetting of the backfill is noted until about 20 days after the closing of the drainage. After that a strong increase of the wetting rate was monitored by several psychrometers. The measurement of the temperature on the canister surface with the optical system has stopped functioning.



## **5.2 Deposition hole 1**

### **5.2.1 Total pressure**

#### **Geocon (Appendix 1\pages 43-44)**

The measured pressure range is from 1.4 to 7.5 MPa. The highest pressure is indicated from the peripheral sensors in the bottom block (C1). Four sensors in block R5 and block R10 yielded a high increase in total pressure when the drainage of the tunnel was closed. Most of the sensors yielded a drop in pressure when the heaters were switched off and the drainage of the tunnel was opened again and an increase in pressure when the heaters were switched on again. All the installed sensors are out of order.

#### **Kulite (Appendix 1\page 44)**

The highest pressure 7 MPa is indicated from the peripheral sensor (PBU 10012) in block R5. Three of the installed sensors indicated a rapid increase in pressure when the drainage of the tunnel was closed followed by a drop in pressure when the power was switched off and the drainage was reopened. After the power was switched on the pressure increased to the same level as before the closing of the drainage. Two sensors were not installed and all seven of the installed sensors are out of order.

### **5.2.2 Relative humidity**

#### **Vaisala (Appendix 1\pages 45-46)**

Since temperature is also measured with all relative humidity sensors, the diagrams include those measured temperatures. The temperature measurements start at about 16 degrees while the RH measurements start at about 70 % RH.

The sensors placed above the canister (in Cylinder 3 and 4) are indicating that these sensors have reached 100 relative humidity at day 4740. Sixteen sensors are out of order, most of them due to high water saturation of the buffer.

#### **Rotronic (Appendix 1\pages 47-48)**

All Rotronic sensors placed between the canister and the rock measured RH higher than 90 % within 200 days after the start of the test. Two of the sensors placed in the central part of block C1 indicated a drying of the bentonite (decreasing in RH from about 75 %) up to the time when they stopped working (after about 1000 days). All the installed sensors have stopped giving reliable RH values, most of them due to high water saturation of the buffer.

### **5.2.3 Pore water pressure**

#### **Geocon (Appendix 1\page 49)**

The highest pressures 0.5-1.6 MPa are measured near the canister surface in block R5 (UBU10005) and in the periphery of block R5 (UBU10010). Two sensors in block C1 are also recording an increasing pressure (UBU10002, UBU10003) while the rest of the sensors are measuring very low pressures at the last reading before, they were broken (day 3639). All sensors are out of order.

#### **Kulite (Appendix 1\page 50)**

Rather high-water pressures have been measured by three sensors located in block R5 (1.2 – 3.5 MPa). One sensor placed in the outer slot started to react about 50 days after the start of the measurement. The pore pressure measured with two of the sensors reacted strongly during the period when the drainage of the tunnel was closed and during the period when the power to the canister was switched off. The sensors measured an increase of the pressure with about 0.1 MPa after the middle of May 2007. This change in pressure is probably caused by the preparation work done for a new tunnel near by the Prototype tunnel. All the installed sensors have stopped giving reliable values.

### **5.2.4 Temperature in the buffer (Appendix 1\pages 50-53)**

The measured temperature after the power to the canister was switched on again ranges from 28.0 °C (in the periphery of the upper bentonite cylinder C4) to 70.0 °C in block R5 close to the canister.

Highest temperature gradient measured in the buffer is 0.57 °C /cm (block R5). All these thermocouple sensors are out of order. The temperature in the buffer is also measured with the Geocon sensors (from day 1350).

### **5.2.5 Canister power in dep. hole 1 (Appendix 1\page 55)**

The power of the canister in whole 1 was kept constant during one year at 1800 W since the start 2001-09-17. After one year the power was decreased with about 20 W.

After another year the power was decreased with about 40 W. The next reduction of power was made at the beginning of September year 2004 (about 30 W). The power of the canister in hole 1 was about 1710 W after this reduction. During the period between December 6 and December 15, 2004, the power to the canister was switched off. After that period the power was adjusted to about 1710 W again. At the beginning of December 2005, 2006, 2007 and January 2009 and 2010 the power was decreased with 30 W. After these reductions the power was about 1560 W until 2013-03-06 (day 4188) when the power has reduced to about 1440 W due to electrical heater failure. The power has reduced to about 1150 W from 2014-02-27 (day 4546) due to electrical heater failure. The power also has reduced to about 300 W due to several electrical heater failures.

The power has switched off at 2019-12-17(day 6665) due to all electrical heater failures.

### **5.2.6 Temperature on the canister surface (Appendix 1\page 56)**

The first diagram shows the maximum temperature, measured with the optical cables placed on the surface of the canister, plotted as function of time. The maximum measured temperature on the canister surface is about 75 °C. With no damages on the optical cables this plot should have four curves. Only one curve with relevant values is plotted up to December 24 which indicates that the optical cables are damaged. The second diagram shows the distribution of the temperature along the optical cables on December 1, 2004. The length of the cables on the canister surface is about 20 m. The variation of a few degrees is caused by the difference in temperature in the centre and ends of the canister. On December 15, 2004, the optical system for measuring the temperature on this canister stopped functioning.

## **5.3 Deposition hole 3**

### **5.3.1 Total pressure**

#### **Geocon (Appendix 2\pages 57-58)**

Most of the sensors placed in block C1 and block R10 yielded an increase in total pressure when the drainage of the tunnel was closed. The total pressures measured in this deposition hole are significantly lower than those measured in deposition hole 1. Sensor PBU30009 placed in block C1 yielded about 9.5MPa in total pressure at 2020-02-10 when the sensor stopped to working. Sensor PBU30015 close to canister lid in ring5 yield about 2.3MPa in total pressure in the end of this measuring period. Thirteen sensors are out of order.

#### **Kulite (Appendix 2\pages 58-59)**

The highest pressure, 2.0 MPa, is indicated from the peripheral placed sensors in block C1. Also, two sensors placed in block R10 have measured a pressure higher than 1.5 MPa. The sudden change in pressure which occurred around day 180 was probably caused by early data logger problems. Eleven sensors are out of order.

### **5.3.2 Relative humidity**

#### **Vaisala (Appendix 2\pages 59-61)**

A significant drying of the bentonite close to the top of the canister was observed by the two sensors WBU30022 and WBU30023 after start of heater in hole3. After the closing of the drainage both sensors indicated an instant and significant increasing in relative humidity. Sensor (WBU30022) is earlier measured an increasing in humidity, implying a wetting of the buffer close to the canister lid.

An increased wetting of the bentonite can be observed by sensors placed in block R10 between the canister and the rock. One sensor placed in block R5 showed an increase in relative humidity from about 70 % to 82 % after the closing of the drainage.

Two sensors (WBU30019 and WBU30020) placed in block R5 measured a decrease in relative humidity (indicating a drying of the buffer) after the power was switched on again. During this measuring period the still working sensors (WBU30020, WBU30033) are measuring a slowly increase in relative humidity. All sensors are out of order.

### **Rotronic (Appendix 2\pages 62-63)**

All Rotronic sensors in hole 3 have failed or increased the measured RH to 100 %. The reason for this is unclear. Since there are no other signs of strong wetting, malfunction is more probable than strong wetting. One sensor (WBU30016) placed close to the canister in block R5 was indicating a drying of the bentonite until it failed.

### **5.3.3 Pore water pressure**

#### **Geocon (Appendix 2\page 64)**

One sensor UBU30009 placed in R5 yields continue increasing to about 0.9 MPa in the end of this measuring period. UBU30014 placed in C4 yielded a maximum pressure of 1.5 MPa (about day 5100).

#### **Kulite (Appendix 2\page 64)**

UBU30006 placed in R5 yields increasing to about 2.3 MPa and stop to work at day 6321.

### **5.3.4 Temperature in the buffer (Appendix 2\pages 65-68)**

The measured temperature ranges from 38 °C (in the periphery of the upper bentonite cylinder C4) to a temperature of 83.2 °C in the centre close to the canister. These measurements are from the period just before the power to the canisters were switched off. The highest temperature gradient measured with the sensors is 0.59 °C/cm (block R5). There have appeared some problems with some DataScan units, which explains the noise in some curves. 30 sensors are out of order.

The temperature in the buffer is also measured with the Geocon sensors (from day 1350). The temperature drops in the buffer measured by the Geocon sensors is caused by the reduction in the applied power on the canister (day 4599). (App. 2\page 76)

### **5.3.5 Canister power in dep. hole 3 (Appendix 2\page 69)**

The power of the canister in hole 3 was kept constant at 1800 W from the start 2001-10-11 until 2002-09-17, when the power was decreased with about 20 W. The power has been stepwise decreased according to Table 4-1. During the period between December 6 and December 15 the power of all canisters was switched off. After that period the power was adjusted to about 1710 W. At the beginning of December 2005, 2006, 2007 and January 2009 and 2010 the power was decreased with 30 W. After these reductions the power was about 1560 W until 2013-05-20 (day 4264) when the power has reduced to about 490 W due to electrical heater failure. The power has reduced to about 360 W (day 4615) due to electrical heater failure.

The canister power in dep hole 3 has switched off (day 5133) due all electrical heaters are out of order.

### **5.3.6 Temperature on the canister surface (Appendix 2\pages 70-71)**

The first diagram shows the maximum temperature plotted as a function of time. The maximum measured temperature on the canister surface was about 100 °C just before the power to the canisters was switched off. The temperature recovered, but only to about 93 °C after the power was switched on again and after that a slightly decrease in temperature was measured until the sensor stopped functioning at the end of August 2005. The second diagram shows the distribution of the temperature along the cables. Thermocouple TBU300016 also measure temperature just above canister lid. See also chapter 5.2.6.

## **5.4 Deposition hole 2**

### **5.4.1 Canister power (Appendix 3\page 72)**

The power of the canister in hole 2 was kept constant at 1800 W from the start 2001-09-24 until 2002-09-17, when the power was decreased with about 20 W. Due to additional calculations, the power of the canister was adjusted to 1800 W on June 23, 2003.

After two years (September 2003) the power was decreased with about 40 W to 1740 W. The interruption in the curve between days 409 and 456 is caused by data collection problems. At the beginning of September 2004, the power was decreased with about 30 W to 1710 W. Since permanent damages on the heaters in the canister were observed on December 1, 2004, the power to this canister has been switched off and not been restarted. 9\*

### **5.4.2 Temperature on the canister surface (Appendix 3\pages 73-74)**

See chapter 5.2.6. The maximum measured temperature (by fibre optical) on the canister surface was just before the power was switched off about 96 °C. The reason for the unexpected increase in temperature after 450 days is the difficulties with the measurement of the power (see chapter 5.2.5). The actual power at that time was probably higher than 1800 W. After the power was switched off the temperature on the canister surface was stabilized on about 30 °C. The sensor stopped giving reliable data at the beginning of June 2005.

## **5.5 Deposition hole 4**

### **5.5.1 Canister power (Appendix 3\page 75)**

The power of the canister in hole 4 was kept constant at 1800 W from the start 2001-10-11 until 2002-09-17, when the power was decreased with about 20 W. Some initial problems with the control system for the power have been overcome. The power has been stepwise decreased according to Table 5-1. During the period between December 6 and December 15 the power of all canisters was switched off. After that period the power was adjusted to about 1710 W. At the beginning of December 2005, 2006, 2007 and January 2009 and 2010 the power was decreased with 30 W.

The power of canister was switched off (day 5497 and 5498) due to heater electric failure. After reduction the power has been about 300 W. During 2018 (day 6239) the power has increased to about 570 W.

### **5.5.2 Temperature on the canister surface (Appendix 3\pages 75-76)**

See chapter 5.2.6. The maximum measured temperature on the canister surface after the power was switched on again was 88 °C. The sensor stopped giving reliable data at the beginning of April 2005.

## **5.6 Backfill in Section1**

### **5.6.1 Total pressure in the backfill**

#### **Geocon (Appendix 4\pages 77)**

All these sensors yielded high increase in total pressure in connection with closing of the tunnel drainage. The maximum measured pressure was about 2.5 MPa at day 1147. After the opening of the drainage the total pressure was stabilized on the same level as before the closing of the drainage (maximum pressure about 0.2 MPa). At around the 20<sup>th</sup> of April 2006, a packer placed in a borehole in Section I of the tunnel started to leak resulting in an increase of water drained out from the inner section from about 1.5 l/min to about 9 l/min. The damaged packer also caused an increase in the measured total pressure of about 300 kPa (around day 1660). At the beginning of April 2007 some of the sensors indicated an increase in the measured pressure. The change in the measure pressures was probably related to the work with the excavation of a new tunnel near by the Prototype-tunnel which was initialized at that time. The measured total pressures at the end of this measuring period vary between 1.6–2.5 MPa at the end of this measuring period. The rapidly increase of pressure around day 4600 caused probably by a damaged packer. Two sensors are out of order.

### **Kulite (Appendix 4 \pages 78)**

These measurements yielded rather small increase in total pressure until the drainage of the tunnel was closed. The maximum pressure recorded is with PBA10013, about 0.35 MPa. The sensor stopped functioning during a period of about 100 days after the rapid increase in pressure when the tunnel drainage was closed. Sensor PBA10013 is placed 1.7 m above the bentonite surface in hole 3. All sensors are out of order.

### **5.6.2 Suction in the backfill (Appendix 4\pages 79-82)**

The suction in the backfill is measured with Wescor psychrometers. The steady but slow wetting (decrease in suction) observed in all the sensors up to day 2330.

7 sensors close to the roof and walls of the tunnel and one sensor just above the buffer in hole 1 indicate fast wetting that has gone close to water saturation (less than 1000 kPa suction). Also, the sensor placed just inside the plug has reached a suction value that indicates saturation. In connection with the closing of the drainage, a very rapid decrease in suction was recorded by the installed psychrometers. Six of these sensors placed in the central part of the tunnel section yielded an increase in suction, after the reopening of the drainage, to the same level as before the closing. Seven of the sensors measured a decrease in suction after the packer was damaged.

All of these sensors have stopped giving reliable values due to high water saturation of the backfill.

### **5.6.3 Pore water pressure in the backfill**

#### **Geocon (Appendix 4\pages 82-83)**

All these sensors yielded high increase in pore pressure when the drainage of the tunnel was closed. Many of the sensors recorded pressures up to 2.5 MPa. After the opening of the drainage the pore pressure was stabilized at low pressures (below 0.1 MPa). Also, these sensors reacted when the packer was broken by measuring an increase in pore pressure of about 0.2 MPa. At the beginning of April 2007 some of the sensors are indicating an increase in the measured pressure. The change in the measure pressures is probably related to the work with the excavation of a new tunnel near by the Prototype-tunnel which was initialized at that time. The measured pore pressures vary between 1.6–1.8 MPa at the end of this measuring period. The rapidly increase of pressure around day 4600 caused probably by a damaged packer.

#### **Kulite (Appendix 4\pages 83-84)**

Also, some of these sensors recorded rapidly an increase of water pressure after the closing of the drainage (day 1110).

The still functioning sensors measured an increase in pore pressure of about 0.2 MPa to 0.3 MPa at 2006-04-20 (day 1674) when a packer from borehole in tunnel leaked.

The sensors reacted also when the excavation of the nearby tunnel was initialized. Two still functioning sensors UBA10005 and UBA10007 have recorded suddenly increasing to about 2.5 MPa at day 4836. The rapidly increase of pressure in the end of this measuring period caused probably by a damaged packer. Eleven sensors are out of order.

### **5.6.4 Temperature in the backfill (Appendix 4\pages 84-86)**

The measured temperature in the backfill over the whole test period ranges from 16 to 35 °C. The highest temperature was as expected (water inflow in the hole3 is lowest) measured above the buffer in hole 3 just before the drainage was opened. Also, these sensors reacted when the packer was broken (a decrease in temperature). The measured temperatures at the end of this measuring period vary between 16 and 17 °C.

## **5.7 Temperature in the rock**

### **5.7.1 Near hole 1 (Appendix 1\pages 54–55)**

The maximum temperature measured in the rock is 38.6 °C. This temperature was measured with the thermocouple TROA1030 located 2.038 m from the centre of the canister in deposition hole1, see table 4.9 .

The temperature in the rock close to the deposition hole decreased when the power to the canisters was switched off but increased again when the power was switched on to a temperature about 1 °C lower than before the power was switched off. The temperature is continuing to drop and the maximum temperature at the end of year 2021 is about 17 °C. The temperature decreasing in the rock caused by problem with applied power in the canister.

#### **5.7.2 Near hole 2 (Appendix 3\page 72)**

The maximum temperature in the rock (46.8 °C) was measured by TROA1820 located 2.490 m from the centre of the canister in deposition hole 2 just before the power to the canisters was switched off. Since no power is applied to this canister anymore the temperature in the rock around the deposition hole is continuing to decrease and the maximum temperature at the end of year 2021 is about 18 °C. The temperature decreasing in the rock caused by problem with applied power in the canister.

#### **5.7.3 Near hole 3 (Appendix 2\pages 68–69)**

The maximum temperature in the rock (48.8 °C) was measured by TROA2120 located 1.967 m from the centre of the canister in deposition hole 3 just before the power to the canisters was switched off. Although the power was switched on again the temperature around the deposition hole is continuing to drop. This is most obvious for the sensors installed in the direction towards deposition hole 2. The maximum temperature measured temperature at the end of this measuring period is about 18 °C. The temperature decreasing in the rock caused by problem with applied power in the canister.

#### **5.7.4 Near hole 4 (Appendix 3\page 74)**

The maximum temperature in the rock (46.5 °C) is measured by TROA3030 located 2.034 m from the centre of the canister in deposition hole 4.

Also, for this deposition hole there was a drop in the temperature in the rock when the power was switched off. After the power was switched on again the temperature in the rock increased to almost the same level as before the power was switched off and has been remained relatively constant until last measuring period (day 4264) after reduction of power in the canister in hole3. The maximum temperature in the rock at the end of this measuring period is about 20 °C. The temperature decreasing in the rock caused by problem with applied power in the canister.

## References

SKB's (Svensk Kärnbränslehantering AB) publications can be found at [www.skb.com/publications](http://www.skb.com/publications).

**Collin M, Börgesson L, 2001.** Äspö Hard Rock Laboratory. Prototype Repository. Instrumentation in buffer and backfill for measuring of THM processes. SKB IPR-02-03, Svensk Kärnbränslehantering AB.

**Börgesson L, Sandén T, 2001.** Äspö Hard Rock Laboratory. Prototype Repository. Report on instrument positions in buffer/backfill and preparation of bentonite blocks for instruments and cables in section I. SKB IPR-01-20, Svensk Kärnbränslehantering AB.

**Forsmark T, Rhén I, Andersson C, 2001.** Äspö Hard Rock Laboratory. Prototype Repository. Hydrogeology – Injection test campaign 2, Flow measurement of DA3575G01, groundwater salinity, ground water leakage into G-, I- and J-tunnels. SKB IPR-01-31, Svensk Kärnbränslehantering AB.

**Goudarzi R, 2014.** Prototype Repository – Sensor data report (Period 010917–130101). Report No 24. SKB P-13-39, Svensk Kärnbränslehantering AB.

**Goudarzi R, 2022.** Prototype Repository – Sensor data report (Period 010917–210101). Report No 32. SKB P-21-28, Svensk Kärnbränslehantering AB.

**Rhén I, Forsmark T, 2001.** Äspö Hard Rock Laboratory. Prototype Repository. Hydrogeology. Summary report of investigations before the operation phase. SKB IPR-01-65, Svensk Kärnbränslehantering AB.

**Rhén I, Forsmark T, Magnusson J, Alm P, 2003.** Äspö HRL – Prototype repository. Hydrogeological, hydro chemical, hydro mechanical and temperature measurements in boreholes during the operation phase of the prototype repository. Tunnel section II. SKB IPR-03-22, Svensk Kärnbränslehantering AB.

**Svemar C, Pusch R, 2000.** Äspö Hard Rock Laboratory. Prototype Repository. Project description. FIKW-CT-2000-00055. SKB IPR-00-30, Svensk Kärnbränslehantering AB.

# Appendix 1

## Dep. hole 1

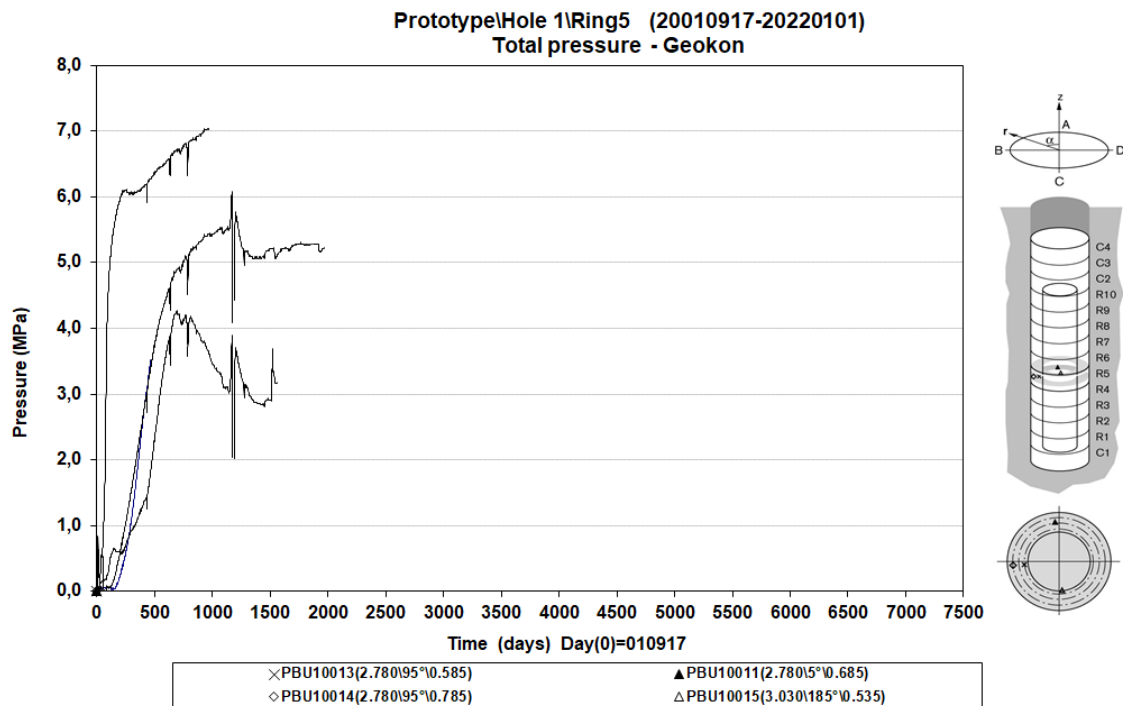
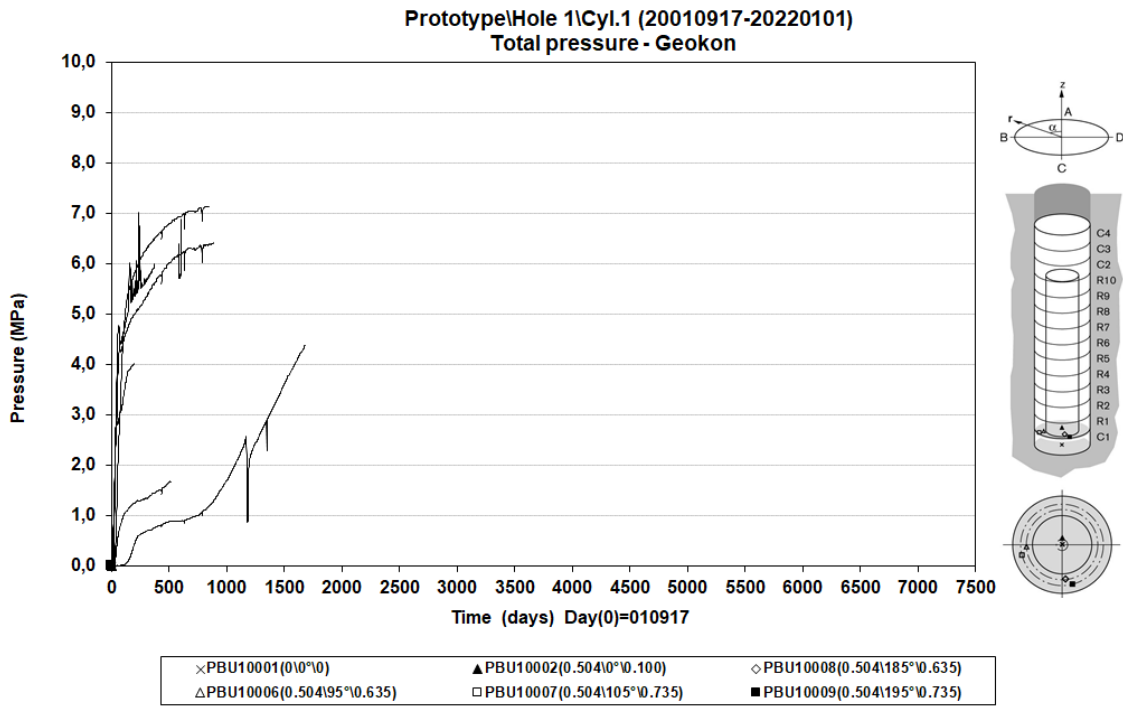



Prototype\Hole 1\ Ring10 and Cyl.3 (20010917-20220101)  
Total pressure - Geokon

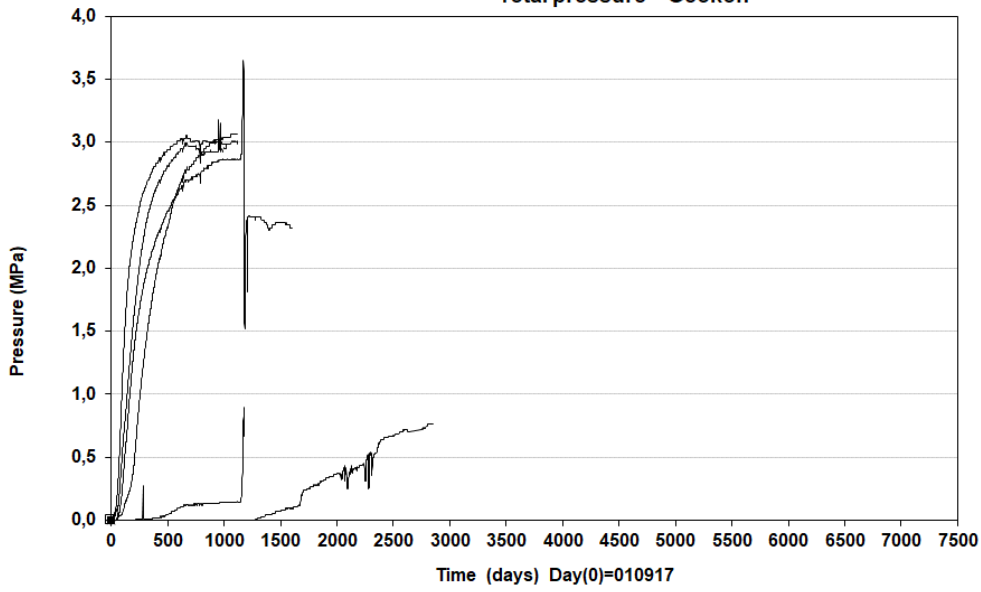

× PBU10017(5.558\0°\0.050)	▲ PBU10021(5.558\90°\0.635)	◇ PBU10022(5.558\100°\0.735)
△ PBU10023(5.558\190°\0.735)	□ PBU10026(6.567\5°\0.585)	■ PBU10024(5.558\180°\0.635)

Prototype\ Hole 1 (20010917-20220101)  
Total pressure - Kulite

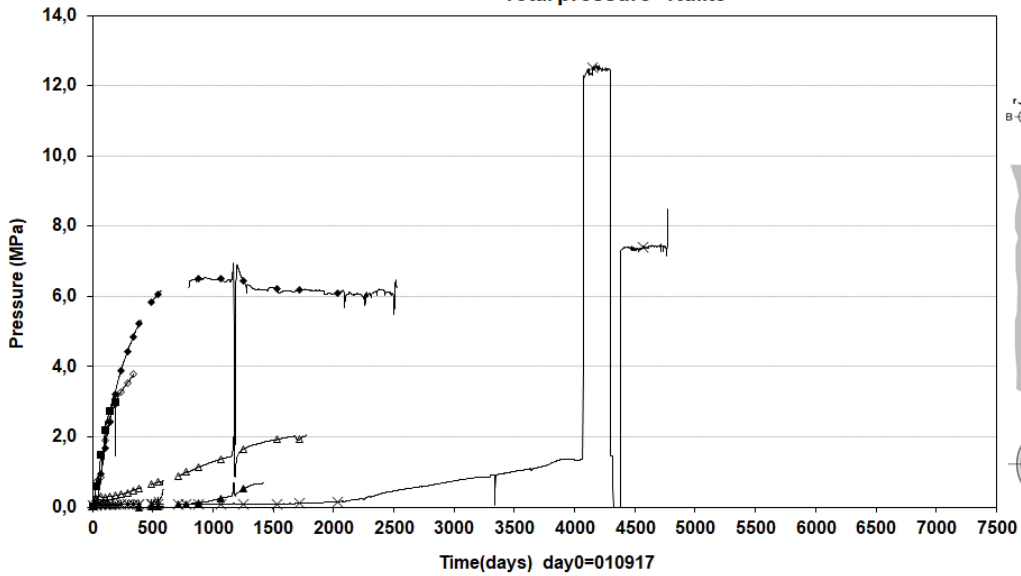

■ PBU10004(0.504\5°\0.685)	◇ PBU10005(0.504\5°\0.785)	◆ PBU10012(3.030\5°\0.785)	▲ PBU10019(5.558\5°\0.685)
△ PBU10020(5.558\5°\0.785)	× PBU10025(6.317\0°\0.050)	* PBU10027(7.076\0°\0.050)	

Prototype\Hole 1\Cyl.1 (20010917-20220101)  
Relative humidity - Vaisala

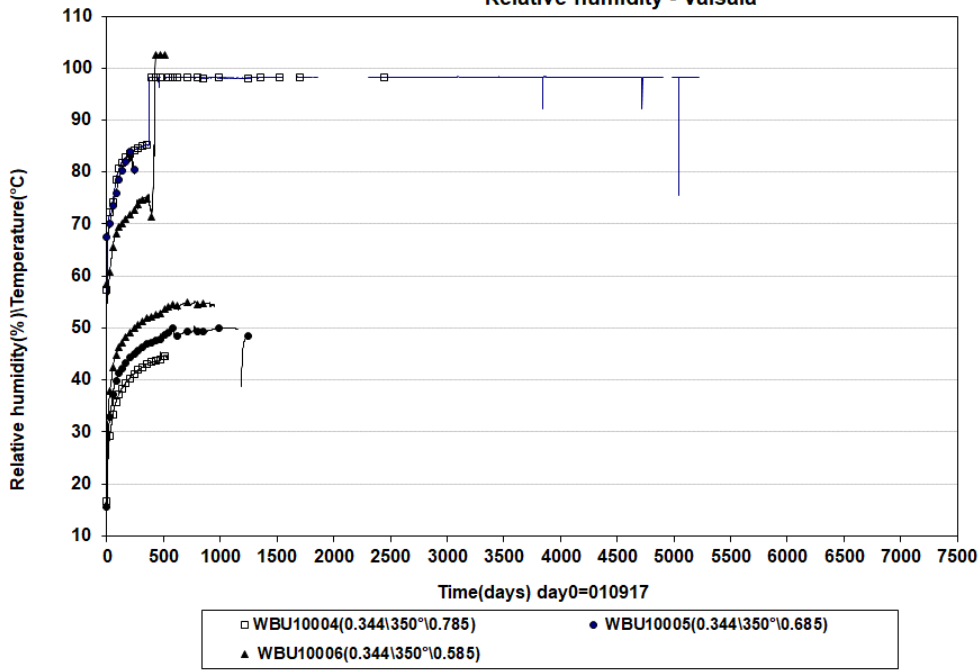

Prototype\Hole 1\Ring.5 (20010917-20220101)  
Relative humidity - Vaisala

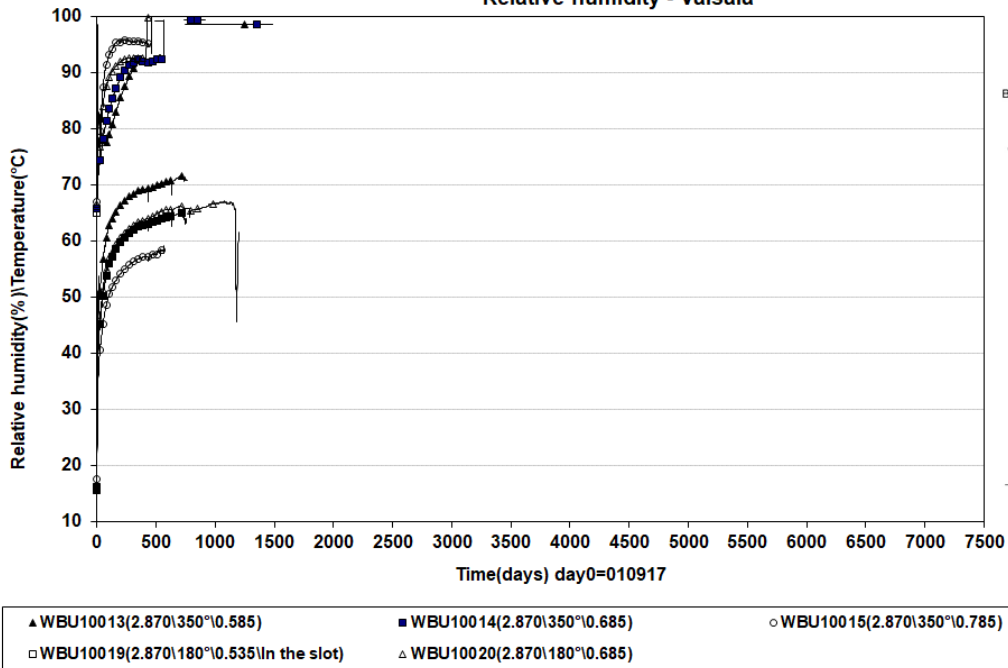

Prototype\Hole 1\Ring10 (20010917-20220101)  
Relative humidity - Vaisala

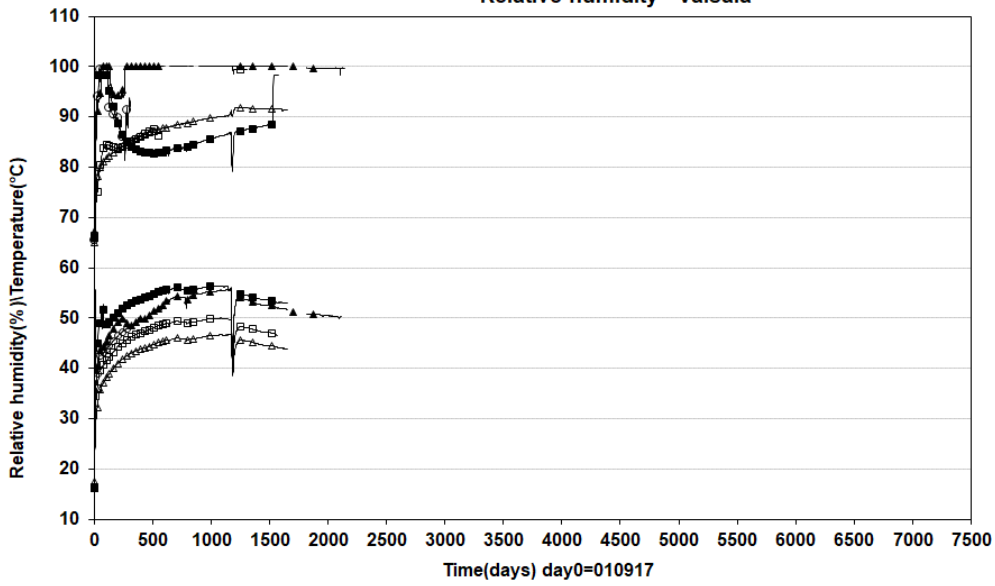

■ WBU10023(5.428\180°\0.362)	○ WBU10024(5.398\350°\0.585)	□ WBU10025(5.398\350°\0.685)
△ WBU10026(5.398\350°\0.785)	▲ WBU10030(5.398\170°\0.585)	

Prototype\Hole 1\Cyl.3 and Cyl.4 (20010917-20220101)  
Relative humidity - Vaisala

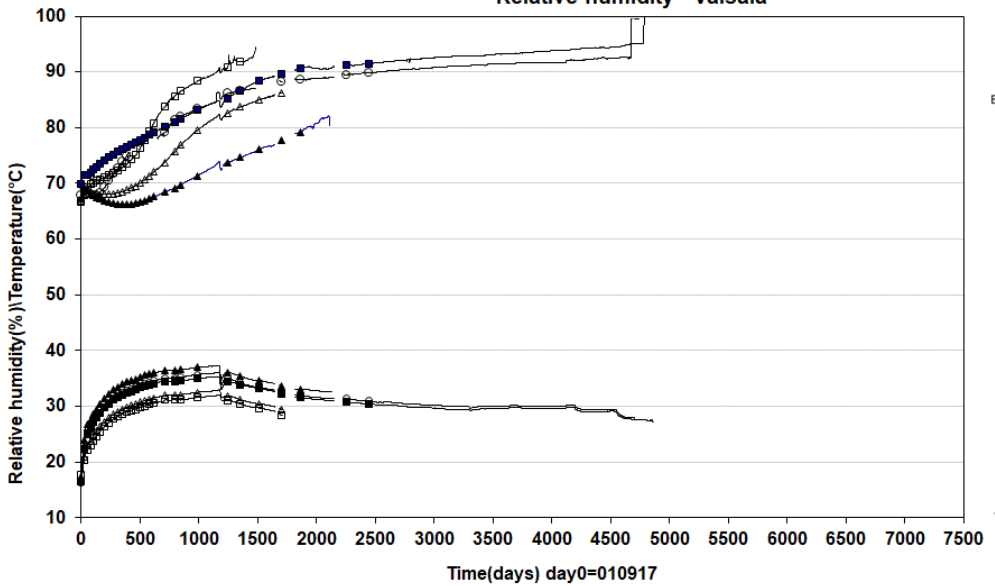

▲ WBU10032(6.317\270°\0.050)	■ WBU10033(6.317\350°\0.585)	○ WBU10034(6.317\90°\0.585)
□ WBU10036(6.916\180°\0.050)	△ WBU10037(6.756\270°\0.050)	

Prototyp\Hole 1\Cyl.1 (20010917-20220101)  
Relative humidity - Rotronic

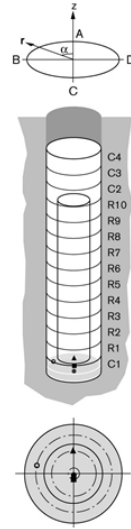
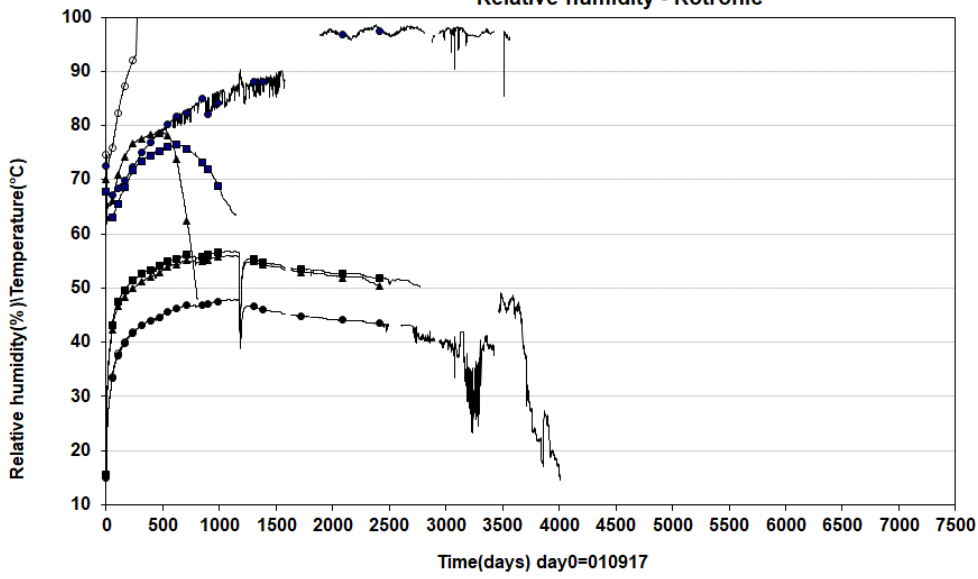

- |                               |                             |
|-------------------------------|-----------------------------|
| ● WBU10001 (0.054\180°\0.050) | ▲ WBU10002 (0.254\0°\0.400) |
| ■ WBU10003 (0.254\180°\0.100) | ○ WBU10008(0.254\80°\0.685) |

Prototyp\Hole 1\Cyl.1 (20010917-20220101)  
Relative humidity - Rotronic

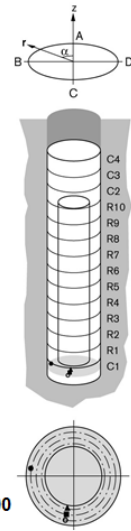
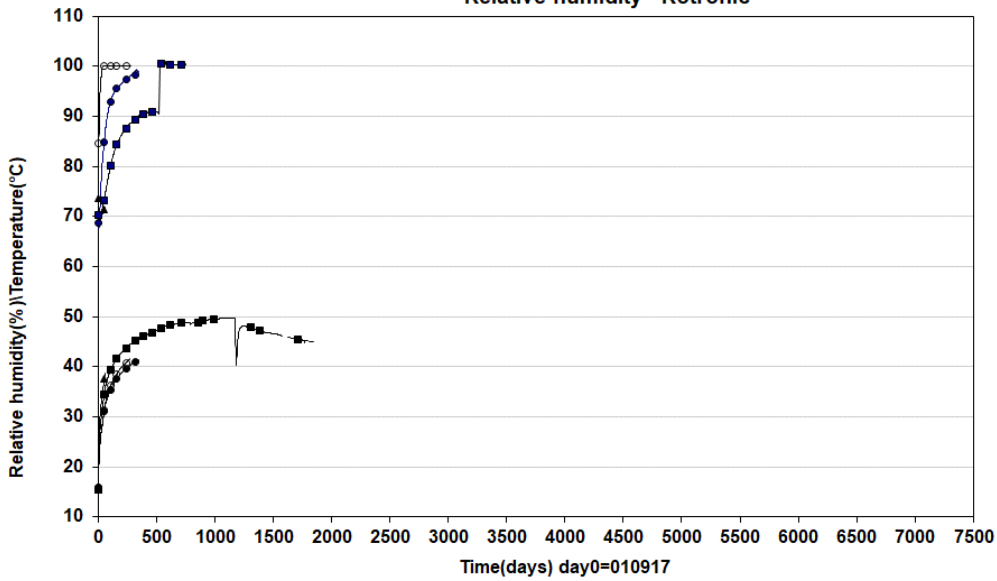

- |                              |                              |
|------------------------------|------------------------------|
| ● WBU10009(0.254\80°\0.785)  | ▲ WBU10010(0.254\170°\0.585) |
| ■ WBU10011(0.254\170°\0.685) | ○ WBU10012(0.254\170°\0.785) |

PrototypHole 1\Ring.5 (20010917-20220101)  
Relative humidity - Rotronic

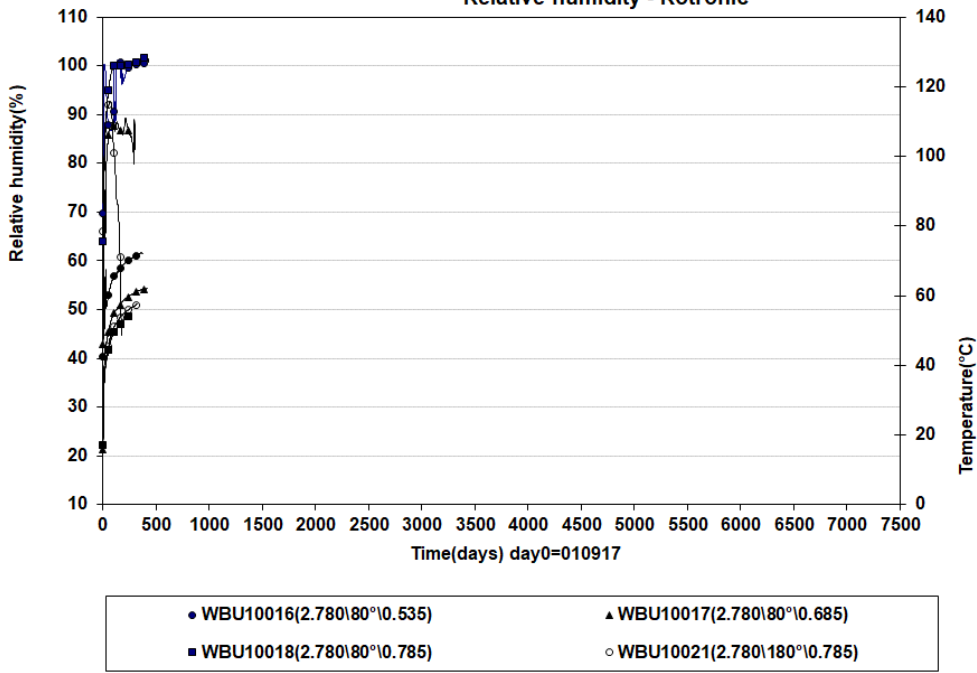

PrototypHole 1\Ring10 (20010917-20220101)  
Relative humidity - Rotronic

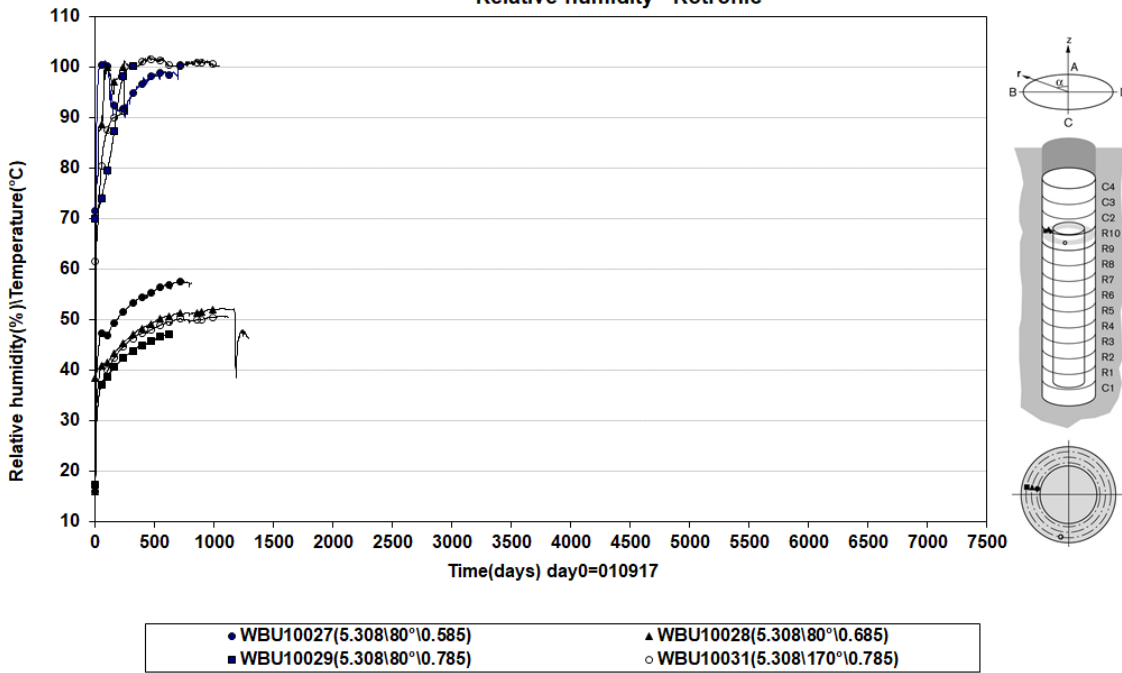

Prototyp\Hole 1\Cyl.3 (20010917-20220101)  
Relative humidity - Rotronic

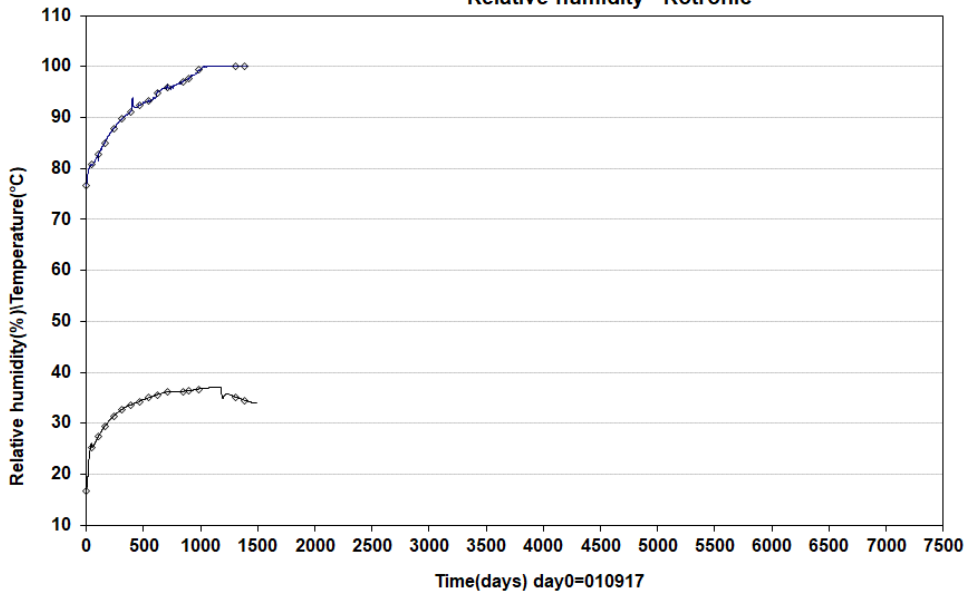

◇ WBU10035(6.317\180°\0.585)

Prototyp\Hole 1 (20010917-20220101)  
Pore pressure - Geokon

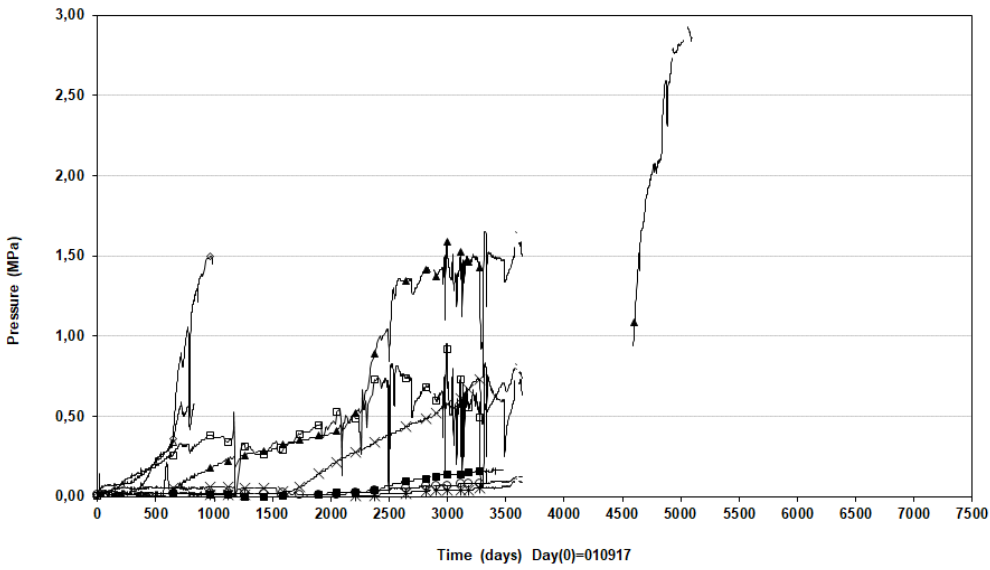

× UBU10002(0.254\90°\0.100)	▲ UBU10003(0.344\355°\0.585)	◇ UBU10005(2.780\355°\0.585)
△ UBU10009(2.780\175°\0.535)	□ UBU10010(2.780\175°\0.825)	■ UBU10012(5.308\355°\0.785)
○ UBU10013(6.317\90°\0.050)	× UBU10014(6.916\90°\0.050)	

Prototype\Hole 1 (010917-20220101)  
Pore pressure - Kulite

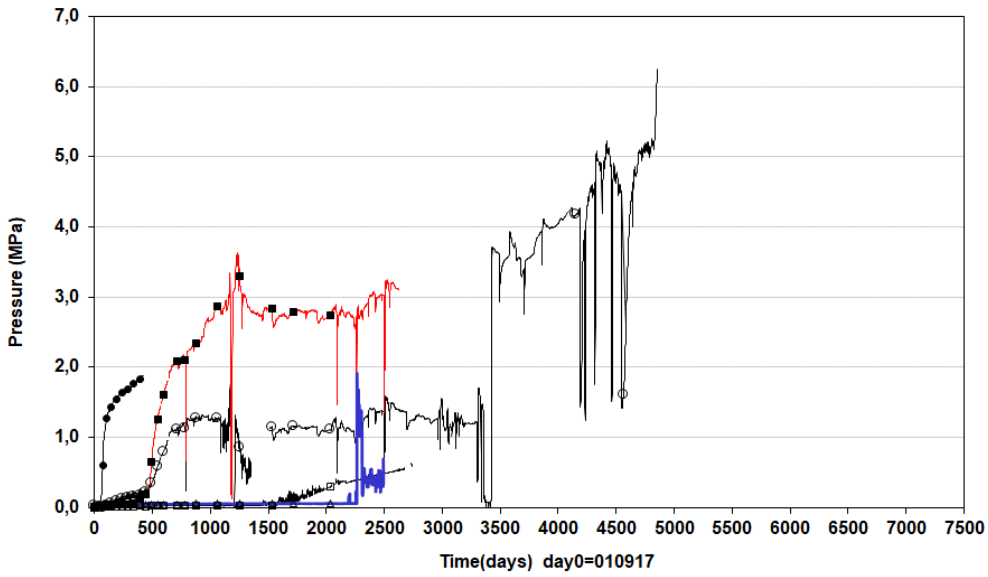

- |                              |  |
|------------------------------|--|
| □ UBU10001(0.054\90°\0.050)  | ▲ UBU10004(0.344\355°\0.785)           |
| ○ UBU10006(2.870\355°\0.785) | ■ UBU10007(2.870\85°\0.535In the slot) |

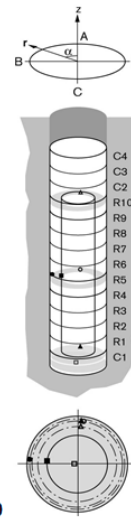

Prototype\Hole 1\Cyl.1 (010917-20220101)  
Temperature - Pentronic

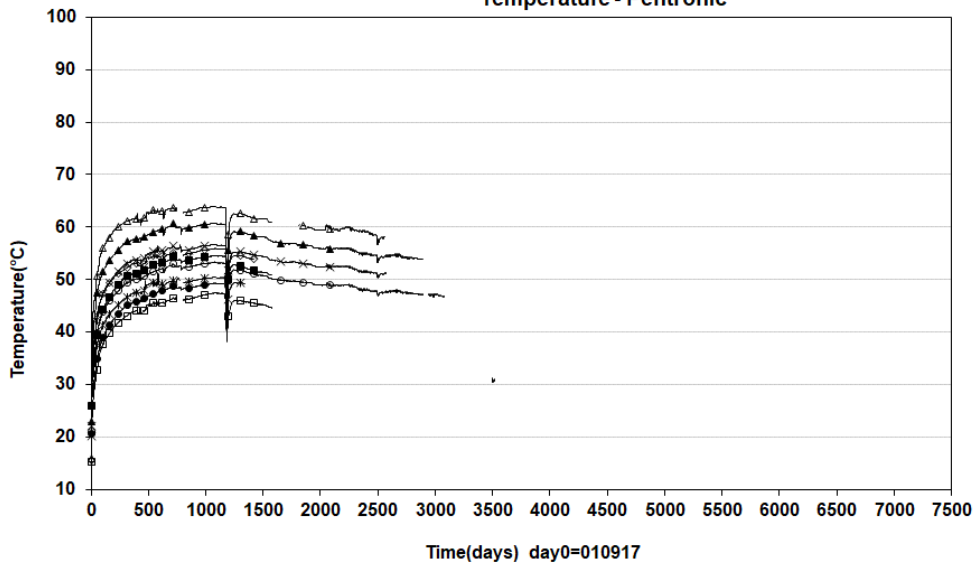

- |                              |                              |                              |
|------------------------------|------------------------------|------------------------------|
| □ TBU10001(0.054\270°\50)    | ◇ TBU10002(0.254\270°\0.050) | △ TBU10003(0.454\270°\0.050) |
| × TBU10004(0.454\355°\0.635) | × TBU10005(0.454\355°\0.735) | ■ TBU10007(0.454\175°\0.685) |
| ▲ TBU10008(0.454\270°\0.585) | ○ TBU10009(0.454\270°\0.685) | ● TBU10010(0.454\270°\0.785) |

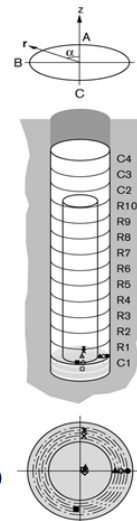

Prototype\Hole 1 \Ring5 (20010917-20220101)  
Temperature - Pentronic

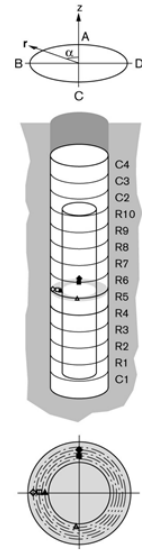
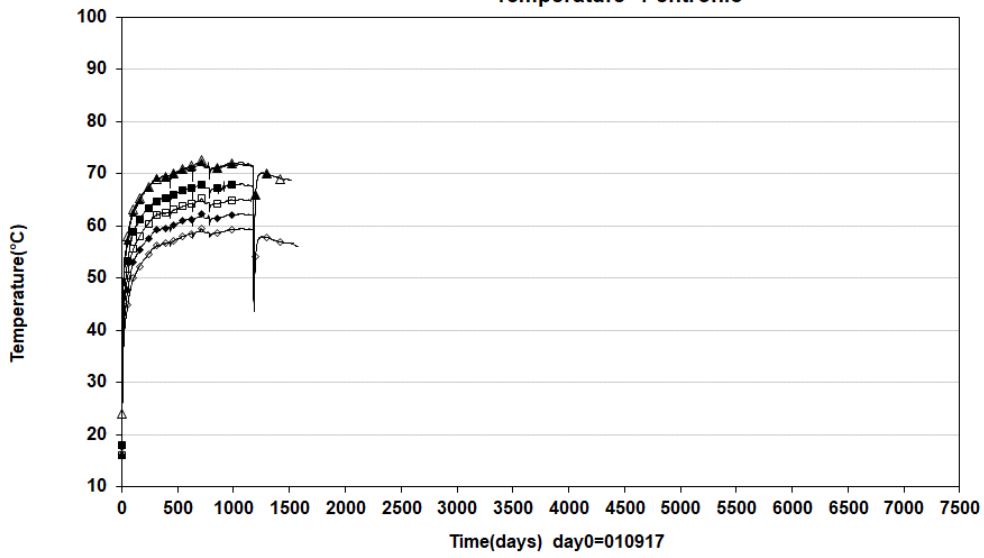

- |                             |                             |                              |
|-----------------------------|-----------------------------|------------------------------|
| ■ TBU10011(2.980\0°\0.635)  | ◆ TBU10012(2.980\0°\0.735)  | ▲ TBU10013(2.980\90°\0.585)  |
| □ TBU10014(2.980\90°\0.685) | ◇ TBU10015(2.980\90°\0.785) | △ TBU10016(2.980\175°\0.585) |

Prototype\Hole 1 \Ring5 (20010917-20220101)  
Temperature - Pentronic

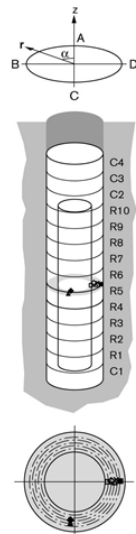
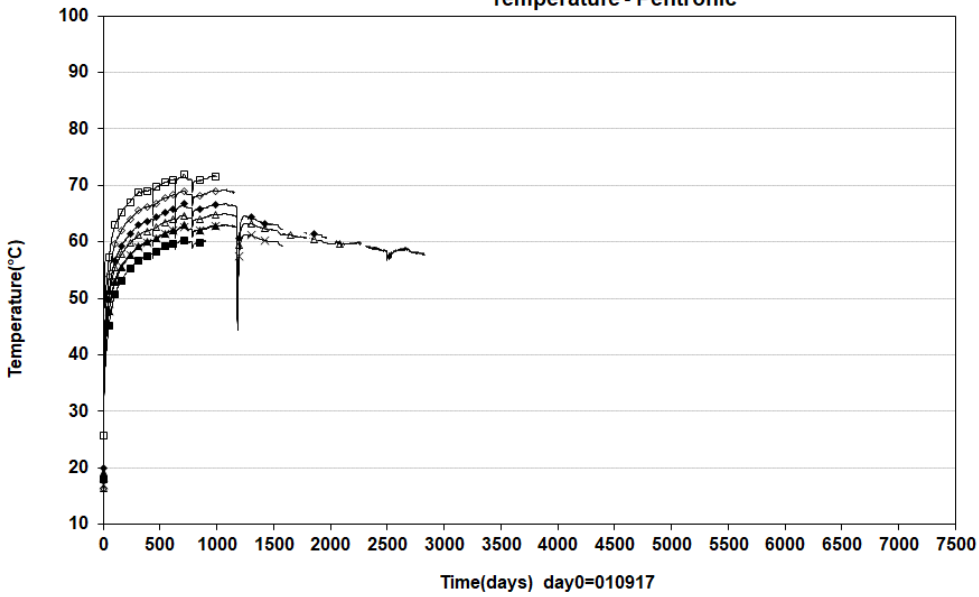

- |                              |                              |                              |
|------------------------------|------------------------------|------------------------------|
| ◆ TBU10017(2.980\175°\0.685) | ▲ TBU10018(2.980\175°\0.735) | □ TBU10019(2.980\270°\0.585) |
| ◇ TBU10020(2.980\270°\0.635) | △ TBU10021(2.980\270°\0.685) | × TBU10022(2.980\270°\0.735) |



Prototype\Hole 1 \Ring10 (20010917-20220101)  
Temperature - Pentronic

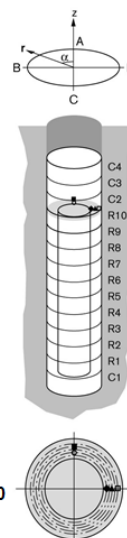
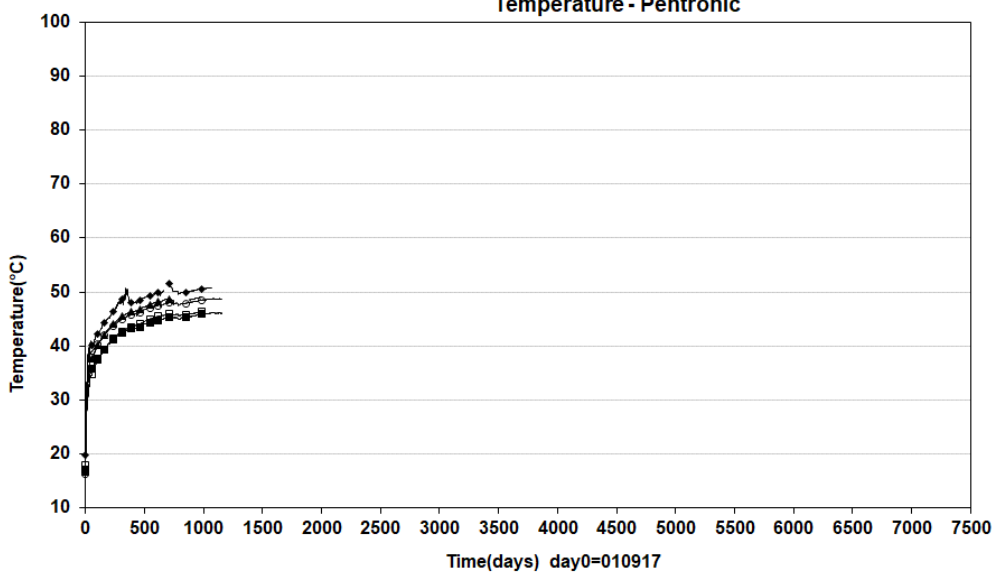

○ TBU10024(5.508\0°\0.635)	■ TBU10025(5.508\0°\0.735)	◆ TBU10026(5.508\270°\585)
▲ TBU10027(5.508\270°\0.685)	□ TBU10028(5.508\270°\0.785)	

Prototype\Hole 1 \Cyl.3 and Cyl.4 (20010917-20220101)  
Temperature - Pentronic

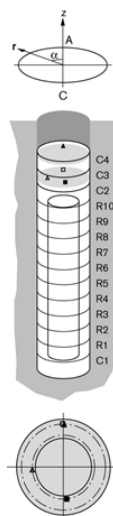
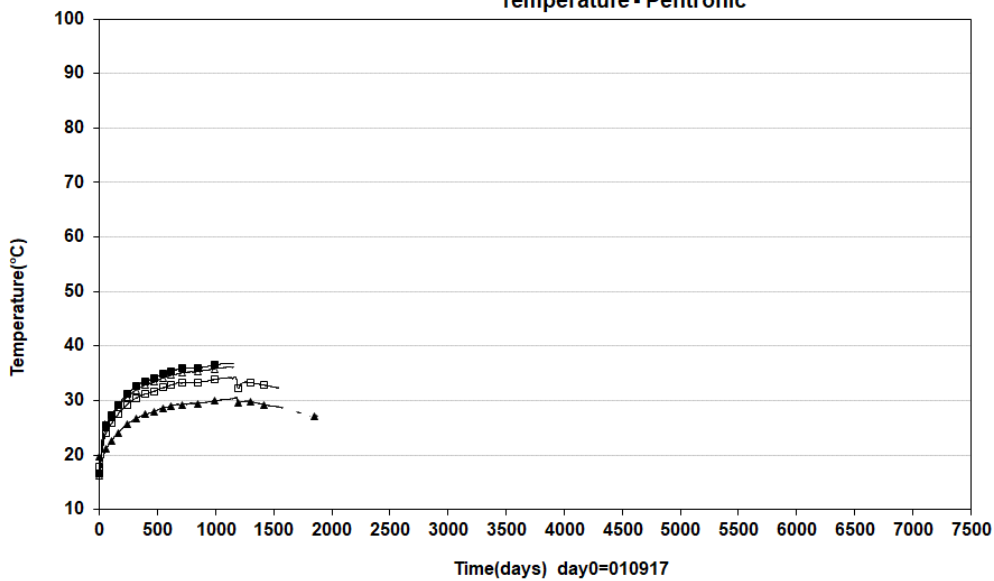

□ TBU10029(6.317\0°\0.785)	△ TBU10030(6.317\95°\0.585)
■ TBU10031(6.317\185°\0.585)	▲ TBU10032(7.026\0°\0.785)

PrototypelHole 1\Cyl.1 (20010917-20220101)  
Temprature - Geokon

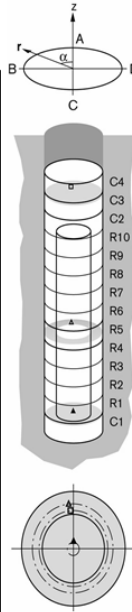
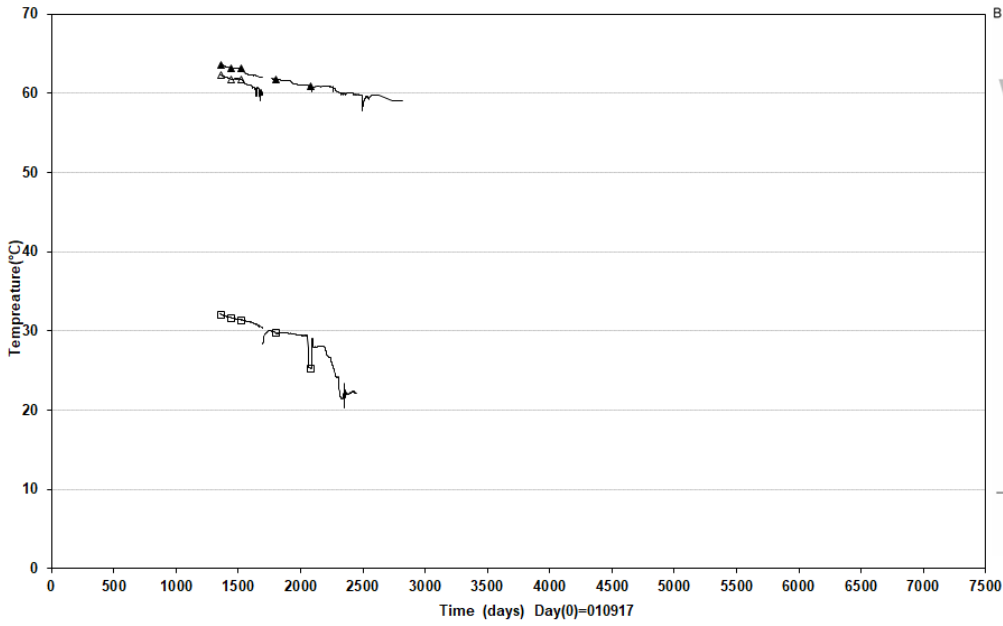

PrototypelHole 1 (20010917-20220101)  
Temprature - Geokon

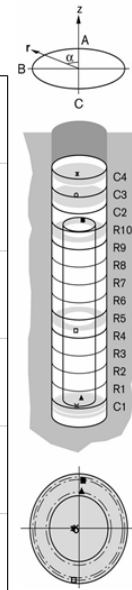
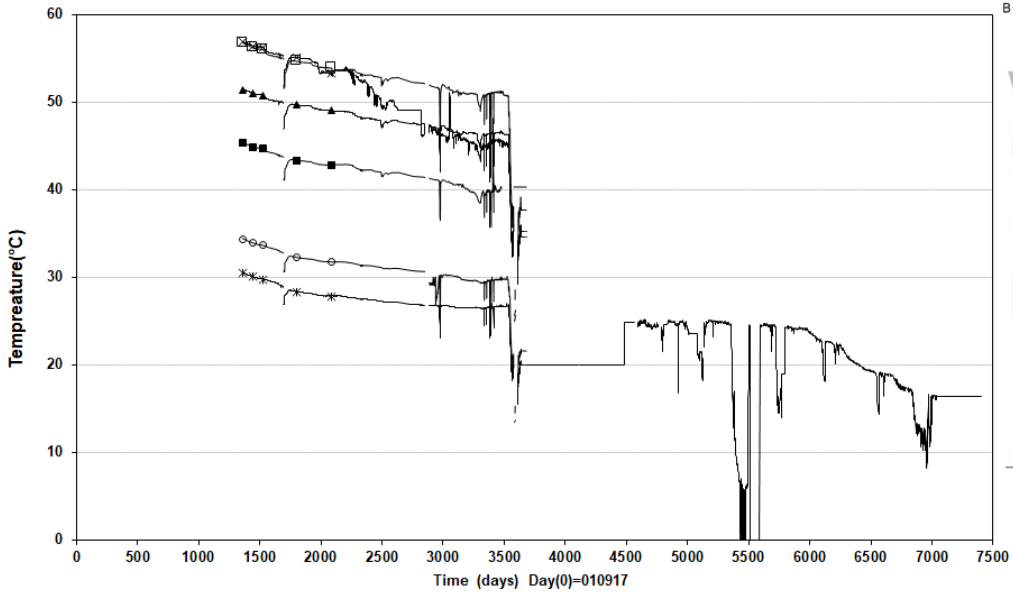

PrototypeRock\Hole 1 (20010917-20220101)  
Temperature - Pentronic

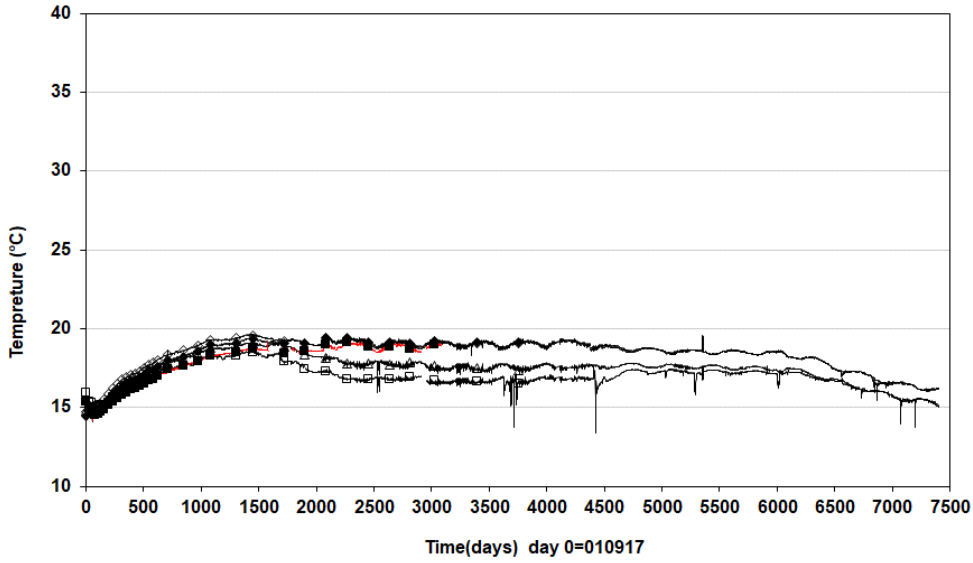

□ TROA350 (7.784\360°\9.086)	△ TROA340 (5.784\360°\9.086)	◇ TROA330(3.3840°\9.086)
◆ TROA320(0.9850°\9.087)	■ TROA310(-1.7150°\9.086)	

PrototypeRock\Hole 1 (20010917-20220101)  
Temperature - Pentronic

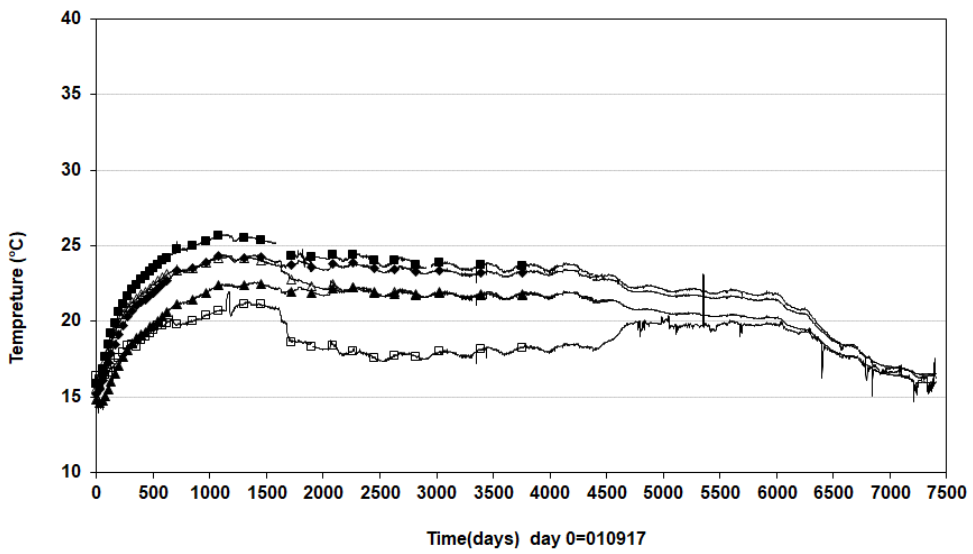

□ TROA650(7.921\360°\4.966)	△ TROA640(5.921\360°\4.988)	■ TROA630(3.521\360°\4.978)
◆ TROA620(1.121\360°\4.968)	▲ TROA610(-1.479\360°\4.956)	

Prototype\Rock\Hole 1 (20010917-20220101)  
Temperature - Pentronic

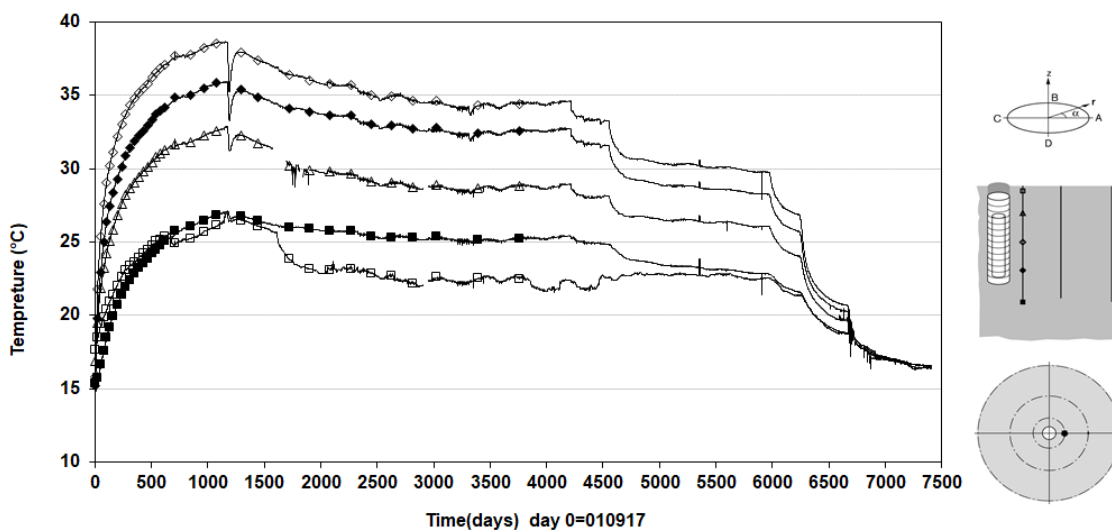

□ TROA1050(7.662\359°\2.020)	△ TROA1040(5.662\359°\2.028)	◇ TROA1030(3.262\359°\2.038)
◆ TROA1020(0.862\359°\2.048)	■ TROA1010(-1.838\359°\2.059)	

Prototype\Hole 1 (20010917-20220101)  
Canister power

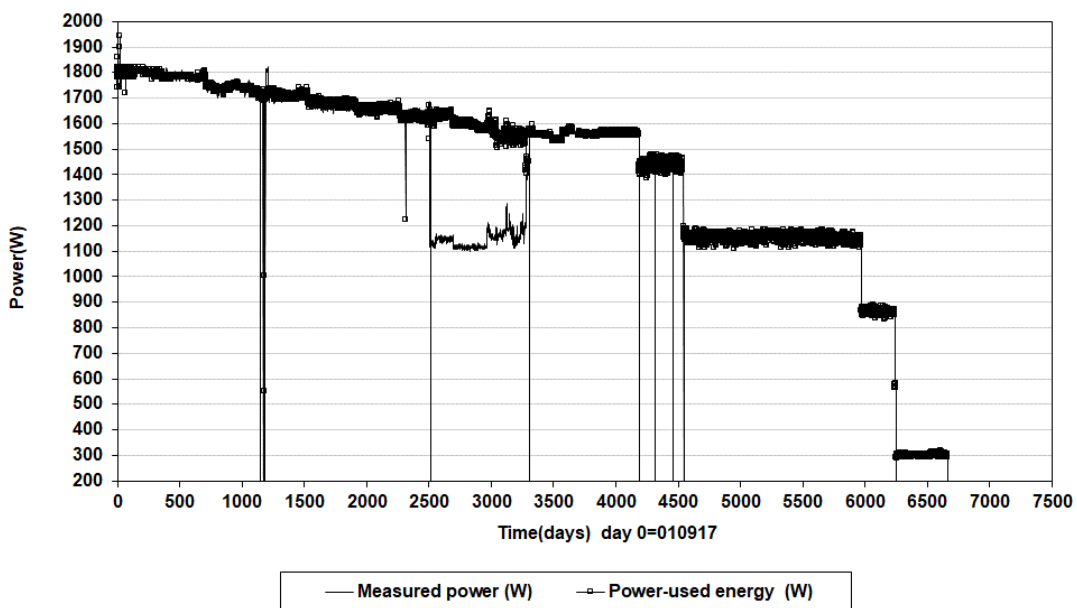

Prototype\ Hole 1 \Canister (010917-070601)  
 Max. temperature on the canister surface - Optical fiber cables

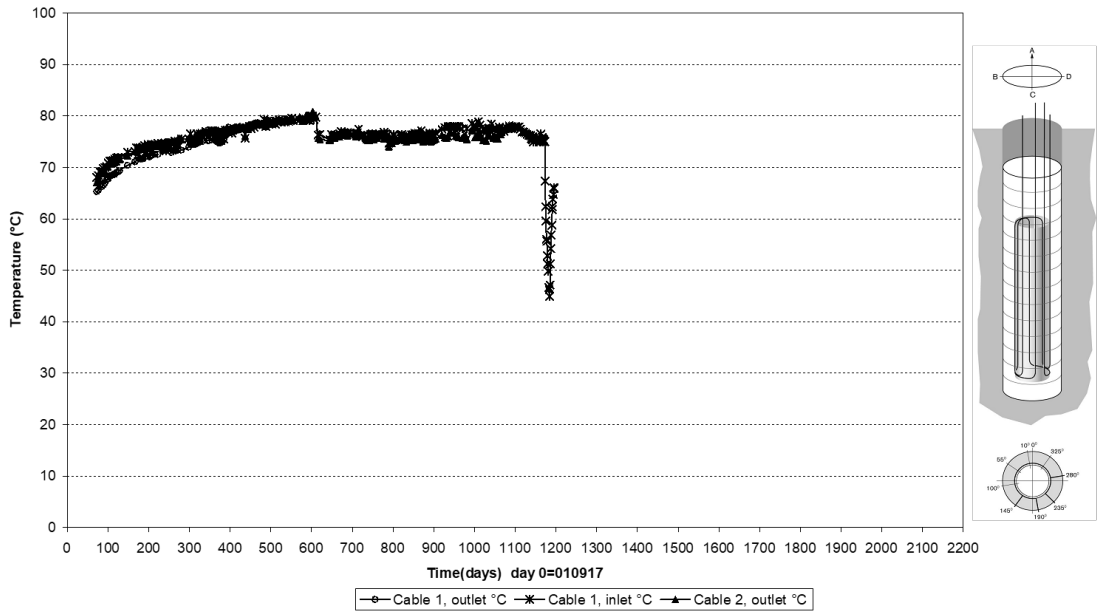

Prototype\ Hole 1 \Canister (041201)  
 Temperature profile on the canister surface - Optical fiber cables

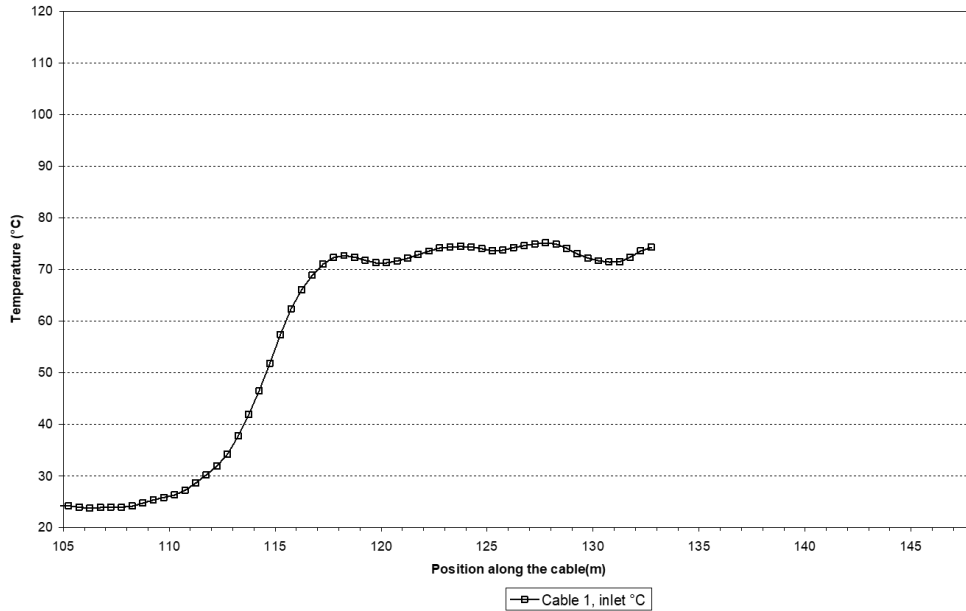

# Appendix 2

## Dep. hole 3

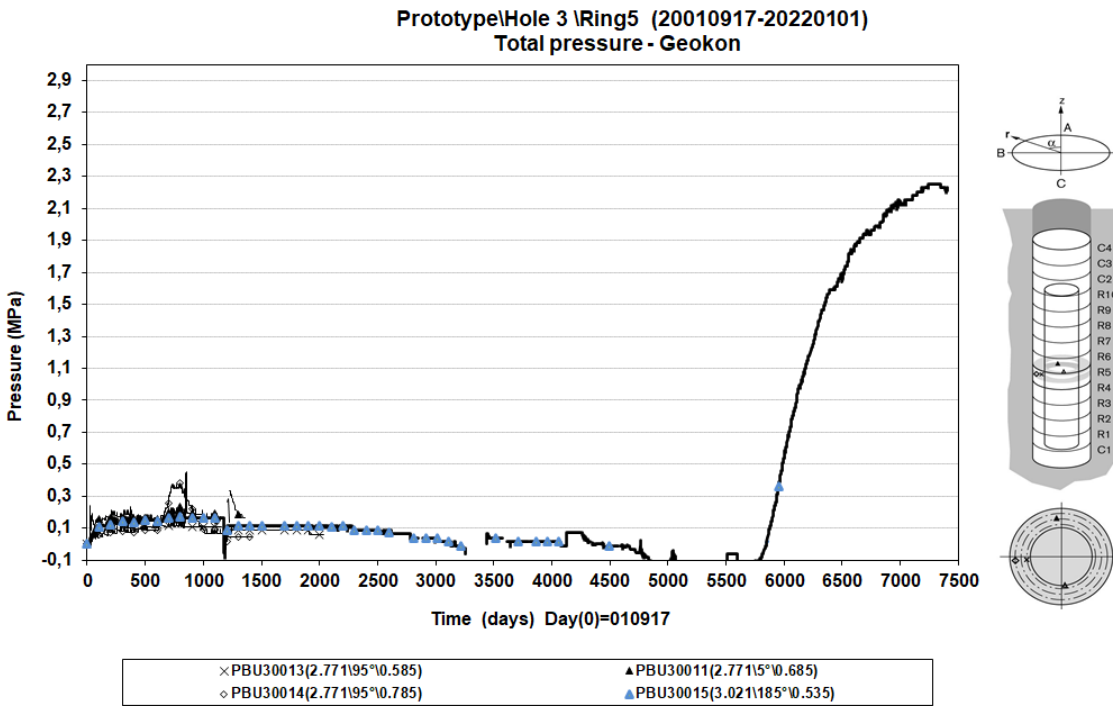
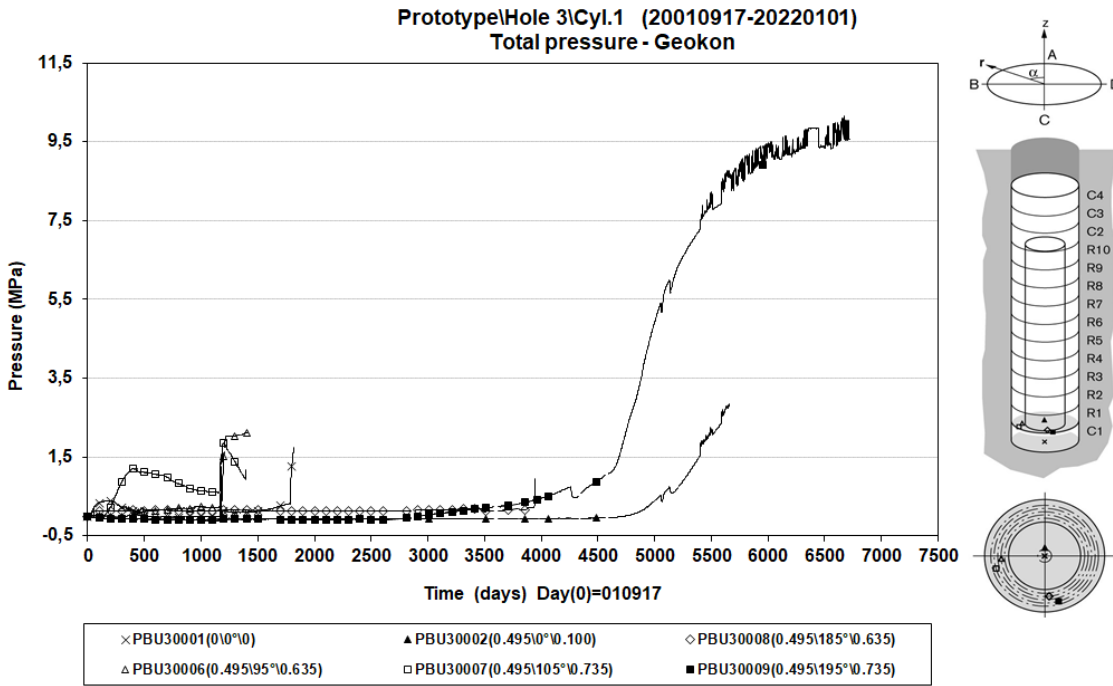

Prototype\Hole 3\Ring10 and Cyl.3 (20010917-20220101)  
Total pressure - Geokon

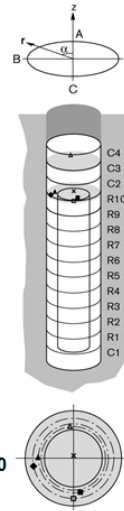
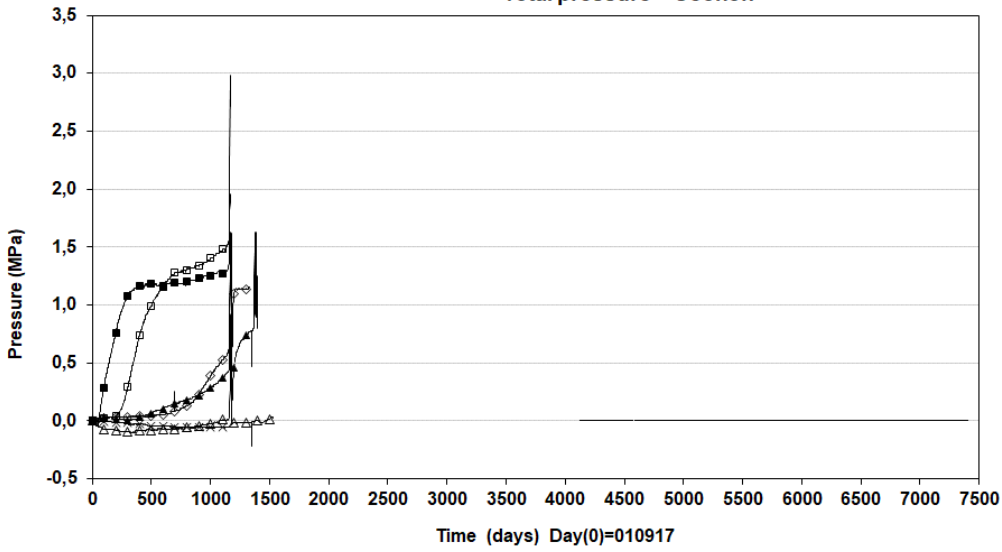

× PBU30017(5.556\0°\0.050)	▲ PBU30021(5.556\90°\0.635)	◇ PBU30022(5.556\100°\0.735)
△ PBU30026(6.654\15°\0.585)	□ PBU30023(5.556\190°\0.735)	■ PBU30024(5.556\190°\0.635)

Prototype\Hole 3\Cyl.1 and Ring5 (20010917-20220101)  
Total pressure - Kulite

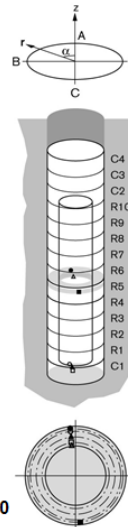
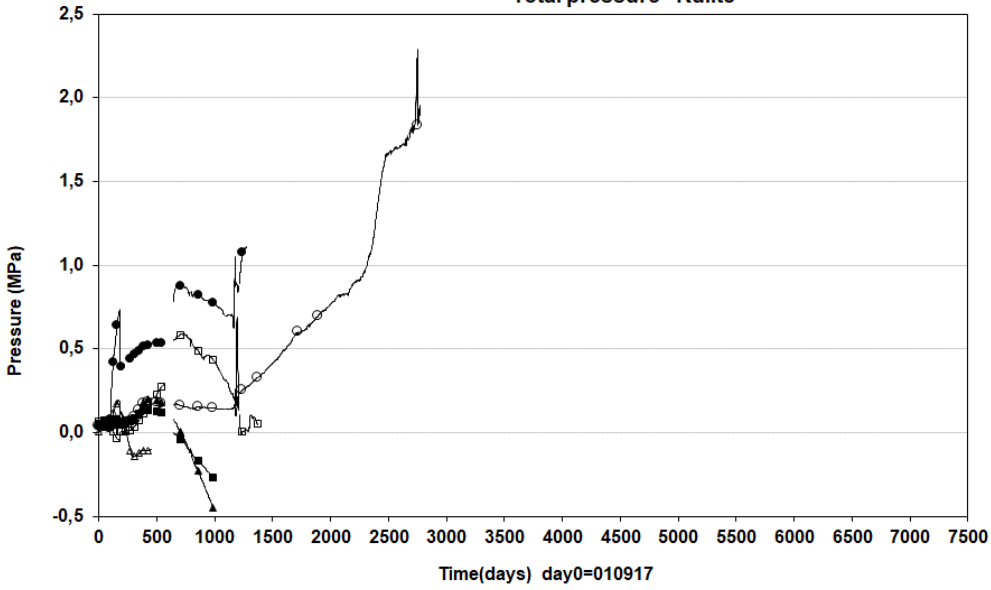

□ PBU30003(Cyl.1\15°\0.585)	▲ PBU30004(Cyl.1\15°\0.685)	○ PBU30005(Cyl.1\15°\0.785)
△ PBU30010(Ring5\15°\0.585)	● PBU30012(Ring5\15°\0.825)	■ PBU30016(Ring5\185°\0.825)

Prototype\Hole 3\Ring10 and Cyl.3-4 (010917-20220101)  
Total pressure - Kulite

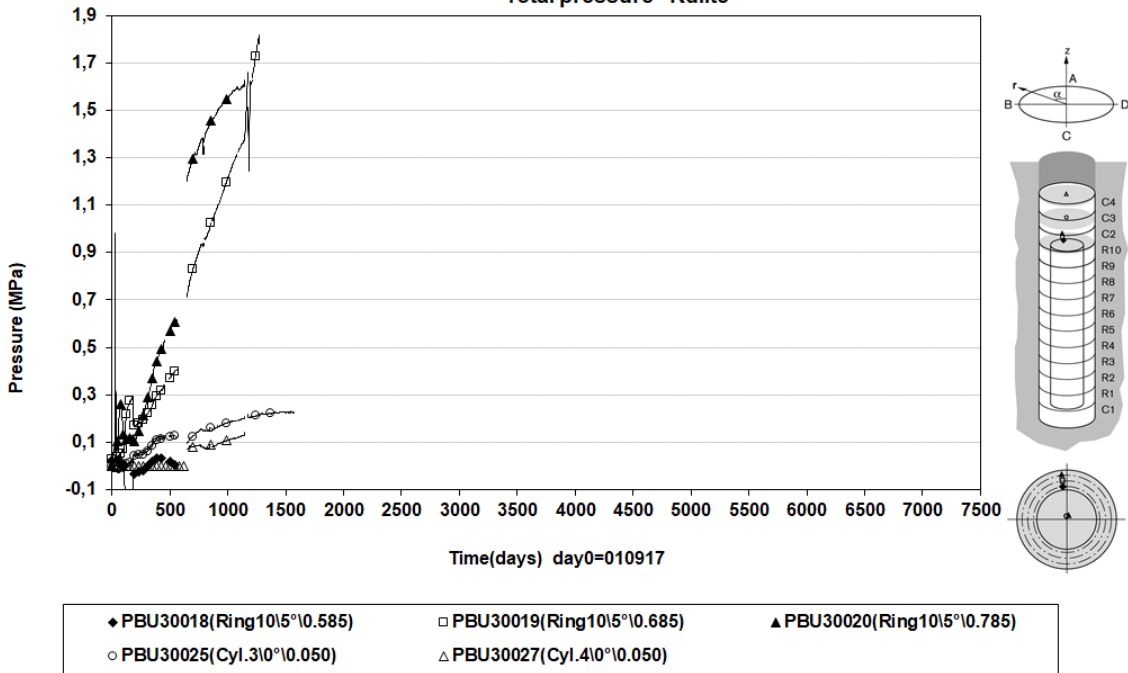

Prototype\Hole 3\Cyl.1 (20010917-20220101)  
Relative humidity - Vaisala

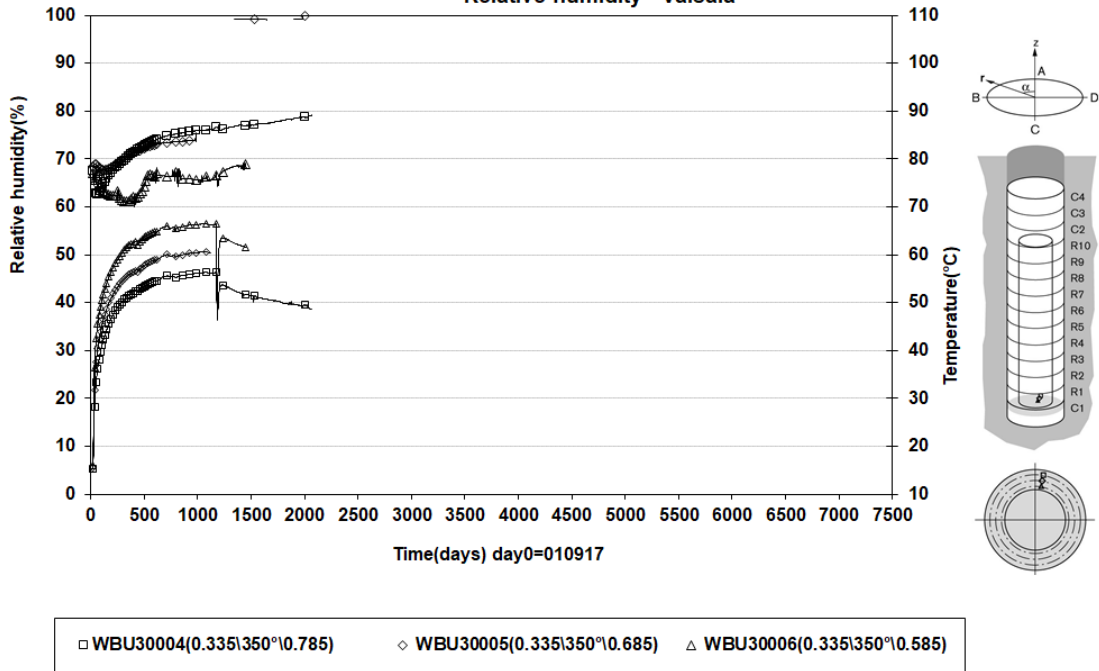



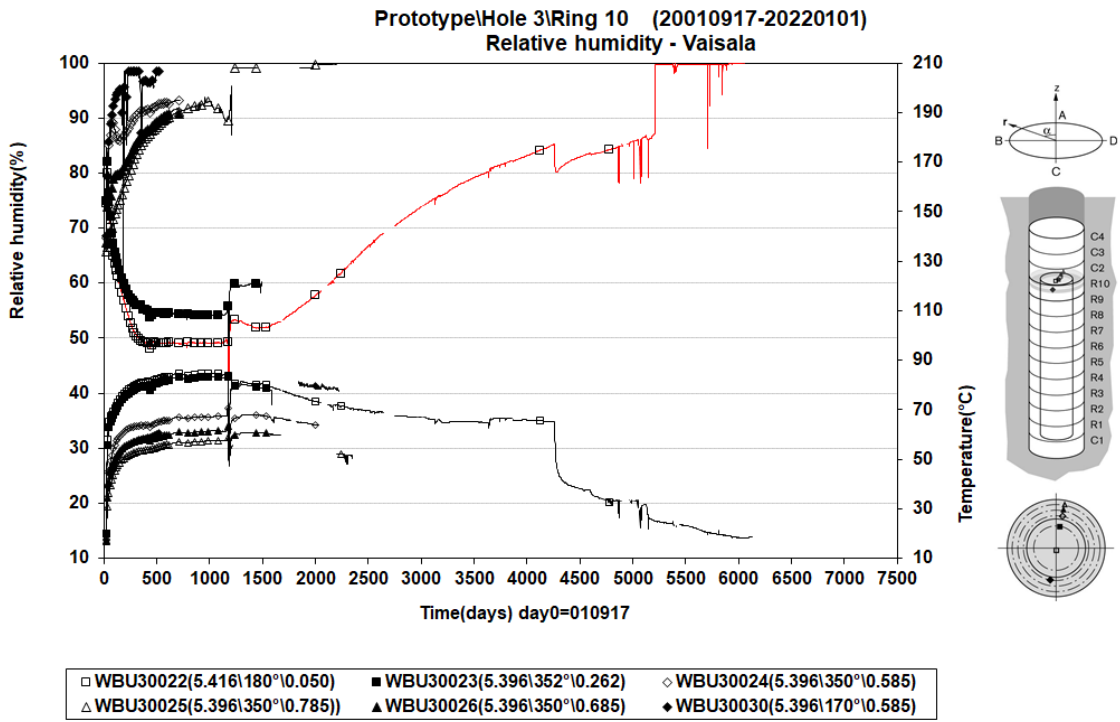
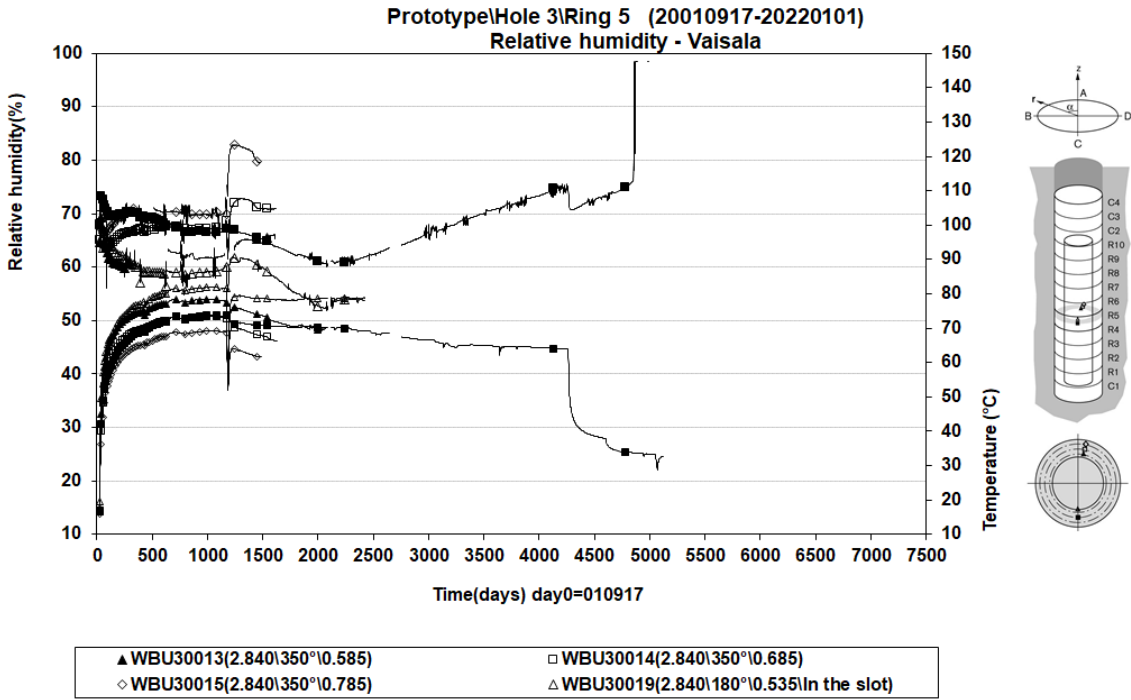

Prototype\Hole 3\Cyl.3 and Cyl.4 (20010917-20220101)  
Relative humidity - Vaisala

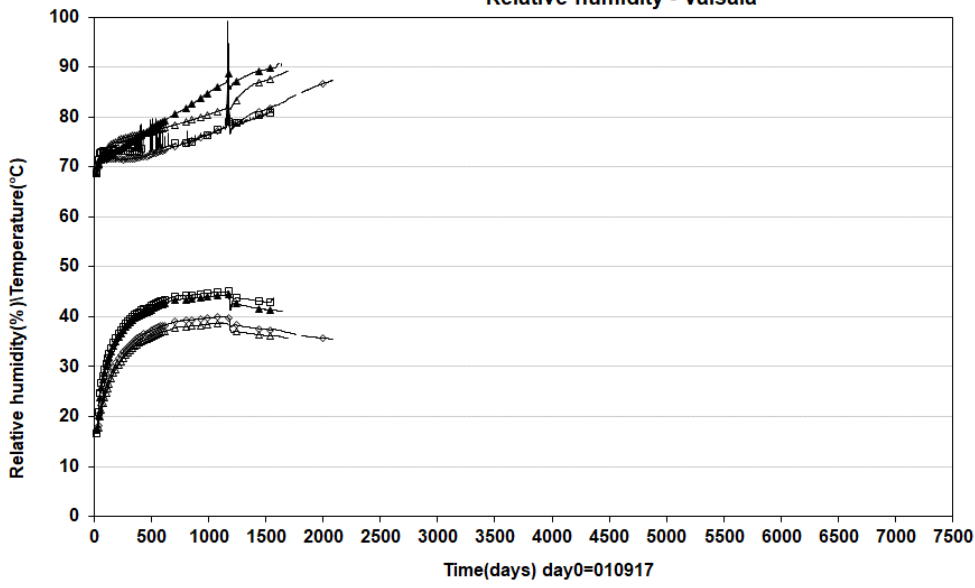

□ WBU30032(6.314\180°\0.050)	▲ WBU30033(6.314\350°\0.585)
△ WBU30036(6.680\180°\0.050)	◇ WBU30037(6.840\270°\0.050)

Prototype\Hole 3\Cyl.1 (20010917-20220101)  
Relative humidity - Rotronic

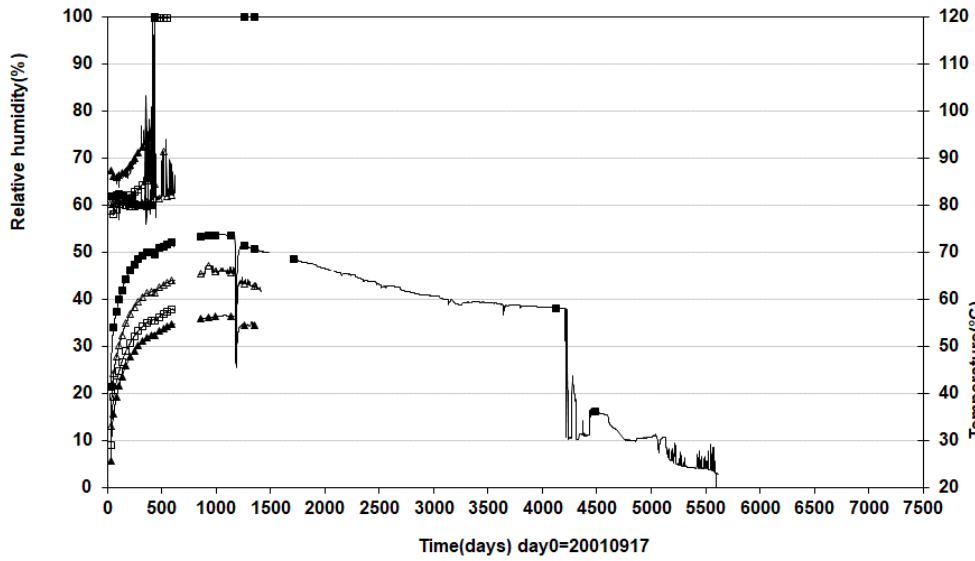

□ WBU30001(0.045\180°\0.050)	△ WBU30002(0.215\0°\0.400)
■ WBU30003(0.245\180°\0.100)	▲ WBU30008(0.245\80°\0.685)

Prototype\Hole 3\Cyl.1 (20010917-20220101)  
Relative humidity - Rotronic

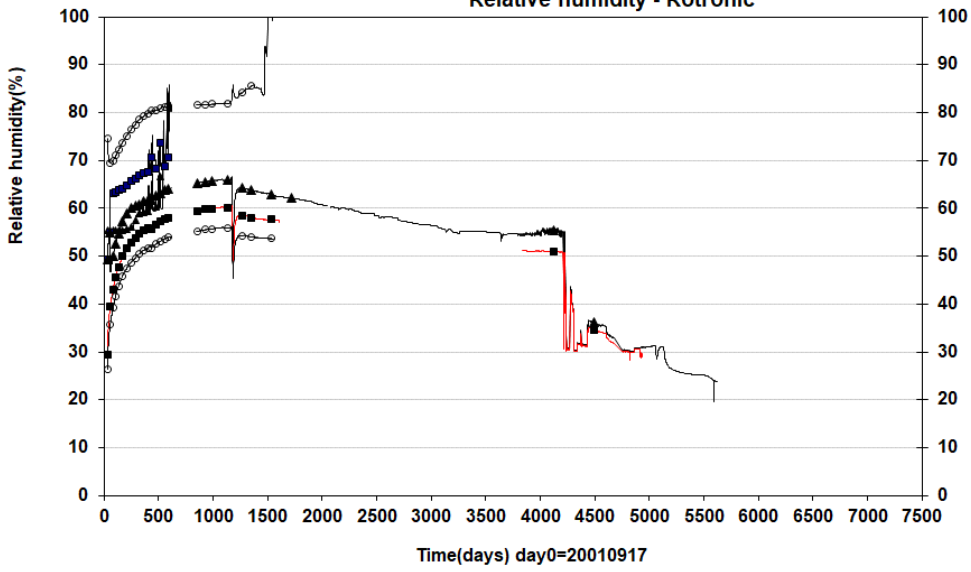

▲ WBU30010(0.245\170°\0.585)    ■ WBU30011(0.245\170°\0.685)    ○ WBU30012(0.245\170°\0.785)

Prototype\Hole 3\Ring 5 (20010917-20220101)  
Relative humidity - Rotronic

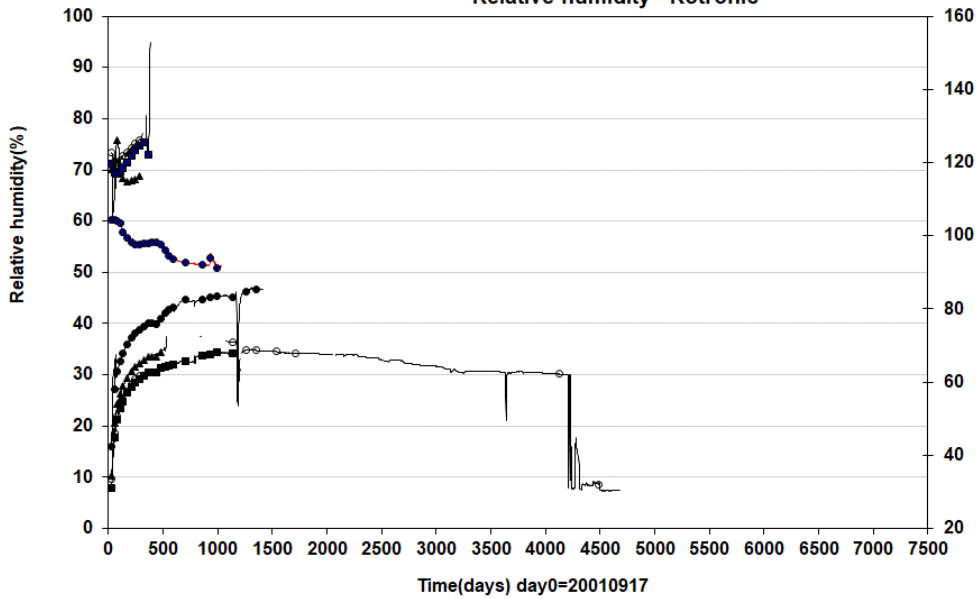

● WBU30016(2.750\180°\0.535)    ▲ WBU30017(2.750\180°\0.685)  
■ WBU30018(2.750\180°\0.785)    ○ WBU30021(2.750\180°\0.785)

Prototype\Hole 3\Ring 10 (20010917-20220101)  
Relative humidity - Rotronic

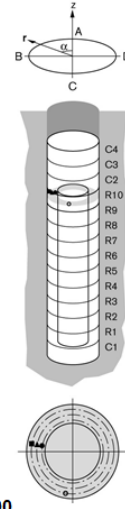
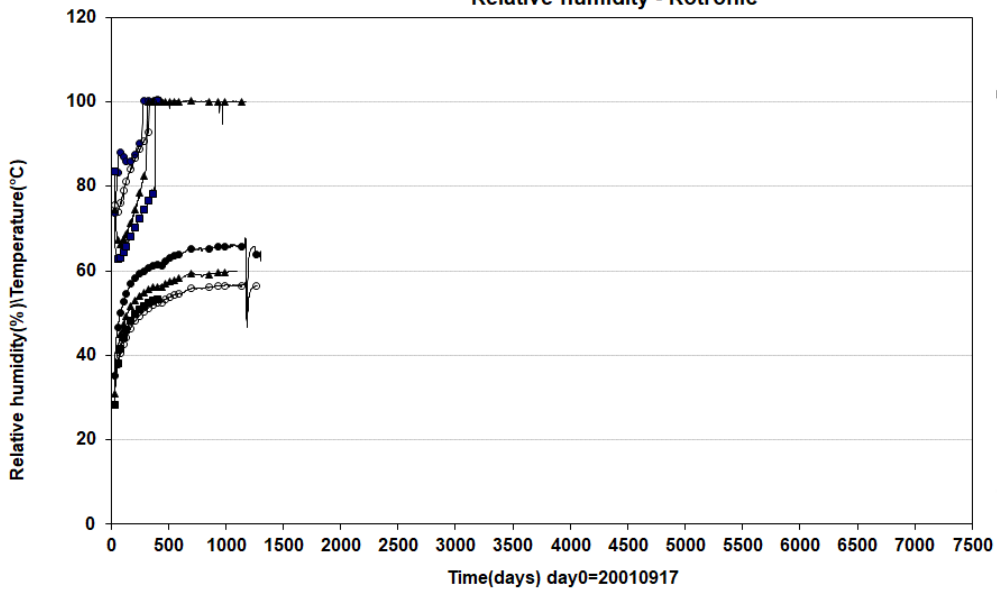

- |                             |                              |
|-----------------------------|------------------------------|
| ● WBU30027(5.306\80°\0.585) | ▲ WBU30028(5.306\80°\0.685)  |
| ■ WBU30029(5.306\80°\0.785) | ○ WBU30031(5.306\170°\0.785) |

Prototype\Hole 3\Cyl.3 (20010917-202210101)  
Relative humidity - Rotronic

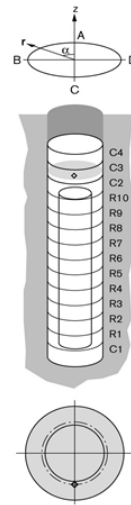
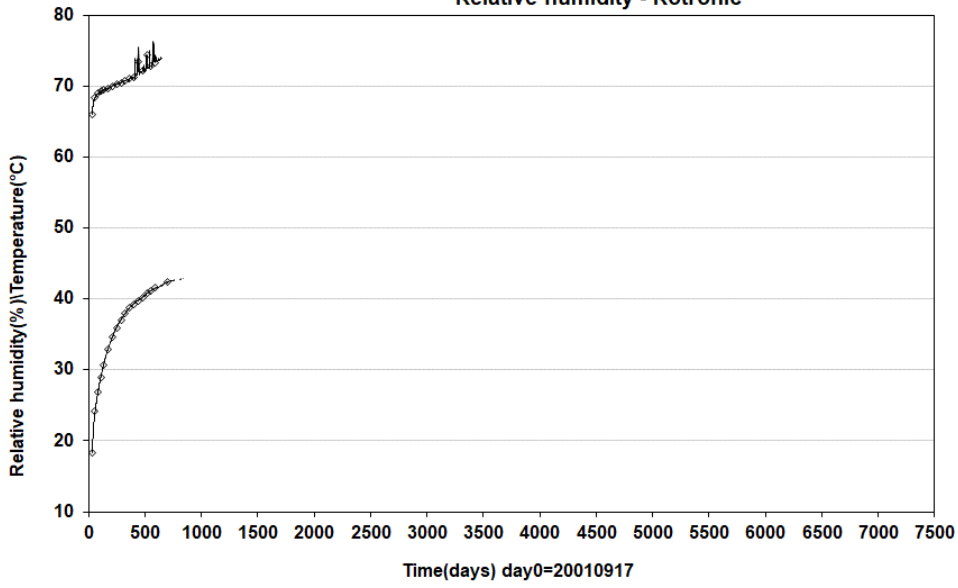

- |                              |
|------------------------------|
| ○ WBU30035(6.314\180°\0.585) |
|------------------------------|

PrototypelHole 3 (20010917-20220101)  
Pore pressure - Geokon

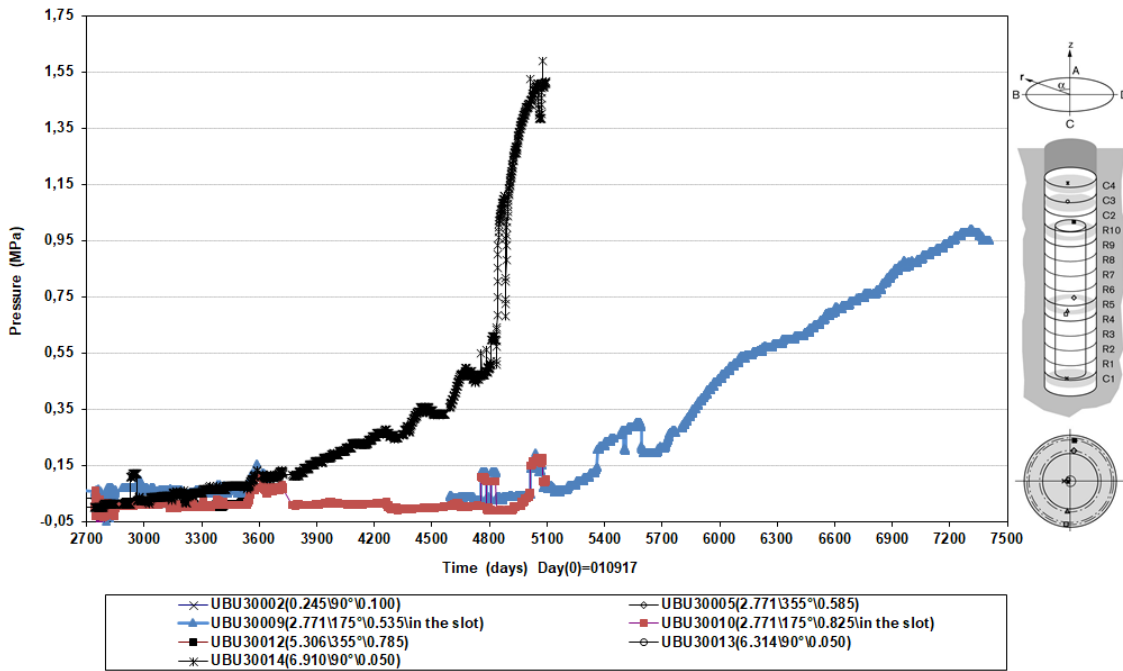

PrototypelHole 3 (20010917-20220101)  
Pore pressure - Kulite

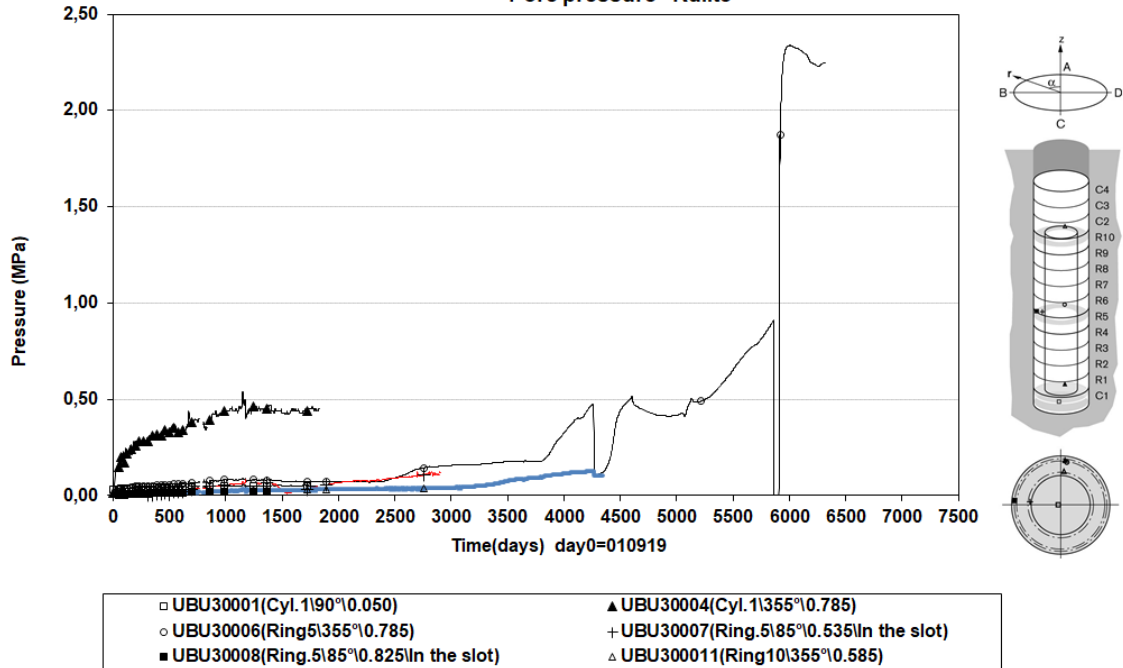

Prototype\Hole 3\Cyl.1 (20010917-20220101)  
Temperature - Pentronic

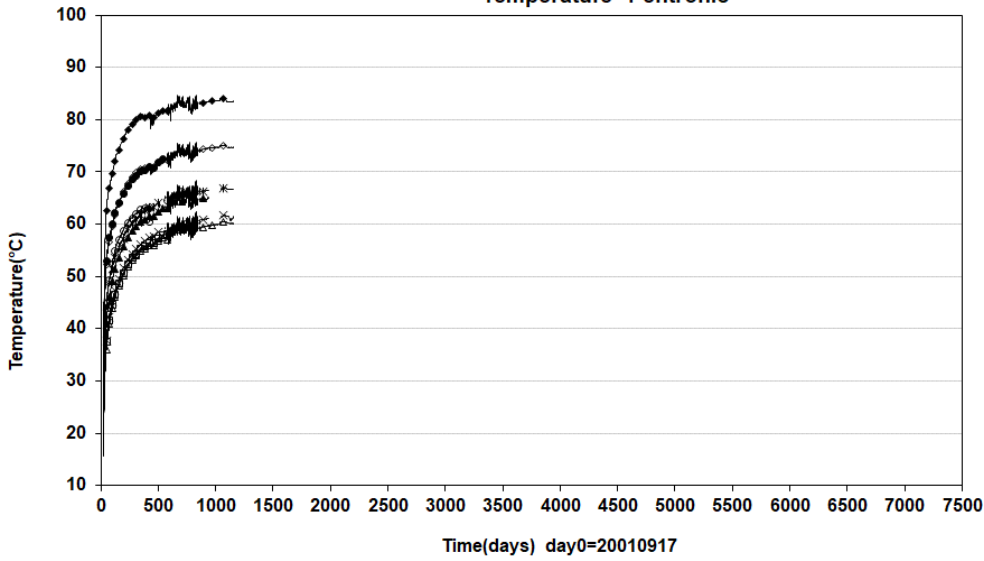

□ TBU30001(0.0951270°\0.050)	◇ TBU30002(0.2951270°\0.050)	◆ TBU30003(0.4451270°\0.050)
▲ TBU30004(Cyl.1\1355°\0.635)	△ TBU30005(Cyl.1\1355°\0.735)	× TBU30006(Cyl.1\185°\0.685)
○ TBU30007(Cyl.1\1175°\0.685)	● TBU30008(Cyl.1\1270°\0.585)	* TBU30009(Cyl.1\1270°\0.685)

Prototype\Hole 3\Ring5 (20010917-20220101)  
Temperature - Pentronic

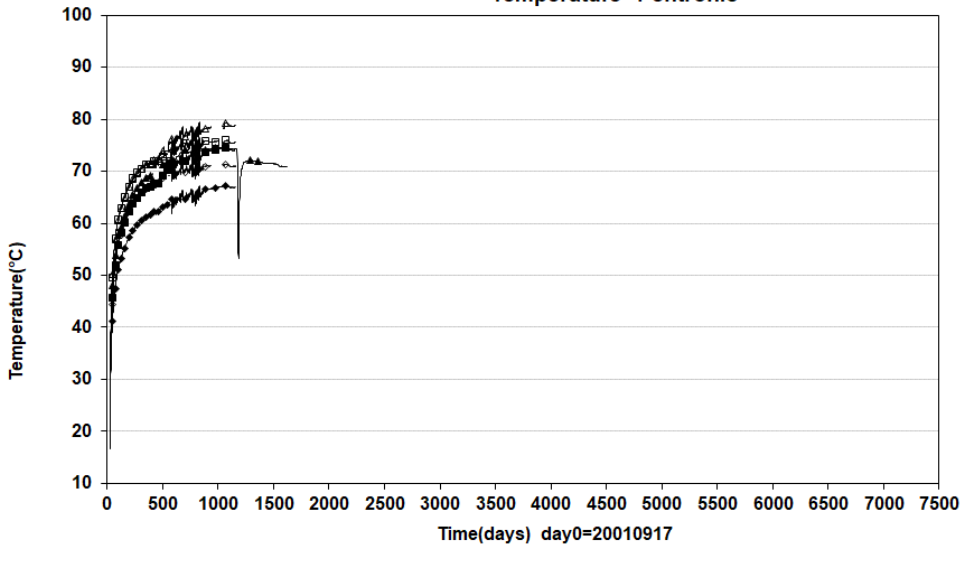

□ TBU30011(2.97110°\0.635)	◇ TBU30012(2.97110°\0.735)	△ TBU30013(2.97190°\0.585)
■ TBU30014(2.97190°\0.685)	◆ TBU30015(2.97190°\0.785)	▲ TBU30017(2.971175°\0.685)

Prototype\Hole 3\Ring5 (20010917-20220101)  
Temperature - Pentronic

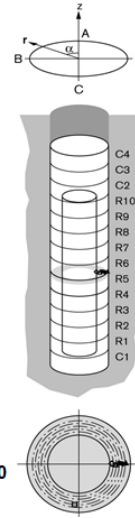
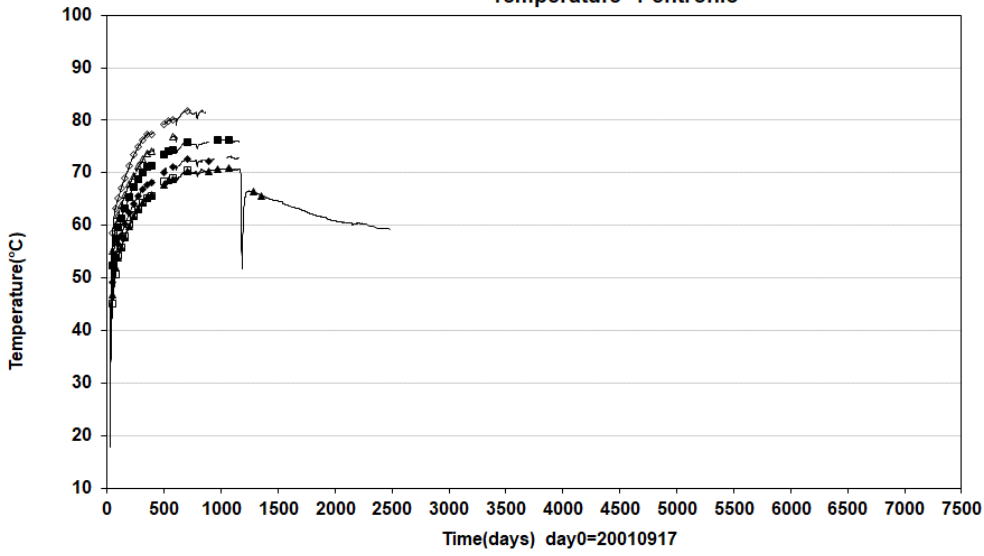

- |                              |                              |                              |
|------------------------------|------------------------------|------------------------------|
| □ TBU30018(2.971\175°\0.735) | ◇ TBU30019(2.971\270°\0.585) | △ TBU30020(2.971\270°\0.635) |
| ■ TBU30021(2.971\270°\0.685) | ◆ TBU30022(2.971\270°\0.735) | ▲ TBU30023(2.971\270°\0.785) |

Prototype\Hole 3\Ring10 (20010917-20220101)  
Temperature - Pentronic

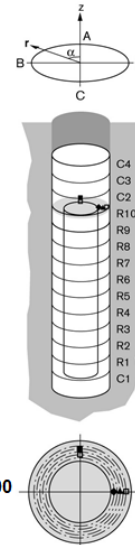
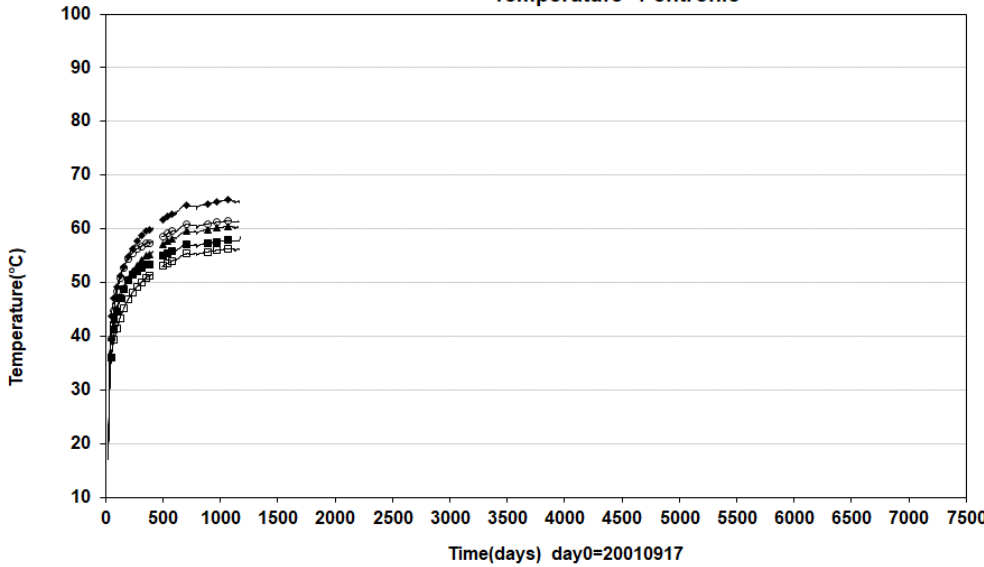

- |                              |                              |                              |
|------------------------------|------------------------------|------------------------------|
| ○ TBU30024(5.504\0°\0.635)   | ■ TBU30025(5.504\0°\0.735)   | ◆ TBU30026(5.504\270°\0.585) |
| ▲ TBU30027(5.504\270°\0.685) | □ TBU30028(5.504\270°\0.785) |                              |

Prototype\Hole 3\Cyl.3 and Cyl.4 (20010917-20220101)  
Temperature - Pentronic

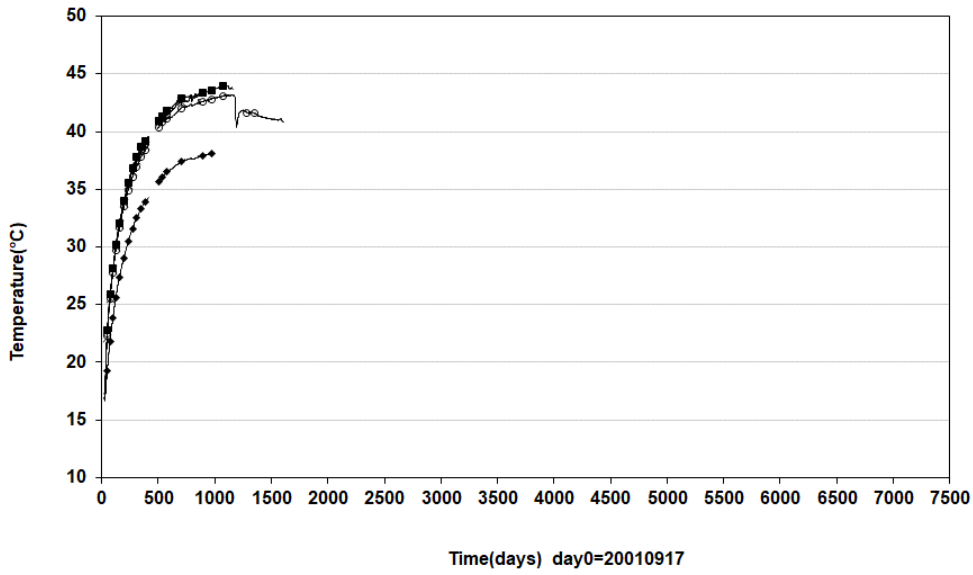

x TBU30029(6.314\0°\0.785)	o TBU30030(6.314\95°\0.585)
■ TBU30031(6.314\185°\0.585)	◆ TBU30032(7.015\0°\0.785)

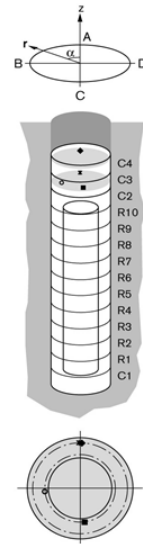

Prototype\Hole 3 (20010917-20220101)  
Temperature - Geokon

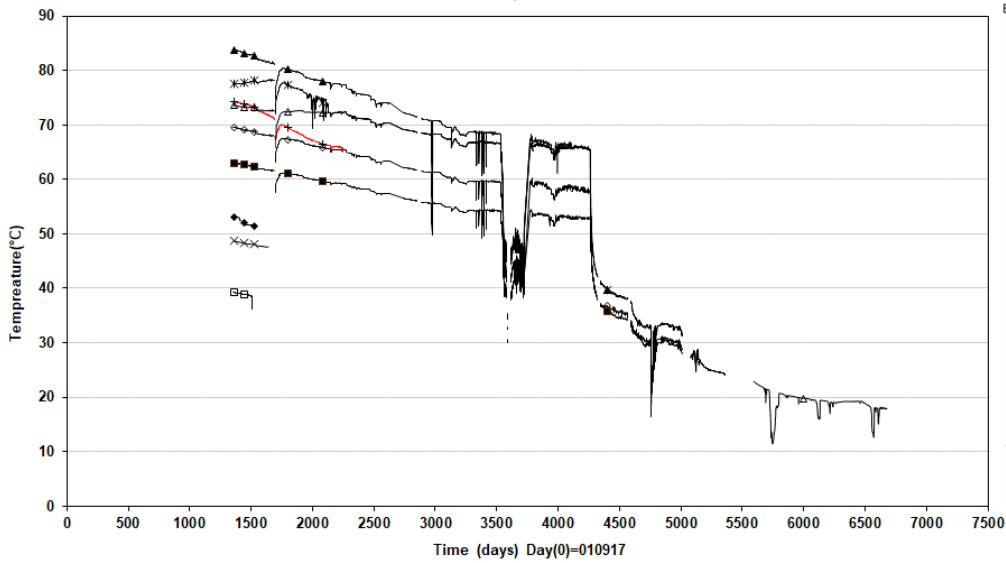

x PBU30001(0\0°\0)	▲ PBU30002(0.495\0°\0.100)	◇ PBU30008(0.495\185°\0.635)	■ PBU30009(0.495\195°\0.735)	x PBU30013(2.771\95°\0.585)
△ PBU30015(3.021\185°\0.535)	+ PBU30017(5.556\0°\0.050)	◆ PBU30022(5.556\100°\0.735)	□ PBU30026(6.654\5°\0.585)	

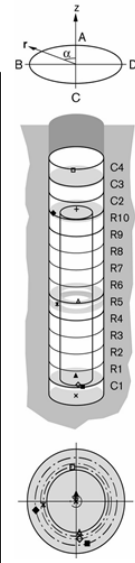



Prototype\Hole 3 (20010917-20220101)  
Temperature - Geokon

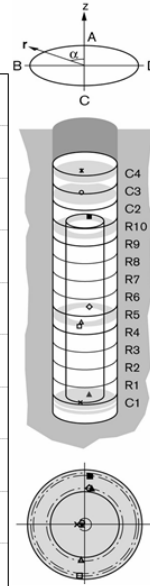
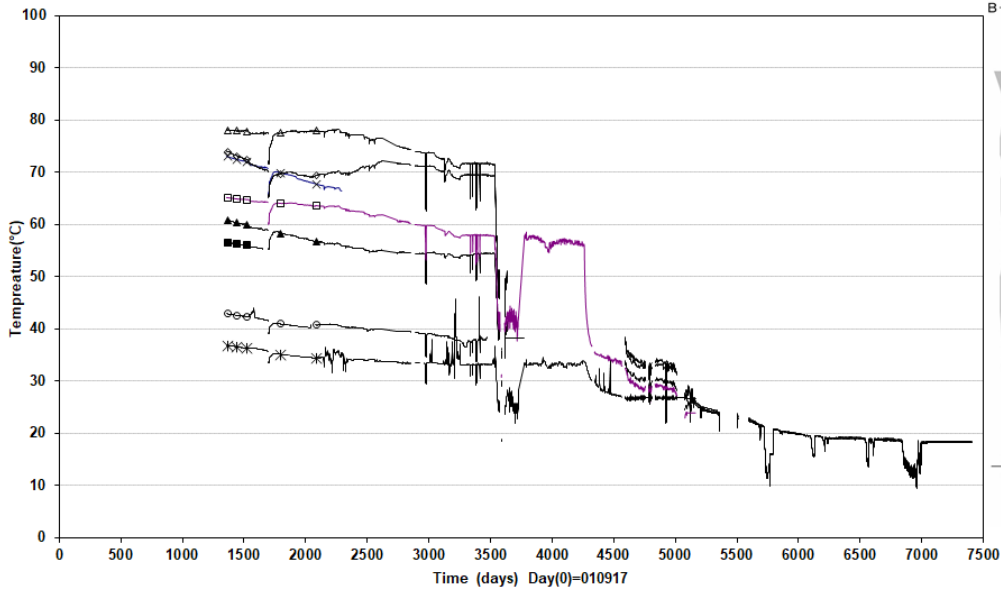

× UBU30002(0.245\90°\0.100)	▲ UBU30003(0.335\355°\0.585)	◇ UBU30005(2.771\355°\0.585)
△ UBU30009(2.771\175°\0.535(in the slot))	□ UBU30010(2.771\175°\0.825(in the slot))	■ UBU30012(5.306\355°\0.785)
○ UBU30013(6.314\90°\0.050)	× UBU30014(6.910\90°\0.050)	

Prototype\Rock\Hole 3 (20010917-20220101)  
Temperature - Pentronic

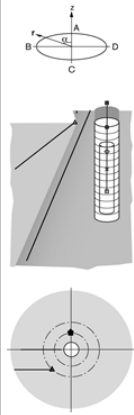
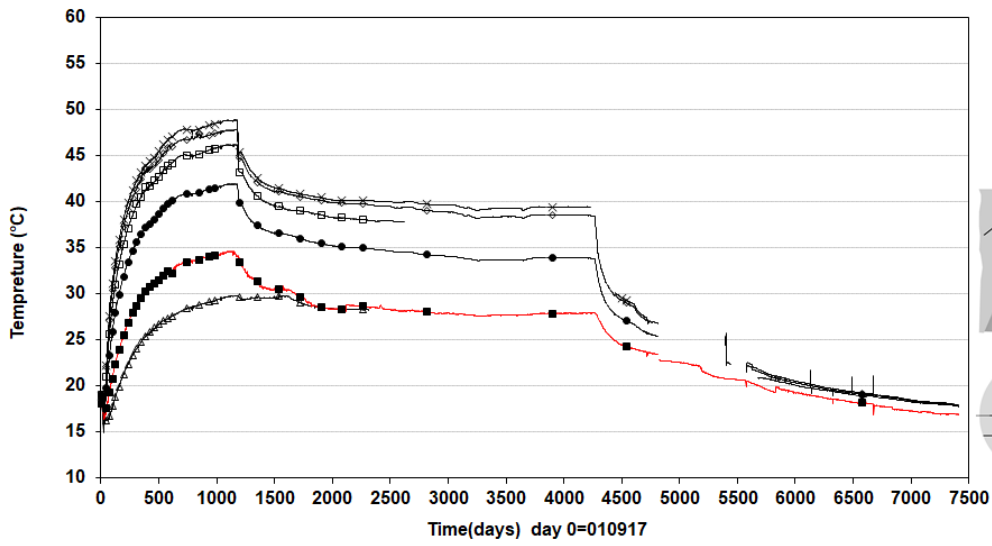

△ TROA2150(7.958\134°\3.284)	● TROA2140 (5.979\1°\1.999)	◇ TROA2130(4.230\2°\1.981)
× TROA2120(2.840\2°\1.967)	□ TROA2110(1.170\3°\1.950)	■ TROA1850 (7.889\0°\2.019)

Prototype\Rock\Hole 3 (20010917-20220101)  
Temperature - Pentronic

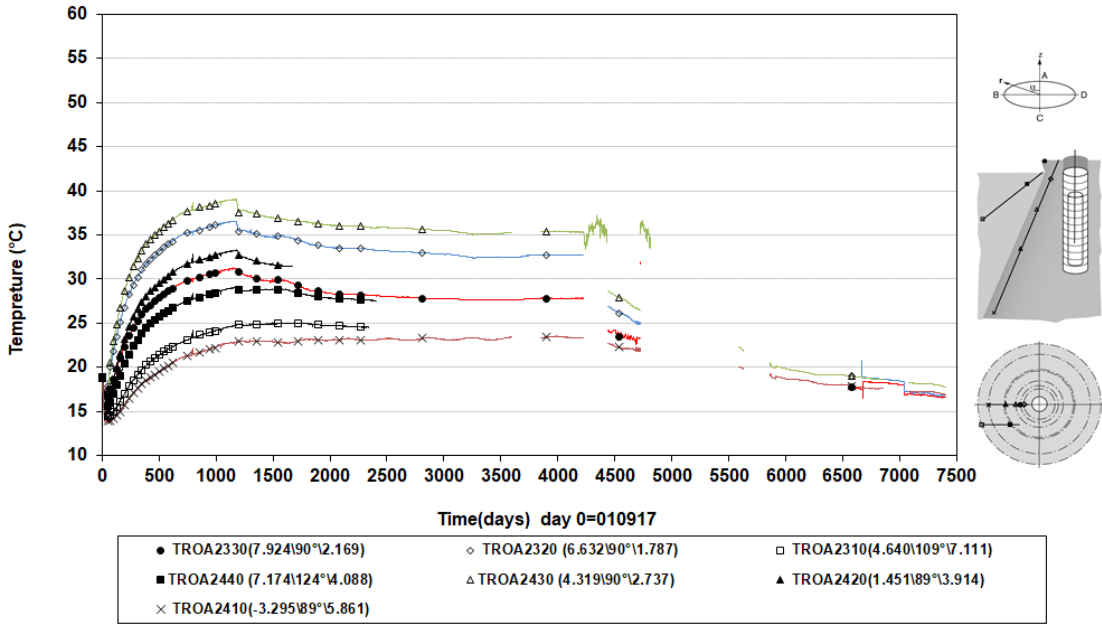

Prototype\Hole 3 (20010917-20220101)  
Canister power

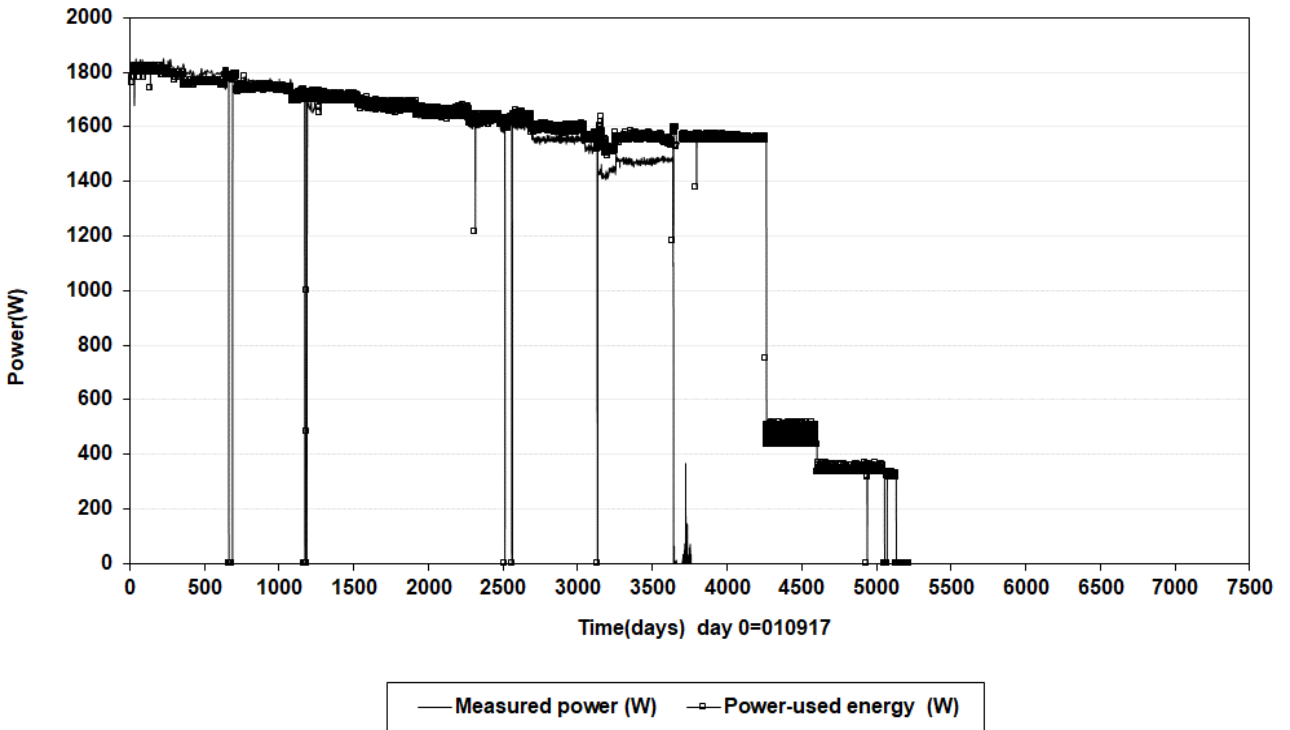

Prototype\ Hole 3 \Canister (010917-070601)  
 Max. temperature on the canister surface - Optical fibre cables

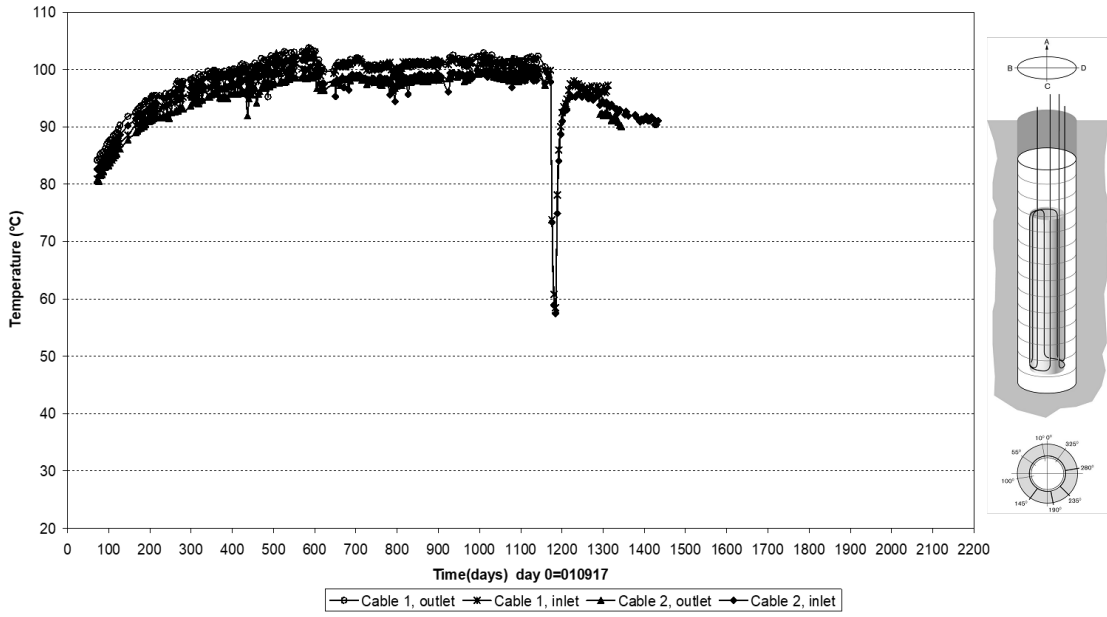

Prototype\ Hole 3 \Canister (050601)  
 Temperature profile on the canister surface - Optical fiber cables

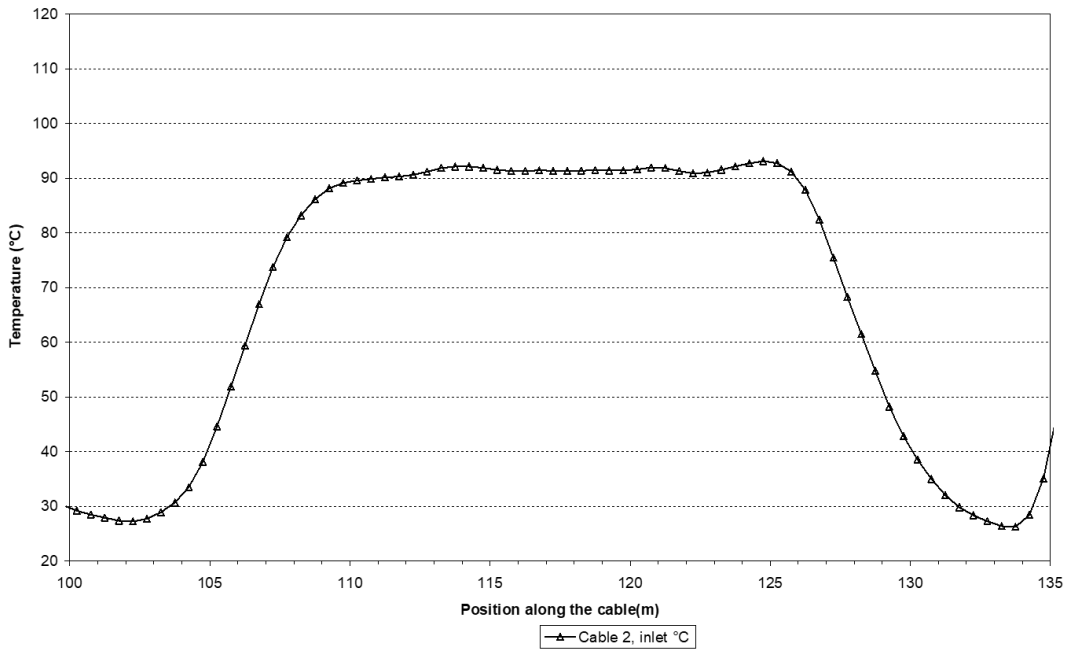

Prototype\Hole 3\ On canister top (20010917-20220101)  
Temperature - Pentronic

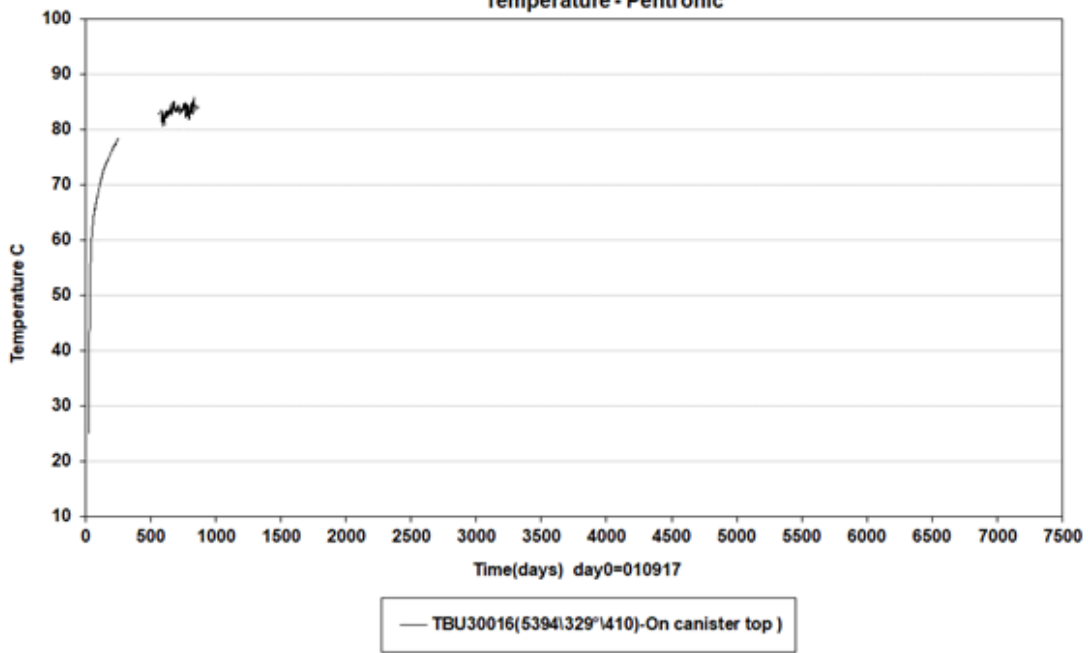

# Appendix 3

## Dep. holes 2 and 4

Prototype\Rock\Hole 2 (20010917-20220101)  
Temperature - Pentronic

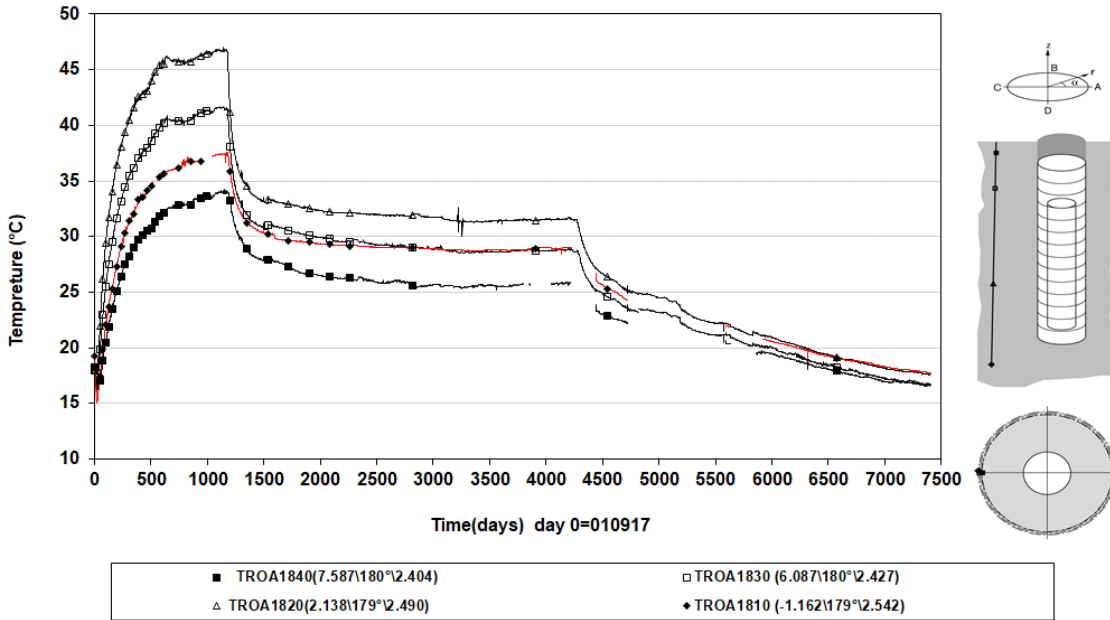

Prototype\Hole 2 (20010917-20220101)  
Canister power

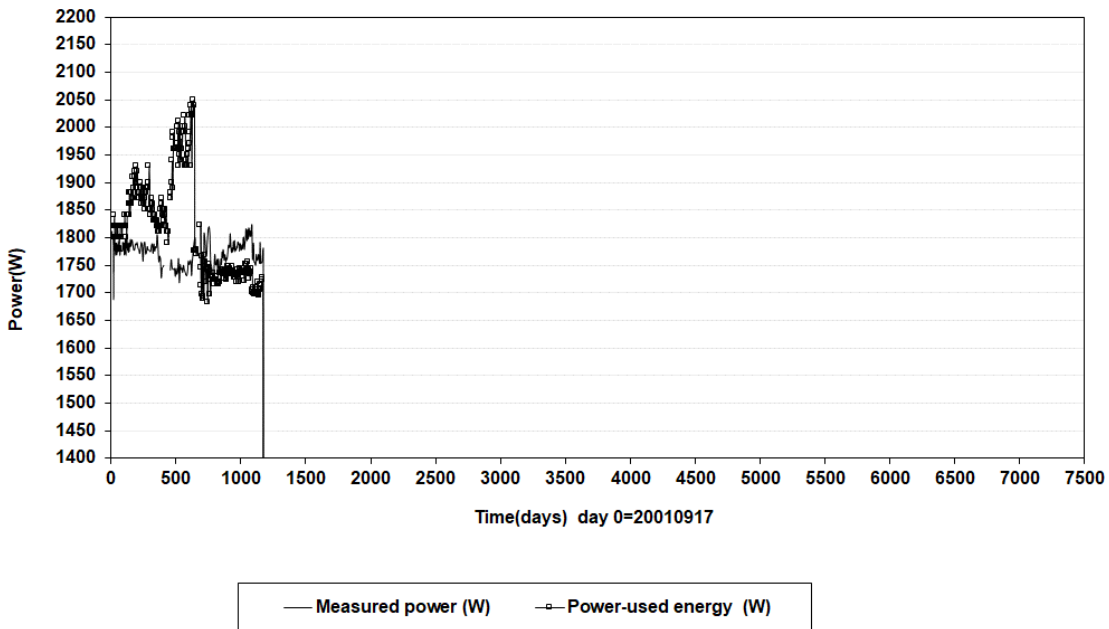

Prototype\ Hole 2 \Canister (010917-070601)  
 Max. temperature on the canister surface - Optical fiber cables



Prototype\ Hole 2 \Canister (050601)  
 Temperature profile on the canister surface - Optical fiber cables

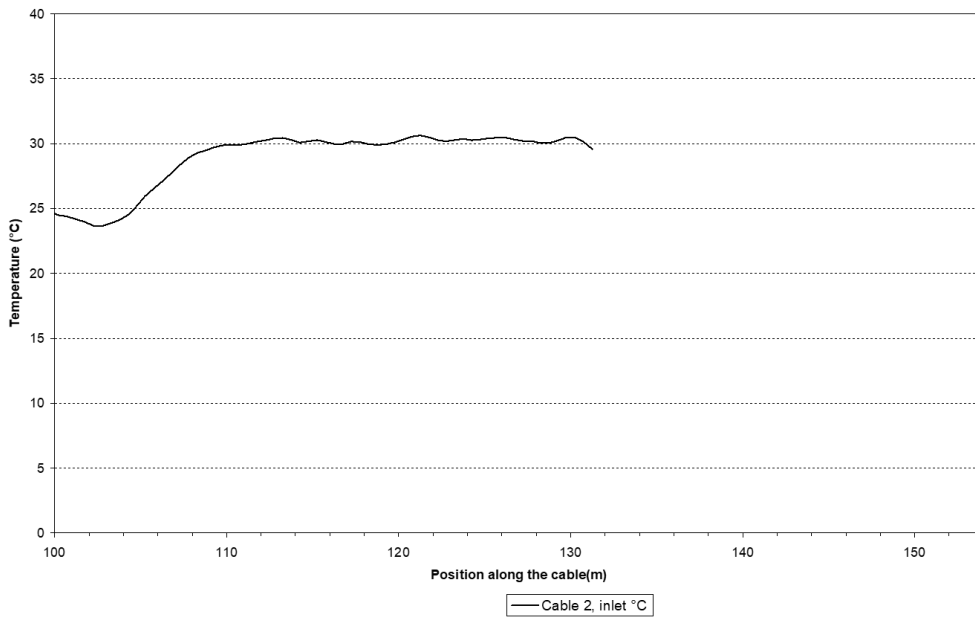

Prototype\Hole 2 \Canister top (20010917-20220101)  
Temperature - Pentronic

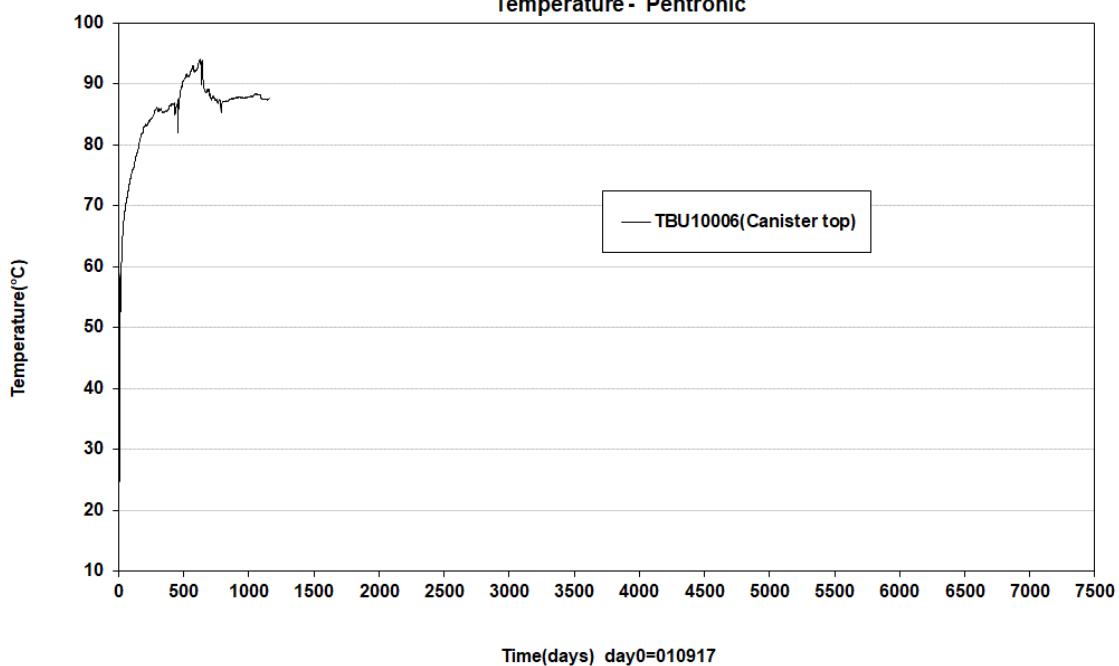

Prototype\Rock\Hole 4 (20010917-20220101)  
Temperature - Pentronic

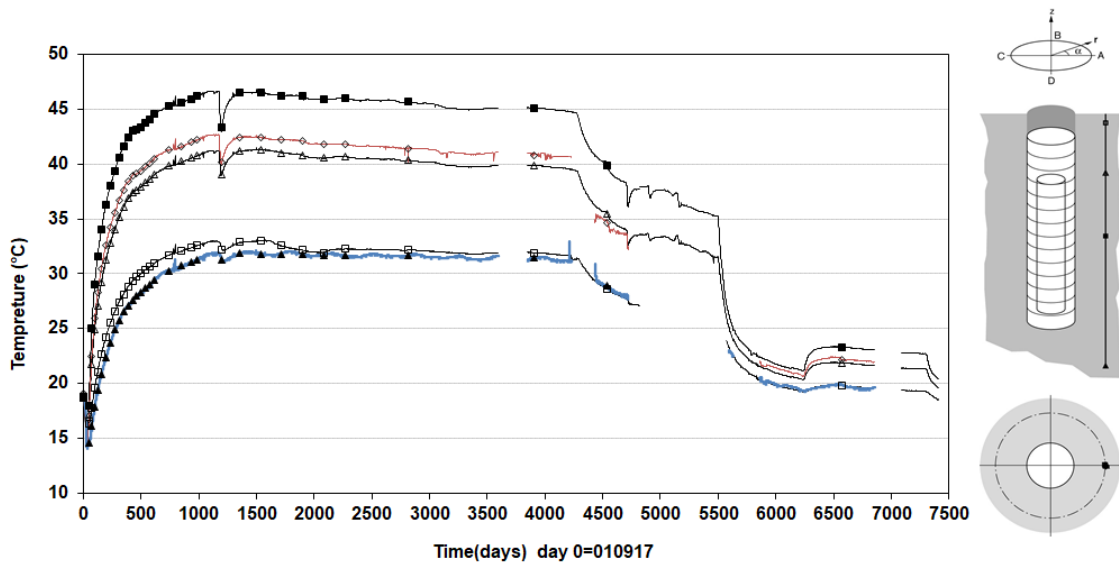

□ TROA3050 (7.671\360°\2.017)	△ TROA3040 (5.671\359°\2.025)	■ TROA3030(3.271\358°\2.034)
◇ TROA3020(0.871\358°\2.045)	▲ TROA3010(-1.778\357°\2.056)	

PrototypeHole 4 (20010917-20220101)  
Canister power

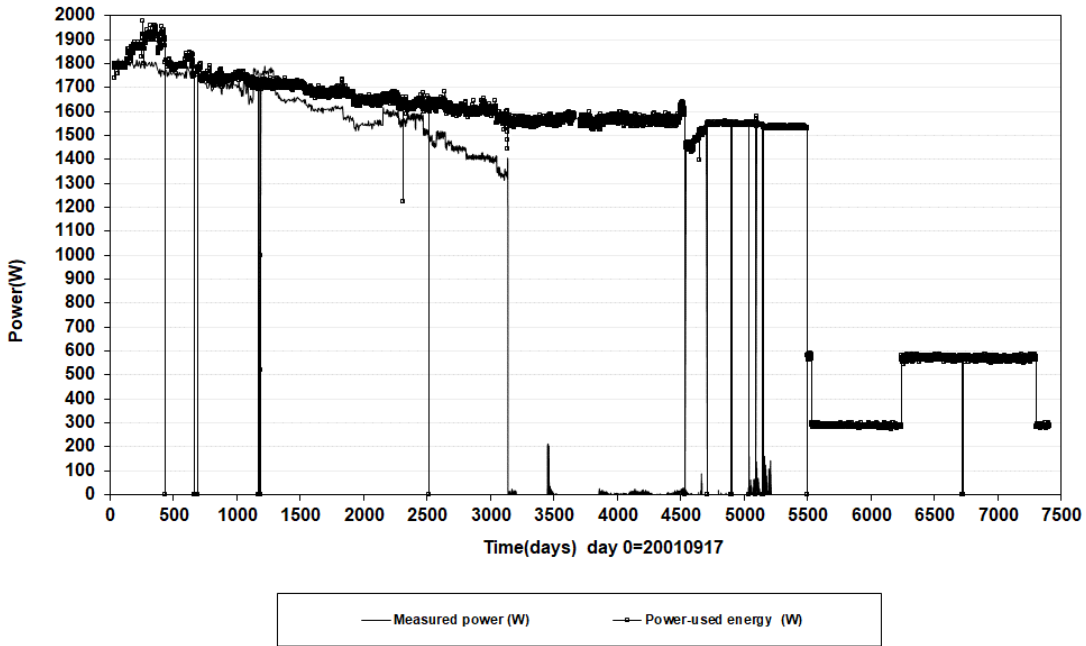

Prototype\ Hole 4 \Canister (010917-070601)  
Max. temperature on the canister surface - Optical fiber cables

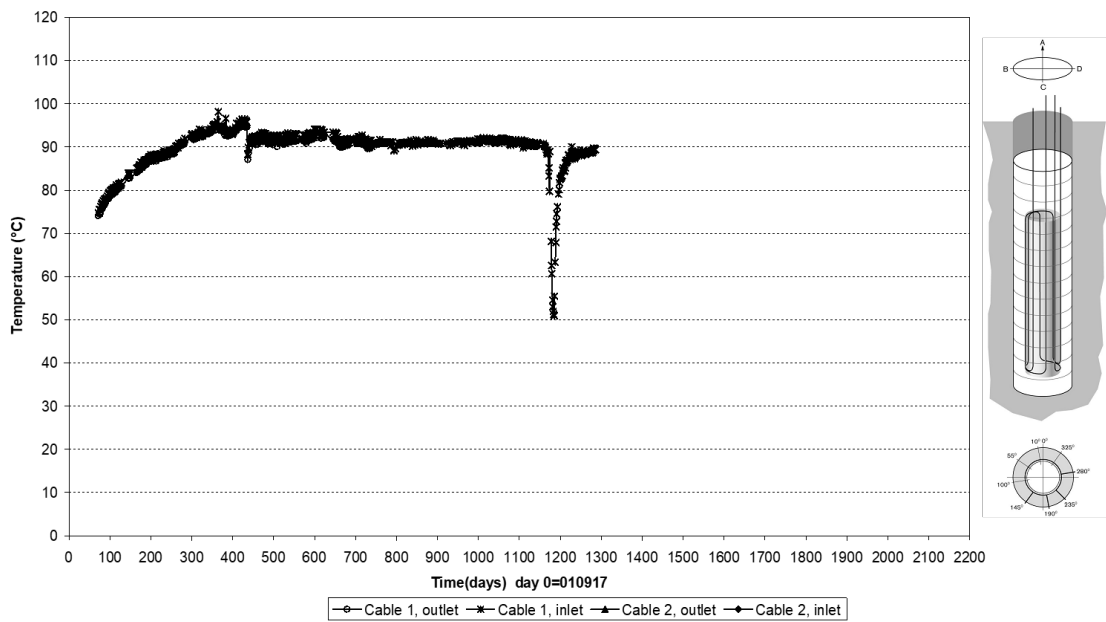



Prototype\ Hole 4\Canister (041130)  
Temperature profile on the canister surface - Optical fiber cables

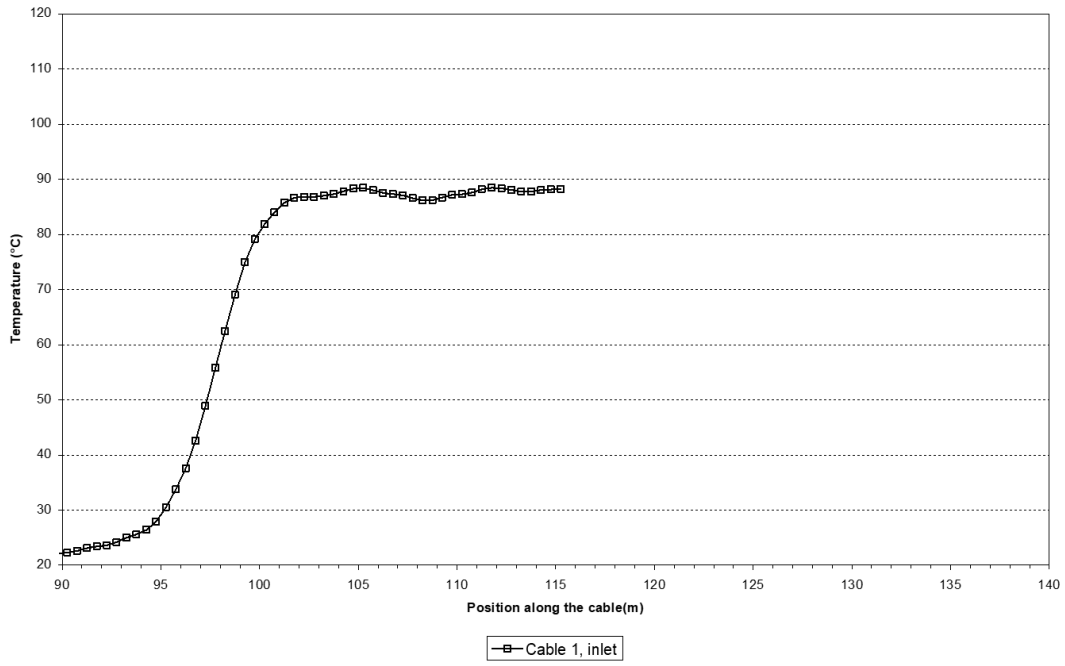

# Appendix 4

## Backfill in section 1

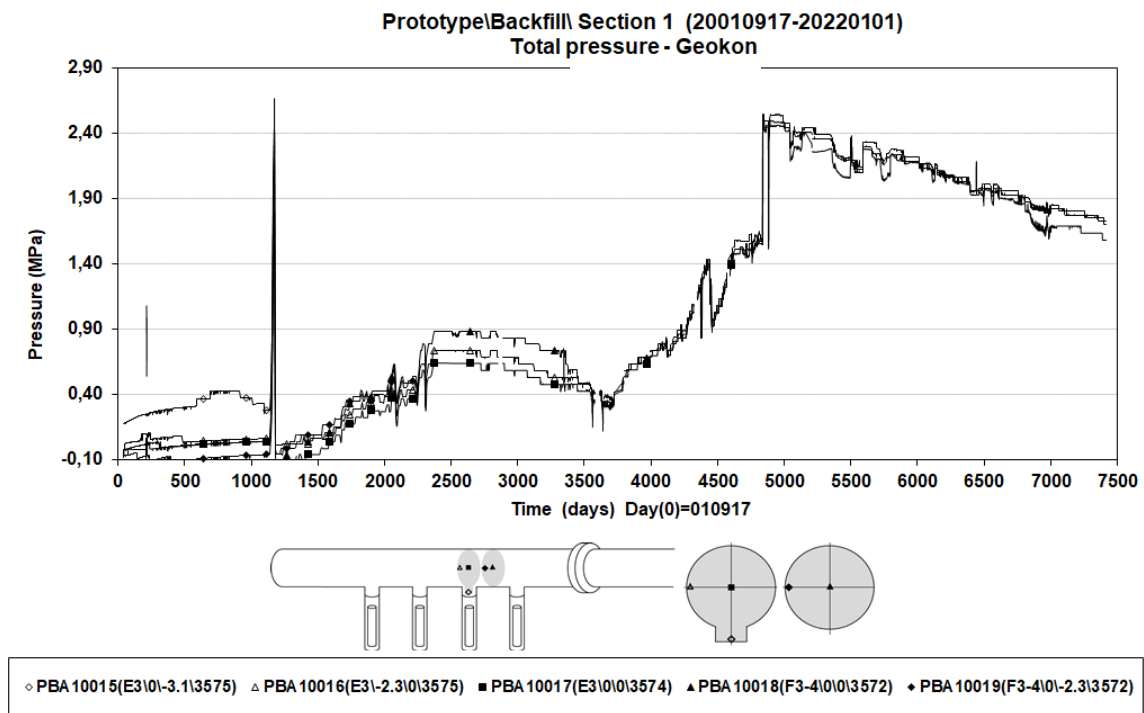
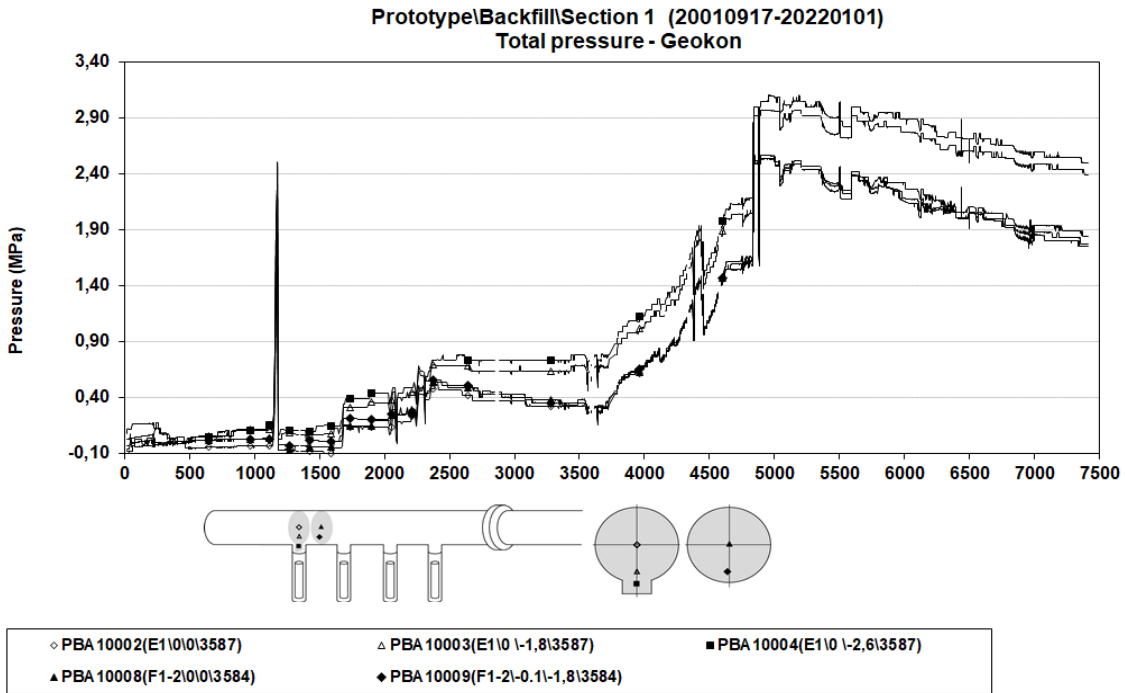

Prototype\Backfill\Section 1 (20010917-20220101)  
Total pressure - Kulite

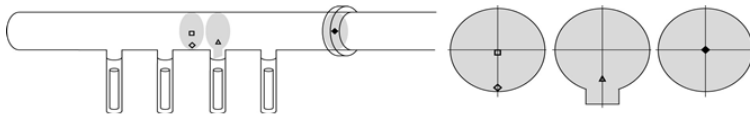
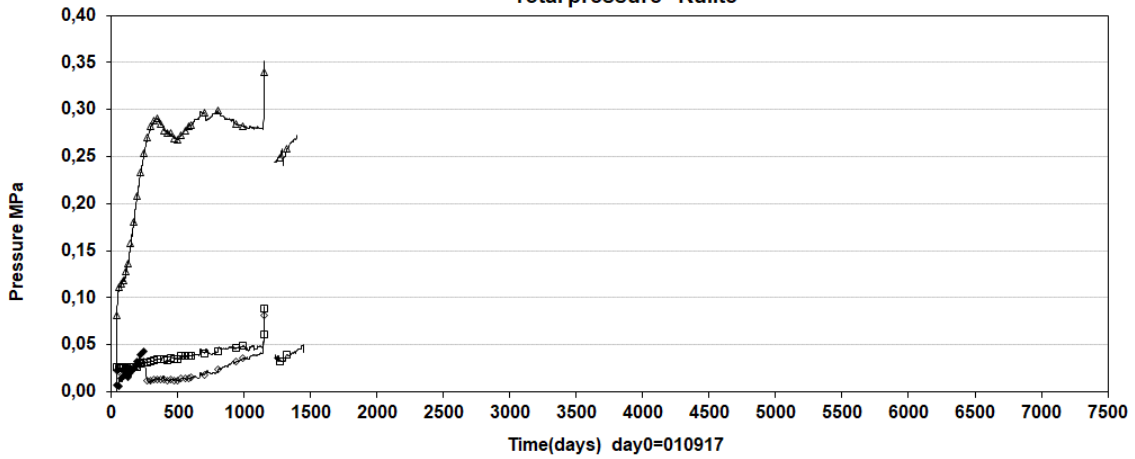

□ PBA10010(F1-210\0.2\3578)    ◇ PBA10011(F1-210\2.3\3578)    △ PBA10013(E3\0\1.82\3575)    ● PBA10020(In front of plug\0\3561)

Prototype\Backfill\Section 1 (20010917-20220101)  
Total pressure - Kulite

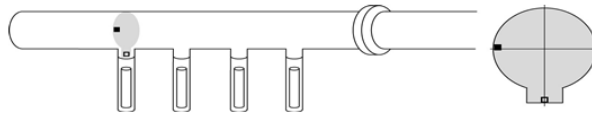
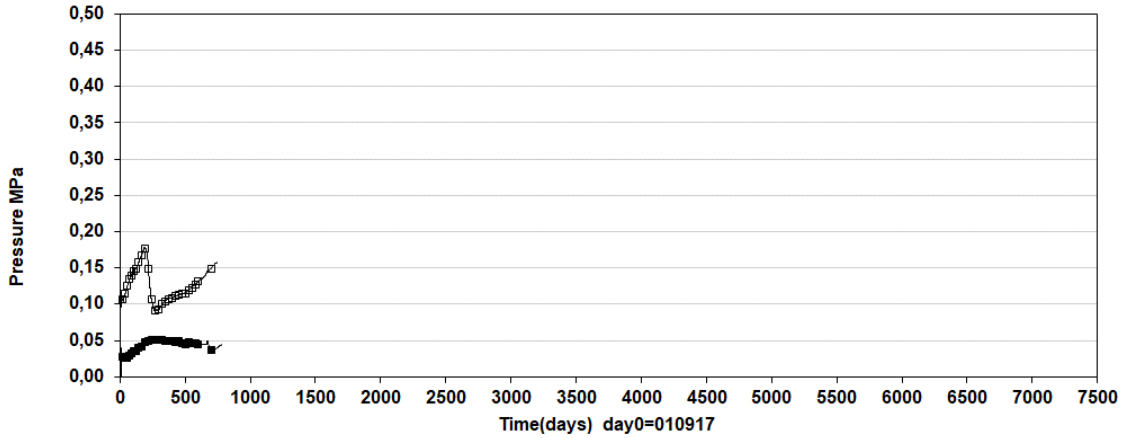

□ PBA10005(E1\0\3.1\3587)    ● PBA10006(E1\2.3\0.1\3587)

Prototype\Backfill \ Inner part (20010917-20220101)  
Suction - Wescor

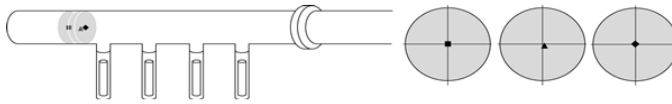
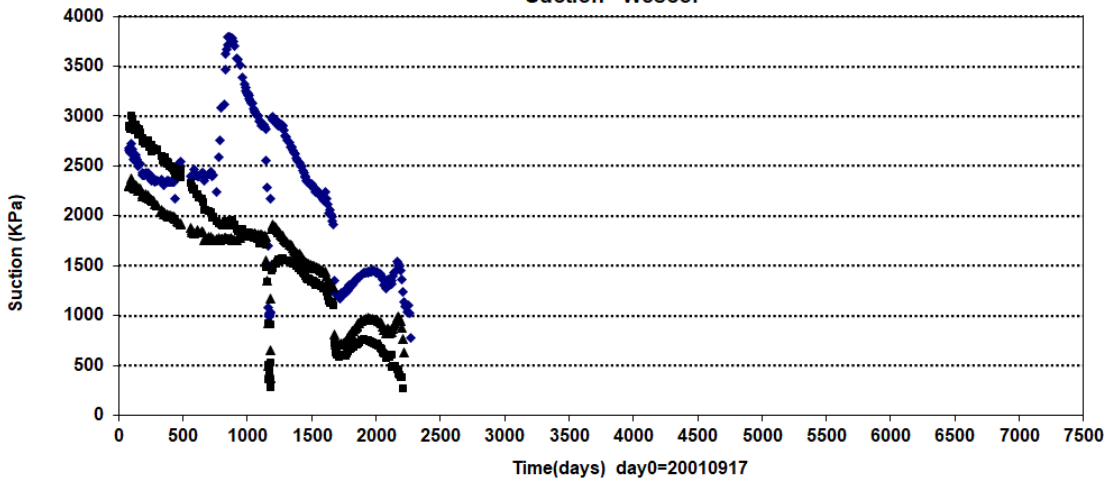

- ◆ WBA10001(Inner part\0\0\3589)
- WBA10002(Inner part\0\0\3592)
- ▲ WBA10003(Inner part\0.1\0.1\3590)

Prototype\Backfill\ Above dep.hole 1 (20010917-20220101)  
Suction - Wescor

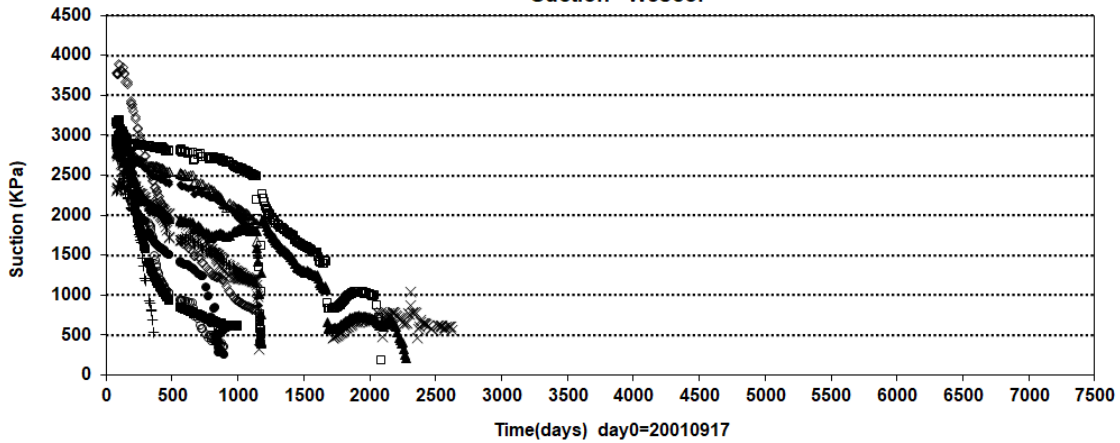

- ◇ WBA10004(E1\0.25\2.3\3587)
- WBA10005(E1\0\1.25\3587)
- ▲ WBA10006(E1\0\0.1\3587)
- × WBA10007(E1\0.1\0.8\3587)
- × WBA10008(E1\0\1.7\3587)
- WBA10009(E1\0.1\2.6\3587)
- + WBA10010(E1\0.5\3.13\3587)
- WBA10011(E1\2.3\0.1\3587)
- △ WBA10012(E1\1.3\0\3587)
- ◆ WBA10013(E1\1.3\0\3587)
- WBA10014(E1\2.3\0\3587)

PrototypelBackfill \ Between dep.hole 1 and hole 2 (20010917-20220101)  
Suction - Wescor

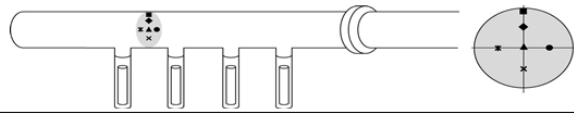
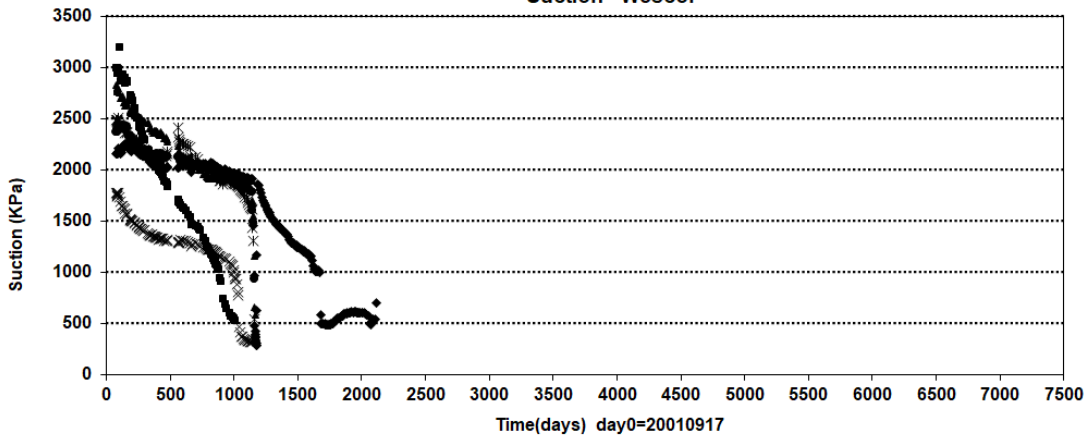

- ◆ WBA10015(F1-2|0|1.3|3584)    ■ WBA10016(F1-2|0|2.3|3584)    ▲ WBA10017(F1-2|0|0|3584)
- × WBA10018(F1-2|0|1.3|3584)    ✕ WBA10019(F1-2|1-1.3|0|3584)    ● WBA10020(F1-2|1.3|0|3584)

PrototypelBackfill \ Between dep.hole 2 and hole 3 (20010917-20220101)  
Suction - Wescor

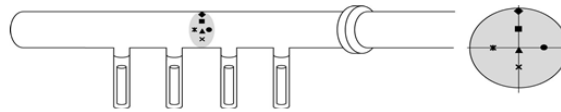
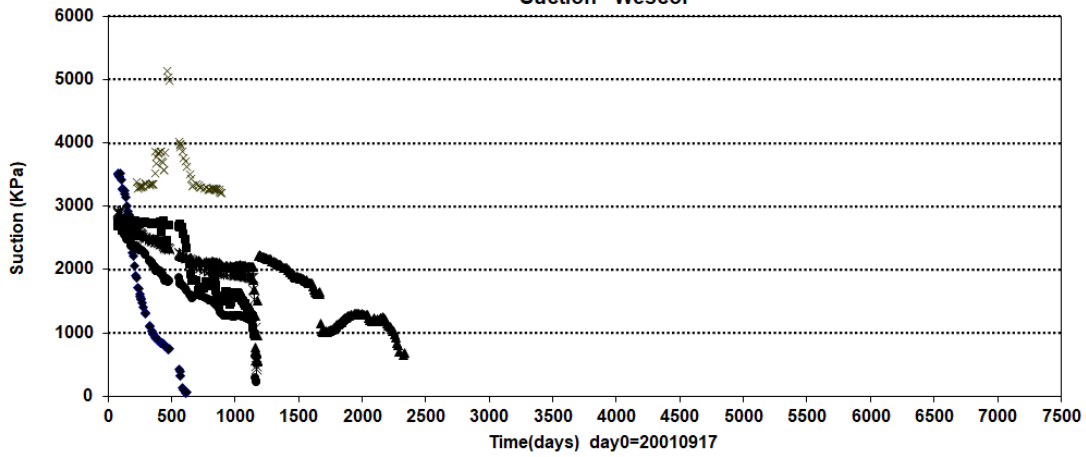

- ◆ WBA10021(F2-3|0|2.3|3578)    ■ WBA10022(F2-3|0|1.2|3578)    ▲ WBA10023(F2-3|0|0.2|3578)
- × WBA10025(F2-3|1-1.3|0|3578)    ● WBA10026(F2-3|1.3|0|3578)    ✕ WBA10024(F2-3|0|1.2|3578)

Prototype\Backfill Above dep.hole 3 (20010917-20220101)  
Suction - Wescor

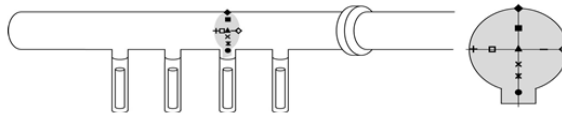
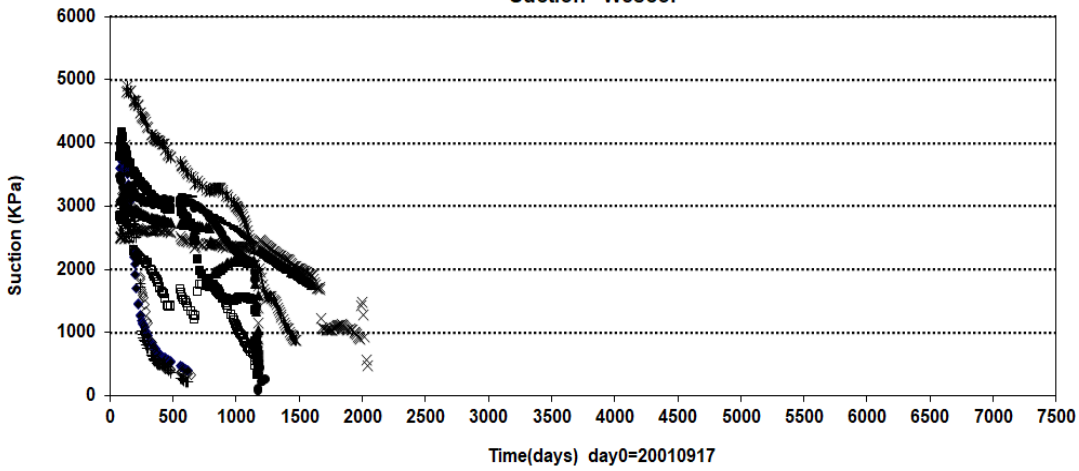

- |                             |                                 |                             |                             |
|-----------------------------|---------------------------------|-----------------------------|-----------------------------|
| ◆ WBA10027(E3\0\2.5\3574)   | ■ WBA10028(E3\0\1.3\3575)       | ▲ WBA10029(E3\0\0\3575)     | × WBA10030(E3\0\-.9\3575)   |
| ✱ WBA10031(E3\0\-.1.6\3575) | ● WBA10032(E3\-.0.3\-.2.6\3575) | + WBA10034(E3\-.2.3\0\3575) | □ WBA10035(E3\-.1.3\0\3575) |

Prototype\Backfill \ Between dep.hole 3 and hole 4 (20010917-20220101)  
Suction - Wescor

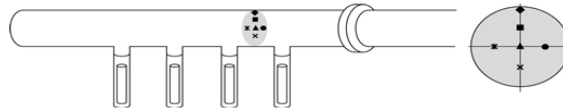
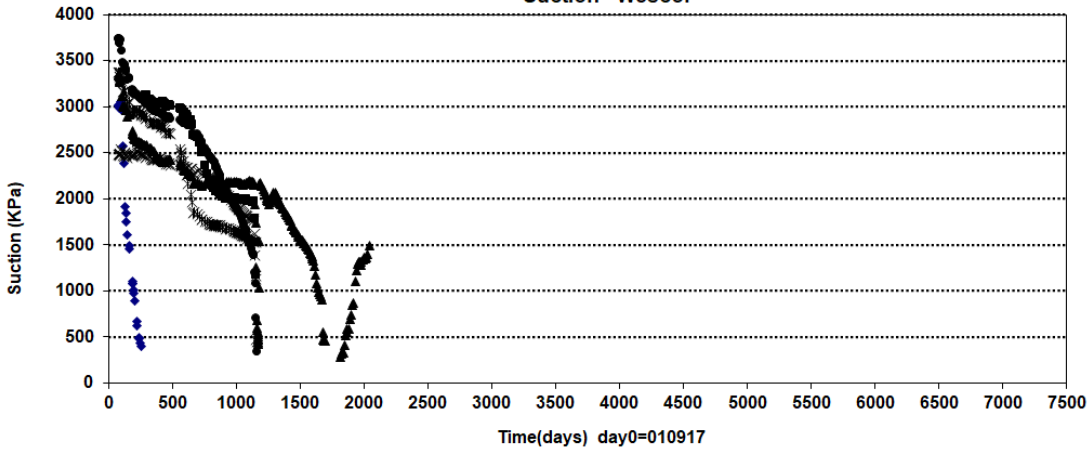

- |                                |                                |                              |
|--------------------------------|--------------------------------|------------------------------|
| ◆ WBA10038(F3- 4\0\2.3\3572)   | ■ WBA10039(F3- 4\0\1.2\3572)   | ▲ WBA10040(F3- 4\0\0\3572)   |
| × WBA10041(F3- 4\0\-.1.3\3572) | ✱ WBA10042(F3- 4\-.1.3\0\3572) | ● WBA10043(F3- 4\1.3\0\3572) |

Prototype\Backfill \ In front of plug (20010917-20220101)  
Suction - Wescor

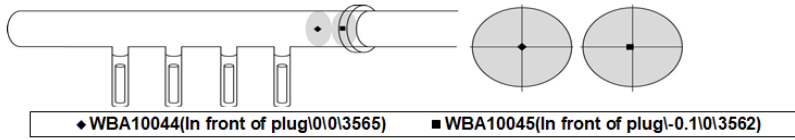
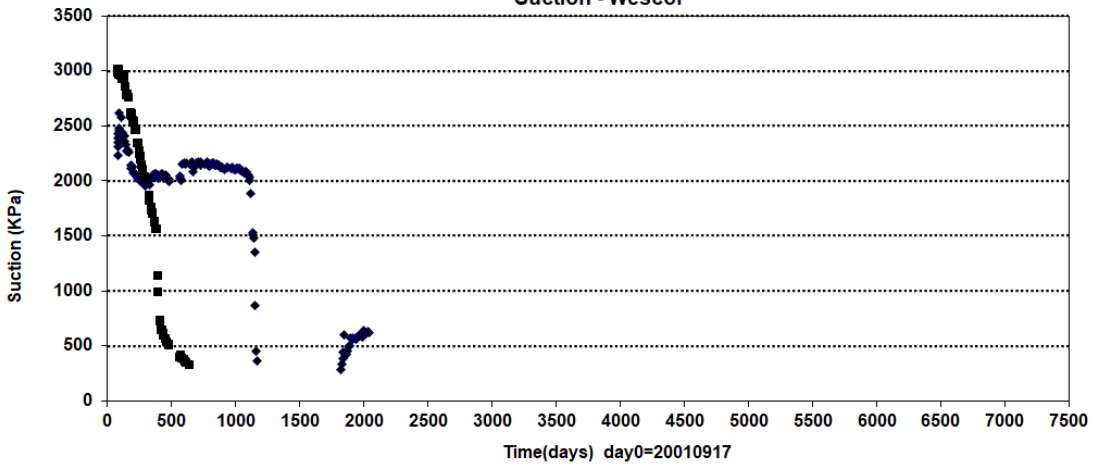

Prototype\Backfill\Section 1 (20010917-20220101)  
Pore pressure - Geokon

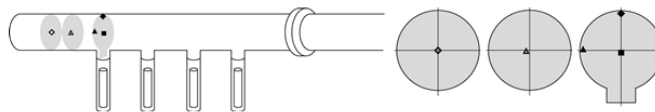
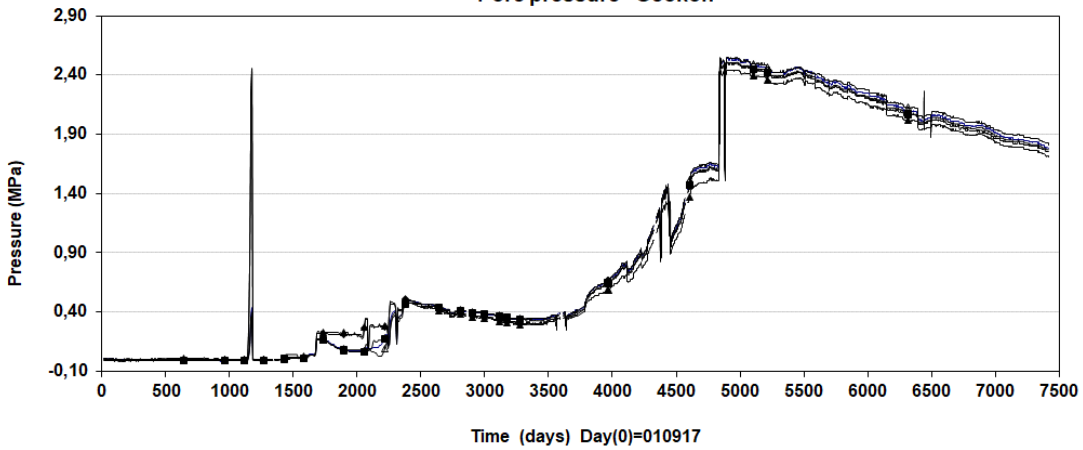

- ◇ UBA 10002(Inner part\0\0\3592)
- △ UBA 10003(Inner part\0.2\0.1\3590)
- UBA 10004(E1\0\0\3587)
- ▲ UBA 10008(E1\1-2.3\0\3587)
- ◆ UBA 10009(E1\0\2.3\3587)

Prototype\Backfill \ Section 1 (20010917-20220101)  
Pore pressure - Geokon

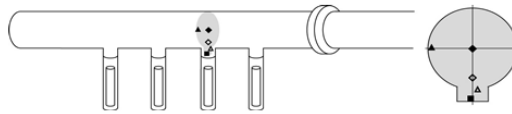
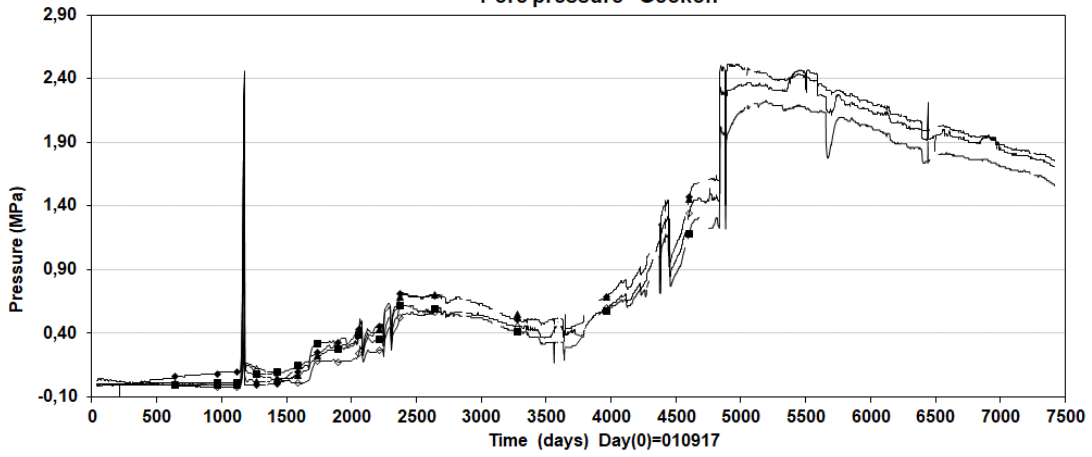

- |                               |                                 |                                  |
|-------------------------------|---------------------------------|----------------------------------|
| ◇ UBA 10015(E3\0\1-1.82\3575) | △ UBA 10016(E3\0.25\2-2.6\3575) | ■ UBA 10017(E3\0-0.1\3-3.1\3575) |
| ▲ UBA 10018(E3\1-2.3\0\3575)  | ◆ UBA 10019(E3\0\0\3574)        |                                  |

Prototype\Backfill Section 1 (20010917-20220101)  
Pore pressure - Kulite

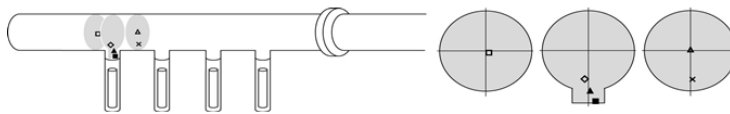
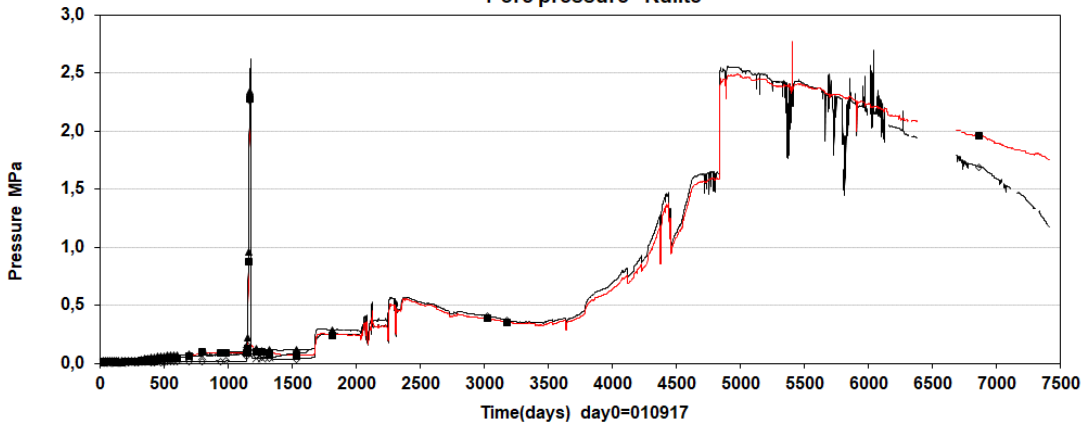

- |  |                                  |                                  |
|--|----------------------------------|----------------------------------|
| □ UBA 10001(Inner part\0.2\0-1.1\3589) | ◇ UBA 10005(E1\0-0.2\1-1.8\3587) | ▲ UBA 10006(E1\0.1\2-2.6\3587)   |
| ■ UBA 10007(E1\0.4\3-2\3587)           | △ UBA 10010(F1-2\0\0\3584)       | × UBA 10011(F1-2\0.1\1-1.2\3584) |



PrototypelBackfill \Section 1 (20010917-20220101)  
Pore pressure - Kulite

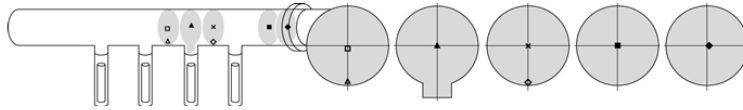
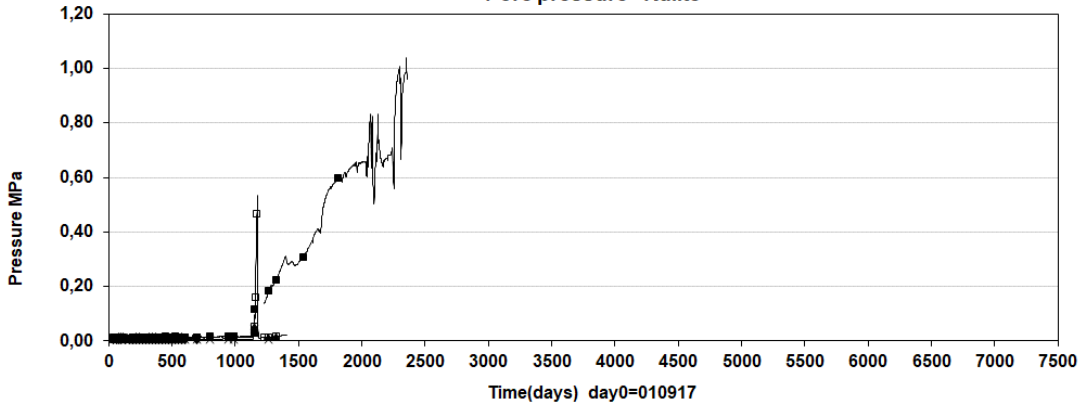

□ UBA10012(F2-3\0\0-2\3\578)	△ UBA10013(F2-3\0\0-2.3\3578)	▲ UBA10014(E3\0\0\3575)
× UBA10020(F3-4\0\0\3572)	◇ UBA10021(F3-4\0\0-2.3\3572)	■ UBA10022(In front of plug\0\0\3565)
◆ UBA10023(In front of plug\0.1\0\3561)		

Prototypel Backfill \ Above dep.hole1 (20010917-20220101)  
Temperature - Pentronic

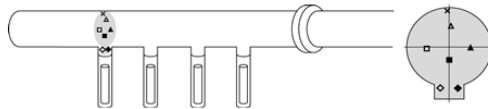
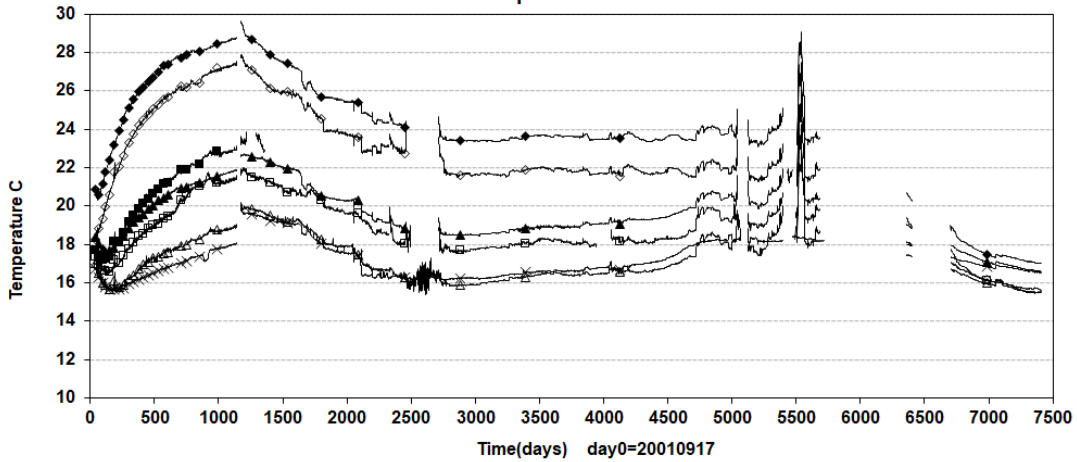

□ TBA10001(E1\1-1.25\0-0.1\3587)	△ TBA10002(E1\0.1\1.3\3587)	■ TBA10003(E1\0\0-0.8\3587)
◇ TBA10004(E1\1-0.5\1-2.6\3587)	◆ TBA10005(E1\0.5\1-2.6\3587)	× TBA10006(E1\1-0.1\2.3\3587)
▲ TBA10007(E1\1.25\0-0.1\3587)		

Prototype\ Backfill \ Between dep.hole 1-2 (20010917-20220101)  
Temperature - Pentronic

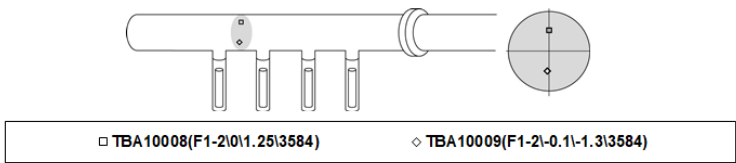
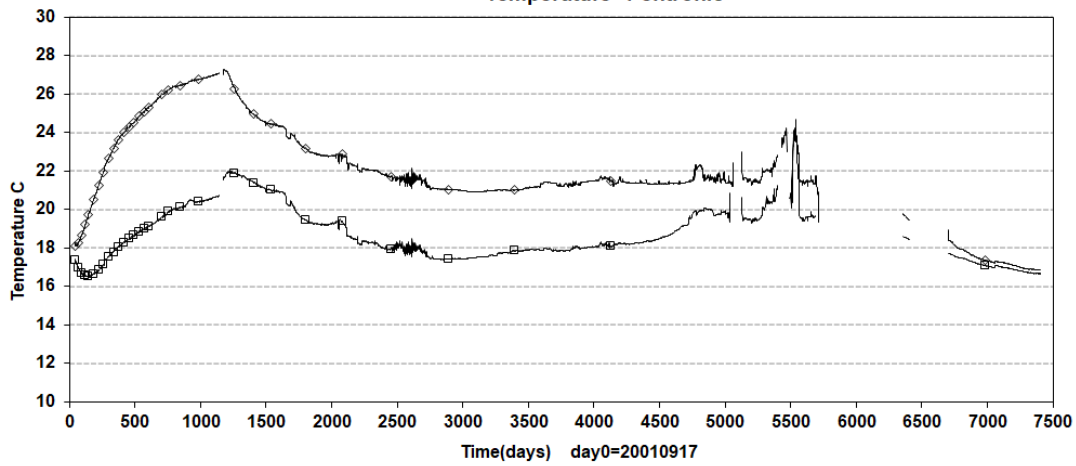

Prototype\ Backfill \ Between dep.hole 2-3 (20010917-20220101)  
Temperature - Pentronic

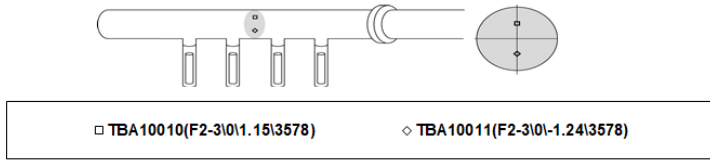
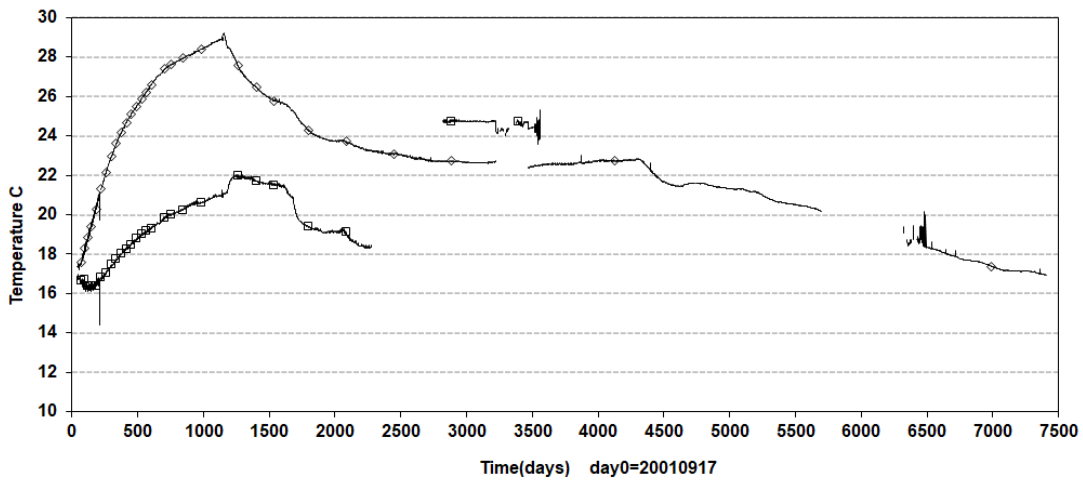

Prototype\ Backfill \ Above dep.hole3 (20010917-20220101)  
Temperature - Pentronic

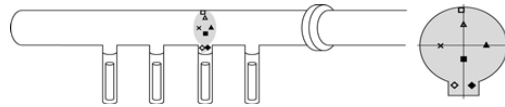
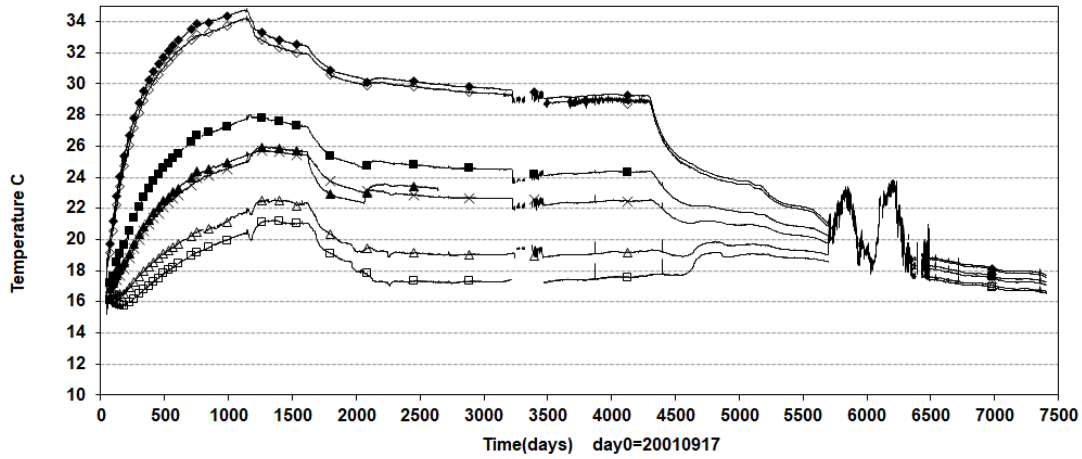

- |                             |                             |                           |
|-----------------------------|-----------------------------|---------------------------|
| □ TBA10012(E3\0.1\2.3\3575) | △ TBA10013(E3\0\1.3\3575)   | ■ TBA10014(E3\0\0.9\3575) |
| ◇ TBA10015(E3\0.5\2.6\3575) | ◆ TBA10016(E3\0.5\2.6\3575) | × TBA10017(E3\1.3\0\3575) |
| ▲ TBA10018(E3\1.3\0\3575)   |                             |                           |

Prototype\ Backfill \ Between dep.hole 3-4 (20010917-20220101)  
Temperature - Pentronic

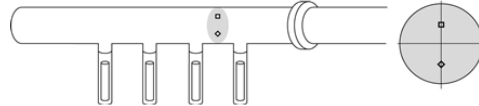
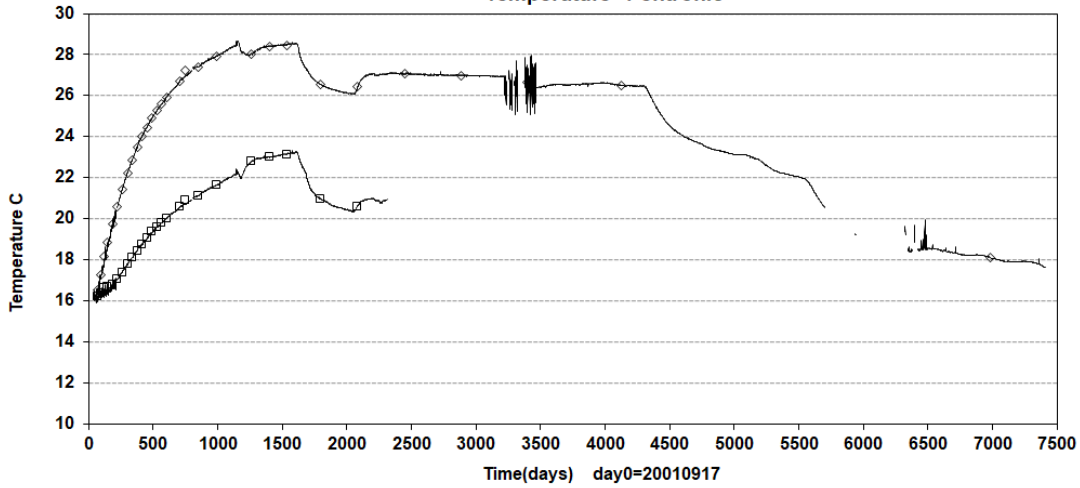

- |                             |                             |
|-----------------------------|-----------------------------|
| □ TBA10019(F3-4\0\1.2\3572) | ◇ TBA10020(F3-4\0\1.3\3572) |
|-----------------------------|-----------------------------|

## Appendix 5

### A5.1 Water pressure measurements in the rock mass

#### A5.1.1 Introduction

The hydraulic properties of the rock, geometry of tunnels and depositions holes, water pressure far away from the tunnels and the hydro-mechanical properties of the backfill and buffer govern the saturation of the buffer and backfill. It is important to measure the water pressure in the rock for the interpretation of the measurements in the buffer and backfill and to sample data useful for the modelling of the saturation process.

This appendix presents the still on-going (2021) measurements in Section I. Section II has been dismantled during 2011 and pressure measurements are no longer performed there. Latest report of measurements is presented in (Goudarzi 2022) and earlier measurements together with details for section II are presented in earlier annual reports.

#### A5.1.2 Measurements in the boreholes

A significant number of boreholes are instrumented with one or several packers. In all packed-off sections, the water pressure is measured. Each borehole section is connected to a tube of polyamide that via lead-through holes ends in the G-tunnel. All pressure transducers are placed in the G-tunnel to facilitate easy calibration and exchange of transducers that are out of order. The transducers are connected to the HMS system at Äspö Laboratory and it is a flexible system for changing the logging frequency. The maximum scan frequency is 1/second. During periods with no hydraulic tests, preliminary the logging (storing a value in the data base) frequency is 2/hour with an automatic increase of the sampling frequency if the pressure change since last registration is larger than 2kPa. During hydraulic tests, the sampling frequency is up to 1 logging every 3<sup>rd</sup> second (maximum logging rate possible).

All data now shown in plots are quality verified data from the SICADA database, which is a change from earlier reports before 2017 when data was collected from the HMS system itself.

#### A5.1.3 Instrumentation with bentonite packers in Section I

Section I will be in operation for a long time, possibly up to 20 years, and there will be no access to the instruments in the boreholes for a long period. It was decided to develop a new type of packer that was not dependent of an external pressure to seal-off the borehole sections. These packers are made of compacted bentonite with rubber coverage. For chemical reasons the bentonite is not allowed to be in contact with the surrounding water in the rock mass and therefore the packers have a cover made of polyurethane (PUR-rubber). This rubber also protected the packers against unwanted wetting during transport and installation. After installing all packers in a borehole, the compacted bentonite was wetted to make it swell and expanded against the borehole wall. This packer system is used in 14 boreholes with a length between 12 and 50 meters in the tunnel floor and the walls, see (Rhén et al. 2001).

Due to the expected high temperature near the deposition holes two boreholes (KA3574A and KA3576A) were equipped with stainless steel pipes instead of polyamide tubes.

In some sections used for circulation or hydrochemistry sampling purposes in Section I, a dummy is installed to reduce the water-filled volume of the section. Depending on the purpose the dummies were made either by high-density polyethylene (circulation sections) or PEEK (hydrochemistry sections) material. The dummy consists of two parts, positioned around the centre rod.

The packers were inserted into the borehole with Ø 20 mm massive stainless-steel rods. A special designed manual-hoisting rig was used to insert the equipment into the boreholes. When the packers were at their correct position the equipment was attached to a locking device mounted on the tunnel wall at the borehole collar. Before insertion, the equipment was cleaned with a cleaner delivering hot steam (100 °C) at high pressure.

The instrument configuration for the boreholes provided with bentonite packers is summarised in Table A5-1 and illustrated in Figures A5-1 and A5-2.

*Table A5-1. Instrumentation configuration in Section I. "Lead-through": pipes between the packers.*

<b>Borehole:sec</b>	<b>Sec. length (m)</b>	<b>Type of section</b>	<b>Type of dummy</b>	<b>Packer length</b>	<b>Lead-through (no:diameter:type)</b>
KA3563G:1	15 – 30.01	P		2 m	1:6/4:PA
KA3563G:2	10 – 13	P		2 m	2:6/4:PA
KA3563G:3	4 – 8	P		1 m	3:6/4:PA
KA3563G:4	1.5 – 3	P, C	HD	1 m	6:6/4:PA
KA3566G01:1	23.5 – 30.01	P		2 m	1:6/4:PA
KA3566G01:2	20 – 21.5	P, C	HD	2 m	4:6/4:PA
KA3566G01:3	12 – 18	P		2 m	5:6/4:PA
KA3566G01:4	7.3 – 10	P		1 m	6:6/4:PA
KA3566G01:5	1.5 – 6.3	P, F		1 m	8:6/4:PA
KA3566G02:1	19 – 30.1	P		1 m	1:6/4:PA
KA3566G02:2	16 – 18	P, C	HD	2 m	4:6/4:PA
KA3566G02:3	12 – 14	P		1 m	5:6/4:PA
KA3566G02:4	8 – 11	P		2 m	6:6/4:PA
KA3566G02:5	1.3 – 6	P, F		1 m	8:6/4:PA
KA3572G01:1	7.3 – 12.03	P		2 m	1:6/4:PA
KA3572G01:2	2.7 – 5.3	P, C	HD	2 m	4:6/4:PA
KA3573A:1	26 – 40.07	P		2 m	1:6/4:PA
KA3573A:2	21 – 24	P, F		2 m	3:6/4:PA
KA3573A:3	14.5 – 19	P		2 m	4:6/4:PA
KA3573A:4	10.5 – 12.5	P, F		2 m	6:6/4:PA
KA3573A:5	1.3 – 8.5	P		1 m	7:6/4:PA
KA3574G01:1	8 – 12.03	P		1 m	1:6/4:ST
KA3574G01:2	5.1 – 7	P		1 m	2:6/4:ST
KA3574G01:3	1.8 – 4.1	P, C	HD	1 m	5:6/4:ST
KA3576G01:1	8 – 12.01	P		2 m	1:6/4:ST
KA3576G01:2	4 – 6	P, HC	PE	1 m	2:6/4:ST, 1:1/8"/2:PE
KA3576G01:3	1.3 – 3	P		1 m	3:6/4:ST, 1:1/8"/2:PE
KA3578G01:1	6.5 – 12.58	P		1 m	1:6/4:PA
KA3578G01:2	4.3 – 5.5	P, HC	PE	2 m	2:6/4:PA, 1:1/8"/2:PE
KA3579G:1	14.7 – 22.65	P		1 m	1:6/4:PA
KA3579G:2	12.5 – 13.7	P		1 m	2:6/4:PA
KA3579G:3	2.3 – 11.5	P		2 m	3:6/4:PA
KA3584G01:1	7 – 12	P		2 m	1:6/4:PA
KA3584G01:2	1.3 – 5	P		1 m	2:6/4:PA
KA3590G01:1	16 – 30	P		1 m	1:6/4:PA
KA3590G01:2	7 – 15	P, F, F		1 m	4:6/4:PA
KA3590G01:3	1.3 – 6	P, HC		1 m	5:6/4:PA, 1:1/8"/2:PE
KA3590G02:1	25.5 – 30.01	P, F		2 m	2:6/4:PA
KA3590G02:2	15.2 – 23.5	P		2 m	3:6/4:PA
KA3590G02:3	11.9 – 13.2	P, HC	PE	2 m	4:6/4:PA, 1:1/8"/2:PE
KA3590G02:4	1.3 – 9.9	P		1 m	5:6/4:PA, 1:1/8"/2:PE
KA3593G:1	25.2 – 30.02	P		1 m	1:6/4:PA

Borehole:sec	Sec. length (m)	Type of section	Type of dummy	Packer length	Lead-through (no:diameter:type)
KA3593G:2	23.5 – 24.2	P, HC	PE	1 m	2:6/4:PA, 1:1/8"/2:PE
KA3593G:3	9 – 22.5	P		2 m	3:6/4:PA, 1:1/8"/2:PE
KA3593G:4	3 – 7	P, F		2 m	5:6/4:PA, 1:1/8"/2:PE
KA3600F:1	43 – 50.1	P		1 m	1:6/4:PA
KA3600F:2	40.5 – 42	P, HC	PE	1 m	2:6/4:PA, 1:1/8"/2:PE
KA3600F:3	20 – 39.5	P		2 m	3:6/4:PA, 1:1/8"/2:PE
KA3600F:4	1.3 – 18	P		1 m	4:6/4:PA, 1:1/8"/2:PE
KA3510A:1	125 – 150	P		1 m	1:6/4:PA
KA3510A:2	110 - 124	P, F		1 m	3:6/4:PA
KA3510A:3	75 - 109	P		1 m	4:6/4:PA
KA3510A:4	51 - 74	P		1 m	5:6/4:PA
KA3510A:5	4.5 - 50	P		1 m	6:6/4:PA
KG0021A01:1	42.5 – 48.82	P, HC		1 m	1:6/4:ST, 1:1/8"/2:PE
KG0021A01:2	37 – 41.5	P		1 m	2:6/4:PA, 1:1/8"/2:PE
KG0021A01:3	35 - 36	P, C	HD	1 m	5:6/4:PA, 1:1/8"/2:PE
KG0021A01:4	19 - 34	P		1 m	6:6/4:PA, 1:1/8"/2:PE
KG0021A01:5	5 - 18	P		1 m	7:6/4:PA, 1:1/8"/2:PE
KG0048A01:1	49 – 54.69	P, HC		1 m	1:6/4:ST, 1:1/8"/2:PE
KG0048A01:2	34.8 – 48	P		1 m	2:6/4:PA, 1:1/8"/2:PE
KG0048A01:3	32.8 – 33.8	P, C	HD	1 m	5:6/4:PA, 1:1/8"/2:PE
KG0048A01:4	13 – 31.8	P		1 m	6:6/4:PA, 1:1/8"/2:PE
KG0048A01:5	5 - 12	P		1 m	7:6/4:PA, 1:1/8"/2:PE

Type of section:

Materials:

P Pressure measurement PA  
Polyamide

C Circulation possible ST  
Steel

HC Hydrochemistry sampling PE  
PEEK

F Flow  
HD HD1000 (High Density Polyethylene)

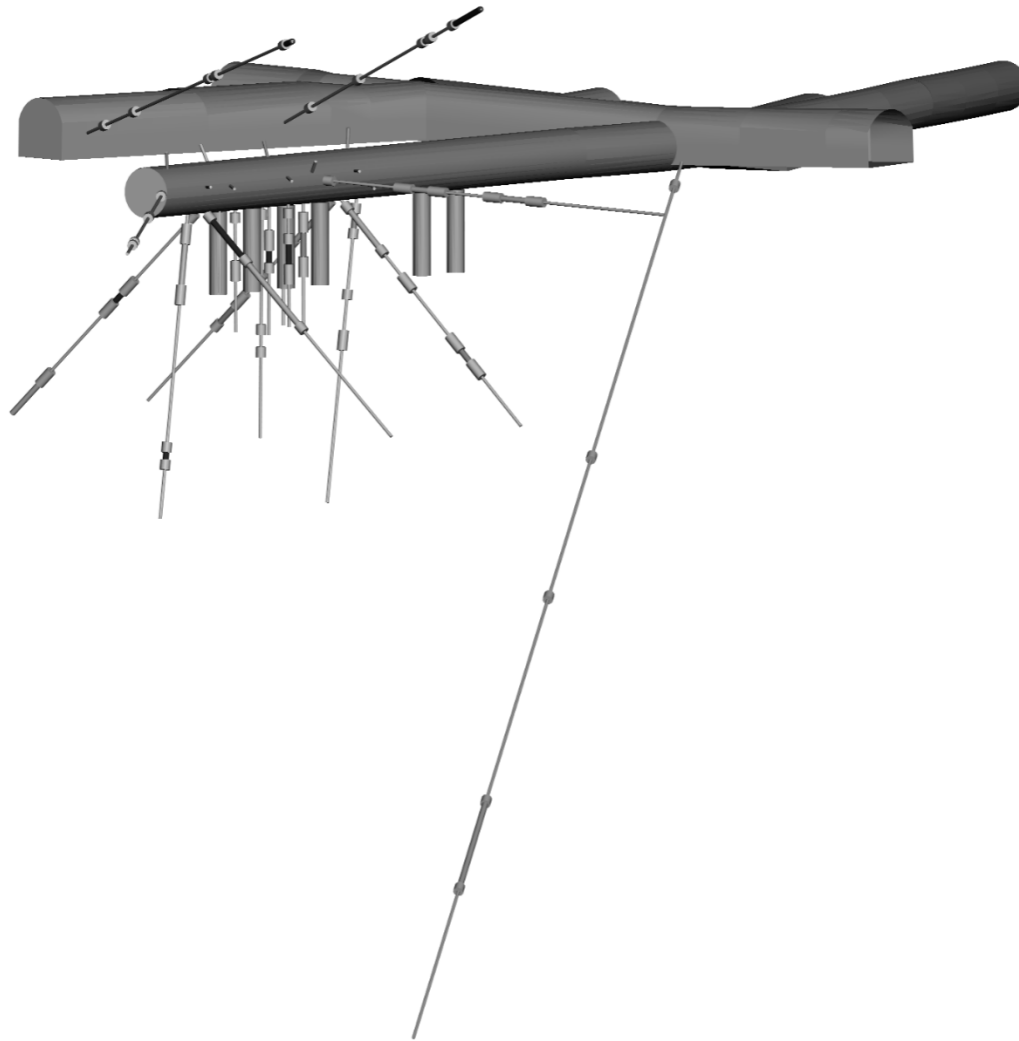

**Figure A5-0-1. View of the drilled core holes in the Prototype Repository Section I. The length from the I-tunnel to the end of the TBM-tunnel is 90 m. The diameter of the TBM tunnel is 5m and the diameter of the deposition holes is 1.75 m. The depth of the deposition holes is holes is 8.37 m in the centre and 8.15 m along the deposition hole wall. The diameter of the core holes is 76 mm except for the short core holes in the roof of the TBM tunnel that have a diameter of 56 mm. The monitoring boreholes used in the presentation in this report are located in the inner part of the tunnel surrounding the area with the four innermost canister holes. Also included are two holes drilled from the G-tunnel and the long hole KA3510A drilled from the main tunnel.**

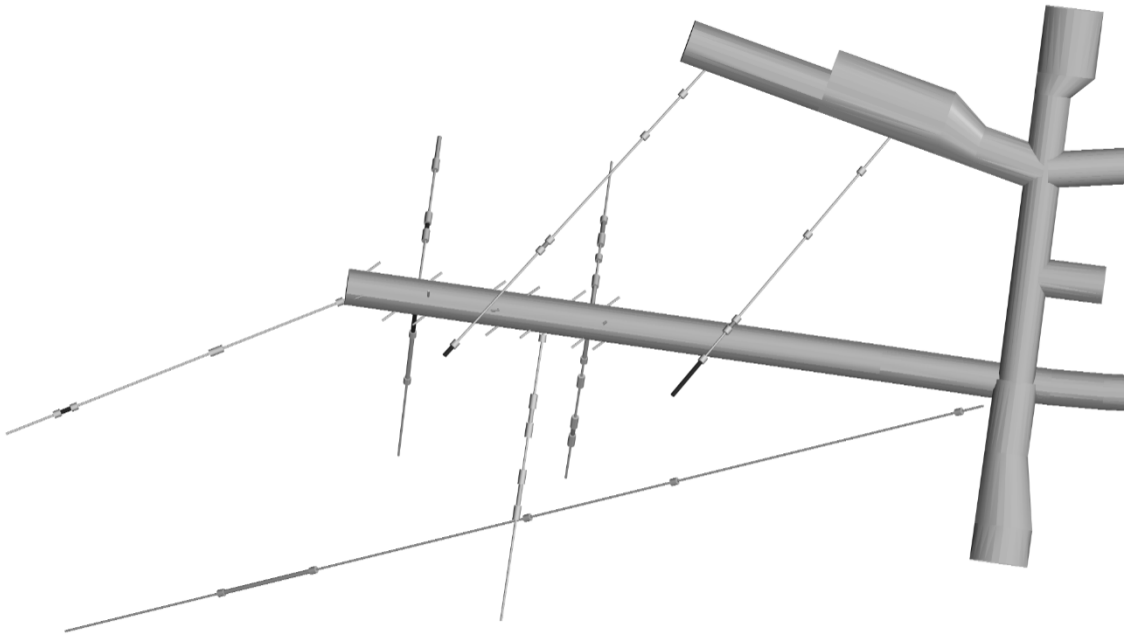

*Figure A5-0-2. Overview of Section I in Prototype Repository.*



#### A5.1.4 Instrumentation with mechanical packers

In Section 1 sixteen short boreholes (2 m) in the tunnel roof and walls are equipped with mechanical packers, see Table A5-2. After insertion into the hole, the pulling of a nut on the centre pipe expanded the packer. Since these holes are directed upwards, the de-aeration required an extra lead-through connected to a tube ending in the innermost part of the borehole. The de-aeration was made during the backfilling and in boreholes with very little flow the de-aeration was made by filling water through the outer tube.

*Table A5-2. Boreholes instrumented with mechanical packers (“Inclination”: inclination of the borehole).*

Borehole	Borehole length (m)	Inclination (°)
KA3563A01	2.06	-7.7
KA3563D01	approx. 2	2.8
KA3563I01	2.15	73
KA3566C01	2.1	3.5
KA3568D01	2.3	-2.3
KA3573C01	2.05	34.9
KA3574D01	2.05	12.6
KA3578C01	2.09	-5.4
KA3578H01	1.9	59.1
KA3579D01	2	-1
KA3588C01	2.04	-4
KA3588D01	1.9	-1.8
KA3588I01	1.96	65.6
KA3592C01	2.1	4.4
KA3597D01	2.22	3.1
KA3597H01	2.06	55.1

#### A5.1.5 Calibration intervals

Recalibration of pressure transducers are made a couple of times every year.

#### A5.1.6 Pressure measurements

In this section pressure measurement of all monitored holes in the Prototype repository is shown in plots below. The pressure values plotted are daily mean values. The definition of day 0 is the day the heating of canister 1 started, i.e. 2001-09-17.

In Table A5-3 the dates of the starting of the heaters in Section 1 are presented.

*Table A5-3. Heaters in canisters.*

Canister in deposition hole	Started	Stopped
1 (DA3587G)	2001-09-17	2019-12-17
2 (DA3581G)	2001-09-24	2004-12-01
3 (DA3575G)	2001-11-10	2015-10-07
4 (DA3569G)	2001-11-24	

The position of pressure measurement is indicated for all observation sections.

In the longer holes the section closest to the wall generally has a lower head than sections deeper into the rock mass.

A pressure drop 2002-05-07 for most of the observation sections are shown in the plots. The most major pressure change happens in the lowest section of KA3566G02 (approx. 70 m) but are also clearly visible for section 2-4 of the same borehole. The pressure recovered during the evening of 2002-12-02. The cause for the pressure change is unknown.

Several sections had a slight decreasing trend after the summer of 2002. This trend was in most cases discontinued after 2004-11-01 when the draining of Section I was closed down.

During the period 2003-05-08 until 2003-05-15 a total of 19 hydraulic tests (TC 1) were done in several of the boreholes in Section I and II. The tests caused groundwater pressure interference in the whole of the prototype repository area. Since the tests were mostly short-time tests it is only shown in some of the borehole section plots.

During the summer 2003 (2003-07-13 to 2003-08-05) no pressure data was recorded. In some of the long boreholes inclined to the south of the prototype show a pressure drop in mid-August.

Hydraulic single hole tests were done in nine boreholes during 2003-10-21 – 10-23 (TC 2). The tests caused groundwater pressure interference in the whole of the prototype repository area. Since the tests were mostly short-time tests it is only shown in some of the borehole section plots.

Hydraulic single hole tests were done in eight boreholes during 2004-02-02 – 02-04 (TC 3). The tests caused groundwater pressure interference in the whole of the prototype repository area. Since the tests were mostly short-time tests it is only shown in some of the borehole section plots.

A pressure drop of around 700 kPa in KA3566G01:4 is observed 2004-02-25. It remained so for some weeks before recovering but dropped again in May and remains that way at the end of the month. This pattern was also observed in this section during the spring 2003. The following investigation showed a faulty data-scan coupling (corrosion) which was replaced 2004-08-10.

Hydraulic single hole tests were done in eight boreholes during 2004-08-11 – 08-18 (TC 4). The tests caused groundwater pressure interference in the whole of the prototype repository area. Since the tests were mostly short-time tests it is only shown in some of the borehole section plots.

During the period 2005-01-19 until 2005-01-28 a total of 26 hydraulic tests (TC 5) were done in several of the boreholes in Section I and II. The tests caused groundwater pressure interference in the whole of the prototype repository area. Since the tests were mostly short-time tests it is only shown in some of the borehole section plots.

During week 36, starting 2005-09-05, several boreholes have a rather sudden drop in pressure which does not recover immediately. The reason is not known yet.

Hydraulic single hole tests were done in eight boreholes during 2005-11-28 – 12-02 (TC 6). A total of 17 tests were done. The tests caused groundwater pressure interference in the whole of the prototype repository area. Since the tests were mostly short-time tests it is only shown in some of the borehole section plots.

In KA3573A the pressure in section 3 suddenly decreases around 200 kPa 2006-02-12/13. This is the initial phase as it turned out later, see below, of the total pressure loss of that section.

In KA3566G01 sections 2 and 3, and 4 and 5 respectively are short-cut from 2006-03-03. The reason is not known.

A pressure drop in several borehole sections on the south side of the prototype repository is observed from approximately 2006-04-18. At the same time the drainage from Section 1 increases from 1.5 to 9 L/min. Section KA3573A:3 which lost most of its pressure head is believed to lead groundwater, together with sections KA3573A:2 & 4, into the Section 1 backfill. In earlier investigations, this borehole had flow rates over 50 L/min (Rhén and Forsmark 2001). The following borehole/sections are affected by this pressure drop event: KA3510A:3-5,

KA3566G01:1, KA3573A:2-4, KA3590G01:1-2, KG0021A01:1-4 and KG0048A01:1-4. The pressure decrease is probably a result of a leaking tube or a tube coupling from KA3573A:3. At the beginning of 2012 the pressure in KA3573A:3 was at the same level as the pressure in the backfill (around 500 kPa). During 2018 the pressure is approximately 2000 kPa.

Hydraulic single hole tests were done in eight boreholes during 2006-09-25 – 09-29 (TC 7). A total of 17 tests were done. The tests caused groundwater pressure interference in the whole of the prototype repository area. Since the tests were mostly short-time tests it is only shown in some of the borehole section plots.

In November/December 2006, dilution measurements were made KA3563G:4, KA3566G01:2, KA3566G02:2, KA3572G01:2, KA3574G01:3, KG0021A01:3 and KG0048A01:3.

The work with excavating a new tunnel niche from I-niche, for sealing experiments, commenced in March 2007. The project is called “Sealing of Tunnel at Great Depth”. Since it is situated rather close to the Prototype Repository it is expected to influence the pressure levels around the prototype.

During the period, March – December 2007, the drilling and testing of three boreholes in niche I, KI0010B01, KI0014B01 and KI0016B01 causes major pressure head fluctuations in most of the observation sections in the prototype repository. The overall groundwater head level decreases during this period but late in the period seems to recover. The new boreholes are drilled within the project “Sealing of Tunnel at Great Depth”.

The pressure transducers in KA3510A were taken out of operation 2007-08-20. The reason is the on-going tunnel construction works in the I-niche. They were taken in operation again in August 2008.

KA3566G02 transducers do not seem to work properly since the start of the “Sealing of Tunnel at Great Depth” project in the summer of 2007.

Hydraulic single hole tests were done in eight boreholes during 2007-10-15 – 10-19 (TC 8). A total of 17 tests were done. The tests caused some groundwater pressure interference in the prototype repository area.

The pressure in KA3574G01:2 suddenly start rising from 2008-08-30. The overall increasing trend continued until approximately 2016.

Hydraulic single hole tests were done in eight boreholes during 2008-10-20 – 10-24 (TC 9). A total of 17 tests were done.

Fan grouting was done in the project “Sealing of Tunnel at Great Depth” during several periods during the spring 2009.

There is a sudden pressure decrease in KA3510A:1 and KA3510A:2 2009-04-16 which last until 2009-05-07.

No pressure recordings are made in HMS between 2009-05-23 and 2009-06-11.

During the period 2009-11-09 until 2009-11-19 six interference-tests (TC 10) were done in boreholes KA3539G:2, KA3542G02:5, KA3554G01:2, KA3590G02:1, KG0021A01:3 and KG0048A01:3. Flowing periods were 6 hours for each of the boreholes.

Between 2008 and 2012 the general trend is a decrease in pressure.

Pressure increases occurs KA3588C01:1 and KA3588D01 during the months of January and February 2010. It decreases after a while. The reason is unknown.

Preparations for demolition of the outer plug, Section II, started at the end of November 2010. During 2010-11-23 and 2010-11-24 groundwater sampling is made from several boreholes within the prototype Section I and II. A pressure decrease is clearly seen in the plots for several of the observation sections in both sections.

Demolition work of the outer plug of Section II started during December 2010 and was finalized during February 2011. The work was done by drilling several boreholes into the concrete plug continued by mechanical impact with a hydraulic hammer and a hydraulic breaker. All demolition work in the tunnel section II was finalized by 2011-12-15.

The boreholes in Section I closest to the plug between Section I and II show an obvious pressure drop during 2011 due to the demolition of Section II. The pressure recovers during 2012.

The pressure recovery continued during 2013 and 2014.

A pressure drop occurs in the period close to 2013-11-01 in almost all the remaining borehole-sections of the Prototype Section I. The reason for this remains unknown so far.

In December 2014 work with replacing packers in multi-section borehole from Section II is done. The boreholes that have their packers replaced with a single mechanical packer are KA3539G, KA3542G01, KA3542G02, KA3548G01, KA3554G01, KA3554G02 and KA3557G. The pressure in most of the borehole sections in Section I responds with a very fast pressure increase shown in the pressure diagrams.

A larger pressure drop occurring in June 2016 was observed in KA3573A:1, KA3566G02:2, KA3590G01:1 and 2. The reason for this is so far unknown.

In the report for 2017 all figures in the appendix were replotted using quality verified data from the SICADA database between 2001-2017. No major changes occurred compared to the unverified data used in the appendix for previous years. Quality verified data from SICADA has been continuously used in all reports produced since 2017.

During 2015 - 2017 the pressure is stable but slowly declining in most of the boreholes in section I. Major exceptions from the general trend 2015 – 2017 are discussed below.

During 2015 - 2017 an increasing trend in pressure have been distinguished in bottom sections of several boreholes oriented downwards and located in the western part of tunnel A. More specifically the pressure increase has been observed in KA3574G01:1, KA3593G:1, KA3579G:3 and KA3578G01:1 as seen in the pressure diagrams. The increase is also observed in the bottom section of KA3573A, however this borehole is oriented horizontally. The cause if this increase is not known but might be due to blockage in water-bearing fractures.

The 14<sup>th</sup> of March 2017 a sudden decrease in pressure is observed in KA3572G01:1, KA3576G01:3 and KA3578G01:2. The magnitude of the disturbance is ~250 kPa in KA3572G01:1 and KA3576G01:3 while in KA3578G01:2 it is ~1000 kPa. What caused the decline is yet not known.

The pressure in both KA3600F:1 and 2 drops within a repeated pattern and has done so since 2002. The larger declines have a magnitude of ~3000 kPa in section 2. The larger drops in both section 1 and 2 occurs with a cycle of approximately 6 months (usually once in April and once in September each year) and are due to regular groundwater sampling. The explanation for pressure drops occurring neither in April or September are however not known.

The pressure in KA3563:2 starts to decrease in the end of 2016 and continues the falling trend until mid-2017. Then the pressure is beginning to rise slowly again, and the increase is ongoing throughout 2018.

The overall trend with stable pressure levels that are slowly declining in section I is still ongoing throughout 2018. The increasing trend seen 2017 in several boreholes in the western part of tunnel A (KA3574G01:1, KA3576G01:3, KA3578G01:1, KA3579G:3, KA3593G:1) has started to level out during 2018 and some of the boreholes has even started to show a slow decrease again.

Most of the borehole sections do not show any sudden changes during 2018 but there are four exceptions:

KA3573A:1. Shows an oscillating trend since 2017 when it recovered from a major pressure drop. The reason for this trend is unknown. Section 4 in the same borehole had problem with loose connection during 2017 and 2018.

KA3584G01:1. Shows two stepwise decreases in pressure during 2018. The first one includes a drop of approximately 260 kPa and it occurs between 2018-01-31 and 2018-04-24. This coincide with the time period when rock reinforcement was conducted in the G-tunnel (including drilling of approximately 2,5 m long holes). However, no certain conclusions have been able to make if this could be the cause of the pressure drop. The second decline in pressure included a total loss of 400 kPa and it occurred between 2018-10-26 and 2018-12-31. The weir was damaged by a falling boulder the 22th of October which caused the pressure to drop. The weir was restored again the 6<sup>th</sup> of December 2018.

KG0021A01:5 and KG0048A01:5 (two longer bore holes drilled from the G tunnel towards the A tunnel). Both sections show a decrease in pressure the 12th of February 2018. Each section decrease approximately 200 kPa in 7 days. No recovery is seen during the rest of 2018. The exact reason for this is still not known. However, during this period rock reinforcements were made in the G-tunnel (as mentioned above) which might have affected KG0021A01:5 and KG0048A01:5 that are located furthest in towards the G tunnel.

Throughout 2019 the pressure head in most boreholes is still slowly declining or levelling out. Besides this, two events occur in almost all boreholes during June and May. In June there is a 1-2 days long increase of maximum ~600 kPa and just as suddenly there is a decrease in July for maximum ~600 kPa. Most boreholes are recovered within a few days from each event. The sudden changes are seen in almost all boreholes in Section 1, however more or less distinct and not always in all sections of the borehole. Sections furthest away from the tunnel seems to be less affected compared to the ones closer to the tunnel. Both the increase and decrease affect boreholes in tunnel A and G. The sudden changes (occurring in May and July) correspond well with the dates for deactivating and reactivating KA3510A (see comment further down). No other explanation has been found in the activity logs for tunnel A, F, G, I, J and S or in the quality comments.

It should also be mentioned that during 2019 there have been a period were missing data or certain erroneous data could exist due to error in data communication. This applies to KA3563A01, KA3563D01 and KA3563I01 during 2019-07-24 – 2019-11-08.

During 2019 there are also a few exceptions from the general behaviour which is discussed below:

KA3510A. The pressure weirs in all sections (1-5) were disconnected and the sections were deactivated between the beginning of May until the beginning of July. When they were activated again section 1, 4 and 5 shows a pressure decrease compared to before the deactivating (3000 kPa in section 1, 1500 kPa in section 4 and 400 kPa in section 5). Section 5 recovers within days meanwhile section 4 recovers within 2 months and section 1 recovers throughout the year. The deactivating and reactivating might be the explanation for the sudden increase and decrease in pressure head seen in most of the boreholes in section 1 in July and May 2019.

KA3573A:1<sup>1</sup>. As mentioned before, section 1 in KA3573A shows an oscillating trend since 2017 when it recovered from a major pressure drop. The trend continued during 2019.

KA3584G01:1. After two stepwise decreases 2018 this section showed an increasing trend throughout 2019.

---

<sup>1</sup> Incorrect specified as section 5 in the report from 2021. Correct section is number 1.

KA3600F. Section 1, 2 and 3 show sudden pressure drop in that cannot be explained with the usual chemical water sampling that is performed in the bore hole (see table in section *Water sampling*). The reason is not known.

During 2020 the pressure head in most boreholes is still slowly declining or levelling out. Overall, the pressure data shows no signs of significant disturbances. Four boreholes had problems with loose cables during 2020: KA3572G01:2, KA3573A:2, KG00048A01:3 and KA3572G01:2. The error exist between 1 – 6 days depending on which borehole. Erroneous data has been deleted. A few boreholes distinguish from the rest during 2020. The boreholes are in the middle or outer part of tunnel A and it is only the section located farthest away from the tunnel that shows anomalies (however during different periods of time for the different boreholes). The exceptions are discussed below:

KA3573A:1. Oriented horizontally compared with tunnel A. As mentioned before the section shows an oscillating trend since 2017 when it recovered from a major pressure drop. The trend continued during 2020. The pressure shows the same pattern every year since 2017: the pressure drops in the autumn (October-November) and start rising again in spring (April-June). The reason is not known.

KA3574G01:1. Oriented vertically compared with tunnel A. The section shows a sudden drop in pressure 2020-06-25. The pressure decreases ~210 kPa throughout two days. The recovery takes until September the same year. The reason is not to be found in the activity logs or quality comments.

KA3584G01:1. Oriented vertically compared with tunnel A. The section showed two stepwise decreases 2018 and was increasing again 2019. However, the section had a falling pressure head during the last days of 2019 until March 2020 (2019-12-28 until approximately 2020-04-03). The decrease continued for approximately three months and was of a magnitude of ~190 kPa. The reason is not to be found in the activity logs or quality comments.

During 2021 the pressure head in most boreholes is still slowly declining or levelling out. Overall, the pressure data shows no signs of significant disturbances. Exceptions are listed below. In which case the borehole has several sections, the anomaly is only seen in the section located farthest away from the tunnel. The reasons for the anomalies have not been found in the activity log for tunnel A or in the quality comments for 2021.

KA3563A01:1. Shows an overall decreasing trend in pressure since a mayor pressure increase in 2015. However, during 2021 the section is one of the few that shows an increase in pressure for a couple of months. The increase in pressure is relatively small (approximately 250 kPa) and occurs temporary. Compared to other boreholes/sections KA3563A01:1 and KA3563A01:2 shows a greater variation in pressure. However, both sections follow the same overall trend as for most of the other boreholes since 2015.

KA3573A:1. Oriented horizontally compared with tunnel A. As mentioned before the section shows an oscillating trend since 2017 when it recovered from a major pressure drop. The trend continued during 2021. The pressure decreases during autumn, reached its lowest in summer and then start rising again until next autumn when it decreases again. The rest of the sections (2 - 5) shows a stable or decreasing pressure. The variation might be due to fractures intersecting the test section are connected to a system of fractures up to surface. Indicating yearly variation in water levels. The yearly variation was not seen before 2015.

KA3574G01:1. Oriented vertically compared with tunnel A. The section showed a sudden drop in pressure 2020-06-25. After that the section shows a gentle oscillating trend following the same pattern as KA3573A:1 above. The pressure decreases during autumn, reached its lowest in summer and then start rising again until next autumn when it decreases again. The rest of the sections (2 and 3) shows a stable or decreasing pressure.

KA3576G01:1. Oriented vertically compared with tunnel A. Shows an increasing trend in pressure during 2021 (approximately 50 kPa). It is possible that the increase has been ongoing since 2019/2020 (however very slowly), but it is not until 2021 it is clearly seen in the graphs. The rest of the sections (2 and 3) shows a stable or decreasing pressure.

KA3584G01:1. Oriented horizontally compared with tunnel A. The section had two stepwise decreases during 2018 and one in 2019. Since then and throughout 2021 the pressure is increasing (which is the opposite compared to the overall trend with decreasing or stable pressure 2021). The other section (section 2) shows a decrease in pressure.

KA3593G:1. Oriented vertically compared with tunnel A. Showed an increasing trend in pressure during 2015-2017. During 2020 and 2021 the section shows a gentle oscillation trend following the same pattern as KA3573A:1 and KA3574G01:1. The pressure decreases during autumn, reached its lowest in summer and then start rising again until next autumn when it decreases again. The rest of the sections (2 and 3) shows a decrease in pressure.

Six boreholes had problems with loose cables during 2021: KA3566C01:1, KA3566G02:4, KA3568D01:1, KA3573A:4, KA3590G01:1 and KG0048A01:3. The error exist between 2 – 27 days depending on which borehole. Erroneous data has been deleted.

In Table A5-4 the pressure sensor status 2022-01-01 is estimated based on pressure head data.

*Table A5-4. Apparent pressure sensor status.*

Borehole:sec	Secup (m)	Seclow (m)	Pressure status 2021-01-01	Comment
KA3510A:1	125.00	150.00	OK	
KA3510A:2	110.00	124.00	OK	
KA3510A:3	75.00	109.00	OK	
KA3510A:4	51.00	74.00	OK	Pressure very low since June 2010. Leakage causing low pressure, repaired May 2015.
KA3510A:5	4.50	50.00	OK	
KA3563A01:1	0.65	2.06	OK	
KA3563D01:1	0.65	2.01	OK	
KA3563G:1	15.00	30.01	OK	
KA3563G:2	10.00	13.00	OK	
KA3563G:3	4.00	8.00	OK	Shortcut?
KA3563G:4	1.50	3.00	OK	Shortcut?
KA3563I01:1	0.65	2.15	OK	
KA3566C01:1	0.65	2.1	OK	
KA3566G01:1	23.50	30.01	OK	
KA3566G01:2	20.00	21.50	OK	
KA3566G01:3	12.00	18.00	OK	

Borehole:sec	Secup (m)	Seclow (m)	Pressure status 2021-01-01	Comment
KA3566G01:4	7.30	10.00	Not OK	Shortcut between sections 4 and 5 from 2006
KA3566G01:5	1.50	6.30	Not OK	Shortcut between sections 4 and 5 from 2006
KA3566G02:1	19.00	30.10	Not OK	Pressure drop May 2007. All sections shortcut! Sudden increase 2015.
KA3566G02:2	16.00	18.00	Not OK	Pressure drop May 2007. All sections shortcut! Sudden increase 2015.
KA3566G02:3	12.00	14.00	Not OK	Pressure drop May 2007. All sections shortcut! Sudden increase 2015.
KA3566G02:4	8.00	11.00	Not OK	Pressure drop May 2007. All sections shortcut! Sudden increase 2015.
KA3566G02:5	1.30	6.00	Not OK	Pressure drop May 2007. All sections shortcut! Sudden increase 2015.
KA3568D01:1	0.65	2.30	OK	
KA3572G01:1	7.30	12.03	OK	
KA3572G01:2	2.70	5.30	OK	
KA3573A:1	26.00	40.07	Not OK?	Probable tube failure in section 3
KA3573A:2	21.00	24.00	Not OK	Probable tube failure in section 3. Shortcut?
KA3573A:3	14.50	19.00	Not OK	Probable tube or tube coupling failure. Shortcut?
KA3573A:4	10.50	12.50	Not OK	Probable tube failure in section 3. Shortcut?
KA3573A:5	1.30	8.50	Not OK	Probable tube failure in section 3. Shortcut?
KA3573C01:1	0.65	2.05	OK	
KA3574D01:1	0.65	2.05	OK	
KA3574G01:1	8.00	12.03	OK	
KA3574G01:2	5.10	7.00	OK?	Sudden pressure increase 2008-08-30. Uncertain if OK afterwards. However, pressure may be correct after the sudden increase.
KA3574G01:3	1.80	4.10	OK	
KA3576G01:1	8.00	12.01	OK	
KA3576G01:2	4.00	6.00	Not OK?	Pressure decrease starting Jan. 2009
KA3576G01:3	1.30	3.00	OK	
KA3578C01:1	0.65	2.09	OK	
KA3578G01:1	6.50	12.58	OK?	Shortcut between sections in 2013? Change order at 2013: before section 1 has highest pressure but afterwards section 2 is highest. OK?
KA3578G01:2	4.30	5.50	OK?	Shortcut between sections in 2013? Change order at 2013: before section 1 has highest pressure but afterwards section 2 is highest. OK?
KA3578H01:1	0.65	1.90	OK	
KA3579D01:1	0.65	2.00	Not OK?	Air in borehole section?
KA3579G:1	14.70	22.65	OK?	Shortcut between sections
KA3579G:2	12.50	13.70	OK?	Shortcut between sections
KA3579G:3	2.30	11.50	Not OK	Air in borehole section?
KA3584G01:1	7.00	12.00	OK	
KA3584G01:2	1.30	5.00	OK	
KA3588C01:1	0.65	2.04	OK	



Borehole:sec	Secup (m)	Seclow (m)	Pressure status 2021-01-01	Comment
KA3588D01:1	0.65	1.90	Not OK	Not in operation any longer?
KA3588I01:1	0.65	1.96	OK	
KA3590G01:1	16.00	30.00	Not OK?	Shortcut between sections.
KA3590G01:2	7.00	15.00	Not OK?	Shortcut between sections.
KA3590G01:3	1.30	6.00	OK	
KA3590G02:1	25.50	30.01	OK	
KA3590G02:2	15.20	23.50	OK	
KA3590G02:3	11.90	13.20	OK	
KA3590G02:4	1.30	9.90	OK	
KA3592C01:1	0.65	2.01	Not OK?	Air in borehole section?
KA3593G:1	25.20	30.02	OK?	Very low pressure in section before 2016 and pressure was considered uncertain. After 2016 pressure is slowly increasing to the levels of the others sections. Leakage between section G:1 and G:2?
KA3593G:2	23.50	24.20	OK	
KA3593G:3	9.00	22.50	OK	
KA3593G:4	3.00	7.00	OK	
KA3597D01:1	0.65	2.22	Not OK?	Air in borehole section?
KA3597H01:1	0.65	2.06	OK	
KA3600F:1	43.00	50.10	OK	
KA3600F:2	40.50	42.00	OK	
KA3600F:3	20.00	39.50	OK	
KA3600F:4	1.30	18.00	OK	
KG0021A01:1	42.50	48.82	OK	
KG0021A01:2	37.00	41.50	OK	
KG0021A01:3	35.00	36.00	OK	
KG0021A01:4	19.00	34.00	OK	
KG0021A01:5	5.00	18.00	OK	
KG0048A01:1	49.00	54.69	OK	
KG0048A01:2	34.8	48	OK	
KG0048A01:3	32.80	33.80	OK	
KG0048A01:4	13.00	31.80	OK	
KG0048A01:5	5.00	12.00	OK	

### A5.1.7 Drainage of Section I

The drainage system in Section I was shutdown 2004-11-01. It resulted in a major pressure increase in most borehole sections close to the prototype tunnel. The pressure increased until 2004-12-06. The drained water amount was approximately 2.5 L/min. The flow rate of weir MG0004G decreased accordingly with the same order of magnitude after 2004-11-01.

The drainage system was re-opened 2004-12-06 due to electrical problems with the canister heaters. It is still open (2022-01-01). The pressure in most borehole sections within Section I decreased rapidly again after the re-opening.

In mid-April 2006 the flow rate from Section I rather suddenly increase to 9 L/min, while pressure decreases in several boreholes on the south side of the prototype. This is a result of tube failure in borehole section KA3573A:3.

The flow rate from Section I was still around 9 L/min at the end of 2010.

The flow during the period 2010–2014 decreases through weir MG0004G. This can be observed in the flow diagrams below. A measurement made 2015-05-06 shows a drainage flow of 0.16 L/min which is considerably lower than earlier. The flow through MG0004G is low during the entire 2015 and continues to be smaller than 4 L/min (2019).

During the years 2004 – 2014 a general pressure increase is observed in several boreholes. This might be due to that the inner section is slowly being water saturated. This phenomenon is seen especially in shorter boreholes in the ceiling of the tunnel in the inner section (for example KA3578C01, KA3578H01 and KA3579D01).

#### **A5.1.8 Flow measurements**

Earlier estimations and measurements of in-leaking ground water amounts to the tunnel system are presented in (Forsmark and Rhén 2001) and (Rhén and Forsmark 2001).

Data from twelve flow weirs are presented in this data report, out of which seven is currently (2021) in operation.

A weir at the tunnel G opening measures the leaking-in amounts from this tunnel. The weir was taken in operation in January 2002-01-21 and is named MG0004G. The water from MG0004G is led to PG5. The pumped water amounts from Section I mentioned above was prior to November 1, 2004, when the drainage of Section I was closed down, included in the rates from this weir station which is clearly shown in the diagram below. The packer or tube failure of KA3573A:3 2006-04-18 resulted in an increase of water being drained from Section 1 due to the fact that groundwater in the rock got contact with the backfill in section 1 via the borehole. Until the beginning of 2006 the trend was decreasing. The weir has been replaced with a new one in November 2014 and flow measurements will commence during 2015.

The weir MF0061G halfway down tunnel F measures today the in-leaking amounts from the first half of tunnel F, see plot of this weir. Earlier, until autumn 2001, in-leaking water from tunnel G was led to tunnel F and weir MF0061G thereby to some extent explaining the high flow rate during that period. The in-leaking water in tunnel J+ is included in the flow rate of MF0061G.

The weir MA3426G measures the flow rates from the south part of tunnel J and tunnel at chainage 3426 – 3514 m. Until December 2003 the in-leaking amounts from tunnel section 3515 – 3600 was included in the presented flow rate. The in-leaking water in tunnel I is included in this weir's flow rate.

In December 2003 three new flow measurement weirs were constructed in the A-tunnel outside Section II plug. They are called MA3515G, MA3525G and MA3535G (in operation 2003-12-10). The water from these three weirs is led to MA3426G. Continuous measurement is done since the spring of 2004. Manual measurements done in December 2003 show a flow rate for MA3515G of 0.175 – 0.19 L/min, for MA3525G of 1.15 – 1.25 L/min and for MA3535G of 0.38 – 0.45 L/min. The increase of flow during October 2004 was caused by yet unknown causes, but it is believed that the final grouting that was done around Plug 2 October 8, 2004 is the cause to it. The flow rates have since then decreased again.

The automatic registration of flow in MA3515G, MA3525G and MA3535G were cancelled during autumn 2007 due to the on-going tunnel construction work in the I-niche. The registration was resumed in April 2008 and continued until November 2010 when preparation started for the demolishing work of Prototype Section II.

Two weirs have, during the winter 2004/2005, been constructed inside niches I and J+. They are called MI0008G (in operation 2005-01-20) and MJ0033G (in operation 2005-01-20) respectively. The water from MI0008G is led to MA3426G. The water from MJ0033G is led to MF0061G. MI0008G is included in the continuously measurement program (HMS) while MJ0033G is measured manually approximately every fortnight. The readings from MI0008G have however not been correct since August 2005 and therefore no readings are presented since then. Manual readings were made 2006 and 2007. Manual reading 2006-06-26 shows a flow of 2.85 L/min which is within the same order of magnitude as the flow readings of the pre-August 2005 period.

MI0008G was plugged 2007-08-02 during the preparations of the construction of Tunnel S which will start inside niche I and the water is led to MA3426G.

No measurement of the flow into the A-tunnel from the intersection with tunnel I-J and the inner prototype plug is made today (2021). An attempt to construct a measurement weir 4–7 meters from the plug was made a couple of years ago (2012?) but the flow was very low and was not possible to quantify with the methodology available.

The flow rate in MA3426G has been extremely high during the period June until November 2007. This is due to that in-leaking water from the new boreholes KI0010B01 and KI0016B01 together with the water previously measured in MI0008G is led to MA3426G. A single rate measurement 2007-10-18 gives a flow rate from KI0010B01 of 44 L/min and from KI0016B01 of 7 L/min.

The pre-investigations for TASS resulted in major in-leaking amounts through the three long core holes drilled in the planned direction of TASS. During this period the in-leaking accumulated initial flow rates from the three boreholes was approximately 230 L/min, but the overall flow rate during the period until they were grouted was approximately 65 L/min which is the increase of flow in weir MA3426G where the water was directed.

There are three weirs where data is missing for shorter periods in the beginning of 2018. For two of them (MS0010G01 and MS0033G01) data is missing between 2018-01-01 and 2018-03-20 which is seen in the flow diagrams. The data for this period has not been approved by HMS and therefor the data has not been reported to the SICADA database. The loggers were reported to have a bad function during parts of the period. The third weir (MS0050G01) is lacking data only for a very short period (between 2018-03-15 and 2018-03-19) when the logger where reported broken. A few days before the flow decreased with 0,2 L/min which is possible to detect since the flow is relatively stable otherwise. The flow does not recover during the rest of 2018.

There are two weirs that show a sudden change in flow during February 2018: MF0061G and MG0004G which are two weirs located in the F-tunnel and G-tunnel. Three days apart from each other (2018-02-11 and 2018-02-14) the flow decreases with approximately 2-3 L/min in MF0061G and increases with approximately 1 L/min in MG0004G. The flows do not recover for the rest of 2018. The decrees in flow coincide with the time period when rock reinforcement was conducted in the G-tunnel (the same happening that is thought to have affected the pressure in KG0021A01:5 and KG0048A01:5 during February 2018).

During 2019 most weirs continue to have an overall stable long-term trend. The exceptions are MA3411G that throughout 2019 continues with its general decreasing trend and MS0033G01 that continues its decreasing tendency. However, there are a few moments during 2019 that should be commented on:

MA3515G shows an increase in flow during 1-2 days in the beginning of June and May. This coincide with the happening of pressure weir KA3510A being deactivated and reactivated again.

MS0010G01 and MS0033G01 are missing data between 26<sup>th</sup> of Mars and 5<sup>th</sup> of November. For the same time of period the weir was assumed to have been overflown

MS0050G01 shows a sudden increase of additionally 0,15 L/min during the beginning of October. The same weir showed a decrease of similar magnitude 2018. The flow stays at the higher rate for the rest of 2019. A cleansing of the weir was performed approximately 1.5 week before the event which might have increased the capacity afterwards.

Overall, the flow data shows no signs of significant disturbances during 2020. Throughout 2020 the weirs continue their stable long-term trend of flow measurements. The two weirs that were the exceptions during 2019 also seems to level out during 2020 (MA3411G and MS0033G01). For a short period of time MS0033G01 and MS0010G01 are overflown (2020-08-28 – 2020-09-

13). The data has been retained and certain erroneous data (though minor errors) can exist for shorter periods.

The stable trend in flow continues throughout 2021. The exception is MS0033G01 that continues its decreasing tendency. There are also a few moments during 2021 that should be commented on:

MS0010G01 and MS0033G01 are missing data between 2021-07-02 and 2021-09-07. This has happened before when the weirs have been assumed to be overflowed. However, no comment has been found in the activity log for tunnel A or in the quality comments for 2021.

MF0061G shows a sudden and temporary increase in flow 2021-11-16. Compare with the day before and after the flow increases with approximately 3 l/min. The reason is not to be found in the activity log for tunnel F or in the quality comments for 2021.

Three weirs are located within the TASS-tunnel and their locations are shown in Figure A5-3 below, measuring the flow into sections 10–33 m, 33–50 m and 50–80.7 m respectively.

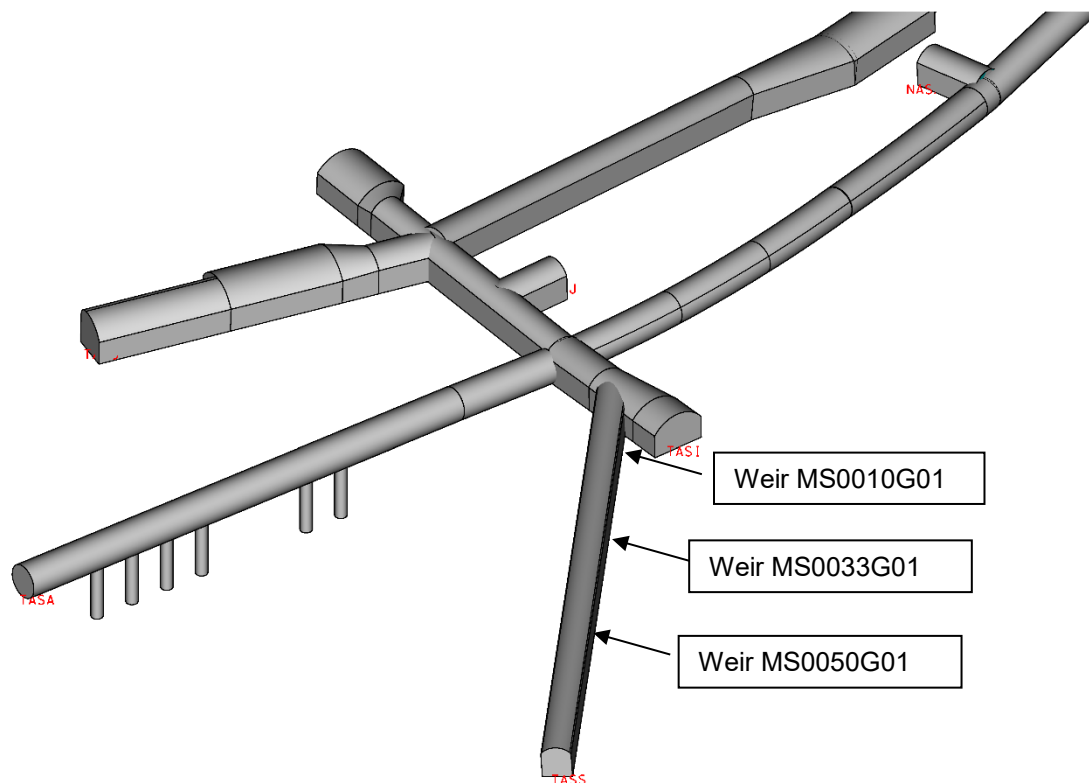

*Figure A5-0-3 The tunnel-system including the TASS-tunnel with indication of the weir locations in TASS.*

### **A5.1.9 Water sampling**

Water sampling for chemical analysis have been done at several occasions, see Table A5-5. Each one of them may have a short-lived effect on the hydrostatic pressure in the rock mass. In some cases the flowing of a section continued for several days and the following pressure response is clearly shown in the subsequent plots.

Water sampling for chemical analysis was ended during 2020.

*Table A5-5. Water sampling dates in boreholes close to the Prototype Repository. Start and stop of times are for the flowing of the section.*

<b>Borehole</b>	<b>Start date/time</b>	<b>Stop date/time</b>	<b>Secup</b>	<b>Seclow</b>	<b>Section number</b>
KA3600F	2001-10-15 10:30:00	2001-10-15 10:45:00	40.50	42.00	2
KA3600F	2001-10-15 10:45:00	2001-10-15 11:15:00	43.00	50.10	1
KA3573A	2002-09-24 10:30:00	2002-09-24 11:00:00	26.00	40.07	1
KA3573A	2002-09-24 11:40:00	2002-09-24 13:40:00	21.00	24.00	2
KA3600F	2002-09-25 SA2600A 11:00:00	2002-09-25 13:40:00	40.50	42.00	2
KA3600F	2002-09-25 11:25:00	2002-09-25 11:44:00	43.00	50.01	1
KA3510A	2002-12-12 08:30:00	2002-12-12 08:50:00	4.50	50.00	5
KA3510A	2002-12-12 08:30:00	2002-12-12 08:52:00	110.00	124.00	2
KA3510A	2002-12-12 10:30:00	2002-12-12 11:04:00	75.00	109.00	3
KG0048A01	2003-06-03 10:06:00	2003-06-03 10:12:00	32.80	33.80	3
KA3566G02	2003-06-04 12:30:00	2003-06-04 17:30:00	16.00	18.00	2
KG0021A01	2003-06-30 11:03:00	2003-06-30 11:09:00	35.00	36.00	3
KA3600F	2003-07-03 13:51:00	2003-07-03 13:53:00	40.50	42.00	2
KA3572G01	2003-08-11 15:28:00	2003-08-28 15:00:00	2.70	5.30	2
KG0021A01	2003-09-18 09:40:00	2003-09-18 09:55:00	35.00	36.00	3
KG0048A01	2003-09-18 09:45:00	2003-09-18 09:55:00	32.80	33.80	3
KA3573A	2003-09-25 09:00:00	2003-09-25 10:00:00	26.00	40.07	1
KA3600F	2003-09-25 09:00:00	2003-09-25 09:45:00	43.00	50.10	1
KA3600F	2003-09-25 09:30:00	2003-09-25 10:00:00	40.50	42.00	2
KA3573A	2003-09-29 10:20:00	2003-09-29 10:40:00	21.00	24.00	2
KA3566G02	2003-09-29 11:00:00	2003-09-29 13:50:00	16.00	18.00	2
KA3590G01	2003-09-30 09:00:00	2003-09-30 12:45:00	16.00	30.00	2
KA3600F	2004-02-17 09:55:00	2004-02-17 10:11:00	40.50	42.00	2
KG0021A01	2004-02-17 10:27:00	2004-02-17 10:43:00	35.00	36.00	3
KG0048A01	2004-03-02 09:24:00	2004-03-02 09:40:00	32.80	33.80	3
KA3590G01	2004-03-03 21:36:00	2004-03-03 21:36:00	7.00	15.00	2
KA3572G01	2004-04-02 10:35:00	2004-04-07 10:15:00	2.70	5.30	2
KA3573A	2004-09-21 09:23:00	2004-09-22 09:54:00	26.00	40.07	1
KA3600F	2004-09-21 09:23:00	2004-09-22 10:03:00	43.00	50.10	1
KA3573A	2004-09-22 09:2200	2004-09-22 10:03:00	21.00	24.00	2
KA3600F	2004-09-22 09:18:00	2004-09-22 09:44:00	40.50	42.00	2
KA3590G01	2004-11-15 11:16:00	2005-01-20 09:40:00	7.00	15.00	2
KA3566G02	2004-11-19 08:30:00	2004-11-22 09:53:00	16.00	18.00	2
KA3566G02	2005-02-03 10:20	2005-03-10 14:00	16.00	18.00	2
KA3573A	2005-09-26 10:5800	2005-09-26 10:58:00	21.00	24.00	2
KA3600F	2005-09-26 10:42:00	2005-09-26 10:42:00	40.50	42.00	2
KA3510A	2005-10-03 09:24:00	2005-10-03 09:29:00	110.00	124.00	2
KA3573A	2005-10-05 10:30:00	2005-10-05 11:05:00	26.00	40.07	1
KA3600F	2005-10-07 09:20:00	2005-10-07 10:03:00	43.00	50.10	1
KA3510A	2005-10-07 12:15:00	2005-10-07 12:38:00	110.00	124.00	2
KA3600F	2006-07-12 09:37:00	2006-07-12 10:04:00	40.50	42.00	2
KA3572G01	2006-07-12 10:00:00	2006-07-18 15:35:00	2.70	5.30	2

Borehole	Start date/time	Stop date/time	Secup	Seclow	Section number
KG0021A01	2006-07-12 13:40:00	2006-07-12 14:29:00	35.00	36.00	3
KG0048A01	2006-07-12 14:42:00	2006-07-12 15:36:00	32.80	33.80	3
KA3590G01	2006-07-13 09:55:00	2006-07-13 16:00:00	7.00	15.00	2
KA3566G02	2006-07-13 10:10:00	2006-07-13 19:25:00	16.00	18.00	2
KA3510A	2006-09-20 08:30:00	2006-09-20 08:35:00			No section data avail.
KA3573A	2006-10-02 10:15:00	2006-10-02 10:37:00	21.00	24.00	2
KA3600F	2006-10-02 09:50:00	2006-10-02 10:10:00	40.50	42.00	2
KA3573A	2006-10-03 09:50:00	2006-10-03 10:17:00	26.00	40.07	1
KA3600F	2006-10-03 09:50:00	2006-10-03 10:13:00	43.00	51.10	1
KA3600F	2007-01-09 14:32:00	2007-01-09 14:58:00			No section data avail.
KA3572G01	2007-01-10 09:30:00	2007-01-16 10:33:00			No section data avail.
KA3566G02	2007-01-11 08:57:00	2007-01-11 16:35:00			No section data avail.
KA3590G01	2007-01-15 09:07:00	2007-01-15 14:37:00			No section data avail.
KG0021A01	2007-01-10 09:50:00	2007-01-10 10:21:00	35.00	36.00	3
KG0048A01	2007-01-10 13:59:00	2007-01-10 14:26:00	32.80	33.80	3
KA3554G02	2007-01-15 09:12	2007-01-16 10:39			No section data avail.
KA3542G02	2007-01-15 09:30	2007-01-15 11:13			No section data avail.
KA3542G01	2007-03-28 09:49	2007-03-29 10:13	18,6	20,3	3
KA3542G01	2007-03-29 09:15	2007-03-29 09:45	3,5	9,5	5
KA3600F	2007-09-27 09:36	2007-09-27 09:58	40,5	42	No section data avail.
KA3600F	2007-09-27 09:36	2007-09-27 09:58	40,5	42	No section data avail.
KA3573A	2007-09-28 08:20	2007-09-28 09:16	0	40,07	No section data avail.
KA3573A	2007-09-28 08:20	2007-09-28 09:16	0	40,07	No section data avail.
KA3600F	2007-10-03 08:50	2007-10-03 09:38	43	50,1	No section data avail.
KA3600F	2007-10-03 08:50	2007-10-03 09:38	43	50,1	No section data avail.
KA3573A	2008-05-22 09:15	2008-05-22 10:30	21	24	2
KA3600F	2008-05-22 09:30	2008-05-22 10:25	43	50,1	1
KA3600F	2008-05-22 09:45	2008-05-22 10:05	40,5	42	2
KA3510A	2008-06-24 08:20	2008-06-24 08:40	125	150,06	1
KA3510A	2008-06-24 08:40	2008-06-24 09:00	125	150,06	1
KA3510A	2008-06-24 14:30	2008-06-24 14:55	125	150,06	1
KA3510A	2008-06-25 10:30	2008-06-25 10:50	125	150,06	1
KA3510A	2008-07-02 09:20	2008-07-02 09:30	125	150,06	1
KA3510A	2008-07-23 09:05	2008-08-23 09:15	125	150,06	1
KA3600F	2008-09-16 09:15	2008-09-16 10:22	40,5	42	2
KA3600F	2008-09-16 15:05	2008-09-16 15:32	43	50,1	1
KG0021A01	2008-09-17 10:55	2008-09-17 11:12	35	36	3
KA3510A	2008-10-14 16:45	2008-10-15 09:40	125	150,06	1
KG0021A01	2008-12-02 09:35	2008-12-02 09:45	35	36	3
KG0048A01	2008-12-02 09:50	2008-12-02 11:00	32,8	33,8	3
KA3510A	2009-03-09 12:50	2009-03-09 13:08			No section data avail.
KA3510A	2009-03-09 12:50	2009-03-09 13:08			No section data avail.
KA3510A	2009-03-09 12:50	2009-03-09 13:08			No section data avail.
KA3510A	2009-06-01 16:15	2009-06-01 16:30	125	150,06	1
KA3600F	2009-09-23 08:45	2009-09-23 08:48	43	50,1	1

Borehole	Start date/time	Stop date/time	Secup	Seclow	Section number
KA3600F	2009-09-23 08:55	2009-09-23 08:58	40,5	42	2
KA3600F	2009-09-23 10:15	2009-09-23 10:35	40,5	42	2
KA3600F	2009-09-23 12:00	2009-09-23 12:35	43	50,1	1
KA3542G01	2009-10-22 10:40	2009-10-22 11:25	18,6	20,3	3
KA3600F	2009-10-22 11:55	2009-10-22 12:30	40,5	42	2
KA3600F	2009-10-23 13:02	2009-10-23 13:11			No section data avail.
KA3542G01	2009-10-27 09:25	2009-10-27 09:35	18,6	20,3	3
KA3600F	2010-03-24 10:03	2010-03-24 10:03	40,5	42	2
KA3600F	2010-03-24 10:03	2010-03-24 10:03	43	50,1	1
KA3600F	2012-05-08 09:50	2012-05-08 10:30	40,5	42	2
KA3600F	2012-05-09 08:40	2012-05-09 09:45	43	50,1	1
KA3600F	2012-11-06 08:00	2012-11-06 09:05	43	50,1	1
KA3600F	2012-11-06 09:25	2012-11-06 10:03	40,5	42	2
KA3600F	2013-05-16 08:38	2013-05-16 09:38	43	50,1	1
KA3600F	2013-05-16 10:02	2013-05-16 10:40	40,5	42	2
KA3600F	2013-08-15 10:10	2013-09-04 10:45	43	50,1	1
KA3600F	2013-09-04 09:30	2013-09-04 10:10	43	50,1	1
KA3600F	2013-11-12 08:00	2013-11-12 09:20	43	50,1	1
KA3600F	2013-11-12 10:08	2013-11-12 10:38	40,5	42	2
KA3600F	2014-05-07 08:45	2014-05-07 09:34	43	50,1	1
KA3600F	2014-05-07 10:28	2014-05-07 10:54	40,5	42	2
KA3600F	2014-11-18 08:58	2014-11-18 10:03	43	50,1	1
KA3600F	2014-11-18 10:26	2014-11-18 10:57	40,5	42	2
KA3600F	2015-05-26 08:35	2015-05-26 08:52	43	50,1	1
KA3600F	2015-05-27 09:00	2015-05-27 09:45	43	50,1	1
KA3510A	2015-05-27 09:09	2015-05-27 09:24	110	124	2
KA3600F	2015-05-27 11:10	2015-05-27 11:26	40,5	42	2
KA3600F	2015-11-30 12:58	2015-11-30 13:11	43	50,1	1
KA3600F	2015-12-01 08:06	2015-12-01 08:57	43	50,1	1
KA3600F	2015-12-01 10:02	2015-12-01 10:24	40,5	42	2
KA3600F	2016-05-26 08:40	2016-05-26 09:33	43	50,1	1
KA3600F	2016-05-26 09:57	2016-05-26 10:17	40,5	42	2
KA3600F	2016-11-29 08:05	2016-11-29 09:00	43	50,1	1
KA3600F	2016-11-29 09:20	2016-11-29 10:00	40,5	42	2
KA3600F	2017-05-18 06:42	2017-05-18 07:21	40,5	42	2
KA3600F	2018-11-20 10:44	2018-11-20 11:33	40,50	42	2
KA3510A	2019-03-18 11:39	2019-03-18 12:30	110	124	2
KA3510A	2019-11-19 10:21	2019-11-19 11:16	110	124	2
KA3600F	2019-03-21 08:37	2020-03-21 09:25	40,5	42	2
KA3600F	2019-11-04 09:22	2019-11-04 10:10	30,5	42	2
KA3510A	2020-12-02 09:43	2020-12-02 10:33	110	124	2
KA3600F	2020-11-17 08:27	2020-11-27 09:23	40,5	42	2

### KA3510A PRESSURE HEAD

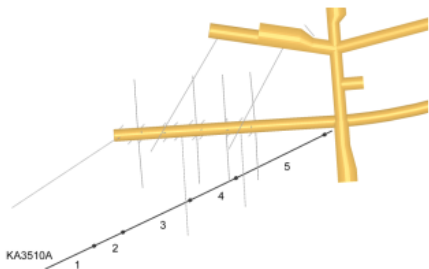
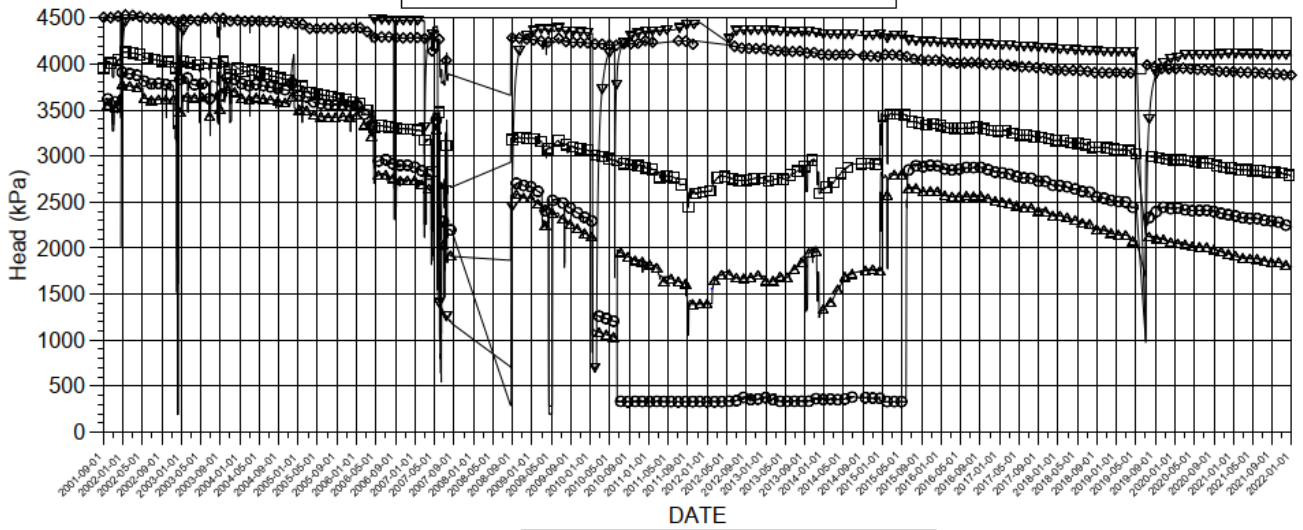

- Events**
- Start backfilling of section I 2001-09-03
  - Stop backfilling of section I 2001-11-20
  - Casting of inner plug finalized 2001-12-19
  - Start backfilling of section II 2003-04-29
  - Stop backfilling of section II 2003-06-27
  - Casting of outer plug finalized 2003-09-11
  - Packer failure of KA3573A:3 2006-04-18
  - Start drilling of Fine Sealing Project 2007-03-12
  - Start grouting of Fine Sealing Project 2007-11-19
  - Excavation start of TASS tunnel 2007-12-11
  - Excavation stop of TASS tunnel 2008-12-18
  - Demolition work start Section II December 2010
  - Demolition work Section II finalized 2011-12-15
  - Replacement of packers Section II December 2014

- Borehole sections**
- ▽ A:1 125 m - 150 m
  - ◇ A:2 110 m - 124 m
  - A:3 75 m - 109 m
  - A:4 51 m - 74 m
  - ▲ A:5 4.5 m - 50 m

P\_KA3510A.GRF 2022-10-19

### KA3563A01, KA3563D01, KA3563I01 PRESSURE HEAD

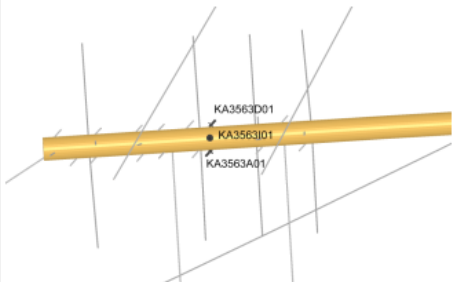
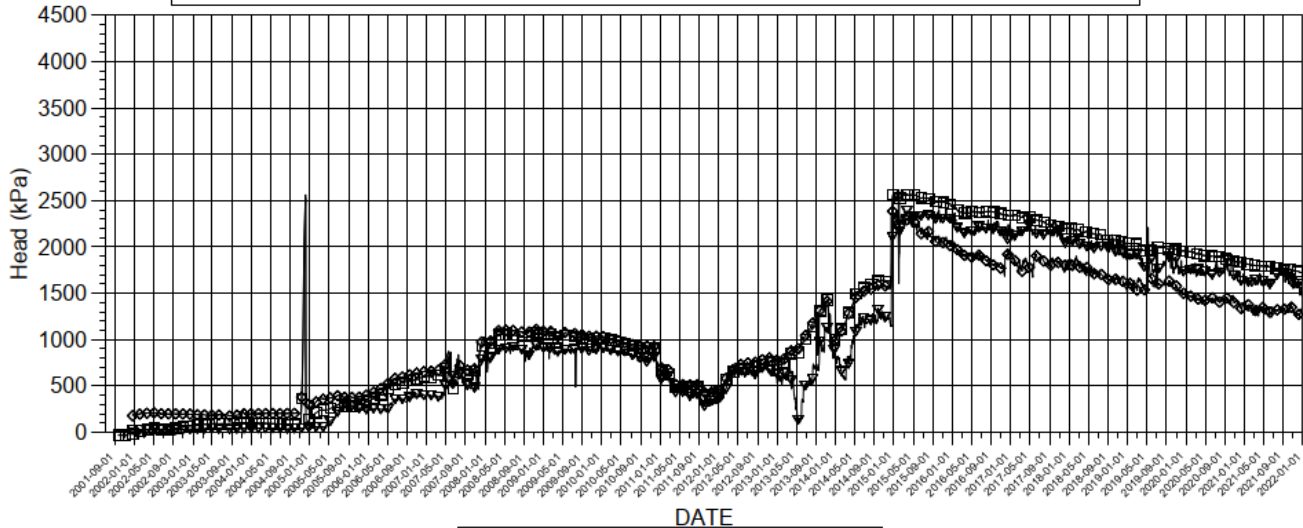

- Events**
- Start backfilling of section I 2001-09-03
  - Stop backfilling of section I 2001-11-20
  - Casting of inner plug finalized 2001-12-19
  - Start backfilling of section II 2003-04-29
  - Stop backfilling of section II 2003-06-27
  - Casting of outer plug finalized 2003-09-11
  - Packer failure of KA3573A:3 2006-04-18
  - Start drilling of Fine Sealing Project 2007-03-12
  - Start grouting of Fine Sealing Project 2007-11-19
  - Excavation start of TASS tunnel 2007-12-11
  - Excavation stop of TASS tunnel 2008-12-18
  - Demolition work start Section II December 2010
  - Demolition work Section II finalized 2011-12-15
  - Replacement of packers Section II December 2014

- Borehole sections**
- ▽ KA3563A01:1 0.65 m - 2 m
  - ◇ KA3563D01:1 0.65 m - 2 m
  - KA3563I01:1 0.65 m - 2 m

P\_KA3563A01-P\_KA3563I01.GRF 2022-10-19



### KA3563G PRESSURE HEAD

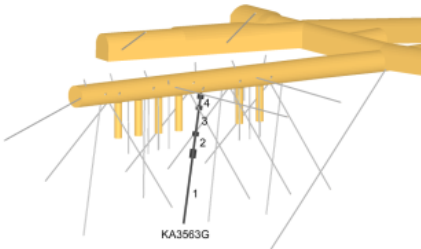
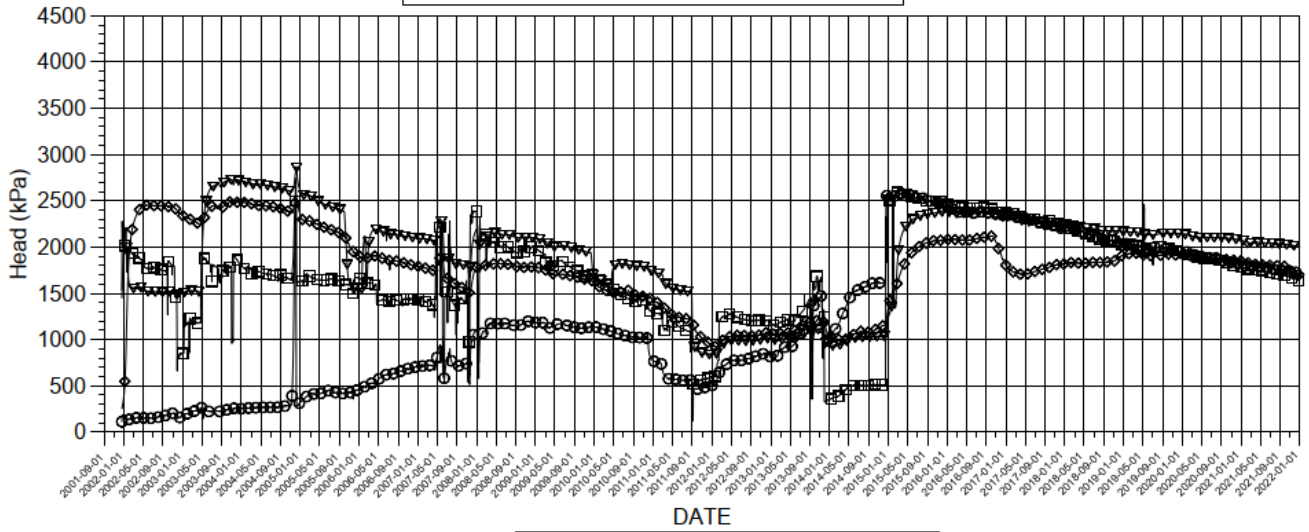

- Events**
- Start backfilling of section I 2001-09-03
  - Stop backfilling of section I 2001-11-20
  - Casting of inner plug finalized 2001-12-19
  - Start backfilling of section II 2003-04-29
  - Stop backfilling of section II 2003-06-27
  - Casting of outer plug finalized 2003-09-11
  - Packer failure of KA3573A:3 2006-04-18
  - Start drilling of Fine Sealing Project 2007-03-12
  - Start grouting of Fine Sealing Project 2007-11-19
  - Excavation start of TASS tunnel 2007-12-11
  - Excavation stop of TASS tunnel 2008-12-18
  - Demolition work start Section II December 2010
  - Demolition work Section II finalized 2011-12-15
  - Replacement of packers Section II December 2014

- Borehole sections**
- ▽ G:1 15 m - 30 m
  - ◇ G:2 10 m - 13 m
  - G:3 4 m - 8 m
  - G:4 1.5 m - 3 m

P\_KA3563G.GRF 2022-10-19

### KA3566C01, KA3568D01, KA3573C01, KA3574D01 PRESSURE HEAD

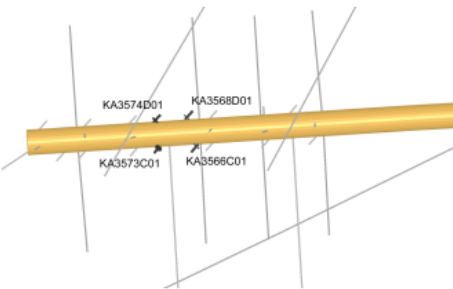
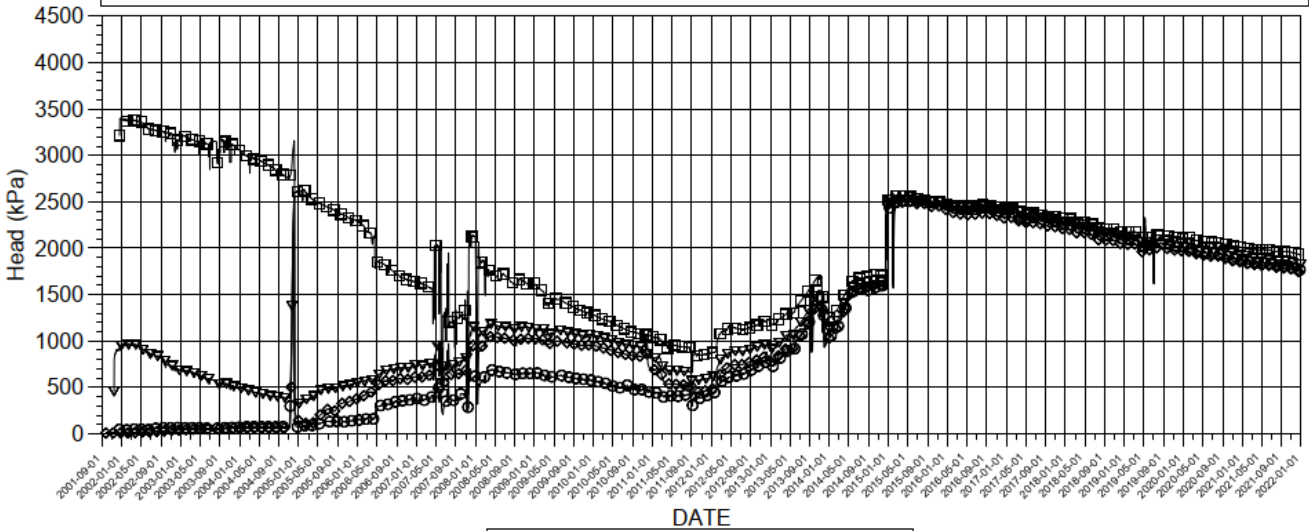

- Events**
- Start backfilling of section I 2001-09-03
  - Stop backfilling of section I 2001-11-20
  - Casting of inner plug finalized 2001-12-19
  - Start backfilling of section II 2003-04-29
  - Stop backfilling of section II 2003-06-27
  - Casting of outer plug finalized 2003-09-11
  - Packer failure of KA3573A:3 2006-04-18
  - Start drilling of Fine Sealing Project 2007-03-12
  - Start grouting of Fine Sealing Project 2007-11-19
  - Excavation start of TASS tunnel 2007-12-11
  - Excavation stop of TASS tunnel 2008-12-18
  - Demolition work start Section II December 2010
  - Demolition work Section II finalized 2011-12-15
  - Replacement of packers Section II December 2014

- Borehole sections**
- ▽ KA3566C01:1 0.65 m - 2 m
  - ◇ KA3568D01:1 0.65 m - 2 m
  - KA3573C01:1 0.65 m - 2 m
  - KA3574D01:1 0.65 m - 2 m

P\_KA3566C01-P\_KA3574D01.GRF 2022-10-19

## KA3566G01 PRESSURE HEAD

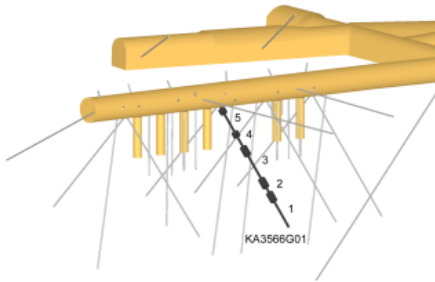
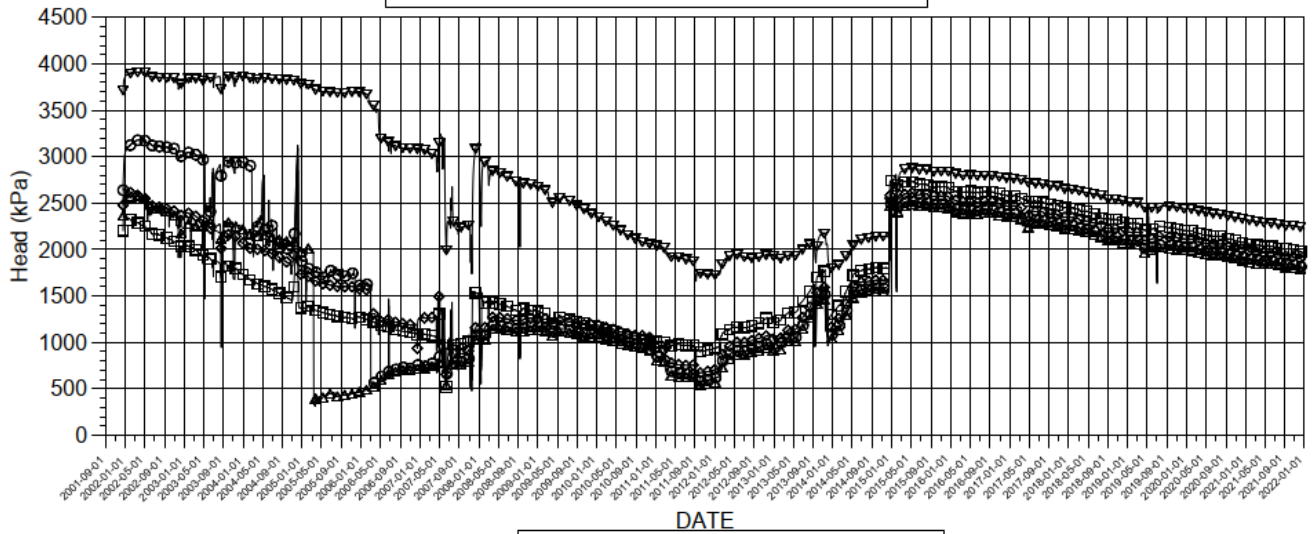

### Events

- Start backfilling of section I 2001-09-03
- Stop backfilling of section I 2001-11-20
- Casting of inner plug finalized 2001-12-19
- Start backfilling of section II 2003-04-29
- Stop backfilling of section II 2003-06-27
- Casting of outer plug finalized 2003-09-11
- Packer failure of KA3573A:3 2006-04-18
- Start drilling of Fine Sealing Project 2007-03-12
- Start grouting of Fine Sealing Project 2007-11-19
- Excavation start of TASS tunnel 2007-12-11
- Excavation stop of TASS tunnel 2008-12-18
- Demolition work start Section II December 2010
- Demolition work Section II finalized 2011-12-15
- Replacement of packers Section II December 2014

### Borehole sections

- ▼—▼ G01:1 23.5 m - 30 m
- ◆—◆ G01:2 20 m - 21.5 m
- G01:3 12 m - 18 m
- G01:4 7.3 m - 10 m
- ▲—▲ G01:5 1.5 m - 6.3 m

P\_KA3566G01.GRF 2022-10-19

# KA3566G02 PRESSURE HEAD

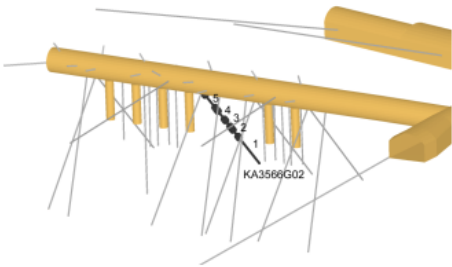
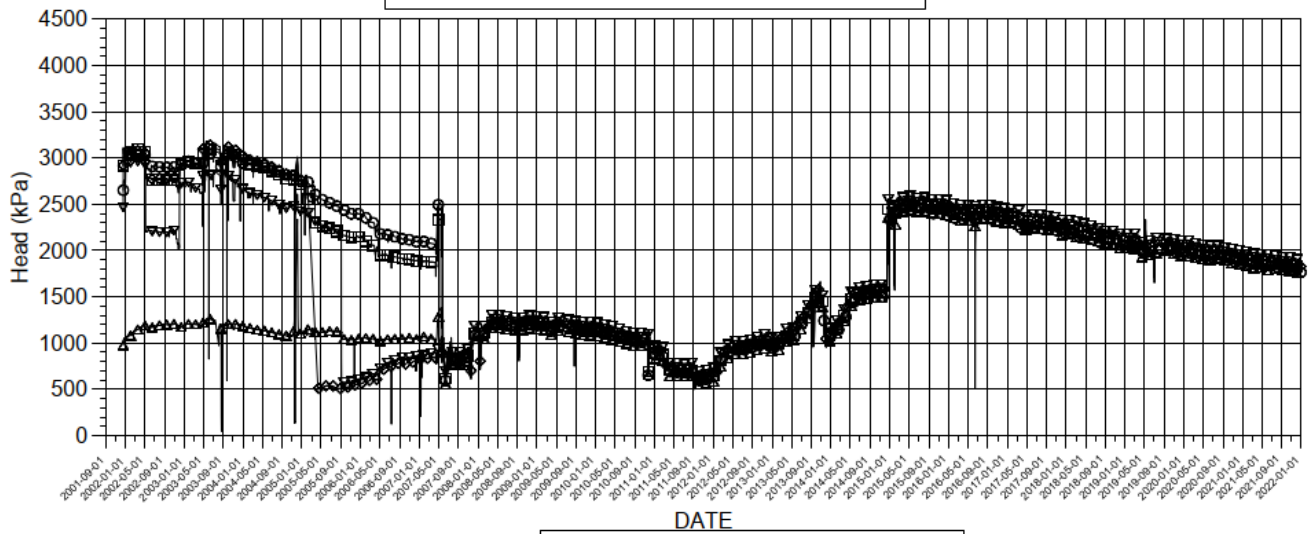

## Events

- Start backfilling of section I 2001-09-03
- Stop backfilling of section I 2001-11-20
- Casting of inner plug finalized 2001-12-19
- Start backfilling of section II 2003-04-29
- Stop backfilling of section II 2003-06-27
- Casting of outer plug finalized 2003-09-11
- Packer failure of KA3573A:3 2006-04-18
- Start drilling of Fine Sealing Project 2007-03-12
- Start grouting of Fine Sealing Project 2007-11-19
- Excavation start of TASS tunnel 2007-12-11
- Excavation stop of TASS tunnel 2008-12-18
- Demolition work start Section II December 2010
- Demolition work Section II finalized 2011-12-15
- Replacement of packers Section II December 2014

## Borehole sections

- ▽—▽ G02:1 19 m - 30 m
- ◇—◇ G02:2 16 m - 18 m
- G02:3 12 m - 14 m
- G02:4 8 m - 11 m
- △—△ G02:5 1.5 m - 6 m

P\_KA3566G02.GRF 2022-10-19

### KA3572G01 PRESSURE HEAD

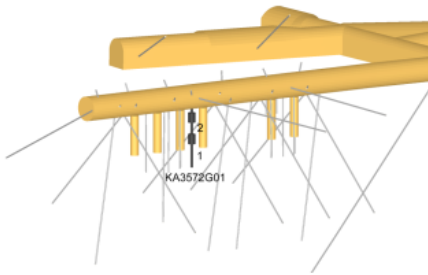
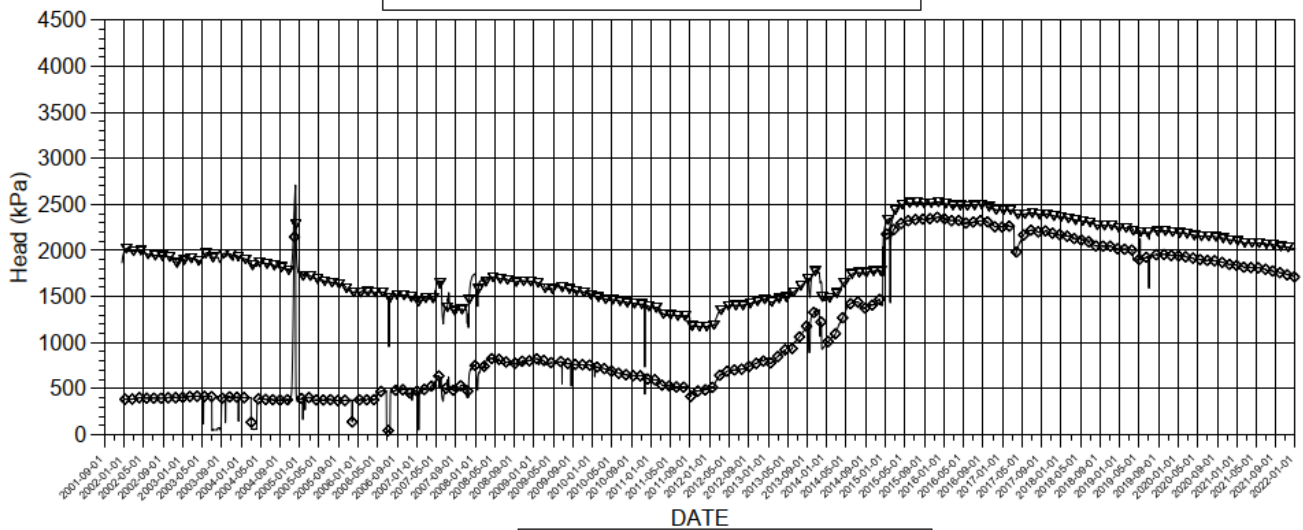

- Events**
- Start backfilling of section I 2001-09-03
  - Stop backfilling of section I 2001-11-20
  - Casting of inner plug finalized 2001-12-19
  - Start backfilling of section II 2003-04-29
  - Stop backfilling of section II 2003-06-27
  - Casting of outer plug finalized 2003-09-11
  - Packer failure of KA3573A:3 2006-04-18
  - Start drilling of Fine Sealing Project 2007-03-12
  - Start grouting of Fine Sealing Project 2007-11-19
  - Excavation start of TASS tunnel 2007-12-11
  - Excavation stop of TASS tunnel 2008-12-18
  - Demolition work start Section II December 2010
  - Demolition work Section II finalized 2011-12-15
  - Replacement of packers Section II December 2014

- Borehole sections**
- ▼ G01:1 7.3 m - 12.0 m
  - ◆ G01:2 2.7 m - 5.3 m

P\_KA3572G01.GRF 2022-10-19

### KA3573A PRESSURE HEAD

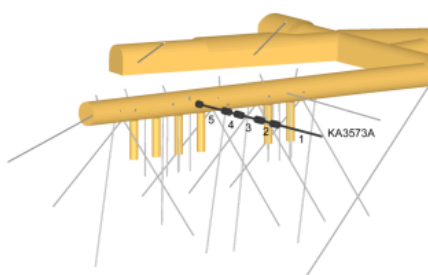
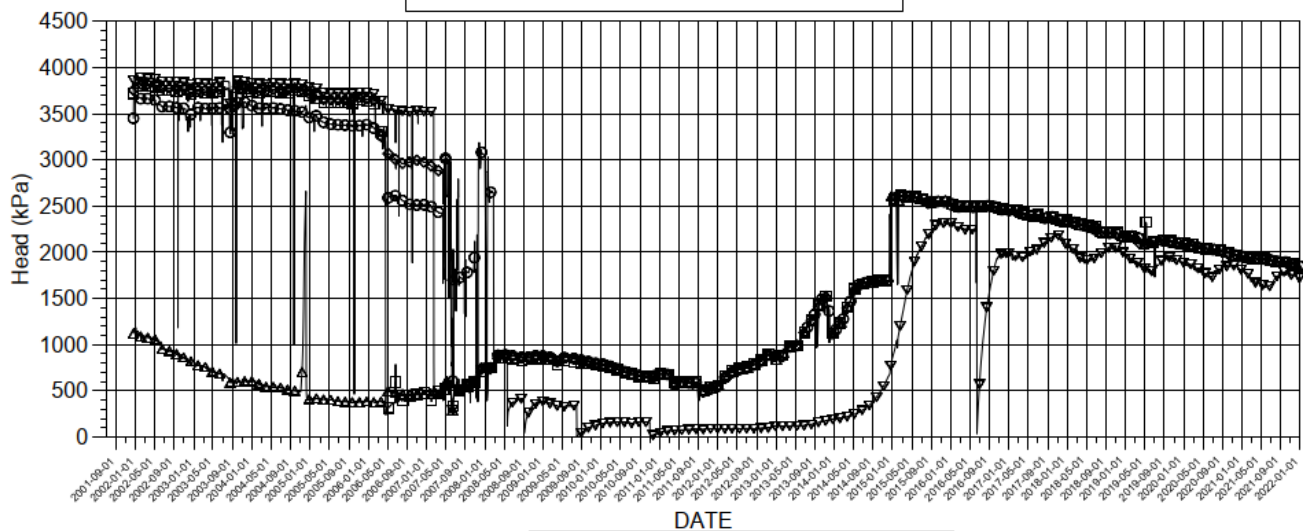

- Events**
- Start backfilling of section I 2001-09-03
  - Stop backfilling of section I 2001-11-20
  - Casting of inner plug finalized 2001-12-19
  - Start backfilling of section II 2003-04-29
  - Stop backfilling of section II 2003-06-27
  - Casting of outer plug finalized 2003-09-11
  - Packer failure of KA3573A:3 2006-04-18
  - Start drilling of Fine Sealing Project 2007-03-12
  - Start grouting of Fine Sealing Project 2007-11-19
  - Excavation start of TASS tunnel 2007-12-11
  - Excavation stop of TASS tunnel 2008-12-18
  - Demolition work start Section II December 2010
  - Demolition work Section II finalized 2011-12-15
  - Replacement of packers Section II December 2014

- Borehole sections**
- ▼ A:1 26 m - 40.1 m
  - ◆ A:2 21 m - 24 m
  - A:3 14.5 m - 19 m
  - A:4 10.5 m - 12.5 m
  - ▲ A:5 3.4 m - 8.5 m

P\_KA3573A.GRF 2022-10-19

## KA3574G01 PRESSURE HEAD

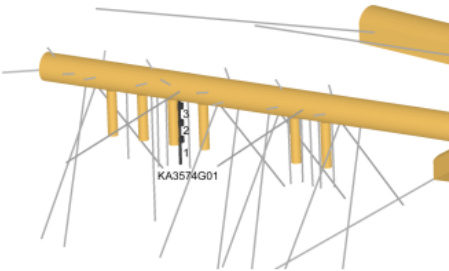
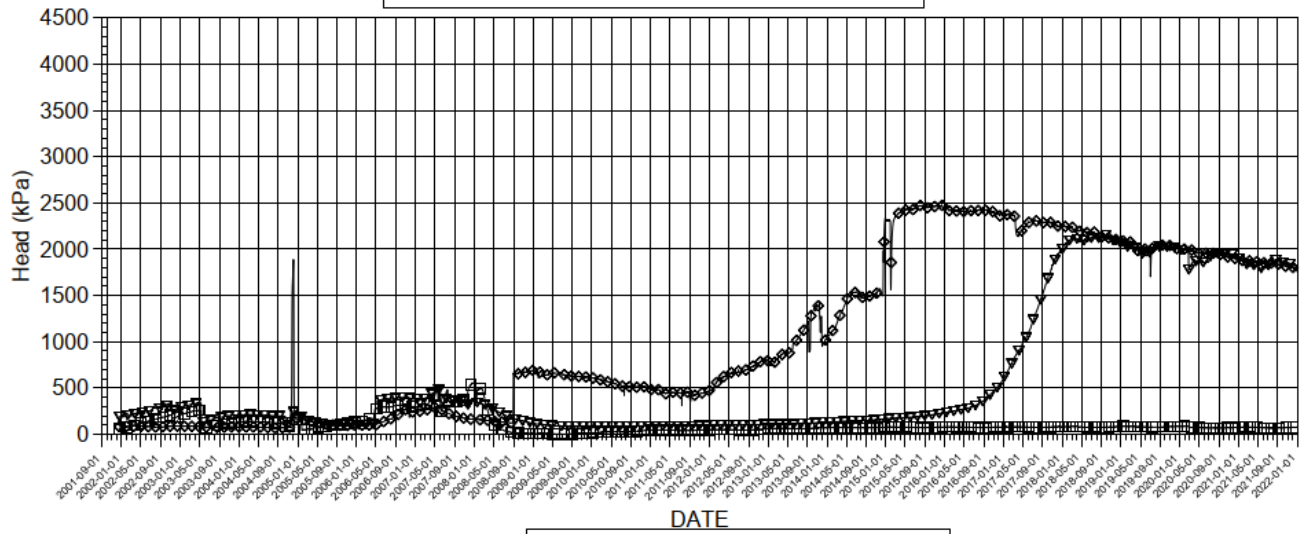

- Events**
- Start backfilling of section I 2001-09-03
  - Stop backfilling of section I 2001-11-20
  - Casting of inner plug finalized 2001-12-19
  - Start backfilling of section II 2003-04-29
  - Stop backfilling of section II 2003-06-27
  - Casting of outer plug finalized 2003-09-11
  - Packer failure of KA3573A:3 2006-04-18
  - Start drilling of Fine Sealing Project 2007-03-12
  - Start grouting of Fine Sealing Project 2007-11-19
  - Excavation start of TASS tunnel 2007-12-11
  - Excavation stop of TASS tunnel 2008-12-18
  - Demolition work start Section II December 2010
  - Demolition work Section II finalized 2011-12-15
  - Replacement of packers Section II December 2014

- Borehole sections**
- ▼ G01:1 8 m - 12 m
  - ◆ G01:2 5.1 m - 7 m
  - G01:3 1.8 m - 4.1 m

# KA3576G01 PRESSURE HEAD

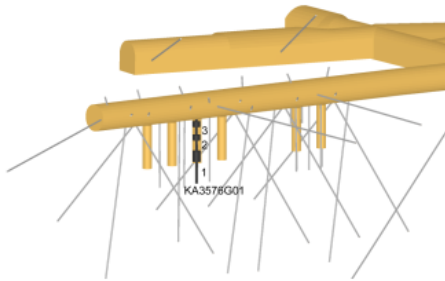
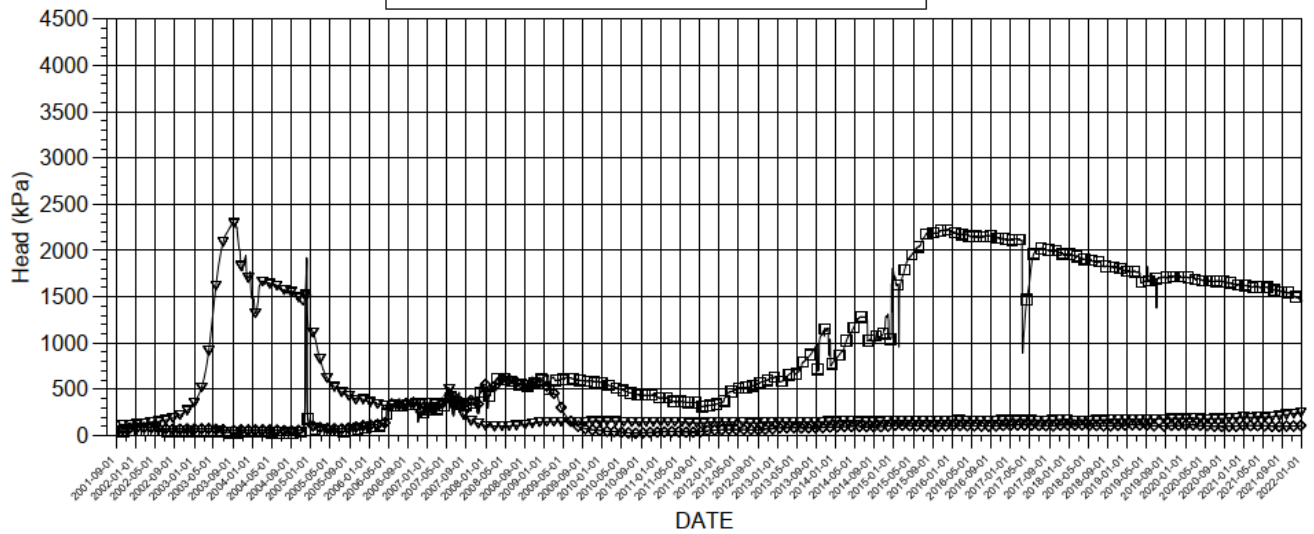

- Events**
- Start backfilling of section I 2001-09-03
  - Stop backfilling of section I 2001-11-20
  - Casting of inner plug finalized 2001-12-19
  - Start backfilling of section II 2003-04-29
  - Stop backfilling of section II 2003-06-27
  - Casting of outer plug finalized 2003-09-11
  - Packer failure of KA3573A:3 2006-04-18
  - Start drilling of Fine Sealing Project 2007-03-12
  - Start grouting of Fine Sealing Project 2007-11-19
  - Excavation start of TASS tunnel 2007-12-11
  - Excavation stop of TASS tunnel 2008-12-18
  - Demolition work start Section II December 2010
  - Demolition work Section II finalized 2011-12-15
  - Replacement of packers Section II December 2014

- Borehole sections**
- ▼ G01:1 7.9 m - 12 m
  - ◆ G01:2 3.9 m - 5.9 m
  - G01:3 1.4 m - 2.9 m



### KA3578C01, KA3578H01, KA3579D01 PRESSURE HEAD

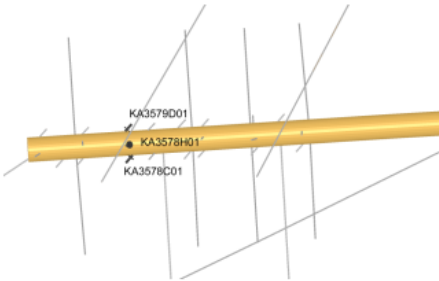
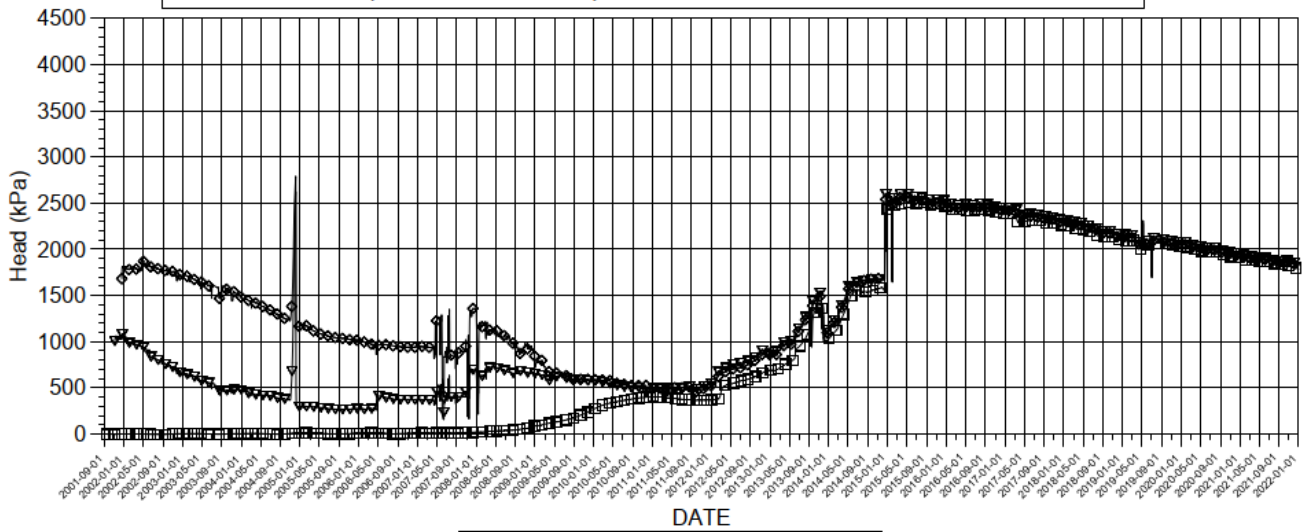

- Events**
- Start backfilling of section I 2001-09-03
  - Stop backfilling of section I 2001-11-20
  - Casting of inner plug finalized 2001-12-19
  - Start backfilling of section II 2003-04-29
  - Stop backfilling of section II 2003-06-27
  - Casting of outer plug finalized 2003-09-11
  - Packer failure of KA3573A:3 2006-04-18
  - Start drilling of Fine Sealing Project 2007-03-12
  - Start grouting of Fine Sealing Project 2007-11-19
  - Excavation start of TASS tunnel 2007-12-11
  - Excavation stop of TASS tunnel 2008-12-18
  - Demolition work start Section II December 2010
  - Demolition work Section II finalized 2011-12-15
  - Replacement of packers Section II December 2014

- Borehole sections**
- ▼ KA3578C01:1 0.65 m - 2 m
  - ◆ KA3578H01:1 0.65 m - 2 m
  - KA3579D01:1 0.65 m - 2 m

P\_KA3578C01-P\_KA3579D01.GRF 2022-10-19

### KA3578G01 PRESSURE HEAD

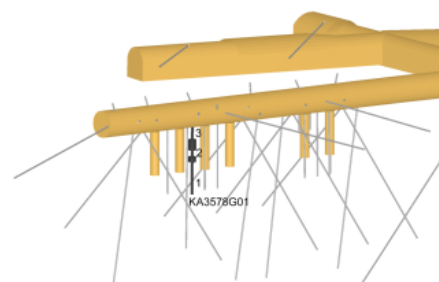
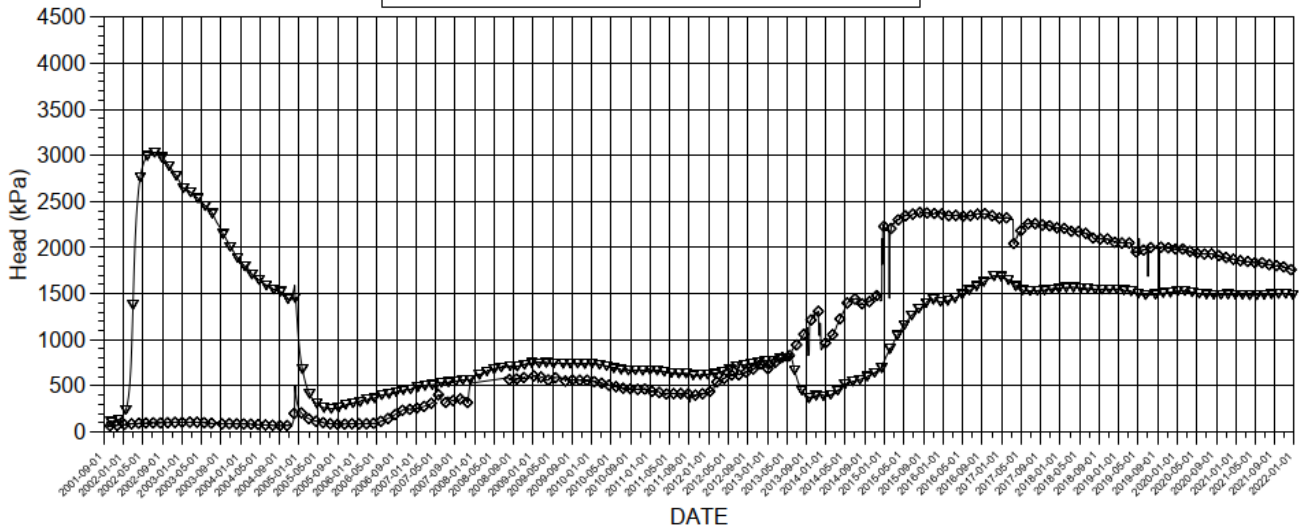

- Events**
- Start backfilling of section I 2001-09-03
  - Stop backfilling of section I 2001-11-20
  - Casting of inner plug finalized 2001-12-19
  - Start backfilling of section II 2003-04-29
  - Stop backfilling of section II 2003-06-27
  - Casting of outer plug finalized 2003-09-11
  - Packer failure of KA3573A:3 2006-04-18
  - Start drilling of Fine Sealing Project 2007-03-12
  - Start grouting of Fine Sealing Project 2007-11-19
  - Excavation start of TASS tunnel 2007-12-11
  - Excavation stop of TASS tunnel 2008-12-18
  - Demolition work start Section II December 2010
  - Demolition work Section II finalized 2011-12-15
  - Replacement of packers Section II December 2014

- Borehole sections**
- ▼ G01:1 6.5 m - 12.6 m
  - ◆ G01:2 4.3 m - 5.5 m

P\_KA3578G01.GRF 2022-10-19

# KA3579G PRESSURE HEAD

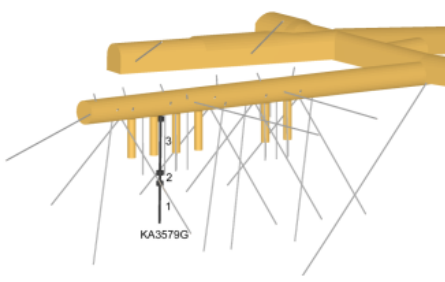
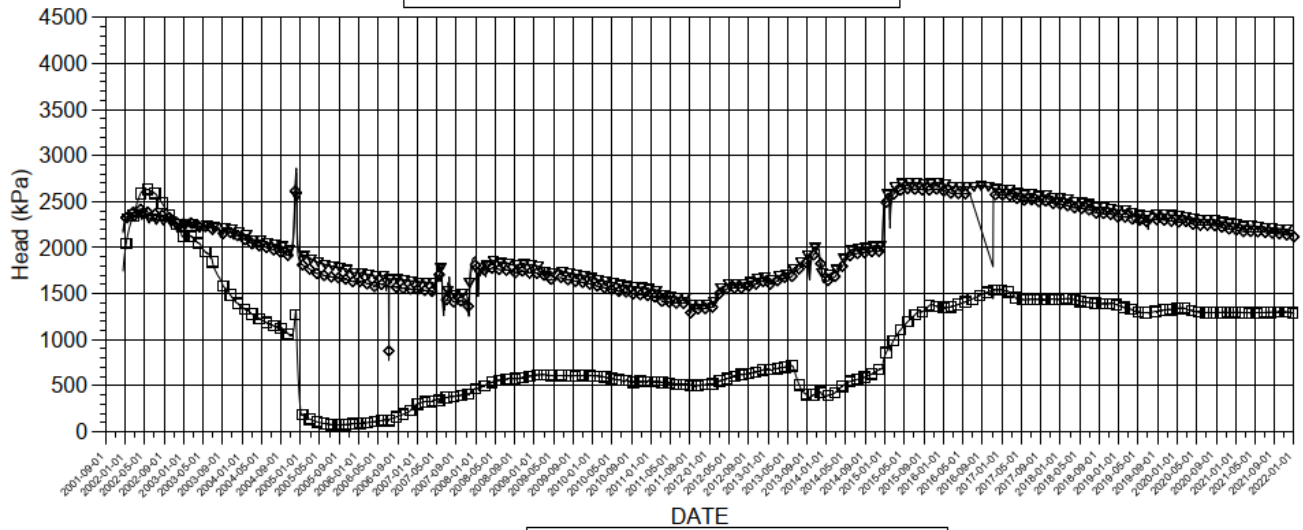

- Events**
- Start backfilling of section I 2001-09-03
  - Stop backfilling of section I 2001-11-20
  - Casting of inner plug finalized 2001-12-19
  - Start backfilling of section II 2003-04-29
  - Stop backfilling of section II 2003-06-27
  - Casting of outer plug finalized 2003-09-11
  - Packer failure of KA3573A:3 2006-04-18
  - Start drilling of Fine Sealing Project 2007-03-12
  - Start grouting of Fine Sealing Project 2007-11-19
  - Excavation start of TASS tunnel 2007-12-11
  - Excavation stop of TASS tunnel 2008-12-18
  - Demolition work start Section II December 2010
  - Demolition work Section II finalized 2011-12-15
  - Replacement of packers Section II December 2014

- Borehole sections**
- ▼——▼ G:1 14.7 m - 22.7 m
  - ◆——◆ G:2 12.5 m - 13.7 m
  - G:3 2.5 m - 11.5 m



# KA3584G01 PRESSURE HEAD

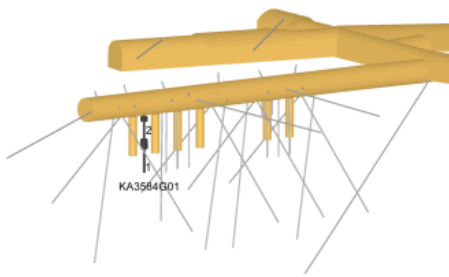
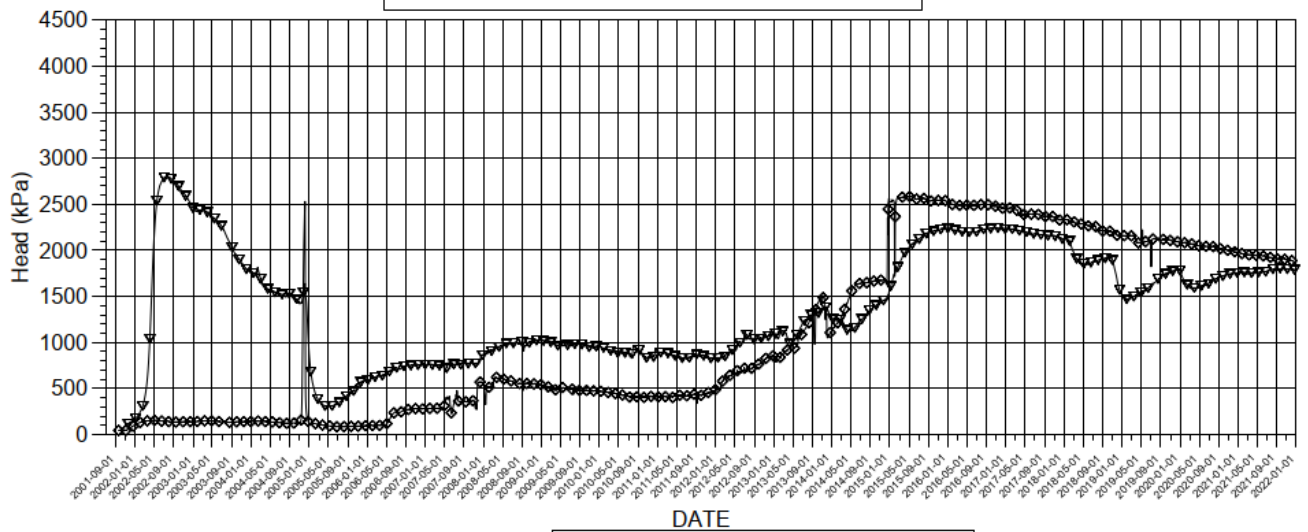

## Events

- Start backfilling of section I 2001-09-03
- Stop backfilling of section I 2001-11-20
- Casting of inner plug finalized 2001-12-19
- Start backfilling of section II 2003-04-29
- Stop backfilling of section II 2003-06-27
- Casting of outer plug finalized 2003-09-11
- Packer failure of KA3573A:3 2006-04-18
- Start drilling of Fine Sealing Project 2007-03-12
- Start grouting of Fine Sealing Project 2007-11-19
- Excavation start of TASS tunnel 2007-12-11
- Excavation stop of TASS tunnel 2008-12-18
- Demolition work start Section II December 2010
- Demolition work Section II finalized 2011-12-15
- Replacement of packers Section II December 2014

## Borehole sections

- ▼—▼ G01:1.7 m - 12 m
- ◆—◆ G01:2.1.4 m - 5 m

## KA3588C01, KA3588D01, KA3588I01 PRESSURE HEAD

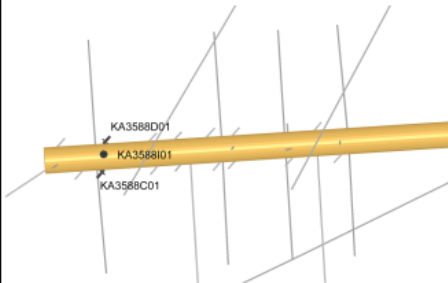
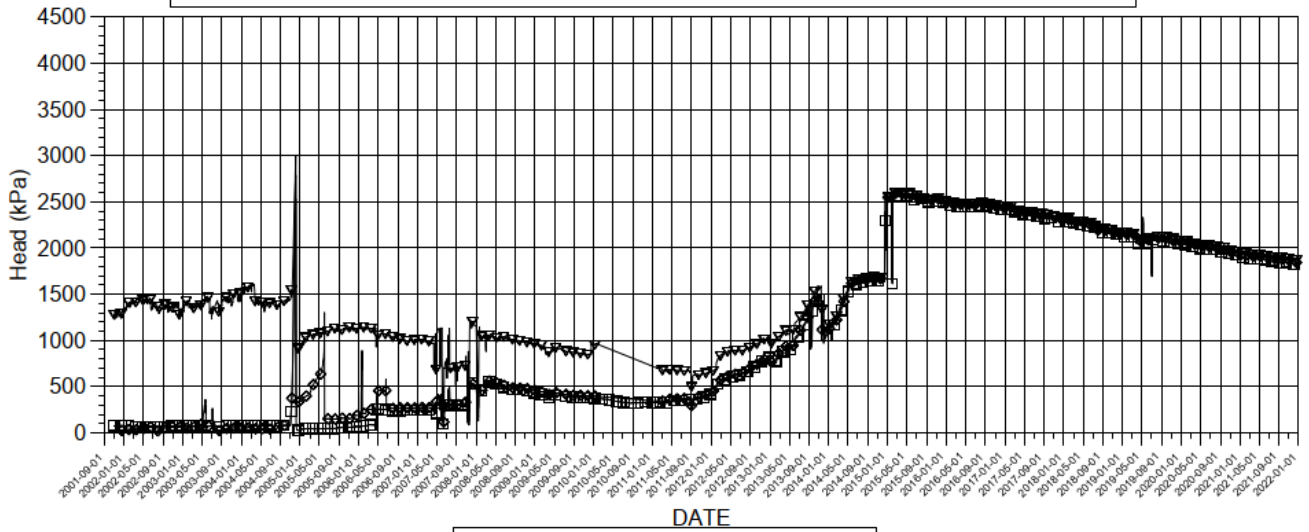

- Events**
- Start backfilling of section I 2001-09-03
  - Stop backfilling of section I 2001-11-20
  - Casting of inner plug finalized 2001-12-19
  - Start backfilling of section II 2003-04-29
  - Stop backfilling of section II 2003-06-27
  - Casting of outer plug finalized 2003-09-11
  - Packer failure of KA3573A:3 2006-04-18
  - Start drilling of Fine Sealing Project 2007-03-12
  - Start grouting of Fine Sealing Project 2007-11-19
  - Excavation start of TASS tunnel 2007-12-11
  - Excavation stop of TASS tunnel 2008-12-18
  - Demolition work start Section II December 2010
  - Demolition work Section II finalized 2011-12-15
  - Replacement of packers Section II December 2014

- Borehole sections**
- ▼ KA3588C01:1 0.65 m - 2 m
  - ◆ KA3588D01:1 0.65 m - 2 m
  - KA3588I01:1 0.65 m - 2 m

P\_KA3588C01-P\_KA3588I01.GRF 2022-10-19

## KA3590G01 PRESSURE HEAD

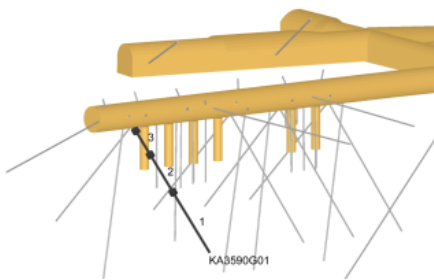
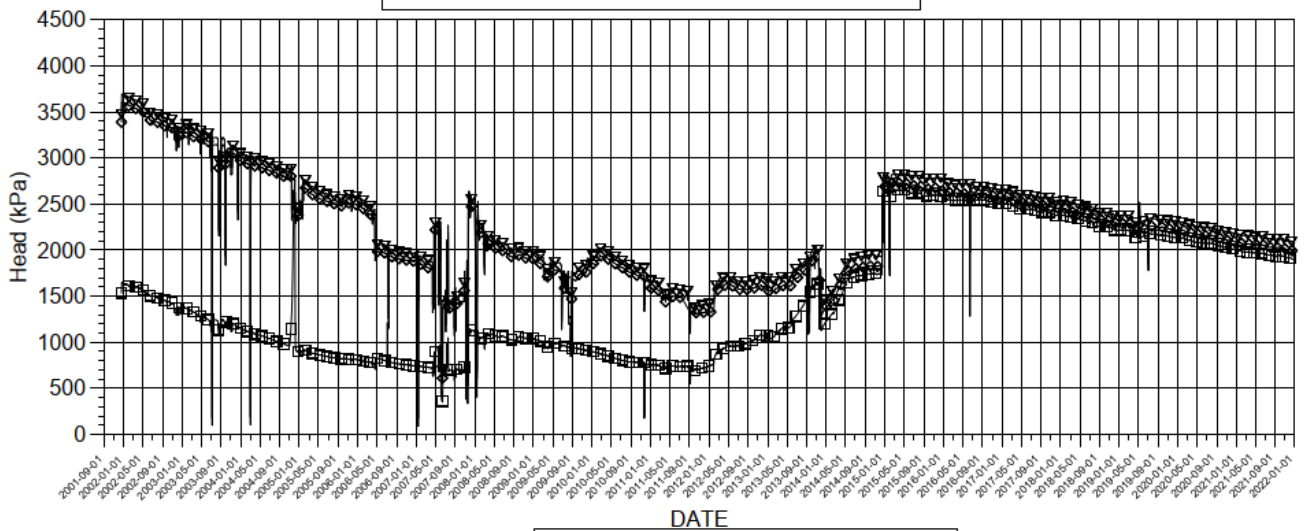

- Events**
- Start backfilling of section I 2001-09-03
  - Stop backfilling of section I 2001-11-20
  - Casting of inner plug finalized 2001-12-19
  - Start backfilling of section II 2003-04-29
  - Stop backfilling of section II 2003-06-27
  - Casting of outer plug finalized 2003-09-11
  - Packer failure of KA3573A:3 2006-04-18
  - Start drilling of Fine Sealing Project 2007-03-12
  - Start grouting of Fine Sealing Project 2007-11-19
  - Excavation start of TASS tunnel 2007-12-11
  - Excavation stop of TASS tunnel 2008-12-18
  - Demolition work start Section II December 2010
  - Demolition work Section II finalized 2011-12-15
  - Replacement of packers Section II December 2014

- Borehole sections**
- ▼ G01:1 16 m - 30 m
  - ◆ G01:2 7 m - 15 m
  - G01:3 1.5 m - 6 m

P\_KA3590G01.GRF 2022-10-19

## KA3590G02 PRESSURE HEAD

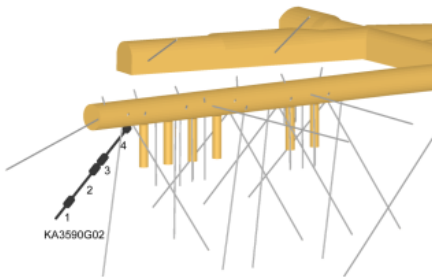
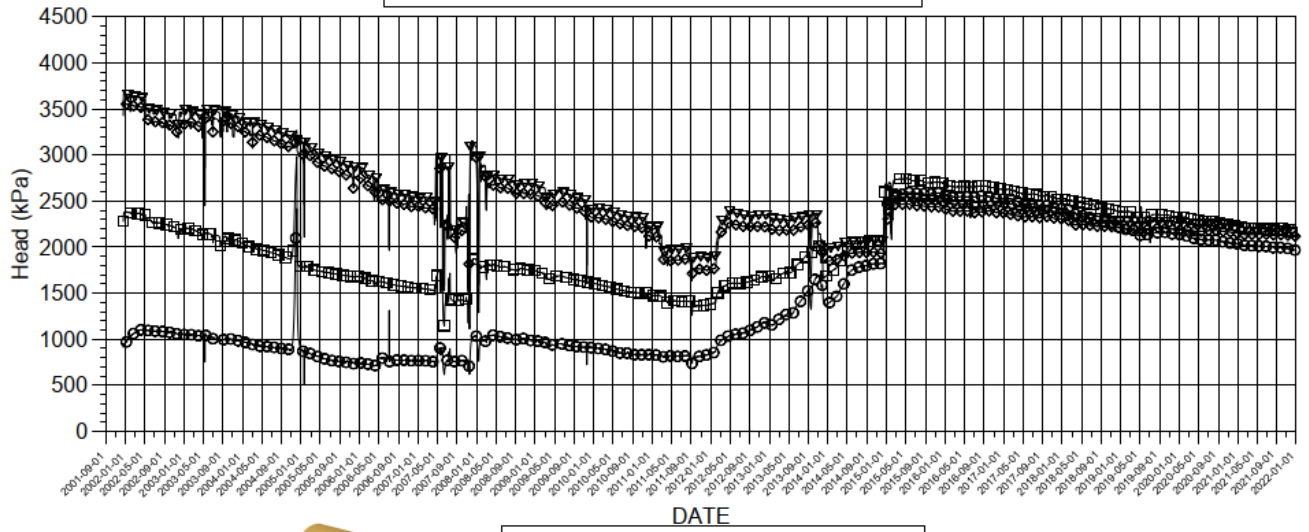

### Events

- Start backfilling of section I 2001-09-03
- Stop backfilling of section I 2001-11-20
- Casting of inner plug finalized 2001-12-19
- Start backfilling of section II 2003-04-29
- Stop backfilling of section II 2003-06-27
- Casting of outer plug finalized 2003-09-11
- Packer failure of KA3573A:3 2006-04-18
- Start drilling of Fine Sealing Project 2007-03-12
- Start grouting of Fine Sealing Project 2007-11-19
- Excavation start of TASS tunnel 2007-12-11
- Excavation stop of TASS tunnel 2008-12-18
- Demolition work start Section II December 2010
- Demolition work Section II finalized 2011-12-15
- Replacement of packers Section II December 2014

### Borehole sections

- ▼ — ▼ G02:1 25.65 m - 30 m
- ◆ — ◆ G02:2 15.35 m - 23.65 m
- — □ G02:3 12.05 m - 13.35 m
- — ○ G02:4 1.65 m - 10.05 m

P\_KA3590G02.GRF 2022-10-19

# KA3592C01, KA3597D01, KA3597H01 PRESSURE HEAD

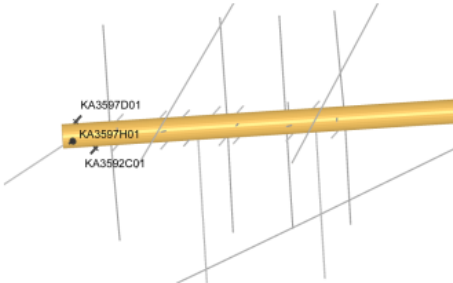
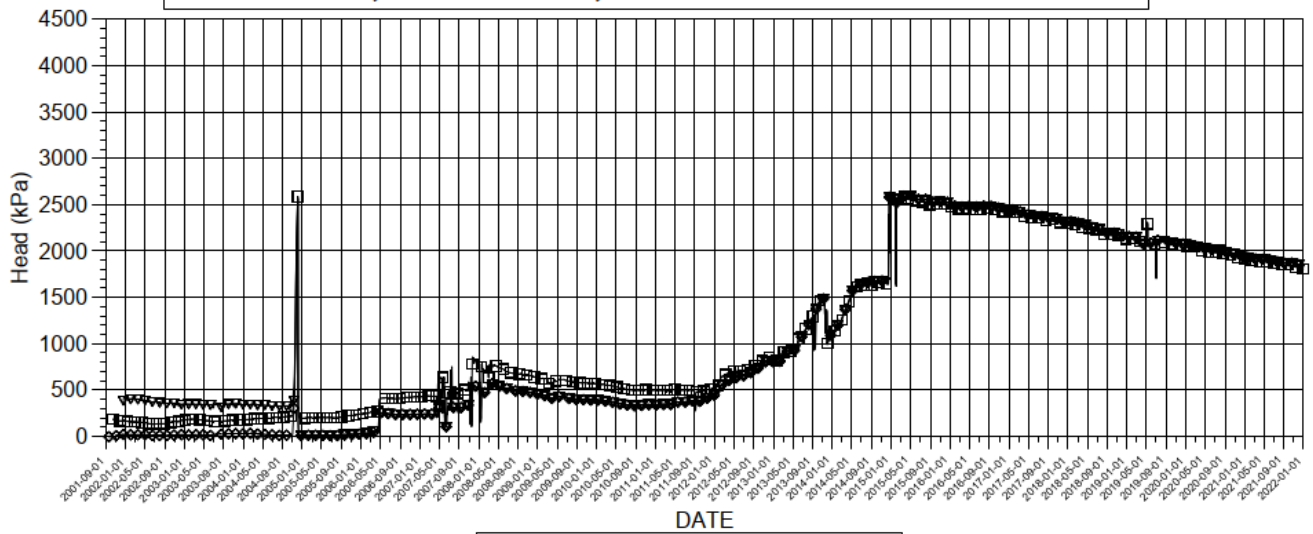

## Events

- Start backfilling of section I 2001-09-03
- Stop backfilling of section I 2001-11-20
- Casting of inner plug finalized 2001-12-19
- Start backfilling of section II 2003-04-29
- Stop backfilling of section II 2003-06-27
- Casting of outer plug finalized 2003-09-11
- Packer failure of KA3573A:3 2006-04-18
- Start drilling of Fine Sealing Project 2007-03-12
- Start grouting of Fine Sealing Project 2007-11-19
- Excavation start of TASS tunnel 2007-12-11
- Excavation stop of TASS tunnel 2008-12-18
- Demolition work start Section II December 2010
- Demolition work Section II finalized 2011-12-15
- Replacement of packers Section II December 2014

## Borehole sections

- ▽ KA3592C01:1 0.65 m - 2 m
- ◇ KA3597D01:1 0.65 m - 2 m
- KA3597H01:1 0.65 m - 2 m

## KA3593G PRESSURE HEAD

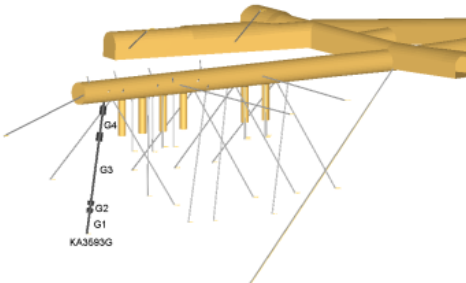
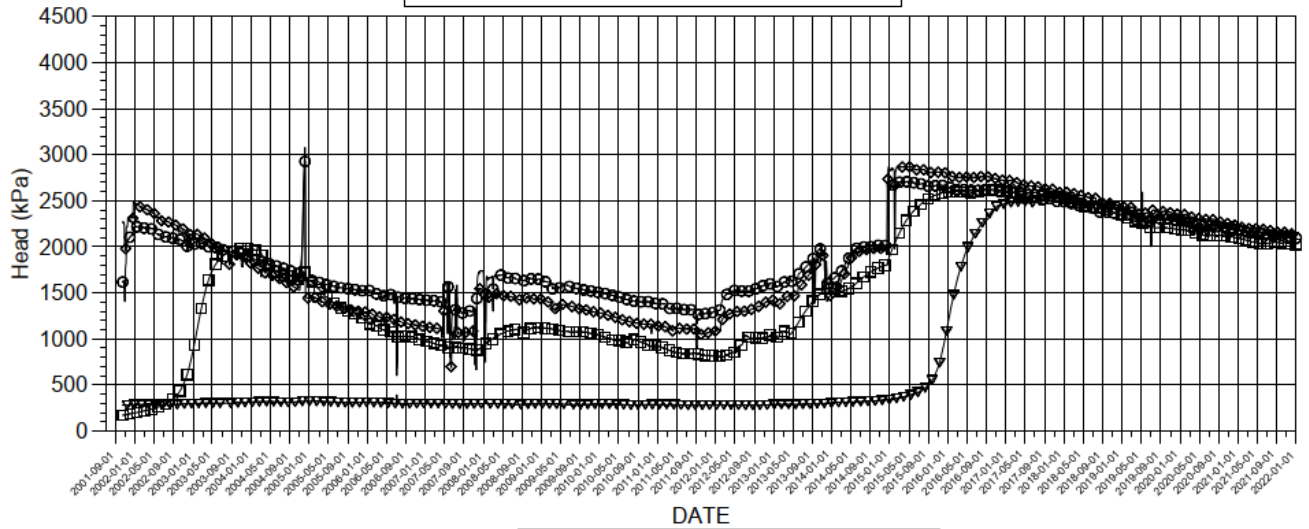

- Events**
- Start backfilling of section I 2001-09-03
  - Stop backfilling of section I 2001-11-20
  - Casting of inner plug finalized 2001-12-19
  - Start backfilling of section II 2003-04-29
  - Stop backfilling of section II 2003-06-27
  - Casting of outer plug finalized 2003-09-11
  - Packer failure of KA3573A:3 2006-04-18
  - Start drilling of Fine Sealing Project 2007-03-12
  - Start grouting of Fine Sealing Project 2007-11-19
  - Excavation start of TASS tunnel 2007-12-11
  - Excavation stop of TASS tunnel 2008-12-18
  - Demolition work start Section II December 2010
  - Demolition work Section II finalized 2011-12-15
  - Replacement of packers Section II December 2014

- Borehole sections**
- ▽ G:1 25.2 m - 30 m
  - ◇ G:2 23.5 m - 24.2 m
  - G:3 9 m - 22.5 m
  - G:4 3 m - 7 m

P\_KA3593G.GRF 2022-10-19

## KA3600F PRESSURE HEAD

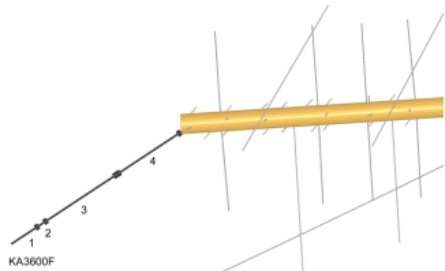
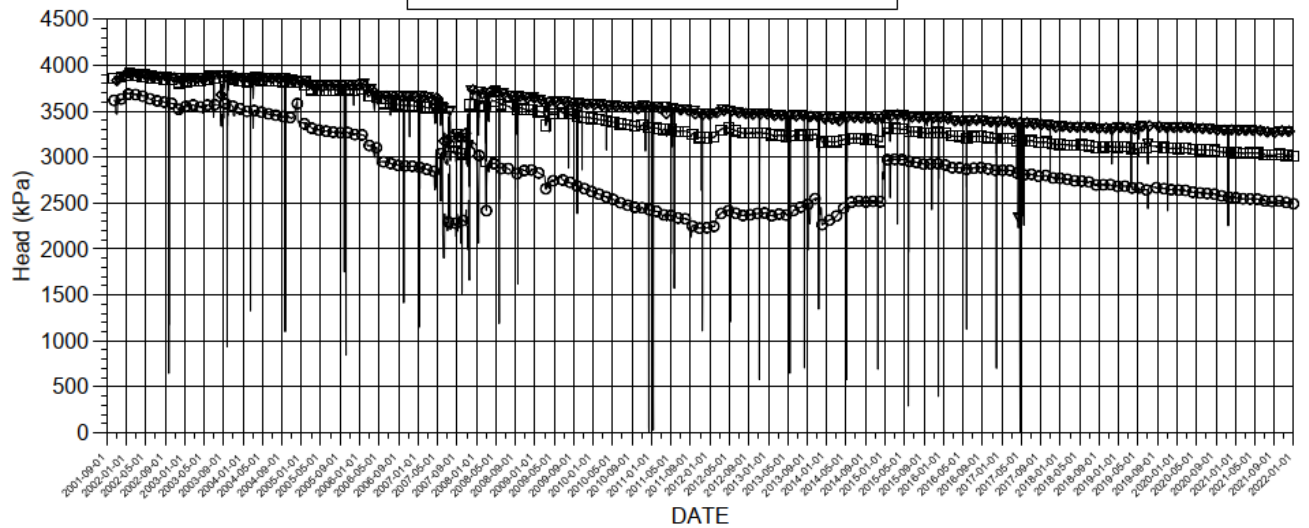

- Events**
- Start backfilling of section I 2001-09-03
  - Stop backfilling of section I 2001-11-20
  - Casting of inner plug finalized 2001-12-19
  - Start backfilling of section II 2003-04-29
  - Stop backfilling of section II 2003-06-27
  - Casting of outer plug finalized 2003-09-11
  - Packer failure of KA3573A:3 2006-04-18
  - Start drilling of Fine Sealing Project 2007-03-12
  - Start grouting of Fine Sealing Project 2007-11-19
  - Excavation start of TASS tunnel 2007-12-11
  - Excavation stop of TASS tunnel 2008-12-18
  - Demolition work start Section II December 2010
  - Demolition work Section II finalized 2011-12-15
  - Replacement of packers Section II December 2014

- Borehole sections**
- ▽ F:1 43 m - 50.1 m
  - ◇ F:2 40.5 m - 42 m
  - F:3 20 m - 39.5 m
  - F:4 3.4 m - 18 m

P\_KA3600F.GRF 2022-10-19

## KG0021A01 PRESSURE HEAD

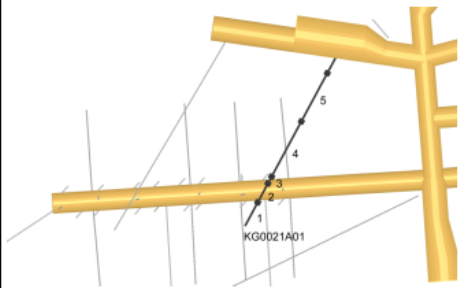
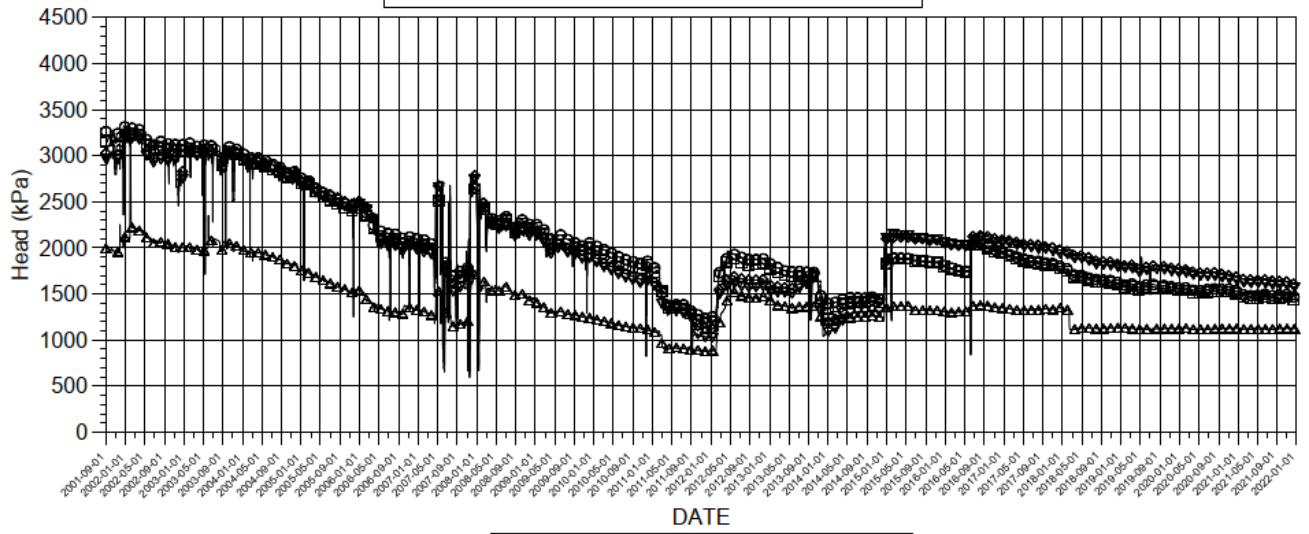

Events	
Start backfilling of section I	2001-09-03
Stop backfilling of section I	2001-11-20
Casting of inner plug finalized	2001-12-19
Start backfilling of section II	2003-04-29
Stop backfilling of section II	2003-06-27
Casting of outer plug finalized	2003-09-11
Packer failure of KA3573A:3	2006-04-18
Start drilling of Fine Sealing Project	2007-03-12
Start grouting of Fine Sealing Project	2007-11-19
Excavation start of TASS tunnel	2007-12-11
Excavation stop of TASS tunnel	2008-12-18
Demolition work start Section II	December 2010
Demolition work Section II finalized	2011-12-15
Replacement of packers Section II	December 2014

Borehole sections	
▼	A01:1 42.5 m - 48.82 m
◆	A01:2 37 m - 41.5 m
□	A01:3 35 m - 36 m
○	A01:4 19 m - 34 m
▲	A01:5 5 m - 18 m

P\_KG0021A01.GRF 2022-10-19



### KG0048A01 PRESSURE HEAD

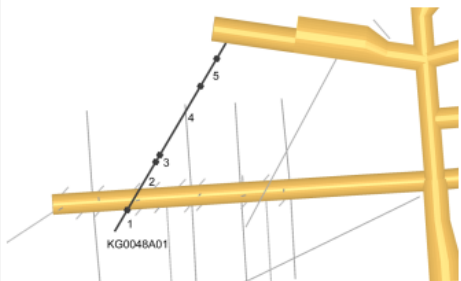
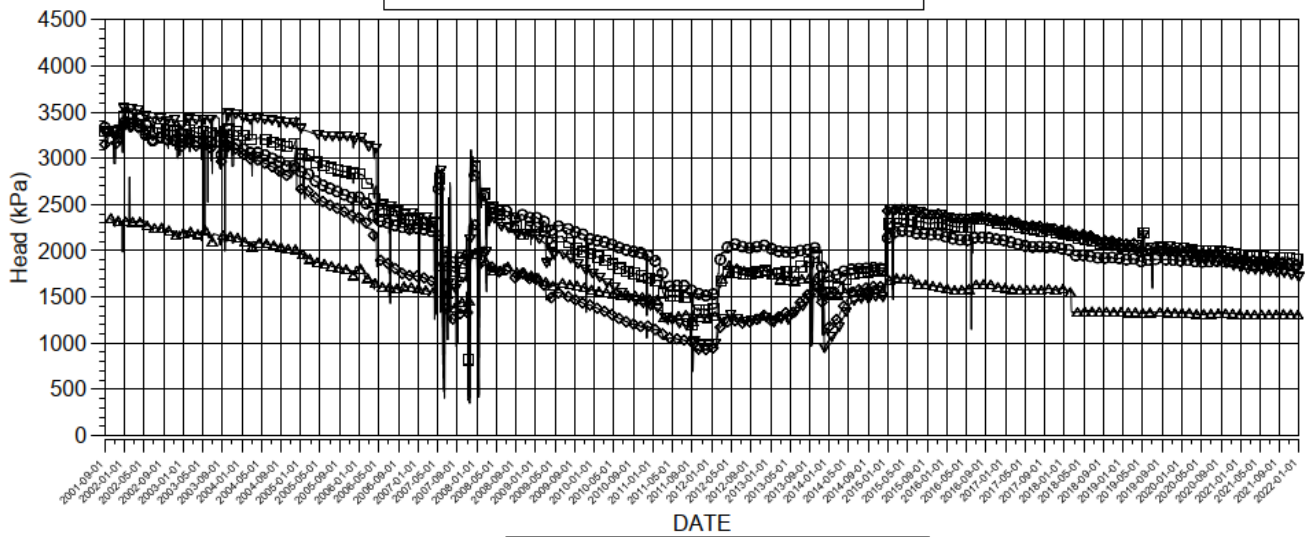

- Events**
- Start backfilling of section I 2001-09-03
  - Stop backfilling of section I 2001-11-20
  - Casting of inner plug finalized 2001-12-19
  - Start backfilling of section II 2003-04-29
  - Stop backfilling of section II 2003-06-27
  - Casting of outer plug finalized 2003-09-11
  - Packer failure of KA3573A:3 2006-04-18
  - Start drilling of Fine Sealing Project 2007-03-12
  - Start grouting of Fine Sealing Project 2007-11-19
  - Excavation start of TASS tunnel 2007-12-11
  - Excavation stop of TASS tunnel 2008-12-18
  - Demolition work start Section II December 2010
  - Demolition work Section II finalized 2011-12-15
  - Replacement of packers Section II December 2014

- Borehole sections**
- ▽ A01:1 49 m - 54.69 m
  - ◇ A01:2 34.8 m - 48 m
  - A01:3 32.8 m - 33.8 m
  - A01:4 13 m - 31.8 m
  - △ A01:5 5 m - 12 m

P\_KG0048A01.GRF 2022-10-19

### MA3411G WEIR FLOW

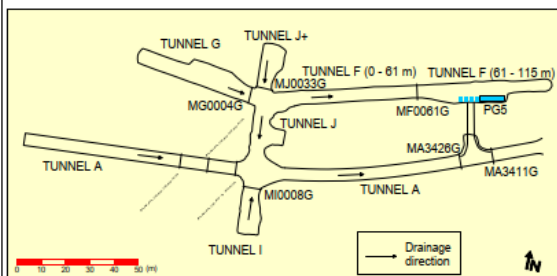
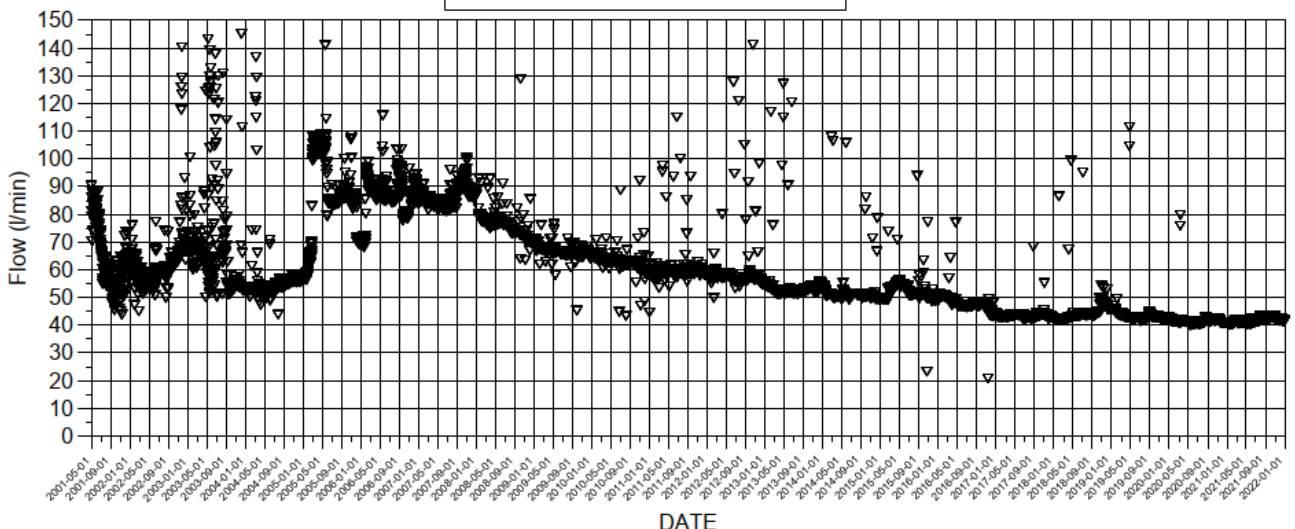

- Events**
- Start backfilling of section I 2001-09-03
  - Stop backfilling of section I 2001-11-20
  - Casting of inner plug finalized 2001-12-19
  - Start backfilling of section II 2003-04-29
  - Stop backfilling of section II 2003-06-27
  - Casting of outer plug finalized 2003-09-11
  - Packer failure of KA3573A:3 2006-04-18
  - Start drilling of Fine Sealing Project 2007-03-12
  - Start grouting of Fine Sealing Project 2007-11-19
  - Excavation start of TASS tunnel 2007-12-11
  - Excavation stop of TASS tunnel 2008-12-18
  - Demolition work start Section II December 2010
  - Demolition work Section II finalized 2011-12-15
  - Replacement of packers Section II December 2014

- ▽ WEIR MA3411G

Q\_MA3411G.GRF 2022-10-20

### MA3426G WEIR FLOW

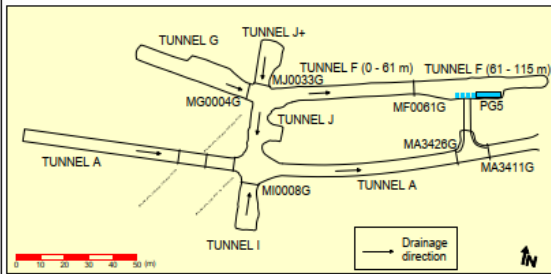
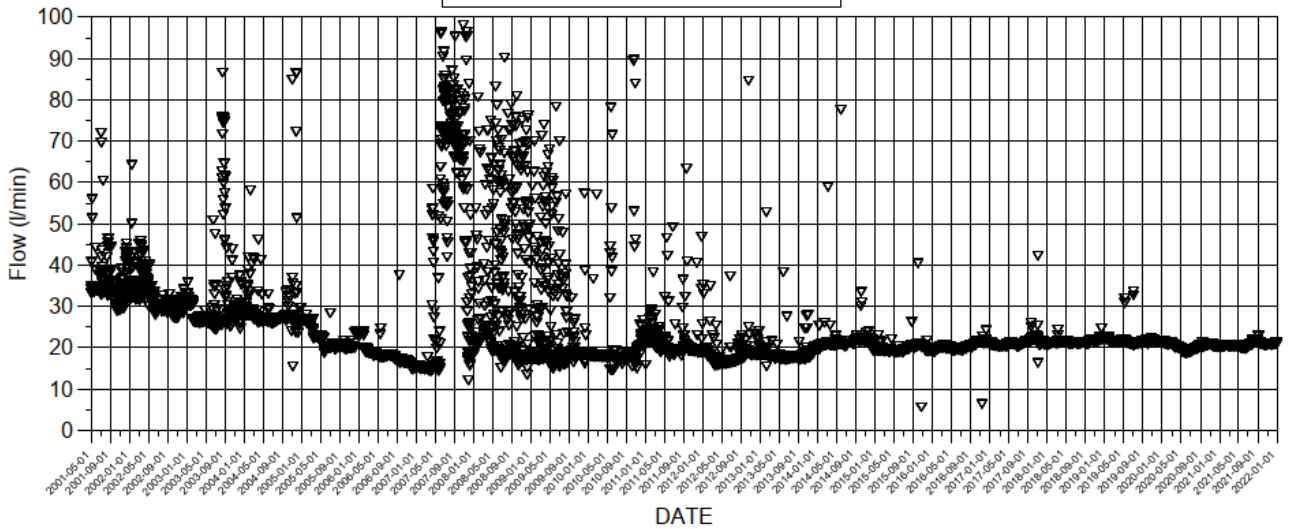

- Events**
- Start backfilling of section I 2001-09-03
  - Stop backfilling of section I 2001-11-20
  - Casting of inner plug finalized 2001-12-19
  - Start backfilling of section II 2003-04-29
  - Stop backfilling of section II 2003-06-27
  - Casting of outer plug finalized 2003-09-11
  - Packer failure of KA3573A:3 2006-04-18
  - Start drilling of Fine Sealing Project 2007-03-12
  - Start grouting of Fine Sealing Project 2007-11-19
  - Excavation start of TASS tunnel 2007-12-11
  - Excavation stop of TASS tunnel 2008-12-18
  - Demolition work start Section II December 2010
  - Demolition work Section II finalized 2011-12-15
  - Replacement of packers Section II December 2014

▽ WEIR MA3426G

Q\_MA3426G.GRF 2022-10-20

### MA3515G WEIR FLOW

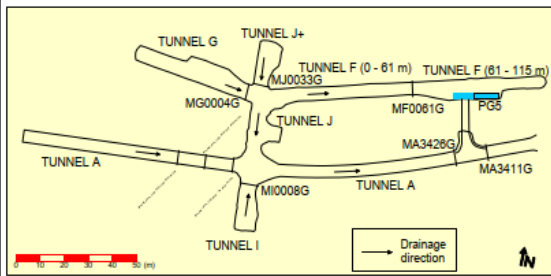
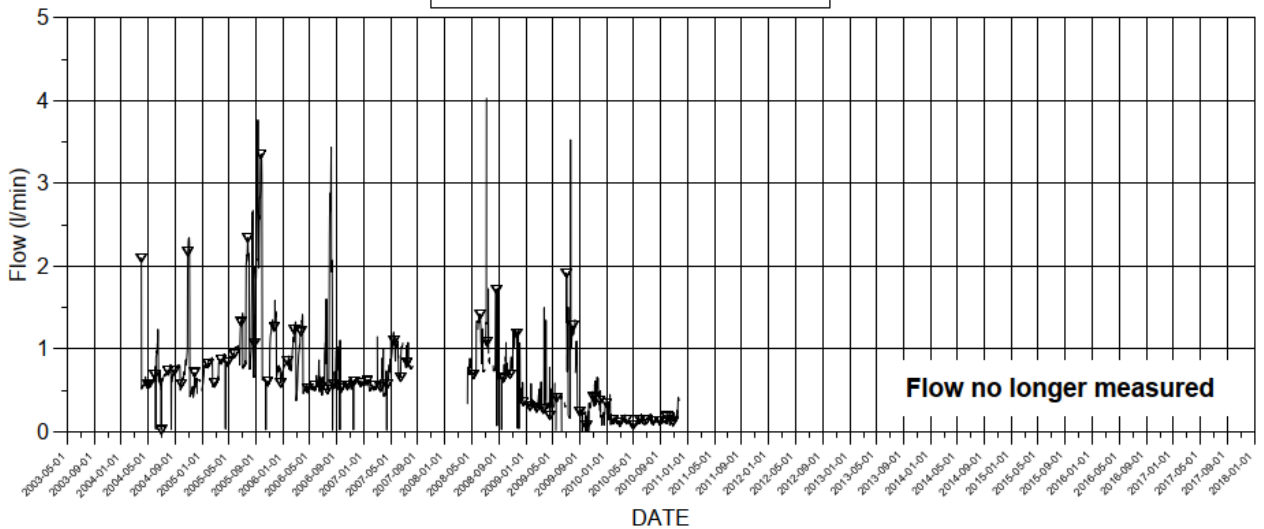

- Events**
- Start backfilling of section I 2001-09-03
  - Stop backfilling of section I 2001-11-20
  - Casting of inner plug finalized 2001-12-19
  - Start backfilling of section II 2003-04-29
  - Stop backfilling of section II 2003-06-27
  - Casting of outer plug finalized 2003-09-11
  - Packer failure of KA3573A:3 2006-04-18
  - Start drilling of Fine Sealing Project 2007-03-12
  - Start grouting of Fine Sealing Project 2007-11-19
  - Excavation start of TASS tunnel 2007-12-11
  - Excavation stop of TASS tunnel 2008-12-18
  - Demolition work start Section II December 2010
  - Demolition work Section II finalized 2011-12-15

▽ WEIR MA3515G

Q\_MA3515G.GRF 2022-10-20



# MA3525G WEIR FLOW

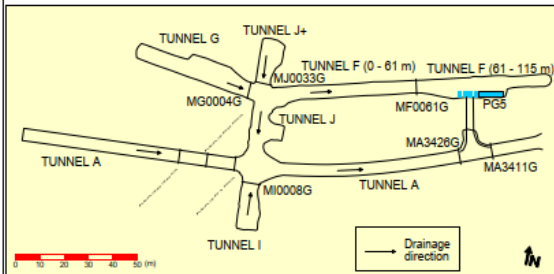
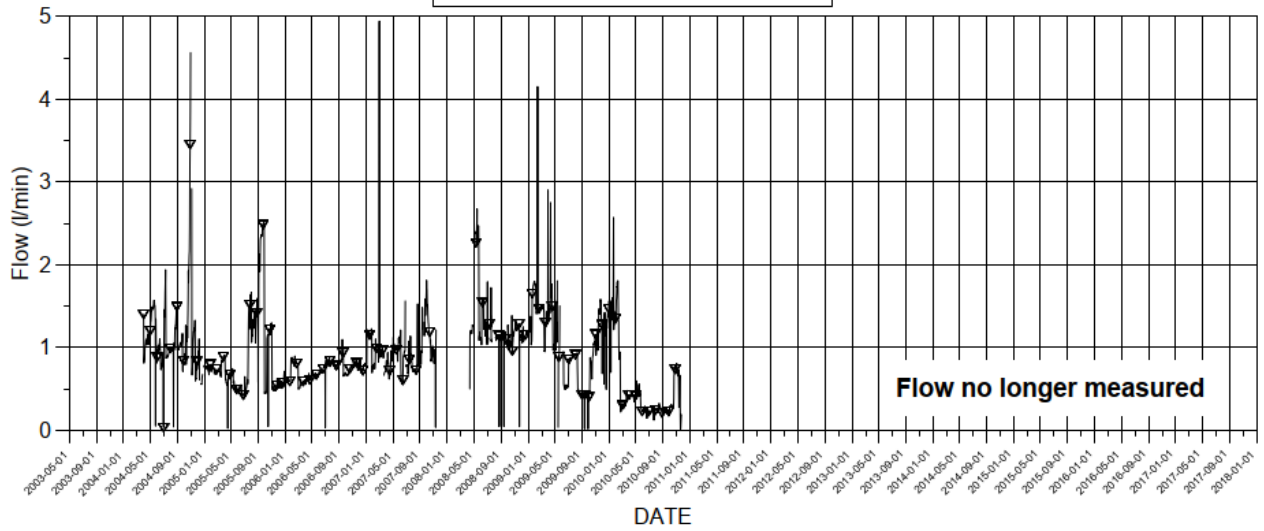

## Events

- Start backfilling of section I 2001-09-03
- Stop backfilling of section I 2001-11-20
- Casting of inner plug finalized 2001-12-19
- Start backfilling of section II 2003-04-29
- Stop backfilling of section II 2003-06-27
- Casting of outer plug finalized 2003-09-11
- Packer failure of KA3573A:3 2006-04-18
- Start drilling of Fine Sealing Project 2007-03-12
- Start grouting of Fine Sealing Project 2007-11-19
- Excavation start of TASS tunnel 2007-12-11
- Excavation stop of TASS tunnel 2008-12-18
- Demolition work start Section II December 2010
- Demolition work Section II finalized 2011-12-15



### MA3535G WEIR FLOW

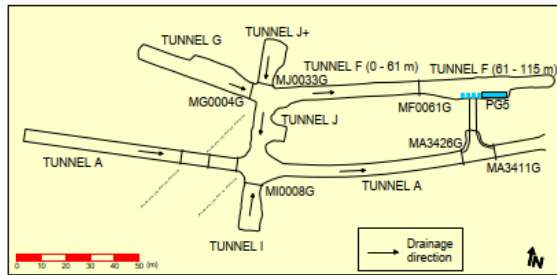
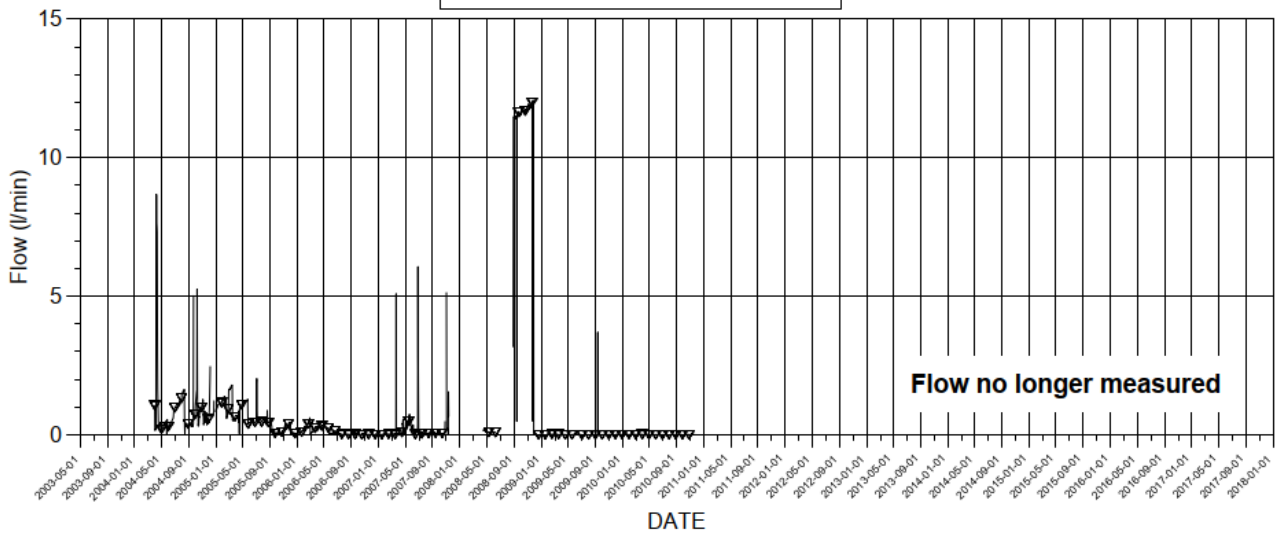

#### Events

- Start backfilling of section I 2001-09-03
- Stop backfilling of section I 2001-11-20
- Casting of inner plug finalized 2001-12-19
- Start backfilling of section II 2003-04-29
- Stop backfilling of section II 2003-06-27
- Casting of outer plug finalized 2003-09-11
- Packer failure of KA3573A:3 2006-04-18
- Start drilling of Fine Sealing Project 2007-03-12
- Start grouting of Fine Sealing Project 2007-11-19
- Excavation start of TASS tunnel 2007-12-11
- Excavation stop of TASS tunnel 2008-12-18
- Demolition work start Section II December 2010
- Demolition work Section II finalized 2011-12-15

▽ WEIR MA3535G

Q\_MA3535G.GRF 2022-10-20

### MF0061G WEIR FLOW

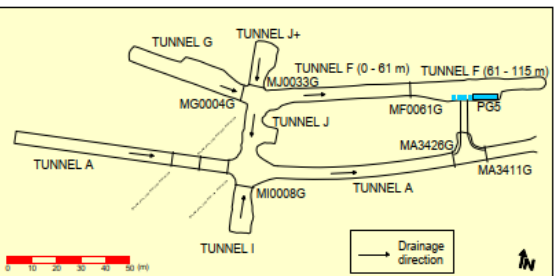
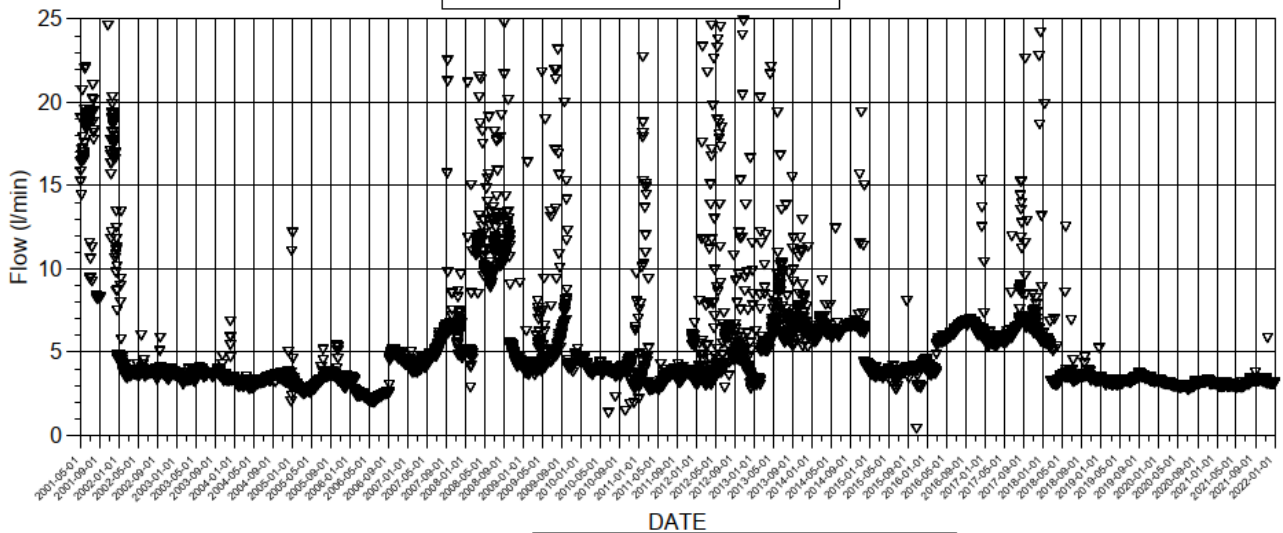

#### Events

- Start backfilling of section I 2001-09-03
- Stop backfilling of section I 2001-11-20
- Casting of inner plug finalized 2001-12-19
- Start backfilling of section II 2003-04-29
- Stop backfilling of section II 2003-06-27
- Casting of outer plug finalized 2003-09-11
- Packer failure of KA3573A:3 2006-04-18
- Start drilling of Fine Sealing Project 2007-03-12
- Start grouting of Fine Sealing Project 2007-11-19
- Excavation start of TASS tunnel 2007-12-11
- Excavation stop of TASS tunnel 2008-12-18
- Demolition work start Section II December 2010
- Demolition work Section II finalized 2011-12-15
- Replacement of packers Section II December 2014

▽ WEIR MF0061G

Q\_MF0061G.GRF 2022-10-20

### MG0004G WEIR FLOW

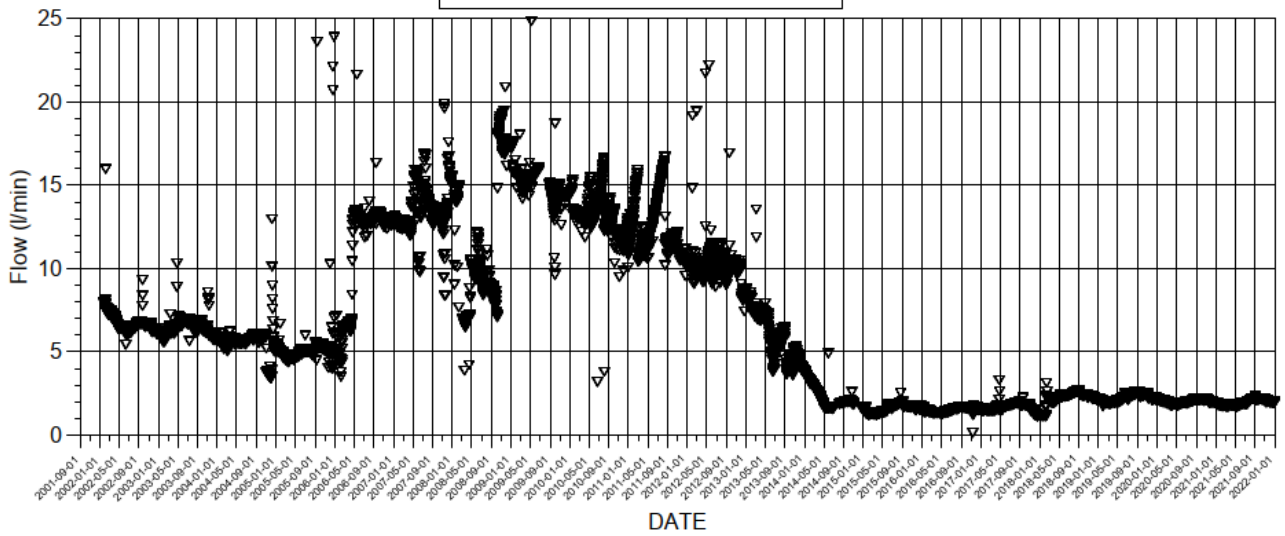

- Events**
- Start backfilling of section I 2001-09-03
  - Stop backfilling of section I 2001-11-20
  - Casting of inner plug finalized 2001-12-19
  - Start backfilling of section II 2003-04-29
  - Stop backfilling of section II 2003-06-27
  - Casting of outer plug finalized 2003-09-11
  - Packer failure of KA3573A:3 2006-04-18
  - Start drilling of Fine Sealing Project 2007-03-12
  - Start grouting of Fine Sealing Project 2007-11-19
  - Excavation start of TASS tunnel 2007-12-11
  - Excavation stop of TASS tunnel 2008-12-18
  - Demolition work start Section II December 2010
  - Demolition work Section II finalized 2011-12-15
  - Replacement of packers Section II December 2014

▽ WEIR MG0004G

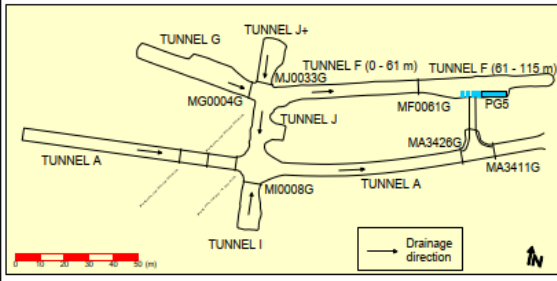

Q\_MG0004G.GRF 2022-10-20

### MI0008G WEIR FLOW

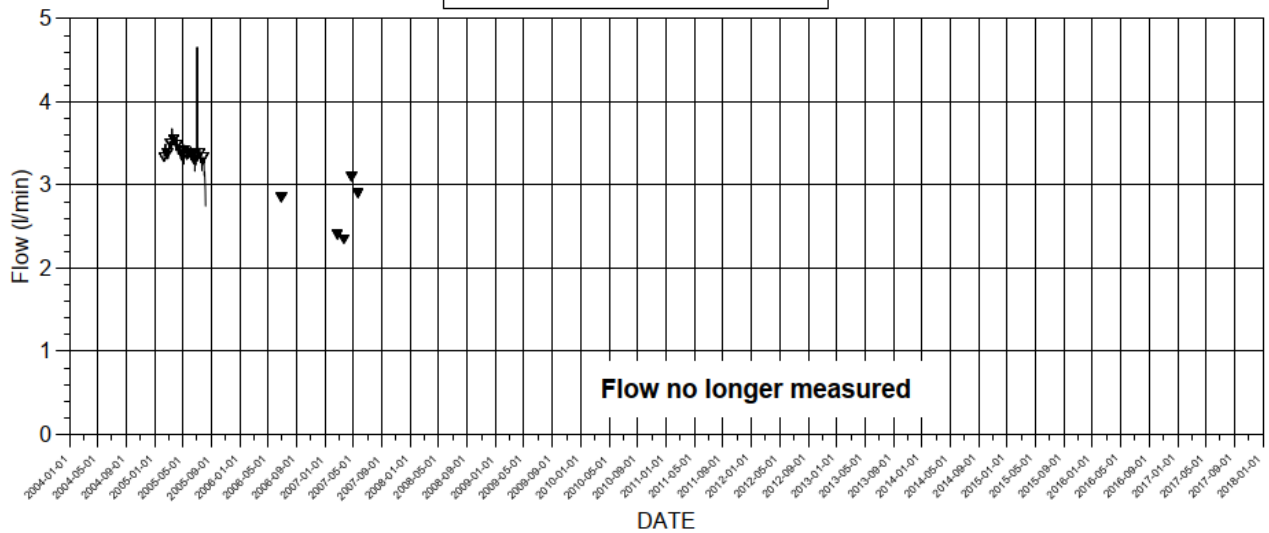

- Events**
- Start backfilling of section I 2001-09-03
  - Stop backfilling of section I 2001-11-20
  - Casting of inner plug finalized 2001-12-19
  - Start backfilling of section II 2003-04-29
  - Stop backfilling of section II 2003-06-27
  - Casting of outer plug finalized 2003-09-11
  - Packer failure of KA3573A:3 2006-04-18
  - Start drilling of Fine Sealing Project 2007-03-12
  - Start grouting of Fine Sealing Project 2007-11-19
  - Excavation start of TASS tunnel 2007-12-11
  - Excavation stop of TASS tunnel 2008-12-18
  - Demolition work start Section II December 2010
  - Demolition work Section II finalized 2011-12-15

▽ WEIR MI0008G  
 ▼ Manual readings

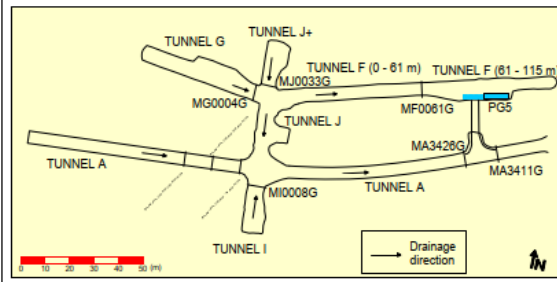

Q\_MI0008G.GRF 2022-10-20

## MJ0033G WEIR FLOW

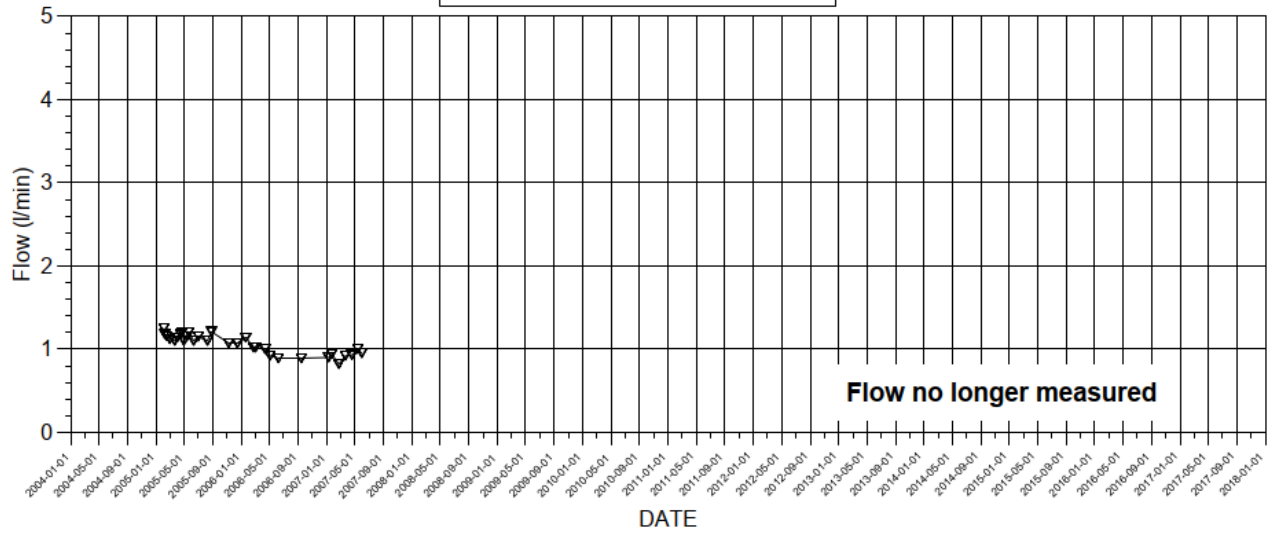

Flow no longer measured

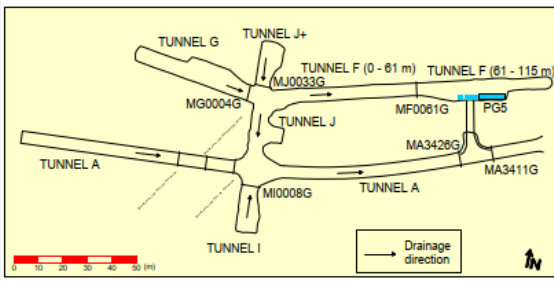

### Events

- Start backfilling of section I 2001-09-03
- Stop backfilling of section I 2001-11-20
- Casting of inner plug finalized 2001-12-19
- Start backfilling of section II 2003-04-29
- Stop backfilling of section II 2003-06-27
- Casting of outer plug finalized 2003-09-11
- Packer failure of KA3573A:3 2006-04-18
- Start drilling of Fine Sealing Project 2007-03-12
- Start grouting of Fine Sealing Project 2007-11-19
- Excavation start of TASS tunnel 2007-12-11
- Excavation stop of TASS tunnel 2008-12-18
- Demolition work start Section II December 2010
- Demolition work Section II finalized 2011-12-15

↘ ↙ WEIR MJ0033G

# MS0010G01 WEIR FLOW

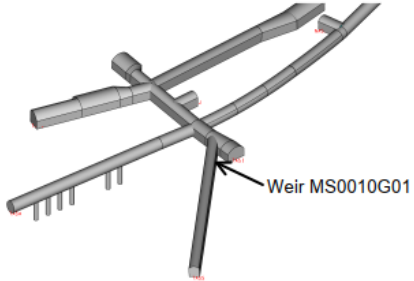
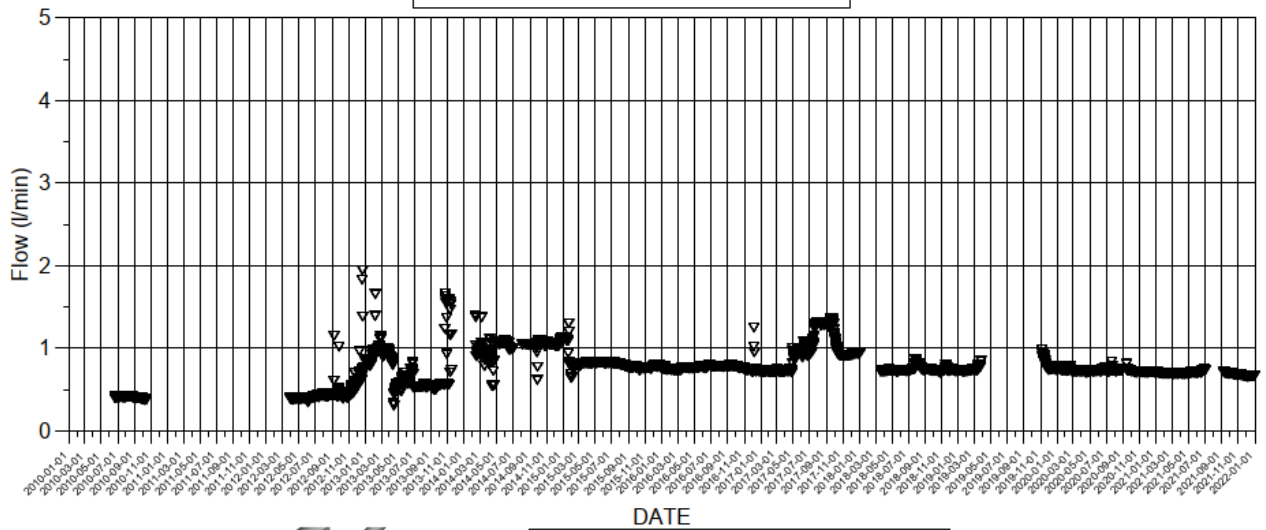

- Events**
- Start backfilling of section I 2001-09-03
  - Stop backfilling of section I 2001-11-20
  - Casting of inner plug finalized 2001-12-19
  - Start backfilling of section II 2003-04-29
  - Stop backfilling of section II 2003-06-27
  - Casting of outer plug finalized 2003-09-11
  - Packer failure of KA3573A:3 2006-04-18
  - Start drilling of Fine Sealing Project 2007-03-12
  - Start grouting of Fine Sealing Project 2007-11-19
  - Excavation start of TASS tunnel 2007-12-11
  - Excavation stop of TASS tunnel 2008-12-18
  - Demolition work start Section II December 2010
  - Demolition work Section II finalized 2011-12-15
  - Replacement of packers Section II 2014

▼ WEIR MS0010G01

### MS0033G01 WEIR FLOW

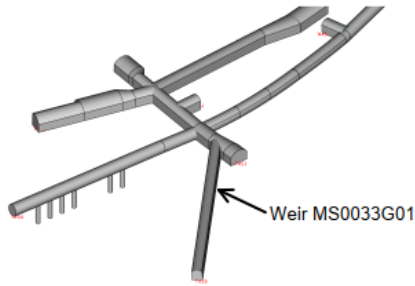
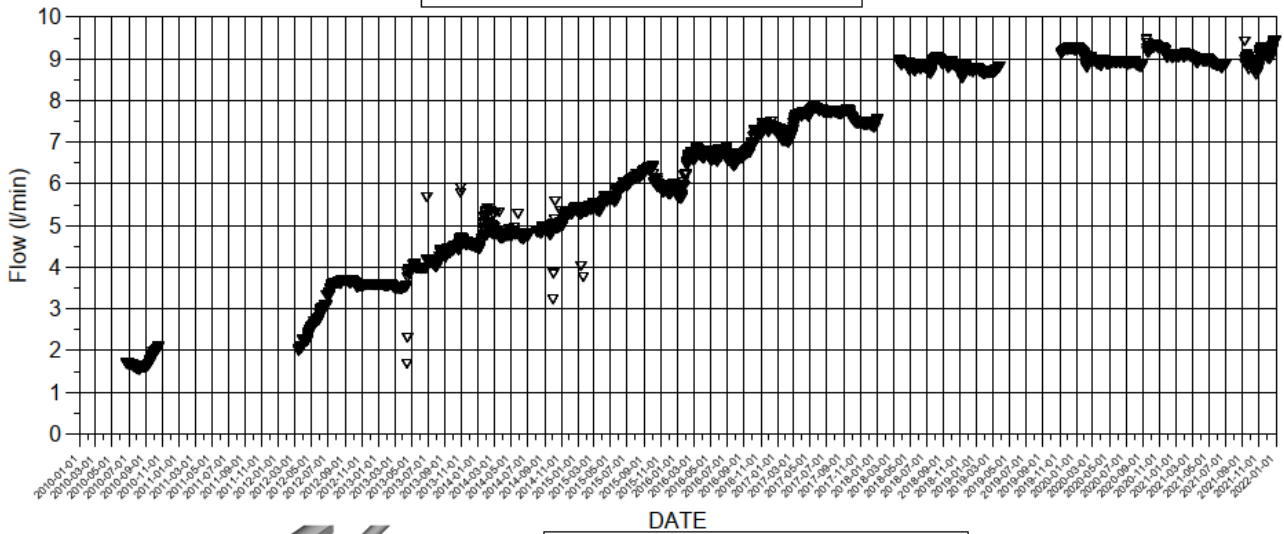

#### Events

- Start backfilling of section I 2001-09-03
- Stop backfilling of section I 2001-11-20
- Casting of inner plug finalized 2001-12-19
- Start backfilling of section II 2003-04-29
- Stop backfilling of section II 2003-06-27
- Casting of outer plug finalized 2003-09-11
- Packer failure of KA3573A:3 2006-04-18
- Start drilling of Fine Sealing Project 2007-03-12
- Start grouting of Fine Sealing Project 2007-11-19
- Excavation start of TASS tunnel 2007-12-11
- Excavation stop of TASS tunnel 2008-12-18
- Demolition work start Section II December 2010
- Demolition work Section II finalized 2011-12-15
- Replacement of packers Section II December 2014

▼ WEIR MS0033G01

Q\_MS0033G01.GRF 2022-10-20

### MS0050G01 WEIR FLOW

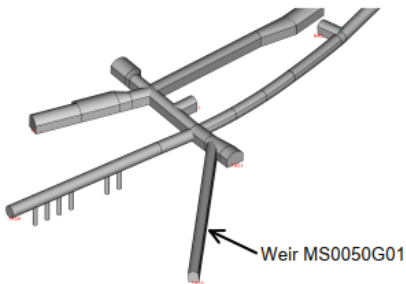
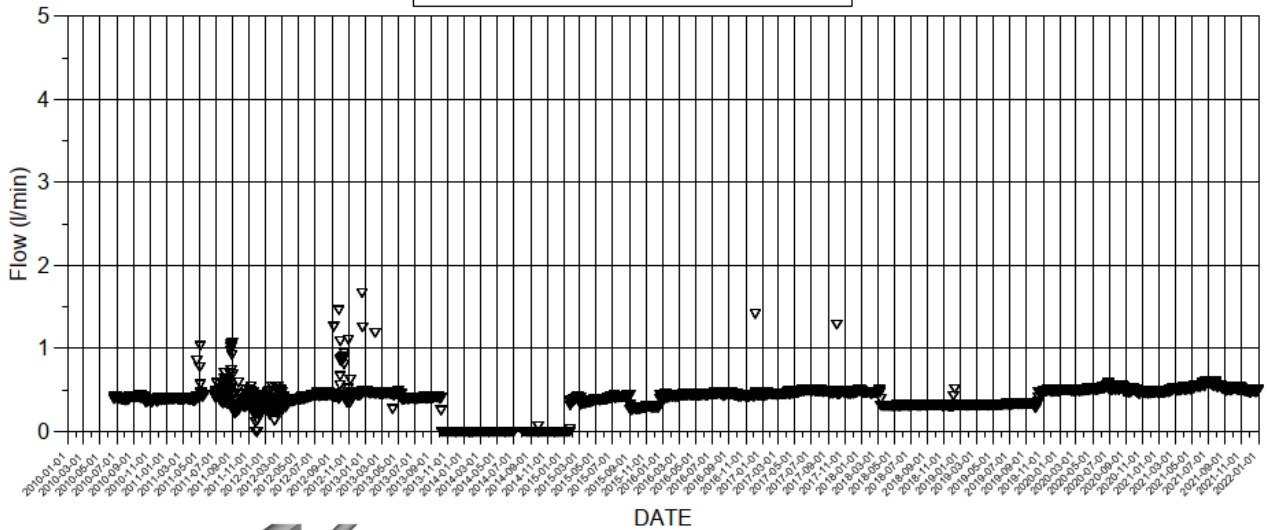

#### Events

- Start backfilling of section I 2001-09-03
- Stop backfilling of section I 2001-11-20
- Casting of inner plug finalized 2001-12-19
- Start backfilling of section II 2003-04-29
- Stop backfilling of section II 2003-06-27
- Casting of outer plug finalized 2003-09-11
- Packer failure of KA3573A:3 2006-04-18
- Start drilling of Fine Sealing Project 2007-03-12
- Start grouting of Fine Sealing Project 2007-11-19
- Excavation start of TASS tunnel 2007-12-11
- Excavation stop of TASS tunnel 2008-12-18
- Demolition work start Section II December 2010
- Demolition work Section II finalized 2011-12-15
- Replacement of packers Section II December 2014

▼ WEIR MS0050G01

Q\_MS0050G01.GRF 2022-10-20