

# Technical Report

## TR-14-01

Revised edition

### **Safety analysis for SFR**

### **Long-term safety**

### **Main report for the safety**

### **assessment SR-PSU**

Svensk Kärnbränslehantering AB

October 2015

**Svensk Kärnbränslehantering AB**

Swedish Nuclear Fuel  
and Waste Management Co

Box 250, SE-101 24 Stockholm  
Phone +46 8 459 84 00





ISSN 1404-0344

SKB TR-14-01

ID 1420718

Revised edition

Updated 2017-04

# **Safety analysis for SFR**

## **Long-term safety**

### **Main report for the safety assessment SR-PSU**

Svensk Kärnbränslehantering AB

October 2015

*Keywords:* Safety assessment, Long-term safety, Final repository,  
Low- and intermediate-level radioactive waste, Forsmark.

A pdf version of this document can be downloaded from [www.skb.se](http://www.skb.se).

## Update notice

The original report, dated October 2015, was found to contain factual errors which have been corrected in this updated version. The corrected factual errors are presented below

### Updated 2017-04

Location	Original text	Corrected text
Page 20, Figure S-4	<i>Text and arrows missing</i>	Figure S-4 updated with text and arrows.
Page 70, Section 3.5.3, last paragraph, line 6	...one of the four FHA scenarios...	...one of the three FHA scenarios...
Page 158, Table 6-5, row 2, column 1BTF	3,000	4,000
Page 165, end of Paragraph 4, last line	...materials (Moreno et al. 2001)	...materials (Rout et al. 2014, Askarieh et al. 2000)
Page 236, Section 7.6.6, last paragraph, sentence 2	Except for Pb/Pd and Ag this factor was chosen because reduction factors will increase by a factor of 10 with each 10-fold increase in the concentration of complexing agent above the indicated no-effect level in the Data report.	For all radionuclides that are potentially affected by complexing agents (i.e. all ions but C, Ca, Cl, I, Cs and Mo) this factor was chosen because reduction factors will increase by a factor of 10 with each 10-fold increase in the concentration of complexing agent above the indicated no-effect level in the Data report.
Page 378, References	<i>New reference</i>	Rout S P, Radford J, Laws A P, Sweeney F, Elmekawy A, Gillie L J, Humphreys P N, 2014. Biodegradation of the alkaline cellulose degradation products generated during radioactive waste disposal. PLoS One 9. doi:e107433. doi:10.1371/journal.pone.0107433
Page 390, References	Strömgren et al. 2013	<i>Reference removed</i>
Page 494, Table F-11, Landscape modelling, column 4	Strömgren et al. 2013	Sohlenius et al. 2013a

## Preface

This document is the main report of the SR-PSU, an assessment of the long-term safety for the SFR repository. SFR is a repository for short-lived low- and intermediate-level radioactive wastes located in Forsmark in the municipality of Östhammar in Sweden. This report is a revised edition compared to the report published in December 2014. The revised edition corresponds to the Swedish report 'Redovisning av säkerhet efter förslutning för SFR, Huvudrapport för säkerhetsanalysen SR-PSU' which is a document that supports SKB's applications for licences to extend the SFR repository. In the revised edition results from an updated inventory of Mo-93 have been included as well as other minor corrections.

Fredrik Vahlund, the project manager for the safety assessment SR-PSU, is responsible for the analysis and the first version of the report. Eva Andersson is the project manager in the licensing phase of SR-PSU (starting January 2015) and answer for this revised edition of the report.

The SR-PSU project group has had a central and co-ordinating role in the work with the safety assessment and this report. This group consist of: Mikael Asperö (Kemakta Konsult AB), Jenny Brandefelt (SKB), Olle Broman (Ekonomisk Byggnation AB), Christina Greis Dahlberg (SKB), Thomas Hjerpe (Facilia AB), Sven Keesmann (SKB), Klas Källström (SKB), Maria Lindgren (Kemakta Konsult AB), Martin Löfgren (Niressa AB), Teresita Morales (SKB), Jens Morell (Vattenfall Research and Development AB), Ann-Mari Nisula (A-M Konsult), Jens-Ove Näslund (SKB), Magnus Odén (SKB), Peter Saetre (SKB), Patrik Sellin (SKB), Kristina Skagius (SKB), Ola Wessely (SKB), Marie Wiborgh (Kemakta Konsult AB) and Per-Gustav Åstrand (Facilia AB).

A large number of other persons, too many to be mentioned here, are also acknowledged for contributing to the safety assessment, supporting documents, and this report. SKB would also like to thank the following persons for their valuable support and contributions to the review process: Jordi Bruno, Amphos 21 Consulting Ltd; Russell Alexander, Bedrock Geosciences; Mike Thorne, Mike Thorne Ltd; Tommy Olsson, I&T Olsson AB; Luc van Loon, PSI; Derek Martin University of Alberta; Allan Geoffrey Milnes, GEA Consulting; Kastriot Spahiu, Allan Hedin, Björn Söderbäck, Peter Wikberg, Johan Andersson, Börje Torstenfelt and Olle Olsson, SKB.

Stockholm, August 2015



Fredrik Vahlund



Eva Andersson



# Contents

<b>Summary</b>	11
S1 Purpose and general prerequisites	11
S2 Post-closure safety	14
S2.1 Safety principles	14
S2.2 The repository design	14
S3 Analysing safety – the safety assessment	15
S4 Conclusions of the SR-PSU assessment	22
S4.1 Demonstration of compliance	22
S4.2 Requirements and constraints	23
S4.3 Need for further RD&D	24
<b>1 Introduction</b>	25
1.1 Background	25
1.1.1 SKB's system for waste disposal	25
1.2 SFR	26
1.3 Waste to be disposed in SFR	28
1.3.1 Classification of nuclear waste	28
1.3.2 General description	29
1.3.3 Activity and radiotoxicity of the waste	30
1.4 Regulations in relation to safety assessment	32
1.5 This safety assessment	32
1.6 Report structure	33
<b>2 Methodology</b>	35
2.1 Introduction	35
2.1.1 Post-closure safety	35
2.1.2 Post-closure safety principles	35
2.2 Regulatory requirements	36
2.2.1 Time period to be covered by the assessment	36
2.2.2 Analysis of compliance	37
2.2.3 Methodological considerations for the execution of the assessment	37
2.2.4 Design and best available technique	38
2.3 Safety assessment	38
2.3.1 Timescale for the assessment	39
2.3.2 Approach to show compliance	41
2.3.3 Methodological considerations	42
2.3.4 BAT and optimisation	44
2.4 Methodology in ten steps	44
2.4.1 Step 1: Handling of FEPs	44
2.4.2 Step 2: Description of initial state	45
2.4.3 Step 3: Description of external conditions	46
2.4.4 Step 4: Description of internal processes	46
2.4.5 Step 5: Definition of safety functions	47
2.4.6 Step 6: Compilation of input data	47
2.4.7 Step 7: Analysis of reference evolution	47
2.4.8 Step 8: Selection of scenarios	48
2.4.9 Step 9: Analysis of selected scenarios	48
2.4.10 Step 10: Conclusions	49
2.5 Report hierarchy in the SR-PSU safety assessment	49
2.6 Uncertainties	51
2.6.1 Regulatory requirements	51
2.6.2 Handling of uncertainties in the present analysis	52
2.7 Documentation and quality assurance	53

<b>3</b>	<b>Handling of FEPs</b>	55
3.1	Introduction	55
3.2	Methodology for handling FEPs	55
3.2.1	SKB's FEP database	55
3.2.2	FEP catalogue for SR-PSU	55
3.2.3	Couplings	58
3.2.4	Summary of the methodology for handling FEPs	61
3.3	Initial state FEPs	62
3.4	Handling of internal processes	62
3.4.1	Format for the process documentation	63
3.4.2	Summary of handling of internal processes	66
3.4.3	Assessment Model Flowchart, AMF	66
3.5	Handling of external conditions	66
3.5.1	Climate-related issues	67
3.5.2	Large-scale geological processes and effects	70
3.5.3	Future human actions	70
<b>4</b>	<b>Initial state in the repository and its environs</b>	73
4.1	Introduction	73
4.1.1	Inspection and control	74
4.2	Waste	74
4.2.1	Origin of the waste	74
4.2.2	Material types	75
4.2.3	Waste packaging	76
4.2.4	Waste volumes, material quantities and radionuclide inventory	77
4.3	Repository	83
4.3.1	1BMA, vault for intermediate-level waste	85
4.3.2	2BMA, vault for intermediate-level waste	87
4.3.3	1BTF and 2BTF, vaults for concrete tanks	89
4.3.4	Silo	93
4.3.5	1BLA, vault for low-level waste	96
4.3.6	2-5BLA, vaults for low-level waste	98
4.3.7	BRT, vault for reactor pressure vessels	100
4.3.8	Plugs and other closure components	102
4.4	Climate	104
4.4.1	Temperature and precipitation	104
4.4.2	Shoreline displacement	104
4.5	Surface systems	105
4.5.1	Topography and regolith	105
4.5.2	Meteorology, hydrology, near-surface hydrogeology and water chemistry	109
4.5.3	Marine ecosystems	112
4.5.4	Limnic ecosystems	112
4.5.5	Terrestrial ecosystems	114
4.5.6	Wells and water resources management	115
4.5.7	Human population and land use	115
4.6	Bedrock	115
4.6.1	Bedrock temperature	115
4.6.2	Rock types and rock domains	116
4.6.3	Deformation zones and subhorizontal superficial structures	116
4.6.4	Rock mechanical conditions	118
4.7	Hydrogeology	119
4.7.1	Hydraulic conductivity of the rock	119
4.7.2	Groundwater inflow	121
4.8	Groundwater chemistry	122
4.8.1	Present groundwater composition and their origins	122
4.8.2	Groundwater types in the area for SFR 3	126
4.8.3	Changes in water composition caused by drawdown in SFR	126
4.8.4	Water composition in the initial state	126



<b>5</b>	<b>Safety functions</b>	129
5.1	Safety functions as a basis for scenario description	130
5.2	Method for selecting safety functions	130
	5.2.1 Repository components and their functions	130
5.3	Limitation of the activity of long-lived radionuclides	131
	5.3.1 Allocation of waste to and distribution within the repository	132
5.4	Retention of radionuclides	132
	5.4.1 Function of waste and packaging	132
	5.4.2 Function of the engineered barriers in the vaults	134
	5.4.3 Function of plugs and other closure components	135
	5.4.4 Function of the geosphere	136
	5.4.5 The surface system	136
5.5	Defined safety functions for the assessment	137
5.6	Additional use of safety functions	138
<b>6</b>	<b>Reference evolution</b>	139
6.1	Introduction	139
6.2	External conditions	140
	6.2.1 Timing of climate domains	141
	6.2.2 Shore-level evolution	143
	6.2.3 Potential for permafrost in Forsmark	144
6.3	The first 1,000 years after closure	144
	6.3.1 Evolution of surface systems	144
	6.3.2 Thermal evolution	146
	6.3.3 Mechanical evolution	147
	6.3.4 Hydrogeological evolution	148
	6.3.5 Near-field hydrological evolution	150
	6.3.6 Geochemical evolution	151
	6.3.7 Chemical evolution of the waste	153
	6.3.8 Evolution of engineered barriers	167
6.4	Periods of temperate climate domain more than 1,000 years after closure	177
	6.4.1 Evolution of surface systems	177
	6.4.2 Thermal evolution	182
	6.4.3 Mechanical evolution	182
	6.4.4 Hydrogeological evolution	182
	6.4.5 Near-field hydrological evolution	183
	6.4.6 Geochemical evolution	188
	6.4.7 Chemical evolution of the waste	188
	6.4.8 Evolution of engineered barriers	192
6.5	Periods of periglacial climate domain more than 1,000 years after closure	196
	6.5.1 Evolution of surface systems	196
	6.5.2 Thermal evolution	197
	6.5.3 Mechanical evolution	198
	6.5.4 Hydrogeological evolution	198
	6.5.5 Near-field hydrological evolution	199
	6.5.6 Geochemical evolution	200
	6.5.7 Chemical evolution of the waste domain	201
	6.5.8 Evolution of engineered barriers	202
6.6	Summary of the reference evolution	202
	6.6.1 At 1,000 years after closure	203
	6.6.2 At the time for possible early periglacial conditions around 17,500 AD	204
	6.6.3 At the time for periglacial conditions around 52,000 AD	205
	6.6.4 At the end of the assessment period	205
<b>7</b>	<b>Selection of scenarios</b>	207
7.1	Introduction	207
7.2	Regulatory requirements – Scenario selection	207
7.3	Method for scenario selection	208

7.3.1	The main scenario	208
7.3.2	Less probable scenarios	209
7.3.3	Residual scenarios	209
7.3.4	Combinations of scenarios	209
7.4	Main scenario	209
7.4.1	External conditions	209
7.4.2	Geosphere	211
7.4.3	Repository	215
7.4.4	Surface systems	220
7.4.5	Exposure of humans and non-human biota	221
7.4.6	Safety functions in the main scenario	224
7.5	Selection of less probable scenarios	227
7.5.1	Routes to violation of the safety function limited quantity of activity	227
7.5.2	Routes to violation of the safety function low flow in the bedrock	227
7.5.3	Routes to violation of the safety function low flow in waste vaults	228
7.5.4	Routes to violation of the safety function good retention	229
7.5.5	Routes to violation of the safety function avoid wells in direct vicinity of the repository	230
7.6	Description of less probable scenarios	231
7.6.1	High inventory scenario	231
7.6.2	High flow in the bedrock scenario	232
7.6.3	Accelerated concrete degradation scenario	233
7.6.4	Bentonite degradation scenario	234
7.6.5	Earthquake scenario	235
7.6.6	High concentrations of complexing agents scenario	236
7.6.7	Wells downstream of the repository scenario	237
7.6.8	Intrusion wells scenario	237
7.7	Residual scenarios	238
7.7.1	Loss of barrier function scenario – no sorption in the repository	238
7.7.2	Loss of barrier function scenario – no sorption in the bedrock	238
7.7.3	Loss of barrier function scenario – high water flow in the repository	238
7.7.4	Changed repository redox conditions in SFR 1 scenario	238
7.7.5	Extended global warming scenario	240
7.7.6	Unclosed repository scenario	240
7.7.7	Future human action scenarios	241
7.7.8	Glaciation and post-glacial conditions scenario	243
7.8	Scenario combinations	246
7.9	Summary of selected scenarios	246
<b>8</b>	<b>Description of calculation cases</b>	<b>249</b>
8.1	Introduction	249
8.2	Modelling approach	249
8.2.1	Model chain and data flow	249
8.2.2	Safety relevant radionuclides	252
8.2.3	Near-field	254
8.2.4	Far-field	264
8.2.5	Biosphere	264
8.3	Calculation cases in the main scenario	270
8.3.1	Global warming calculation case (CCM_GW)	270
8.3.2	Early periglacial calculation case (CCM_EP)	273
8.3.3	Timing of the releases calculation case (CCM_TR)	273
8.3.4	Collective dose (CCM_CD)	274
8.4	Calculation cases for less probable scenarios	274
8.4.1	High inventory calculation case (CCL_IH)	274
8.4.2	High flow in the bedrock calculation case (CCL_FH)	275
8.4.3	Accelerated concrete degradation calculation case (CCL_BC)	275
8.4.4	Bentonite degradation calculation case (CCL_BB)	275
8.4.5	Earthquake calculation case (CCL_EQ)	275

8.4.6	High concentrations of complexing agents calculation case (CCL_CA)	275
8.4.7	Wells downstream of the repository calculation case (CCL_WD)	276
8.4.8	Intrusion wells calculation case (CCL_WI)	276
8.5	Calculation cases for residual scenarios	276
8.5.1	Loss of barrier function calculation case – no sorption in the repository (CCR_B1)	276
8.5.2	Loss of barrier function calculation case – no sorption in the bedrock (CCR_B2)	277
8.5.3	Loss of barrier function calculation case – high water flow in the repository (CCR_B3)	277
8.5.4	Changed repository redox conditions in SFR 1 calculation case (CCR_RX)	277
8.5.5	Extended global warming calculation case (CCR_EX)	277
8.5.6	Unclosed repository calculation case (CCR_UR)	277
8.5.7	Cases related to future human action	278
8.5.8	Glaciation and post-glacial conditions calculation case (CCR_GC)	279
8.6	Calculation cases for scenario combinations	280
8.6.1	Scenario combination 1 (CCC_SC1)	280
8.6.2	Scenario combination 2 (CCC_SC2)	280
8.7	Summary	280
<b>9</b>	<b>Radionuclide transport and dose calculations</b>	<b>285</b>
9.1	Introduction	285
9.2	Results for the main scenario	286
9.2.1	Global warming variant of the main scenario	286
9.2.2	Early periglacial variant of the main scenario	293
9.2.3	Collective dose	294
9.3	Results for the less probable scenarios	295
9.3.1	High inventory scenario	295
9.3.2	High flow in the bedrock scenario	300
9.3.3	Accelerated concrete degradation scenario	303
9.3.4	Bentonite degradation scenario	307
9.3.5	Earthquake scenario	308
9.3.6	High concentrations of complexing agents scenario	309
9.3.7	Wells downstream of the repository scenario	314
9.3.8	Intrusion wells scenario	317
9.4	Results for the residual scenarios	319
9.4.1	Loss of barrier function scenario – no sorption in the repository	319
9.4.2	Loss of barrier function scenario – no sorption in the bedrock	319
9.4.3	Loss of barrier function scenario – high water flow in the repository	320
9.4.4	Changed repository redox conditions in SFR 1 scenario	320
9.4.5	Extended global warming scenario	321
9.4.6	Unclosed repository scenario	322
9.4.7	Scenarios related to future human actions (FHA)	322
9.4.8	Glacial and post-glacial conditions scenario	325
9.5	Results for scenario combinations	325
9.5.1	Scenario combination 1	325
9.5.2	Scenario combination 2	326
9.6	Summary of peak doses to humans	327
9.7	Dose rates to non-human biota	328
9.7.1	Global warming variant of the main scenario	331
9.7.2	Overview of NHB assessment results across all scenarios	333
<b>10</b>	<b>Assessment of risk</b>	<b>335</b>
10.1	Regulatory requirement	336
10.1.1	Protection of human health	336
10.1.2	Protection of the environment	337
10.2	Protection of human health, collective dose	337

10.3	Protection of human health, periods of temperate and periglacial climate domains	338
10.3.1	Radiological risk for the main scenario and each of the less probable scenarios	340
10.3.2	Radiological risks for scenario combinations	342
10.3.3	Total radiological risk	342
10.3.4	Compliance with the radiological risk criterion	342
10.4	Protection of human health, glacial and post-glacial phase	344
10.4.1	Annual dose	344
10.5	Protection of the environment	344
10.6	Additional analysis	345
10.6.1	Contribution to total radiological risk from different waste vaults	345
10.6.2	Contribution to total radiological risk from different radionuclides	346
10.6.3	Risk dilution	357
10.6.4	Additional safety indicators	360
10.7	Conclusion	361
<b>11</b>	<b>Conclusions, further research needs and requirements on design, construction, operation and wastes</b>	<b>363</b>
11.1	Introduction	363
11.2	Conclusions	363
11.2.1	Protection of human health and of the environment	364
11.3	Repository performance	365
11.3.1	Time-scales and waste types	365
11.3.2	Arguments for the selected time-scale of the risk analysis	366
11.3.3	Repository depth	367
11.3.4	Barriers and their functions	367
11.4	The current assessment	370
11.4.1	Initial state	370
11.4.2	External conditions	371
11.4.3	Internal processes	371
11.4.4	Evolution of the repository system	372
11.4.5	Estimating radiological risk	372
11.4.6	Confidence in results	372
11.4.7	Uncertainties	373
11.5	Requirements and the iterative process	373
11.5.1	Analysis of long-term safety	375
11.5.2	Requirements and restrictions	375
11.5.3	Need for further R&D	377
<b>12</b>	<b>References</b>	<b>381</b>
<b>Appendix A</b>	Compliance with requirements from SSMFS 2008:21 in SR-PSU	393
<b>Appendix B</b>	Compliance with requirements from SSMFS 2008:37 in SR-PSU	401
<b>Appendix C</b>	Handling of injunctions from SAR-08	415
<b>Appendix D</b>	Handling of review comments from SAR-08 in SR-PSU	417
<b>Appendix E</b>	Terms and abbreviations	473
<b>Appendix F</b>	Tables related to the handling of FEPs	477
<b>Appendix G</b>	Assessment Model Flowchart, AMF	495
<b>Appendix H</b>	Map of the Forsmark area	497
<b>Appendix I</b>	Requirements on pH and the maximum amount of cellulose in the SFR repository	499

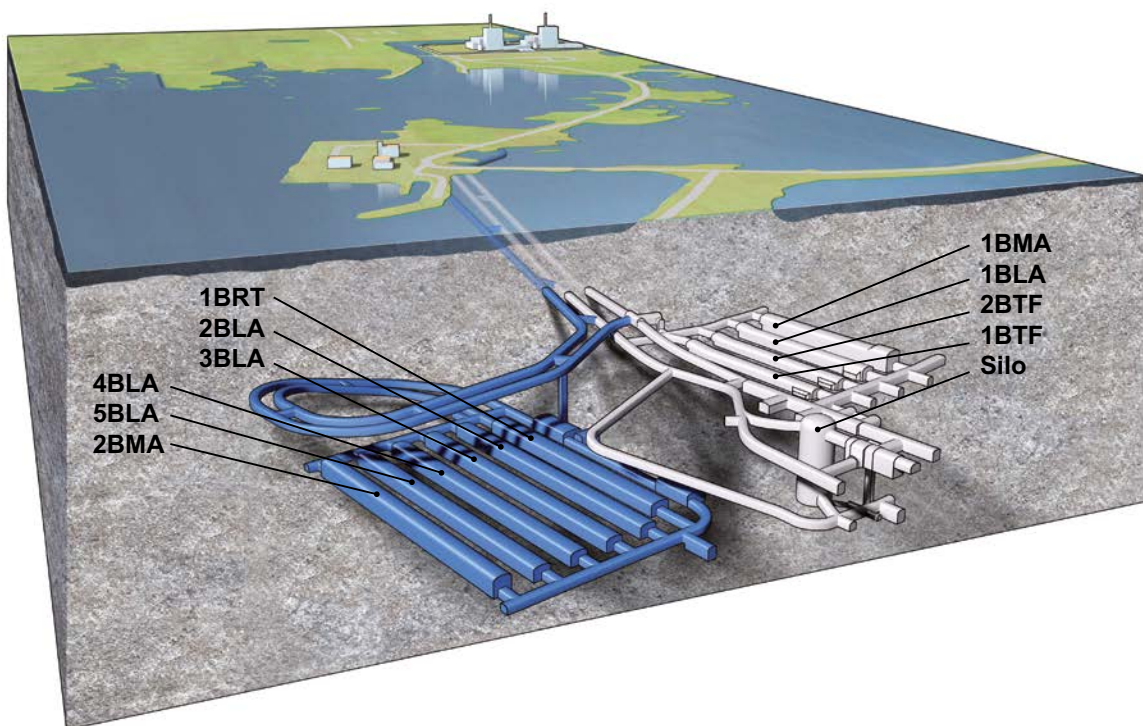
# Summary

The central conclusion of the safety assessment SR-PSU is that the extended SFR repository (SFR 1 and SFR 3) meets regulatory criteria with respect to long-term safety. This conclusion is reached due to the combination of sufficiently limited activity of long-lived radionuclides and sufficient retention of radionuclides in the repository.

## S1 Purpose and general prerequisites

The SR-PSU report is a main component in SKB's licence application to extend SFR. Its role in the application is to demonstrate the long-term (post-closure) safety of the extended SFR repository. This is done by conducting a detailed safety analysis and evaluating the compliance with the Swedish Radiation Safety Authority's regulations concerning safety and protection of human health and the environment in the long-term perspective for the extended SFR repository. In addition to demonstrating long-term safety, the purpose of the present report is also to identify areas where further research and technology development are needed. The report complements SKB's RD&D programme and will help in prioritising further research work.

SFR is a repository for short-lived low- and intermediate-level radioactive wastes that has been in operation since 1988. The repository is located below the Baltic Sea and covered by about 60 metres of granitoid rock. The underground part of the existing facility, SFR 1, consists of four waste vaults, plus a 70-metre-high vault with a concrete silo (see Figure S-1). Today, operational waste from the nuclear power plants and from other nuclear facilities is disposed of in SFR 1.



**Figure S-1.** The existing SFR 1 (light grey) and the extension SFR 3 (blue) with access tunnels. The waste vaults in the figure are the silo for intermediate-level waste, 1 and 2BMA vaults for intermediate-level waste, 1–2BTF vaults for concrete tanks with intermediate-level waste with low activity levels, 1BLA and 2–5BLA vaults for low-level waste and the BRT vault for reactor pressure vessels.

The extension, SFR 3, will be built with a rock cover of about 120 m, i.e. at about the same level as the bottom of the silo. The underground part of SFR 3 will consist of six new waste vaults. Additional operational waste and the waste from decommissioning of the Swedish nuclear power plants and other nuclear facilities will be disposed of in SFR 3. There will also be room for disposal of nine reactor pressure vessels from boiling water reactors. After the extension is completed, SFR will have three times its current storage volume.

The work presented in this report is based on experience from SKB's most recent safety assessment for the existing SFR 1, SAR-08, which was published in 2008. Further, the outcome of the review of the SAR-08 assessment report performed by the Swedish safety authority has been taken into account. To the extent appropriate given the different nature of the two repositories, the methodology and process understanding developed during SKB's most recent safety assessment for a spent nuclear fuel repository in Forsmark, SR-Site, have been utilised in the present safety assessment. More recent research performed at SKB aiming at enhanced understanding of processes of relevance for repository safety in general and for long-term safety of SFR in particular, has also been utilised.

### **Regulations**

Society's requirements on the long-term safety of nuclear waste repositories are ultimately expressed in legal regulations. Two detailed regulations are issued by the Swedish Radiation Safety Authority (SSM) under the Nuclear Activities Act and the Radiation Protection Act, respectively:

- "The Swedish Radiation Safety Authority's Regulations concerning safety in final disposal of nuclear waste" (SSMFS 2008:21).
- "The Swedish Radiation Safety Authority's Regulations concerning the Protection of Human Health and the Environment in connection with the Final Management of Spent Nuclear Fuel or Nuclear Waste" (SSMFS 2008:37).

Essential portions of these documents are reproduced in Appendix A and Appendix B. The appendices also indicate how the requirements in the regulations are handled in the long-term safety assessment by reference to relevant sections or through a description directly in the appendices.

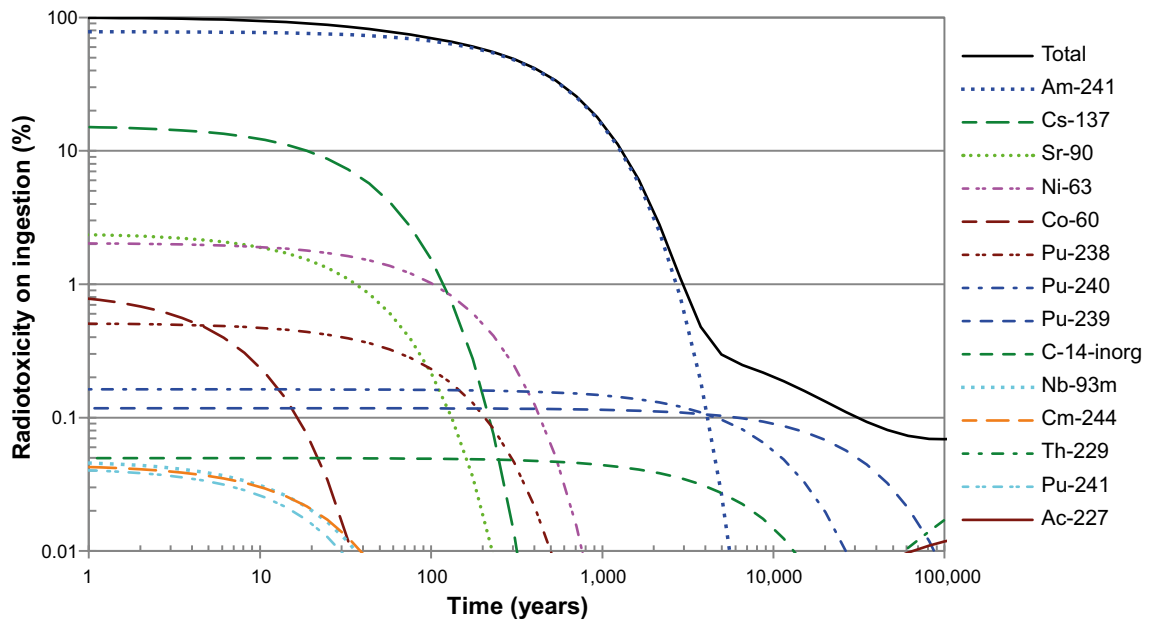
The principal acceptance criterion, expressed in SSMFS 2008:37, concerns the protection of human health and requires that "the annual risk of harmful effects after closure does not exceed  $10^{-6}$  for a representative individual in the group exposed to the greatest risk". "Harmful effects" refers to cancer and hereditary effects. The risk limit corresponds to an annual effective dose limit of about  $1.4 \cdot 10^{-5}$  Sv. This, in turn, corresponds to around one percent of the effective dose due to natural background radiation in Sweden. Besides the risk limit, SSMFS 2008:37 also requires that protection of the environment is considered. Furthermore, the regulation SSMFS 2008:21 requires descriptions of the evolution of the biosphere, geosphere and repository for selected scenarios; and evaluation of the environmental impact of the repository for selected scenarios, including the main scenario, with respect to defects in engineered barriers and other identified uncertainties.

### ***The timeframe for the assessment – one hundred thousand years***

In the general advice to SSMFS 2008:37, it is indicated that the safety assessment for a final repository for nuclear waste that is neither spent nuclear fuel nor long-lived nuclear waste should cover at least the time until the expected maximum consequences regarding risk and environmental impact have occurred, but no longer than a time span of up to one hundred thousand years after closure. A detailed risk analysis is required for the first thousand years after closure. In the present assessment, the safety of the repository is evaluated over a period of 100,000 years.

### ***The radioactivity and radiotoxicity of the waste***

The radioactivity of radionuclides in the waste to be disposed in SFR is dominated by short-lived radionuclides. This means that a large fraction of the activity deposited in SFR will decay substantially during the operational phase. The total activity content at 100 years after closure is less than half its original value, and 2% remains after 1,000 years. Initially, Ni-63 dominates the activity, but after about 1,000 years this will decay substantially, leaving Ni-59 and C-14 dominant.



**Figure S-2.** Percentage contribution to total radiotoxicity, of dominant radionuclides in SFR waste, as a function of time subsequent to closure of the repository. The percentage is related to the total radiotoxicity at closure.

Radiotoxicity on ingestion of the radionuclides is dependent on the type and energy of the radiation they emit. The radionuclides with the highest activity are not necessarily those that contribute most to the radiotoxicity of the waste. The radiotoxicity of the radionuclides in the SFR waste, displayed in Figure S-2, is dominated by Am-241. The total radiotoxicity will decrease to one percent of the radiotoxicity at closure after about 3,000 years and to one part in a thousand after 30,000 years.

### Significant improvements since SAR-08

Important improvements introduced in this safety assessment are:

- Additional site investigations (SKB 2013e) that for example involved a large number of boreholes used for fracture mapping and hydraulic tests that support the new hydrogeological model (Odén et al. 2014).
- The climate-related studies have focused on the assessment of the earliest possible onset of permafrost growth and freezing of the barrier structures in SFR. This is considered to be the most crucial aspect given the shallow repository depth, the radioactivity in the waste and the properties of the barriers in SFR.
- The radionuclide inventory has been updated (SKB 2013a, SKBdoc 1481419 (Mo-93)). The activities of organic and inorganic C-14 have been updated based on measurements performed on the ion-exchange resins at the nuclear power plants over the last years. SKB has also adjusted the method used for determining the distribution of C-14 between the waste vaults, and the activity is now proportional to the amount of ion-exchange resin deposited. The methods for determining the activity of other nuclides, for example Cl-36, Mo-93, I-129 and Cs-135, have also been improved.
- The assessment methodology has been further developed and is reasonably consistent with the methodology applied in the safety assessment of the repository for spent fuel, SR-Site (SKB 2011).
- A renewed FEP (features, events and processes) analysis has been performed resulting in a FEP catalogue with all FEPs that must be treated in the safety assessment. This is documented in a database. Today SKB's FEP database covers both the spent fuel repository and SFR.
- The initial state, i.e. the state at repository closure, has been described in more detail for example a closure plan has been prepared to provide an integrated account of how the repository is planned to be closed (SKBdoc 1358612).

- Process reports have been produced, where all internal processes identified to be of potential importance for the long-term safety of the repository system are described. Several of the internal processes are studied in more detail than previously, for example detailed water flow in the repository (Abarca et al. 2013, 2014), degradation of cellulose resulting in formation of complexing agents (Keith-Roach et al. 2014), redox evolution in the repository (Duro et al. 2012) and concrete degradation including both chemical degradation and physical/mechanical degradation due to for example the influence of reinforcement corrosion (Höglund 2014).
- Important data has been collected in a dedicated report that includes for example partitioning coefficient values for sorption,  $K_d$  values.
- A number of improvements have been made to the surface system analysis, for example a new digital elevation model and a regolith depth model have been developed. In addition the radionuclide transport model has been enhanced to better represent the transport and accumulation of C-14 in the surface systems.

## S2 Post-closure safety

The overall aim in developing a repository for nuclear waste is to ensure that the amounts of radionuclides reaching the biosphere are such that possible radiological consequences are acceptably low at all times. To this end, post-closure safety is based on preventing, limiting and delaying release of radionuclides. For SFR, this is achieved by limiting the quantity of radioactivity disposed in the repository and by ensuring retention of radionuclides in the repository.

For the SR-PSU safety assessment, a definition of the repository system is needed. The repository system is defined as the repository and its environs. The repository consists of deposited wastes, waste packaging, engineered barriers and other repository structures. The repository environs consist of the host rock surrounding the repository and the biosphere in the repository area.

### S2.1 Safety principles

In order to achieve post-closure safety for the SFR repository system two safety principles have been defined:

- *Limitation of the activity of long-lived radionuclides* is a prerequisite for the post-closure safety of the repository. This is achieved by only accepting certain kinds of waste for disposal. The design of engineered barriers is a consequence of the total activity disposed in each waste vault.
- *Retention of radionuclides* is achieved by the performance of the engineered barriers and the repository environs. The properties of the wastes, together with the properties of the waste containers and of the engineered barriers in the waste vaults, contribute to safety by providing low water flow and a suitable chemical environment to reduce the mobility of the radionuclides. The host rock provides stable chemical and physical conditions and favourable low groundwater flow conditions.

### S2.2 The repository design

A comprehensive description of the initial state of the repository and its environs, defined as the state at the time of repository closure, is one of the main bases for the safety assessment. The conditions in the environs at closure of the repository, estimated to 2075 AD, are assumed to be similar to the conditions today. The initial state of the waste and the repository is based on realistic or pessimistic assumptions concerning their conditions at closure.

The repository design includes a number of barriers. The purpose of the barriers is to contain the radionuclides, and to prevent or retard the dispersion of those substances, either directly or indirectly by protecting other barriers in the barrier system. SFR is currently located below the Baltic Sea. Until around 3000 AD when the surface above SFR has risen above sea level due to land uplift, the sea above SFR constitutes a barrier to future human intrusion.

The design of the SFR vaults (Figure S-1) has been adapted to the properties of the wastes deposited in each vault. A brief description is given here.



The silo is made of concrete and is founded on a bed of sand and bentonite. The concrete silo is surrounded by bentonite which limits the flow of water through the wastes within it. The waste in the silo is conditioned in cement, bitumen or concrete. The waste packages in the silo are continuously grouted during the operational phase. In conjunction with closure, the top part of the silo cupola will be backfilled mainly with macadam to protect against rock fallout.

1BMA and 2BMA both consist of concrete structures in which waste is deposited and surrounded by grout. In 1BMA, the waste packages are embedded in grout just prior to closure. In 2BMA the waste packages will be grouted as they are emplaced during the operational phase. The concrete structure rests on a bed of macadam/crushed rock. At closure, the waste vaults will be backfilled with macadam.

Both steel drums and concrete tanks are deposited in 1BTF. The space between the waste packages is filled with grout. In 2BTF, mainly concrete tanks are deposited. The drums are grouted during the operational phase, and the concrete tanks are grouted after operations are terminated. The space between the waste packages and the concrete wall is filled with concrete, and a lid is cast on top of this concrete and the waste packages. At the bottom is a bed of macadam and, at closure, each waste vault is backfilled with macadam.

Reactor pressure vessels (RPVs) deposited in the BRT waste vault are filled with grout before closure, after which they are embedded in concrete. At closure, the waste vault is backfilled with macadam.

The waste vaults and the access tunnels are sealed by plugs of materials with a low hydraulic conductivity. Due to the low radioactivity of the waste deposited in 1–5BLA, these flow limiting plugs are the only barriers.

In conclusion, the following are among the most important safety related features of the initial state of the repository:

- The amounts of each radionuclide in each waste vault.
- The existence and function of the engineered barriers, which act to limit the water flow through the repository and to sorb significant amounts of radionuclides delaying transport to the biosphere.
- The location of the repository below the Baltic Sea, which constitutes a barrier to future human intrusion and ensures a low hydraulic gradient during the first 1,000 years over which much of the radioactive inventory decays.

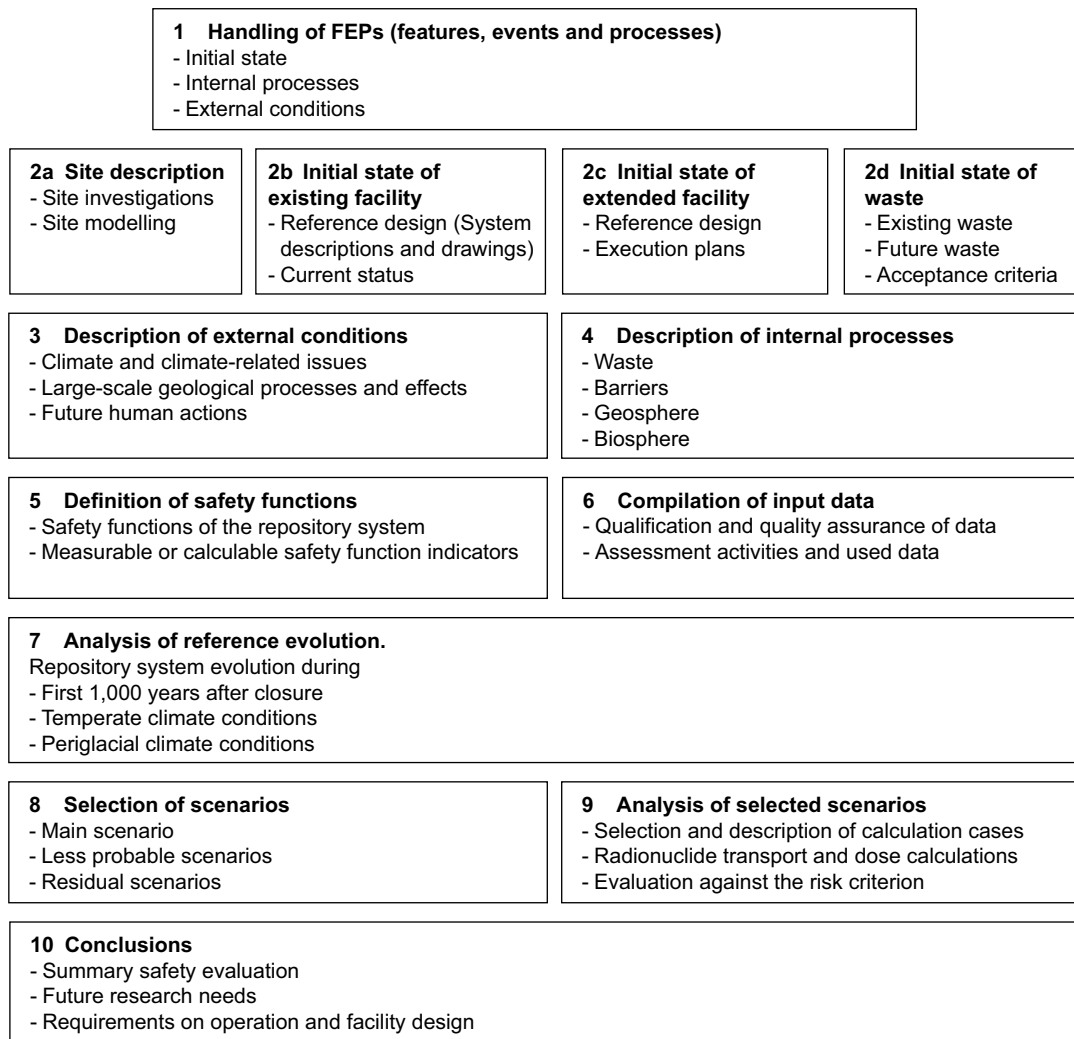
### **S3 Analysing safety – the safety assessment**

The repository system will evolve over time. Future states will depend on:

- The Initial state of the repository system. The initial state is defined as the state of the repository system at closure. In order to describe the initial state, the reference design and evolution of the repository system during the operational phase need to be considered.
- External conditions acting on the repository system after closure. External processes include climate and climate-related processes, for example permafrost and shoreline displacement and the current process of global warming. Future human actions may also affect the future state of the repository.
- Internal processes within the repository system. Internal processes include thermal, hydraulic, mechanical and chemical processes that act in the repository system. Internal processes include, for example, groundwater flow and chemical degradation affecting the engineered barriers. Another example is production of gas as a result of corrosion of metals.

Based on this information, potential patterns of evolution of the repository system are identified and characterised. By combining this characterisation with an analysis of future exposures, radiological impacts on humans and the environment are estimated.

The safety assessment SR-PSU consists of ten main steps. Figure S-3 is a graphical illustration of the steps. The methodology followed in the first nine steps of the assessment is described in the following sections, together with key results from each step. The outcome of the final step, the compilation of conclusions, is described in Section S4.



*Figure S-3. Overview of the ten steps in the methodology used for the long-term safety assessment SR-PSU.*

## Step 1: Handling of features, events and processes (FEPs)

This step in a safety assessment is to identify all factors that are important for the evolution of the repository and its environs that need to be considered in order to gain a good understanding of the evolution and safety of the repository. This is done in a screening of potentially important features, events and processes (FEPs) to identify those that are of importance for the evolution of the repository and its environs. Experience gained from previous safety assessments of SFR, including SAR-08, and international databases of relevant FEPs that affect long-term safety are utilised for this. SKB has a FEP database that was originally developed for a repository for spent nuclear fuel. This database has, through the implementation of SR-PSU, been further developed to include also the FEPs of relevance to the SFR repository. Most of the FEPs in the database are classified as initial state FEPs, internal processes or external FEPs. The remaining FEPs are either related to the assessment methodology in general or have been found to be irrelevant to SFR. Based on the results of the FEP processing, a specific SFR FEP catalogue has been compiled for the safety assessment SR-PSU. The catalogue contains the FEPs that are further handled in SR-PSU. This step of FEP processing is further described in Chapter 3 and in the **FEP report**.

## Step 2: Description of initial state

The initial state is defined as the expected state of the repository and its environs at closure. The initial state is fundamental to the safety assessment and requires thorough substantiation. The initial state of the repository part in operation (SFR 1) is based on verified and documented properties of the wastes and the repository, and an assessment of how these will change up to the time of

closure, whereas the initial state of the extension (SFR 3) is mainly based on the reference design and present waste prognosis, see the **Initial state report**. The environs of the repository at closure are assumed to be similar to those of today, as described in a site descriptive model, SDM-PSU and the **Biosphere synthesis report**. The SDM-PSU is based on the results of the site characterisation work performed during site investigations and includes data from the bedrock and the near-surface systems. A summary of the initial state of repository system is given in Chapter 4.

### Step 3: Description of external conditions

Factors related to external conditions are divided into three categories “climate and climate-related issues”, “large-scale geological processes and effects” and “future human actions (FHAs)”.

The most important part of the description of external conditions is the formulation of well-founded future evolutions of the climate and climate-related processes. These evolutions are determined based on scientific knowledge on past, present and potential future climate evolution, as well as knowledge of the processes of importance for the functioning of the repository concept to be analysed. In earlier safety assessments for low- and intermediate-level waste (SAR-08) and for spent nuclear fuel (SR-Can, SR-Site), a reconstruction of the last glacial cycle was used, along with a span of other climate cases, to assess the long-term safety of the repository. Given the shallow repository depth and the properties of the barriers in SFR, the present assessment has focused on determining the potential time of onset of the first period with permafrost in the Forsmark area. Present-day knowledge of relevance to this question has therefore been given more weight in the definition of the climate cases analysed in SR-PSU. The current state of knowledge suggests that due to human activities, in combination with small variations in future insolation, the evolution of the global climate during the coming hundred thousand years will not resemble the last glacial cycle (**Climate report**). Rather, the coming 100,000 years are expected to be characterised by a prolonged interglacial lasting 50,000, or even 100,000, years.

There are four climate evolutions, or climate cases, included in the safety assessment.

The *global warming climate case* describes a climate evolution influenced by moderate global warming combined with small variations of incoming solar radiation.

The early periglacial climate case describes limited global warming. This climate case includes the earliest potential timing of the occurrence of permafrost development in Forsmark.

The extended global warming climate case describes strong global warming and is the bounding case for a maximum duration of temperate climate conditions.

The *Weichselian glacial cycle climate case* represents a climate entirely dominated by natural climate variability as reconstructed for the last glacial cycle. This development includes ice-sheet growth within the climate case.

This step is mainly documented in the **Climate report** and supports the definition and analysis of the reference evolution as described in Step 7.

Future human actions are analysed by first identifying FEPs relevant at the site. The FEPs are then used to set up stylised FHA scenarios of which some are analysed quantitatively and others qualitatively. The FHA methodology and scenarios are described in the **FHA report** and the scenarios are also described in Chapter 7.

### Step 4: Description of internal processes

The FEP processing (Step 1) gave rise to a number of processes judged to be relevant to the evolution of the repository system. All processes identified to be of potential importance for the long-term safety of the repository system are described in the **Waste process report**, the **Barrier process report**, the **Geosphere process report**, the **Biosphere synthesis report** and in SKB (2013c).

Each process is documented in the process reports according to a template with a number of set headings. At the end of the process documentation, it is established how the process is to be handled in the safety assessment, which is a central result from the process reports. The process reports thus provide a “recipe” for handling the different processes in the assessment.

The handling of all processes in the process reports is summarised in tables that describe whether a process can be neglected, whether a qualitative assessment is made, or whether it is handled by quantitative modelling. These tables are also provided in Appendix F.

Several of the processes are handled through quantitative modelling, where each model, in general, includes several interacting processes, often occurring in different parts of the repository system and hence described in different process reports.

The models form a network, where the results from one model are used as input to another. The network of models is described graphically by an Assessment Model Flowchart (AMF; Appendix G) and an associated table with a summary of assessment activities identified in the AMF. The table includes which processes are included in each assessment activity, where the assessment activity is documented, and which couplings deliver input data to each assessment activity. Further description of the compilation of the process reports is provided in Section 3.4.

### Step 5: Definition of safety functions

A central element in the methodology is the definition of safety functions. The safety functions describe long-term functioning of the repository and its components and are an aid in the formulation of scenarios.

This step consists of identifying and describing the repository system's safety functions and how they can be evaluated with the aid of a set of safety function indicators that consist of measurable or calculable properties of the wastes, engineered barriers, geosphere, and surface system.

As described in Section S2.1, there are two overall safety principles for SFR – *limitation of the activity of long-lived radionuclides* in the waste and *retention of radionuclides*. The overall safety principles are broken down and described in terms of a number of specified safety functions and safety function indicators in Chapter 5. The safety function that has been defined for the safety principle *limitation of the activity of long-lived radionuclides* is *limited quantity of activity*. For the safety principle *retention of radionuclides*, the following safety functions have been defined: *low flow in waste vaults*, *low flow in bedrock*, *good retention*, and *avoid wells in the direct vicinity of the repository*. An example of a feature of the repository that influences the safety functions is the bentonite surrounding the silo, which contributes to the retention of radionuclides by restricting the water flow through the waste and thereby the transport of radionuclides from the repository. The corresponding selected safety function is *low flow in waste vaults* and the safety function indicator is the hydraulic conductivity of the bentonite. The fact that a safety function deviates from its expected status does not necessarily mean that the repository does not comply with regulatory requirements, but rather that more in-depth analyses of the issue and additional data are needed to evaluate safety.

### Step 6: Compilation of input data

In this step, all data to be used in the quantification of repository evolution and in radionuclide transport and dose calculations are selected using a structured process.

The selection of data is determined by the conditions that exist over the period of relevance, as well as the identified safety functions and their longevity of applicability, as reported in the dedicated **Data report** and Grolander (2013). These reports describe how essential data for the long-term safety assessment of the SFR repository are selected, justified and qualified through traceable standardised procedures.

The Assessment Model Flowchart (AMF) is used to schematically represent assessment activities (models) and data passed between the assessment activities. The data passed between the assessment activities are compiled in the **Input data report**.

## Step 7: Analysis of reference evolution

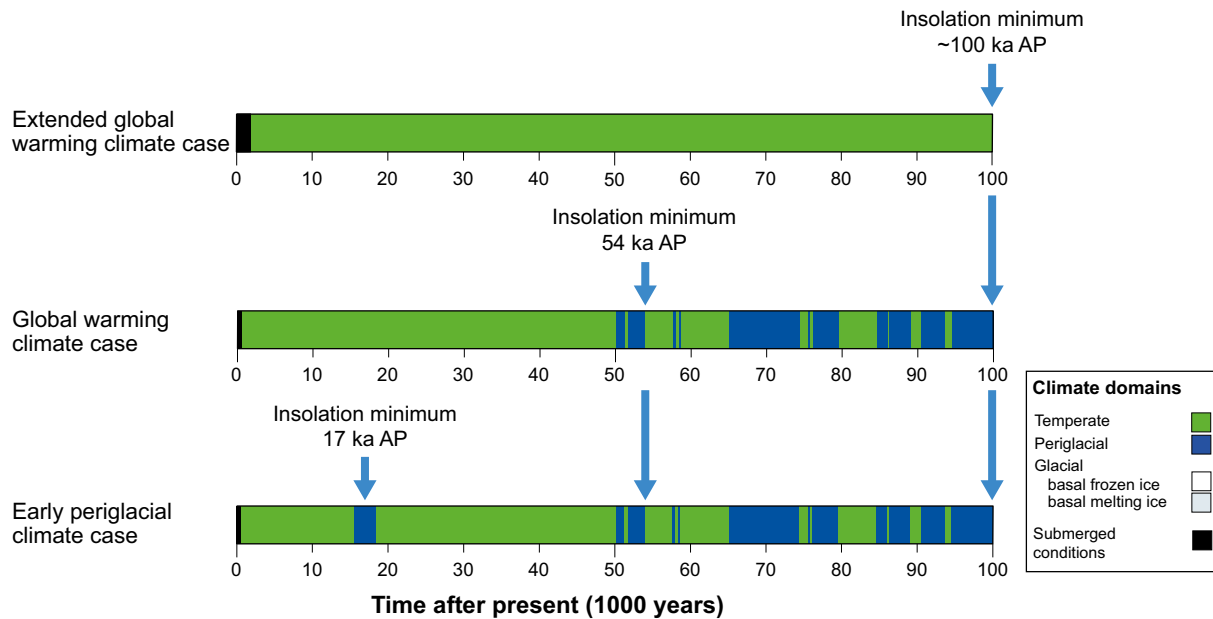
In this step, the external conditions and internal processes, identified in previous steps to be of importance for the evolution of the repository and its environs, are evaluated. To this end, a reference evolution is defined based on a range of possible future evolutions of the SFR repository system based on likely processes and events relevant for the long-term safety of the SFR repository. This step is described in Chapter 6. The initial state (Step 2) together with external conditions (Step 3) and internal processes (Step 4) that are likely to influence the evolution serve as inputs to the reference evolution.

The description of the reference evolution of the SFR repository and its environs has been divided into three parts. The first of these parts is the evolution until around 1,000 years after closure during which the climate is expected to remain temperate and the engineered barriers are expected to retain their properties. This early evolution is based on quantitative analyses and is described in detail as required by the regulation (SSMFS 2008:37). During the remaining time until around 100,000 years after closure the climate is expected to change, the shoreline will be considerably displaced and the engineered barriers will degrade. The description of the evolution for this period has been divided into one part addressing the impact on the repository of processes and events likely to occur during temperate climate conditions and a second part addressing the impact on the repository of processes and events likely to occur during periglacial climate conditions. As described in Step 3, it is very likely that the present Holocene interglacial will be considerably longer than previous interglacials and that the onset of the next glaciation will not occur in the next 50,000, or perhaps not even in the next 100,000 years. The glacial climate domain is therefore not included in the reference evolution. For each timeframe and climate condition, the evolution of the SFR repository system is presented for:

- Evolution of surface systems.
- Thermal evolution.
- Mechanical evolution.
- Hydrogeological evolution.
- Near-field hydrological evolution.
- Geochemical evolution.
- Chemical evolution in the repository.
- Evolution of engineered barriers.

All of these processes are of importance for the future evolution of the repository system and an extensive and detailed description is given in Chapter 6. A brief description of the evolution of the external conditions is given in the following paragraph.

Three climate cases representing prolonged interglacial conditions at Forsmark (Step 3), are included in the reference evolution; the *early periglacial*, the *global warming*, and the *extended global warming* climate cases. The evolution of climate-related issues in the three climate cases includes periods of temperate and periglacial climate conditions as displayed in Figure S-4. The main climate-related issues of importance to the reference evolution are shoreline displacement, resulting from land uplift due to a combination of isostasy and eustasy, and permafrost development. Several processes and events are highly affected by the shoreline regression. In the *global warming* and *early periglacial* climate cases the surface above the repository will gradually rise above sea level during the first 1,000 years after closure and at the end of the period the entire area above the repository will be situated above the shoreline. In the *extended global warming climate case*, it takes about 1,200 years longer before the entire area above the repository will be situated above the shoreline. The first period of periglacial conditions in Forsmark occurs around 17,500 AD in the *early periglacial climate case*. During this period, the bedrock temperature can fall below 0°C at repository depth, however bedrock temperatures of –3°C or less, which would require analysis of freezing of concrete repository structures, are not likely. At the time of the first occurrence of periglacial climate conditions in the *global warming climate case*, around 52,000 AD, bedrock temperatures of –3°C or less cannot be excluded.



**Figure S-4.** Evolution of climate-related conditions at Forsmark as a succession of climate domains and submerged periods for the climate cases included in the reference evolution.

## Step 8: Selection of scenarios

### Method for scenario selection

A key feature in managing uncertainties in the future evolution of the repository system is the reduction of the number of possible evolutions to be analysed by selecting a set of representative scenarios. The selection focuses on addressing the safety-relevant aspects of the evolution expressed at a high level by the safety functions which are further characterised by reference to safety function indicators.

There are also several issues concerning applicable regulations that have to be taken into account in the selection of scenarios. Given the regulatory requirements and the general considerations above, scenarios have been selected as explained below.

### 1. Definition of the main scenario

A main scenario is defined, based on the reference evolution and in accordance with SSMFS 2008:21. The main scenario is based on the initial state (Step 2) and the processes that are found to be of importance for the long-term evolution and safety of the repository (Step 7). The reference evolution, as presented in Chapter 6, is defined based on a range of possible future evolutions of the SFR repository system, whereas the main scenario is more specific in order to permit the evaluation of the radiological risk. The main scenario is split into two variants, based on the global warming and the *early periglacial* climate cases in the reference evolution.

### 2. Selection of less probable scenarios

Less probable scenarios of relevance for assessing the long-term safety of the repository are defined by considering the safety functions presented in Step 5. Scenarios are selected by going through possible routes to violation of each safety function, i.e. by examining the uncertainties in initial state, internal processes and external conditions and assessing if there is a possibility that the status of the safety function deviates from that in the main scenario in such a way that a lower degree of safety is indicated. Thereby an alternative evolution of the repository system deemed to be of importance for the long-term function of the repository is identified. The probability of each scenario is assessed based on the scenario-generating uncertainty in initial state, internal processes and/or external conditions.

Table S-1 summarises the less probable scenarios and the safety functions that deviate from those of the main scenario.

**Table S-1. Safety functions and selected less probable scenarios.**

Safety function					Scenario
Limited quantity of activity	Low flow in bedrock	Low flow in waste vaults	Good retention	Avoid wells in the direct vicinity of the repository	
x					High inventory scenario
	x				High flow in the bedrock scenario
		x			Accelerated concrete degradation scenario
		x			Bentonite degradation scenario
	x	x			Earthquake scenario
			x		High concentrations of complexing agents scenario
				x	Wells downstream of the repository scenario
				x	Intrusion wells scenario

### 3. Selection of residual scenarios

A set of residual scenarios is also defined. These consist of scenarios chosen in order to illustrate:

- The significance of individual barriers and barrier functions.
- Exposure due to human intrusion and consequences of an unclosed repository.
- Consequences of external conditions within the range defined by the SR-PSU climate cases that are not included in the main scenario.

The residual scenarios are analysed regardless of their probability.

### 4. Scenario combinations

For the scenario selection to be comprehensive, combinations of the scenarios and variants must be considered. This is done when all the scenarios have been selected. The number of possible combinations could become large, even considering that mutually exclusive scenarios should not be combined, and a practical approach for handling this situation has to be adopted.

## Step 9: Analysis of selected scenarios

### *Selection and description of calculation cases*

To judge radiological consequences, the scenarios have to be evaluated with the aid of calculation cases that are analysed with mathematical models. The way in which the calculation cases are defined and set-up is described in Chapter 8.

The calculation cases have been divided into groups, corresponding to the three scenario categories: main scenario, less probable scenarios and residual scenarios, and scenario combinations.

### *Radionuclide transport and dose calculations*

This step comprises the quantitative calculation of radionuclide transport from the waste through the repository (near-field) and the rock (geosphere/far-field) to the surface system (biosphere), and evaluation of the doses to humans and dose rates to biota that can arise from exposure to repository-derived radionuclides, see Chapter 9 and the **Radionuclide transport report**.

### *Evaluation against the risk criterion*

The radiological risk is estimated for the main scenario and for the less probable scenarios. This step is described in Chapter 10. The risk for a scenario is calculated by multiplying the probability of the scenario by the calculated dose consequence. The estimated risk is compared with SSM's risk criterion. The main scenario and the less probable scenarios are included in the summation of the total risk for the repository.

## Results

The highest maximum annual radiological risk ( $6.0 \cdot 10^{-7}$ ) is obtained for the main scenario. The second highest annual radiological risk ( $2.6 \cdot 10^{-7}$ ) is obtained for the *intrusion wells scenario* for 1BLA. The maximum radiological risk for each of the other scenarios is generally one or more orders of magnitude lower than that for the main scenario.

For most scenarios, the radiological risk increases initially with time and then decrease or remain nearly constant during the rest of the assessment period. However, the radiological risk for the *earthquake scenario* show a different time variation. For the *earthquake scenario*, an increasing trend with time is observed, which is explained by the increasing cumulative probability that an earthquake event will occur before a given time point; whereas the maximum dose values remain nearly constant during the whole period after an earthquake has occurred.

The calculated risks for the main scenario and for the less probable scenarios are summed, taking the probability of each less probable scenario into account, to obtain a total risk over time for the repository. The maximum total risk  $9.0 \cdot 10^{-7}$  is obtained at 5000 AD.

## S4 Conclusions of the SR-PSU assessment

As mentioned initially, the central conclusion of the safety assessment SR-PSU is that the planned extension of the SFR meets regulatory criteria with respect to long-term safety.

The conclusions from the SR-PSU assessment are given in Chapter 11. Three major roles for the presentation of the conclusions from the SR-PSU assessment can be distinguished:

1. To demonstrate compliance with applicable Swedish regulations for the disposal of radioactive wastes in the SFR repository in Forsmark.
2. To identify requirements and constraints that needs to be satisfied for the conclusions of the safety assessment to be valid.
3. To provide feedback to design development, to SKB's RD&D Programme, to detailed site investigations and to future safety assessments.

These aspects are briefly described here.

### S4.1 Demonstration of compliance

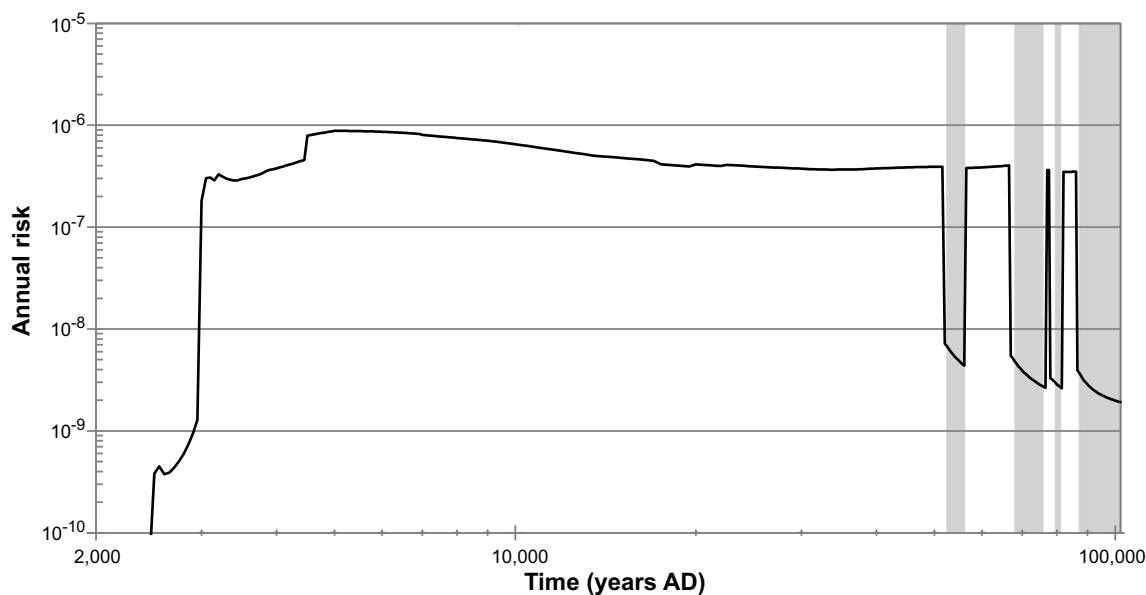
The results of the radiological risk estimations show that the maximum annual risks from all individual scenarios, i.e. for each variant of the main scenario and for each less probable scenario, are below the principal regulatory acceptance criterion of  $10^{-6}$  for the annual radiological risk to a representative individual from the most exposed group.

Furthermore, the total risk for the combination of the main scenario with all less probable scenarios is below the regulatory risk criterion of  $10^{-6}$  during the whole assessment period of 100,000 years. The total risk for the combination of the main scenario with all less probable scenarios is shown in Figure S-5.

Exposure of non-human biota has been estimated by comparing calculated dose rates to organisms from marine, freshwater and terrestrial ecosystems with the screening values adopted for this assessment. All calculated dose rates were lower than the screening values, indicating that the repository will not affect biodiversity or sustainable use of biological resources.

In the light of the overall results obtained, SKB concludes that the assessment presented here shows that SFR 1 and SFR 3 fulfil the criteria on protection of human health and the environment for final disposal of radioactive waste that have been established by the Swedish radiation safety authority, SSM, for all waste types.





**Figure S-5.** Total radiological risk obtained from the combination of the maximum of the main scenario variants and all less probable scenarios. The unshaded areas correspond to temperate climatic conditions and the grey shaded areas to periglacial conditions with continuous permafrost.

## S4.2 Requirements and constraints

As a result of the safety assessment, a number of requirements and constraints on the wastes, and on design, construction and operation of the repository have been identified. The basis for the present safety assessment is the description of the initial state. The description contains some uncertainties in design, construction and operation of the repository, as well as in the composition of the wastes. The conclusions of the analysis are valid for the initial state under the assumed conditions. Some of the assumptions may therefore result in additional requirements on the repository and its components in order to satisfy these assumptions.

### Design

The most important requirements and constraints for the design are the following.

- The purpose of the engineered barriers in SFR is to prevent, limit and delay releases of radionuclides to the surrounding environs. In order for the engineered barriers to meet stipulated requirements on long-term function, care must be taken in the selection of materials and methods for the design and construction of the engineered structures.
- One specific requirement is the need to maintain high pH in the waste form in order to minimise microbial activity, especially methanogenes, in the repository.

### Construction and operation

Requirements on construction, for instance the use of rock support, the choice between different materials, and situations where special precautions need to be taken or special procedures need to be used during blasting, need to be further specified.

The assumptions made in the present assessment on future disposal strategy are necessary for the assessment, but the degree to which uncertainties in the disposal strategy affect the results has not been investigated.

## **Waste**

Waste to be deposited in SFR must meet special waste acceptance criteria (WAC) that regulate the properties of the waste. Preliminary WAC for the extended SFR have been formulated as a basis for the application for the extension of SFR, based on existing WAC for the existing SFR. These preliminary WAC have, together with the properties of existing wastes, served as a point of departure for technology development, but WAC have been and will also in the future be affected by the results of the long-term safety assessment and ongoing technology development, where technical designs for barrier structures and repository closure will be stipulated in increasing detail during the coming years. It is therefore to be expected that WAC will change over time as knowledge is gained regarding the waste and the final repository system. Areas where continued work and possible changes in preliminary WAC can be expected are chemical reactivity (e.g. in relation to complexing agents), gas evolution and inner mechanical stability (swelling and voids).

### **S4.3 Need for further RD&D**

The safety assessment has revealed areas that need to be explored for future long-term safety assessments. Some of these areas are specific to the SFR repository, whereas others can be relevant for both SFR and the planned repository for long-lived waste (SFL). Some areas, especially questions related to the bedrock and the biosphere, are of importance also to the repository for spent nuclear fuel. The previously planned future work related to the long-term safety of SFR is described in the RD&D programme (SKB 2013d). A number of areas for which additional research efforts might contribute to reduce uncertainties in future safety assessments have been identified in SR-PSU. These activities are compiled in Section 11.5.3 and will be considered in the coming RD&D programme 2016.

# 1 Introduction

## 1.1 Background

The Swedish system for management of low- and intermediate level-waste from nuclear power plants and other nuclear activities such as industry, research (laboratories) and medical care includes facilities for treatment, transportation, interim storage and final disposal. These facilities are operated by the waste producers or Swedish Nuclear Fuel and Waste Management Co., SKB. A repository for low- and intermediate radioactive operational waste (SFR) at Forsmark in the municipality of Östhammar is operated by SKB. SKB, which also operates a transportation system, including a dedicated ship for transportation of the waste. The nuclear power companies, AB SVAFO and Studsvik Nuclear AB operate local treatment plants, interim storage facilities and surface repositories for short-lived very low level operational waste.

In the future, the nuclear power plants in Sweden will be decommissioned and dismantled and the majority of the waste is planned to be disposed in SFR. A need for additional disposal capacity in SFR has been accentuated by the closure of the two reactors in Barsebäck. Additional disposal capacity is needed also for operational waste from nuclear power units in operation since their operating life-times have been extended compared with what was originally planned. SKB therefore plans to extend the facility with a new part directly adjoining the existing SFR. In addition, the extended part of SFR will be used for interim storage of long-lived low- and intermediate-level waste awaiting final disposal in a future repository for long-lived waste (SFL), which is planned to be in operation around 2045.

The extension of the SFR facility requires two licence applications: One under the Nuclear Activities Act (SFS 1984:3) and one under the Environmental Code (SFS 1998:808). The licensing documentation consists of application documents and a set of appendices. Important appendices are the Environmental Impact Assessment and the first preliminary Safety Analysis Report (F-PSAR) for the extended SFR. The first preliminary Safety Analysis Report contains two sub-reports, these are the operational safety report and the present report.

The purpose of the present report in the licence applications is to demonstrate the long-term (post-closure) safety of the extended SFR repository. This is done by conducting a detailed safety analysis and evaluate the compliance with the regulatory criteria (SSMFS 2008:21 and 2008:37) concerning safety and protection of human health and the environment in the long-term perspective. The long-term safety of the present SFR has been assessed on several occasions. The most recent safety assessment, SAR-08, was reported to the regulator in 2008 (SKB 2008a). The preliminary safety report that served as a basis for the Government licence to build the facility was produced in 1982, and the supplemented safety report that was required for the operating licence for the rock vaults was finished in 1987. The safety report was then supplemented to include the silo repository in 1991 and updated in 1993. The safety assessment SAFE was reported to the regulatory authorities in 2001, and supplements to this were produced in response to the regulator in 2005 and in SAR-08.

In addition to demonstrating long-term safety, the purpose of the present report is also to identify areas where further research and technology development are needed. The report complements SKB's RD&D programme and will help in prioritising further research work.

### 1.1.1 SKB's system for waste disposal

SKB plans to operate three repositories:

- The final repository for short-lived radioactive waste (SFR). This repository is designed for disposal of short-lived low- and intermediate-level waste. The properties of these wastes differ, which means that the wastes must be packaged and handled in different ways. The design of the repository has therefore been adapted so that different types of waste can be disposed of in a manner that is suitable for each type.

- The final repository for long-lived radioactive waste (SFL). This repository will be designed for waste that must be isolated from the environment for a longer time than the waste in SFR. Similarly to SFR, the properties of this waste differ, which means that the waste must be packaged and handled in different ways. SKB will perform a first safety evaluation for SFL over the next few years.
- The final repository for spent nuclear fuel. This repository is designed for disposal of spent nuclear fuel and SKB submitted an application for a licence to build this repository in 2011.

There is also a system for transportation of the different waste types from the nuclear power plants to the waste facilities. Figure 1-1 shows the three repositories and the major waste streams.

SKB is presently investigating whether a near-surface repository can provide an alternative to SFR for disposal of portions of the waste from dismantling and demolition of nuclear facilities in an environmentally and radiologically safe and cost-effective manner. The future allocation and clearance of the waste streams to SFL, SFR, a possible future near-surface repository need to be guided by clear principles to support the producers of radioactive waste on how it shall be handled. SKB are developing such principles.

## 1.2 SFR

SFR is a hard rock repository for short-lived low- and intermediate-level radioactive waste that has been in operation since 1988. The repository is located below the Baltic sea and is covered by about 60 metres of rock. It is reached via two one-kilometre-long access tunnels from the ground surface. The repository includes underground waste vaults along with surface technical facilities.

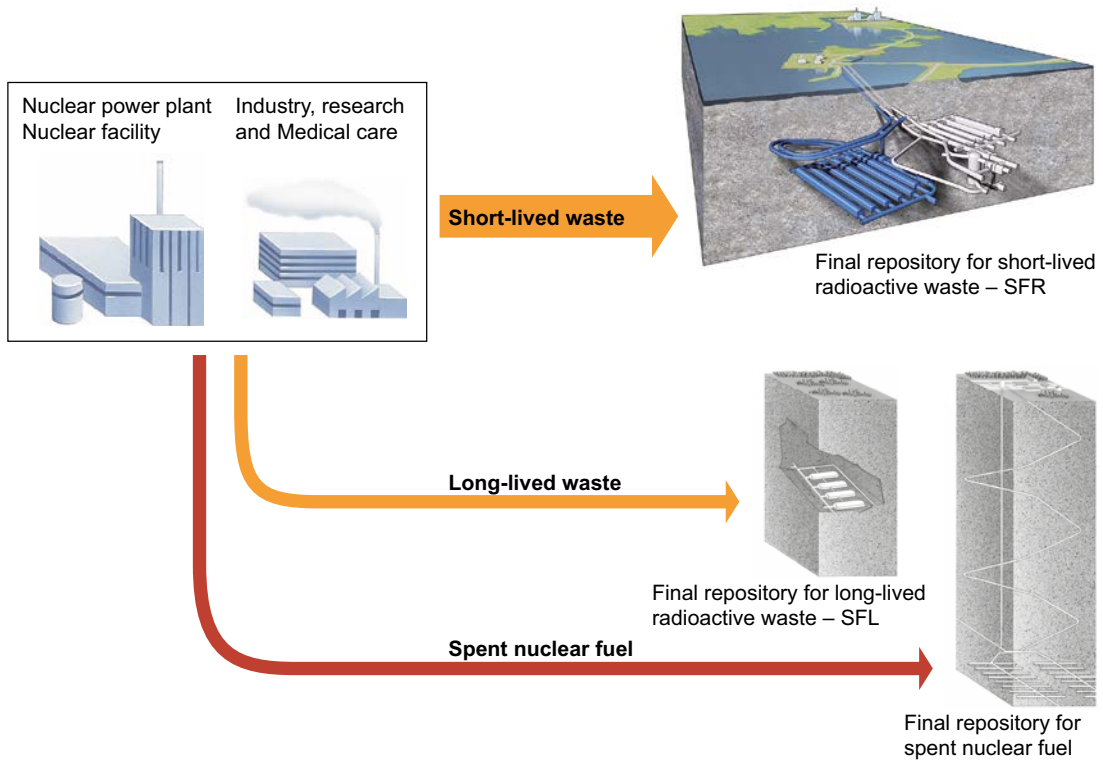
The underground part of the existing facility, named SFR 1, consists of four 160-metre-long waste vaults, plus a 70-metre-high vault with a concrete silo, see Figure 1-2. The present total storage capacity is 63,000 m<sup>3</sup>. Low-level waste is kept in the 1BLA waste vault. Intermediate-level waste with relatively low activity levels is kept in two vaults, 1BTF and 2BTF. The intermediate-level waste with higher activity levels is disposed in the waste vaults 1BMA or silo, the latter contains most of the activity content in SFR. Today, operational waste from the nuclear power plants and from the other nuclear facilities is disposed of in SFR 1.

The extension of SFR will be built at about 120 metres depth, i.e. at the same level as the bottom of the silo, see Figure 1-2. To make room for additional operational waste and the waste from decommissioning of all existing Swedish nuclear power reactors and other nuclear facilities the extension will have a storage capacity of 108,000 m<sup>3</sup> plus nine boiling water reactor pressure vessels. After the extension is completed, SFR will have three times its current capacity. Altogether, there will be six new waste vaults, varying in length from 210 to 275 m; four waste vaults for low-level waste (2-5BLA), one waste vault for BWR-reactor pressure vessels (BRT) and one waste vault for intermediate-level waste (2BMA).

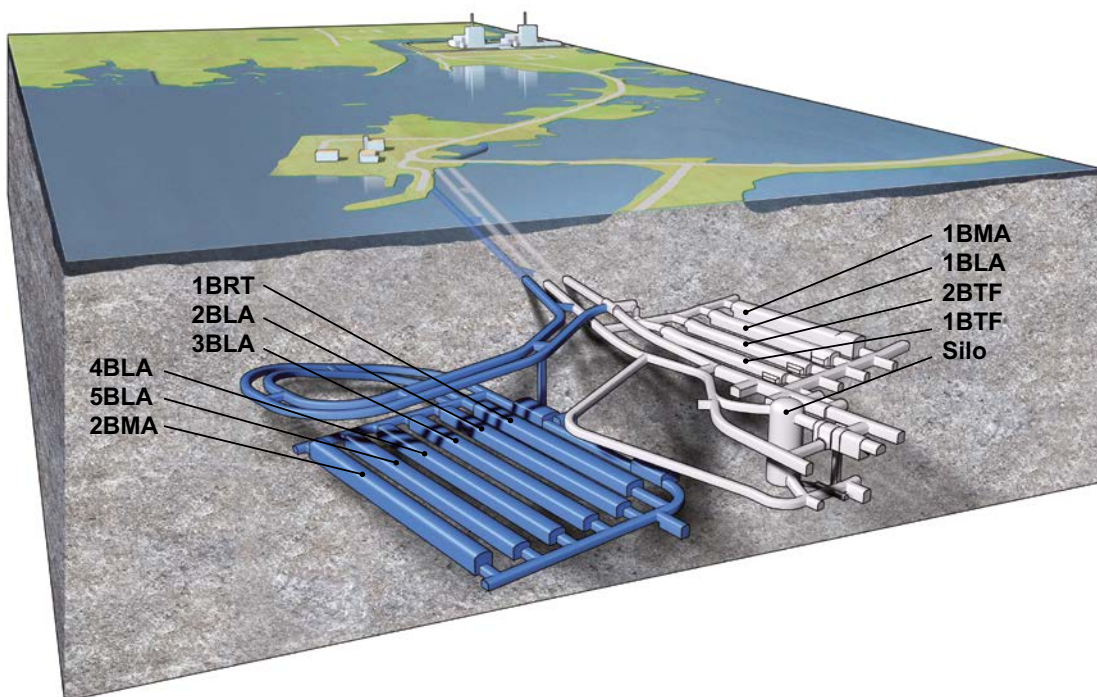
The physical and radiological properties of the various types of waste to be disposed at SFR differ, and the waste is packaged and handled accordingly. As a consequence, the design of the SFR vaults has been adapted to the properties of the waste. One of the most important properties is the activity content, but also other factors, such as the potential for gas production, have also been taken into account.

The silo is made of concrete and is founded on a bed of sand and bentonite. The concrete silo is also surrounded by bentonite which limits the flow of water through the wastes within it. The waste in the silo is conditioned in cement, bitumen or concrete. The waste packages in the silo are continuously grouted during the operational phase. In conjunction with closure, the top part of the silo cupola will be backfilled with macadam to protect against rock fallout.

1BMA and 2BMA each consist of a concrete structure in which waste is deposited and which is surrounded by backfill. In 1BMA the waste packages are embedded in grout just prior to closure. In 2BMA the waste packages are grouted as they are emplaced during the operational phase. The concrete structure rests on a bed of macadam/crushed rock. At closure, the waste vaults will be backfilled with macadam.



*Figure 1-1. SKB's existing and planned final repositories.*



*Figure 1-2. Extended SFR with access tunnel and names of the waste vaults. The existing part is shown in light grey and the planned part is shown in blue. The waste vaults in the figure are the silo for intermediate-level waste, 1BMA and 2BMA vaults for intermediate-level waste, 1–2BTF vaults for concrete tanks with intermediate-level waste with low activity levels, 1BLA and 2–5BLA vaults for low-level waste and the BRT vault for reactor pressure vessels.*

Both steel drums and concrete tanks are deposited in 1BTF. In 2BTF, only concrete tanks are deposited. The drums are grouted as they are emplaced during the operational phase, and the concrete tanks are grouted after operations are terminated. The space between the waste packages and the concrete wall is filled with concrete, and a lid is cast on top of this concrete and the waste packages. At the bottom is a bed of macadam and at closure, each waste vault is backfilled with macadam.

Reactor pressure vessels (RPVs) are filled with grout and deposited in the BRT waste vault, after which they are embedded in concrete. At closure, the waste vault is backfilled with macadam.

Due to the low radioactivity of the waste to be deposited in 1–5BLA, the only barriers are plugs.

The interim storage for long-lived low- and intermediate-level waste awaiting final disposal in SFL will be placed in appropriate waste vaults.

## **1.3 Waste to be disposed in SFR**

### **1.3.1 Classification of nuclear waste**

The radioactive wastes from operation and decommissioning of nuclear reactors and other nuclear facilities are of various types. To confirm practical strategies for the safe management of radioactive waste, a classification of the waste is helpful. Such classification is generally based on the activity content and the half-lives of the radionuclides in the waste. The activity content in the waste, high-level, intermediate-level or low-level, is significant in defining the requirements for radiation shielding and cooling in connection with management.

Internationally, various classifications of radioactive waste are applied, e.g. IAEA's classification of radioactive waste, GSG-1 (IAEA 2009), which comprises six classes (Figure 1-3). The IAEA Member States have, however, not agreed on a common classification of radioactive waste meaning that this is up to each Member State.

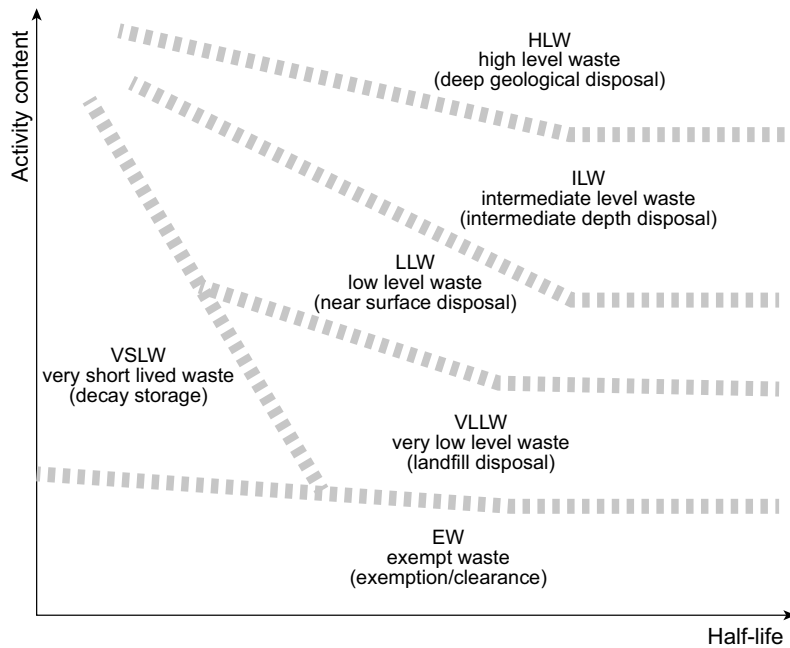
There is no official classification applied in Sweden, and SKB uses the following definitions:

- High level waste has high activity content and requires both shielding and cooling during handling and storage.
- Intermediate-level waste requires shielding, but no cooling, during handling and storage.
- Low-level waste can be handled without special shielding.

The intermediate- and low-level waste can be divided into short-lived and long-lived. The activity content in long-lived waste is dominated by long-lived radionuclides, i.e. radionuclides with half-lives longer than 31<sup>1</sup> years, whereas the short-lived waste must include only “limited amounts” of these radionuclides. There is no clear definition given in any Swedish regulations or guidelines of what is meant by “limited amounts”. There is neither any description of which waste is to be regarded as short- or long-lived in the regulations from SSM. This means that it is up to the licensee to show that the waste disposed or to be disposed in a repository is such that the expected consequences regarding risk and environmental impact conform to set criteria and occur within the assessment period.

---

<sup>1</sup> Short-lived waste is defined according to the IAEA Safety Glossary, 2007 Edition (IAEA 2007) as “radioactive waste that does not contain significant levels of radionuclides with half-lives greater than 30 years”. SKB uses the same definition but with 31 years to include cesium-137, which is used as a key radionuclide to estimate the content of other radionuclides. Waste that is not short-lived is consequently considered long-lived.



**Figure 1-3.** Conceptual illustration of the waste classification scheme according to GSG-1 (IAEA 2009).

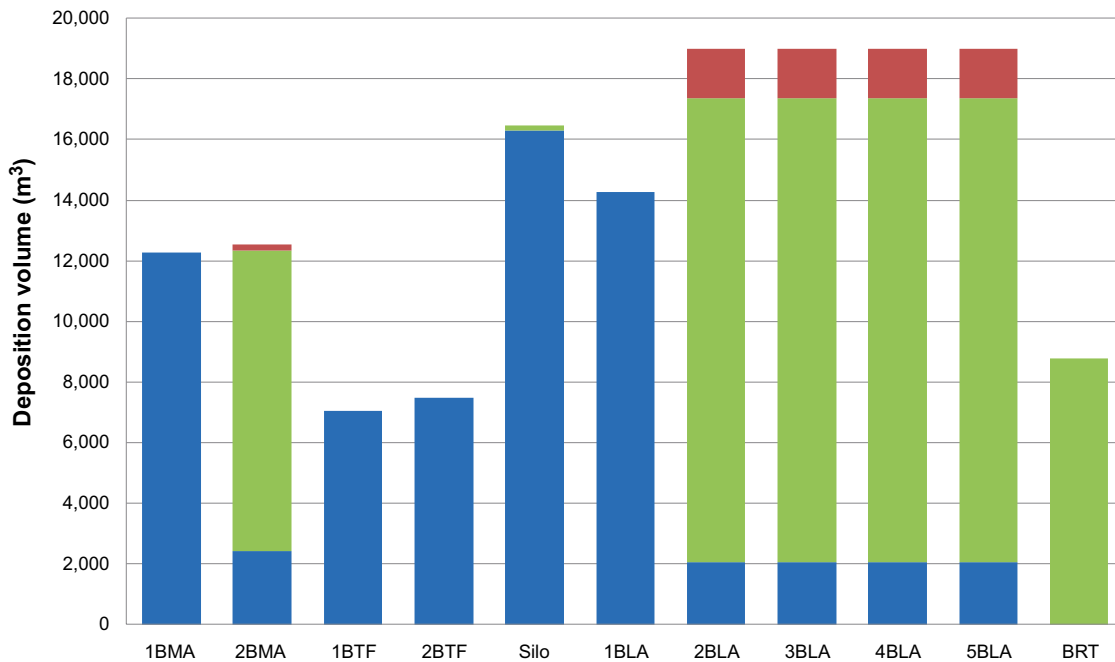
### 1.3.2 General description

The largest volumes of radioactive waste occurring during the operation of the nuclear power plants consist of low- and intermediate-level waste. This waste consists mainly of spent ion-exchange resins from cleaning reactor water, scrap metal from refurbishment, and contaminated consumable items such as protective clothing and equipment. The contamination derives from leakage of radio-nuclides from the fuel or from neutron activation of particles in the reactor water and structural components of the reactors. Low- and intermediate-level waste from other Swedish nuclear facilities, including the shutdown nuclear reactor Ägesta, the shutdown nuclear research reactors in Studsvik as well as from the interim storage facility for spent fuel (Clab) will also be disposed in SFR. In addition, there is legacy waste from AB SVAFO (a company that treats radioactive waste and facilities from early Swedish nuclear research) and Studsvik Nuclear AB (a company that treats radioactive waste that includes waste from hospitals, research and industry).

The waste packaging used in SFR are ISO containers, concrete tanks, steel drums, and concrete or steel moulds. BMA and silo wastes are either solidified with cement or bitumen (e.g. ion-exchange resins, concentrates and sludge) or embedded with concrete (solid waste e.g. trash and scrap metal). This can be preceded by e.g. incineration, compaction, segmentation or even melting of the wastes. All waste disposed of in SFR must conform to approved waste acceptance criteria.

The majority of the waste to be disposed in the SFR extension will originate from the dismantling of the nuclear power plants and other nuclear facilities. This waste is mainly activated or contaminated reactor components, scrap metal, concrete and other building materials. The reactor pressure vessels from the boiling water reactors will be disposed whole in SFR without prior segmentation, but after removal of all internal parts.

The current prognosis (SKB 2013a) shows that the volume of decommissioning wastes is expected to be larger than that of operational wastes (Figure 1-4), but their activity content will generally be lower.



**Figure 1-4.** Current prognosis of the volume of waste allocated to each vault. Operational waste (about 60,000 m<sup>3</sup>) is shown in blue, decommissioning waste (about 100,000 m<sup>3</sup>) in green and secondary decommissioning waste (7,000 m<sup>3</sup>, mostly materials that have been brought into a classified area, used, contaminated and discarded) in red. Modified figure from the *Initial state report*<sup>2</sup>.

### 1.3.3 Activity and radiotoxicity of the waste

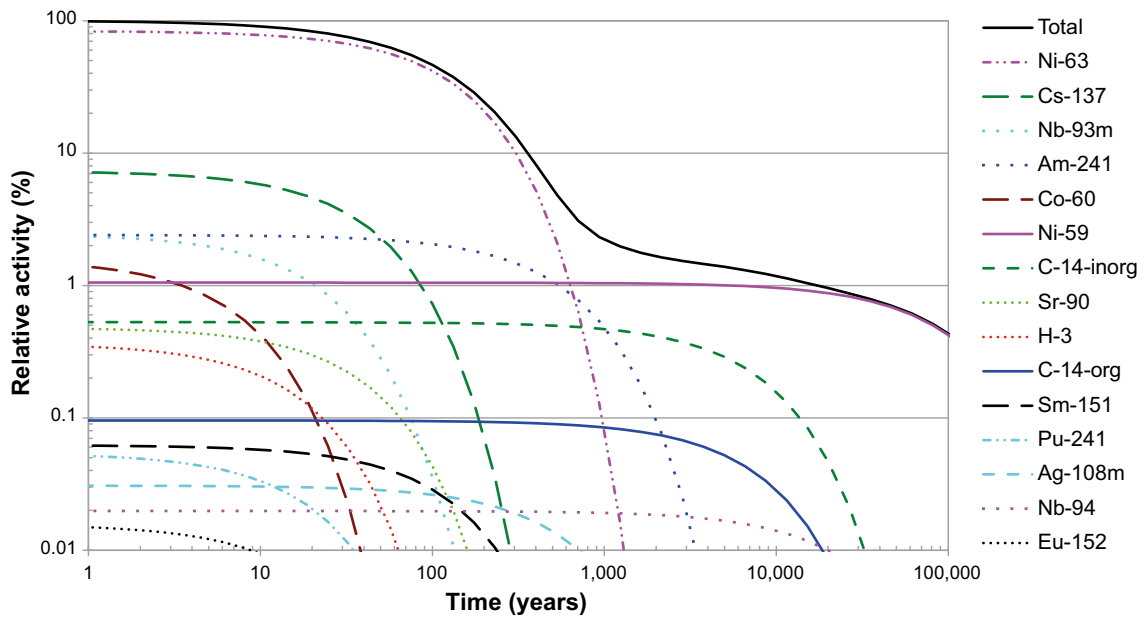
The activity of radionuclides in the waste to be disposed in SFR is dominated by short-lived radionuclides. This means that a large portion of the activity deposited in SFR will decay substantially during the operational phase, e.g. Fe-55 and Co-60 which to a large extent determine the surface dose rates on the waste packages. The decline in the activity of the waste from the time of repository closure up to around 100,000 years after closure is depicted in Figure 1-5. As can be seen in the figure, the total activity content at 100 years after closure is less than half its original value, and 2% remains after 1,000 years. Initially, Ni-63 dominates the activity, but after about 1,000 years Ni-59 and C-14 will become dominant. The inorganic and organic forms of C-14 are presented separately in Figure 1-5, since they have different transport properties.

Taking into account the necessity to fulfil regulatory requirements, arguments relating to the radiotoxicity of the nuclear waste can be considered as a basis for the safety assessment timescale.

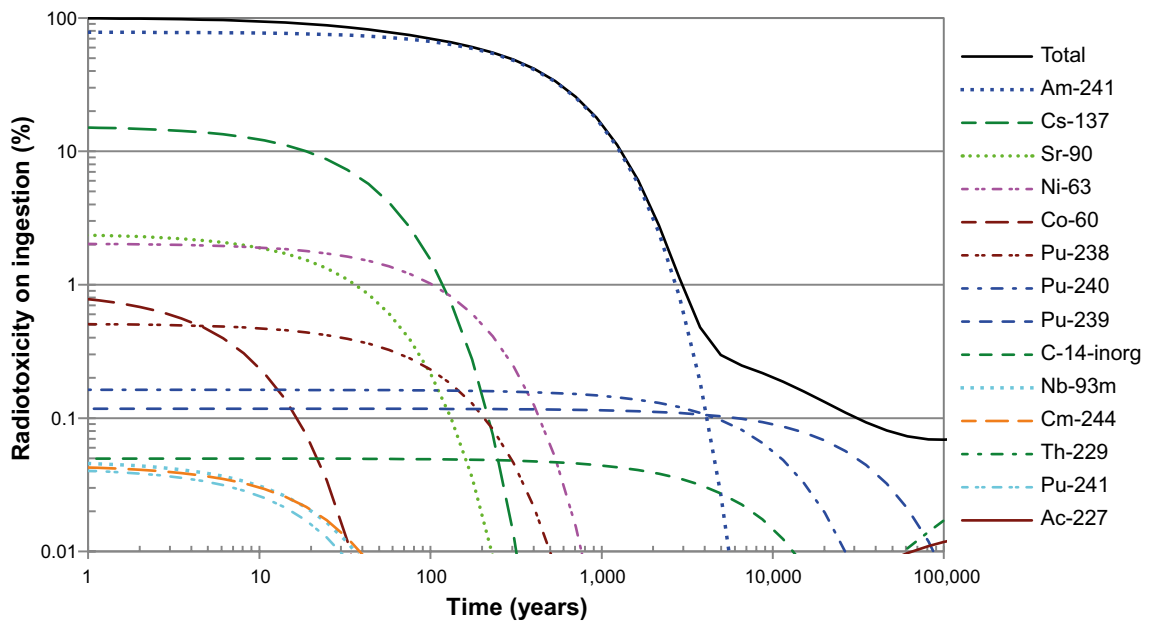
The radiotoxicities of the radionuclides are dependent on the type and energy of the radiation they emit. The radionuclides with the highest activity are not necessarily those that contribute most to the radiotoxicity of the waste. For example, the radiation from I-129 has much higher energy than that from Ni-59 and thereby a higher radiotoxicity. One way to describe this is by calculating the committed effective dose from ingestion of radionuclides. The radiotoxicity of the radionuclides in the SFR waste as a function of time after closure has been calculated. Figure 1-6 shows the relative radiotoxicity over time and the radionuclides that contribute most to the radiotoxicity of the waste. The radiotoxicity is dominated by Am-241 disposed in the silo. It can be seen in the figure that the total radiotoxicity will decrease to one percent of the radiotoxicity at closure after about 3,000 years and to one part in a thousand after 30,000 years.

<sup>2</sup> Abbreviation used to refer to Main references, see Section 2.5.





**Figure 1-5.** Percentage contributions to the total activity by dominant radionuclides as a function of time subsequent to closure of the repository. The percentage is related to the total activity at closure.



**Figure 1-6.** Percentage contribution to total radiotoxicity, of radionuclides in SFR waste, as a function of time subsequent to closure of the repository. The percentage is related to the total radiotoxicity at closure.

## 1.4 Regulations in relation to safety assessment

The format and scope of a long-term safety assessment, specifically the criteria to be used to assess the safety of the repository, are defined in regulations from the Swedish Radiation Safety Authority (SSM). The regulations are based on various pertinent components of framework legislation, the most important being the Nuclear Activities Act and the Radiation Protection Act. Guidance on radiation protection matters is provided by a number of international bodies, and national legislation is often, as is the case of Sweden, influenced by international recommendations.

Regarding the long-term safety of nuclear waste repositories, there are two more detailed regulations of particular importance, issued under the Nuclear Activities Act (SFS 1984:3) and the Radiation Protection Act (SFS 1988:220) respectively:

- “The Swedish Radiation Safety Authority’s Regulations concerning safety in connection with the disposal of nuclear material and nuclear waste” (SSMFS 2008:21). The same document contains general advice on the application of the regulations.
- “The Swedish Radiation Safety Authority’s Regulations concerning the protection of Human Health and the Environment in connection with the Final Management of Spent Nuclear Fuel and Nuclear Waste” (SSMFS 2008:37). The same document contains general advice on the application of the regulations.

Potential risks to human health and the environment due to chemically toxic materials in the repository are addressed in the Environmental Impact Assessment (SKB 2014a).

## 1.5 This safety assessment

The current document is, together with supporting documents, a part of SKB’s application to extend the SFR repository in order to enable disposal of decommissioning waste. Additional disposal capacity is needed also for operational waste from nuclear power units in operation since their operating lifetimes have been extended compared with what was originally planned.

The main purposes of the safety assessment project SR-PSU are:

- To demonstrate compliance with applicable Swedish regulations for the disposal of radioactive wastes in the SFR repository in Forsmark.
- To identify requirements and constraints that needs to be satisfied for the conclusions of the safety assessment to be valid.
- To provide feedback to design development, to SKB’s RD&D Programme, to detailed site investigations and to future safety assessment projects.

Assessments of the post-closure safety for SFR have been reported at several occasions, the latest assessment was the SAR-08 safety assessment reported in 2008. Following the review of SAR-08, the regulator published a review report, this report is reproduced in Appendix D together with a short description of how the different review comments were addressed in the current assessment.

### ***Significant improvements since SAR-08***

Important improvements introduced in this safety assessment are:

- Additional site investigations (SKB 2013e) that for example involved a large number of boreholes used for fracture mapping and hydraulic tests that support the new hydrogeological model (Odén et al. 2014).
- The climate-related studies have focused on the assessment of the earliest possible onset of shallow permafrost growth and freezing of the barrier structures in SFR. This is considered to be the most crucial aspect given the shallow repository depth, the radioactivity in the waste and the properties of the barriers in SFR.
- The radionuclide inventory has been updated (SKB 2013a, SKBdoc 1481419 (Mo-93)). The activities of organic and inorganic C-14 have been updated based on measurements performed on

the ion-exchange resins at the nuclear power plants over the last years. SKB has also adjusted the method used for determining the distribution of C-14 between the waste vaults, and the activity is now proportional to the amount of ion-exchange resin deposited. The methods for determining the activity of other nuclides, for example Cl-36, Mo-93, I-129 and Cs-135, have also been improved.

- The assessment methodology has been further developed and is reasonably consistent with the methodology applied in the safety assessment of the repository for spent fuel, SR-Site (SKB 2011).
- A renewed FEP (features, events and processes) analysis has been performed resulting in a FEP catalogue with all FEPs that must be treated in the safety assessment. This is documented in a database. Today SKB's FEP database covers both the spent fuel repository and SFR.
- The initial state, i.e. the state at repository closure, has been described in more detail for example a closure plan has been prepared to provide an integrated account of how the repository is planned to be closed (SKBdoc 1358612).
- Process reports have been produced, where all internal processes identified to be of potential importance for the long-term safety of the repository system are described. Several of the internal processes are studied in more detail than previously, for example detailed water flow in the repository (Abarca et al. 2013, 2014), degradation of cellulose resulting in formation of complexing agents (Keith-Roach et al. 2014), redox evolution in the repository (Duro et al. 2012) and concrete degradation including both chemical degradation and physical/mechanical degradation due to for example the influence of reinforcement corrosion (Höglund 2014).
- Important data has been collected in a dedicated report that includes for example partitioning coefficient values for sorption,  $K_d$  values.
- A number of improvements have been made to the surface system analysis, for example a new digital elevation model and a regolith depth model have been developed. In addition the radionuclide transport model has been enhanced to better represent the transport and accumulation of C-14 in the surface systems.

## 1.6 Report structure

This report is the main report of the assessment of the long-term safety of SFR, SR-PSU. It comprises a description of the assessment and includes conclusions of importance and arguments for compliance with applicable requirements. This main report is part of the SKB applications for licences to extend SFR and to operate the repository. It consists of eleven chapters and nine appendices.

**Chapter 1 – Introduction.** This chapter describes the background and the purpose of the long-term safety assessment and comments on related regulations. In addition, it gives an overview of the SFR repository and the waste.

**Chapter 2 – Methodology.** The chapter provides an overall description of regulatory requirements; also the methodology used for the safety assessment is presented and some aspects, such as time scales, post-closure safety principles, handling of uncertainties, quality assurance and approach to risk calculations are discussed in more detail.

**Chapter 3 – Handling of FEPs.** The chapter describes the methodology for the systematic screening of factors to be taken into account in the assessment in the form of relevant features, events and processes (FEPs). The chapter also describes the handling of internal processes and external conditions that are included in the assessment.

**Chapter 4 – Initial state in the repository and its environs.** The chapter describes the initial state, defined as the expected state of the repository and its environs after closure in 2075. The description of the initial state is based on the technical design of the repository, present-day knowledge concerning conditions in the repository and its environs, and the expected evolution until closure.

**Chapter 5 – Safety functions.** The safety functions are used to describe the long-term function of the SFR repository and its components. They comprise an aid in the formulation of scenarios and in the evaluation of the long-term safety. The chapter describes how the selection of the safety functions for SFR has been done.

**Chapter 6 – Reference evolution.** The chapter describes the reference evolution, defined as a range of possible future evolutions of the SFR repository and its environs. The purpose of the reference evolution is to provide an understanding of the overall future evolution of the repository system including uncertainties of importance for the long-term safety of the repository.

**Chapter 7 – Selection of scenarios.** The chapter presents a main scenario based on the reference evolution and describes how additional scenarios for the safety assessment are selected based on safety functions. The chapter demonstrates how uncertainties in initial state, internal processes and external conditions are addressed in the selection of scenarios.

**Chapter 8 – Description of calculation cases.** The chapter describes the radionuclide transport and dose calculation cases that have been identified to analyse the scenarios (presented in Chapter 7). The chapter also includes a brief description of the modelling approach for the repository (near-field), rock (geosphere/far-field) and surface system (biosphere).

**Chapter 9 – Radionuclide transport and dose calculations.** The chapter describes the results from the calculations of doses to humans and the environment. These results underpin e.g. the assessment of risk.

**Chapter 10 – Assessment of risk.** The chapter presents the results of the safety assessment with the aim to demonstrate how the existing SFR repository, and its extension, will provide adequate long-term protection for human health and the environment. This is done by showing that the repository meets the relevant regulatory risk criteria and requirements defined in SSMFS 2008:21 and 2008:37 for different time periods after repository closure.

**Chapter 11 – Conclusions, further research needs and requirements on design, construction, operation and wastes.** The chapter presents conclusions and remaining issues identified during the work on the safety assessment. The chapter also presents requirements on operation and design, and lists the barriers (both engineered and natural) of importance for long-term safety.

**Appendix A – Compliance with requirements from SSMFS 2008:21 in SR-PSU.** This appendix describes how the regulations in SSMFS 2008:21, “The Swedish Radiation Safety Authority’s regulations and general advice concerning safety in connection with the disposal of nuclear material and nuclear waste” have been complied with in the assessment.

**Appendix B – Compliance with requirements from SSMFS 2008:37 in SR-PSU.** This appendix describes how the regulations in SSMFS 2008:37, “The Swedish Radiation Safety Authority’s regulations and general advice concerning the protection of human health and the environment in connection with the disposal of spent nuclear fuel and nuclear waste” have been complied with in the assessment.

**Appendix C – Handling of injunctions from SAR-08.** The appendix describes in brief how the injunctions issued by SSM after SAR-08 have been handled. The present report does not comprise the response, however.

**Appendix D – Response to review comments from SAR-08 in SR-PSU.** The appendix summarises how review comments from SAR-08 have been handled in the safety assessment.

**Appendix E – Terms and abbreviations.**

**Appendix F – Tables related to the handling of FEPs.**

**Appendix G – Assessment Modell Flowchart, AMF.** Graphical description of assessment activities.

**Appendix H – Map of the Forsmark area.**

**Appendix I – Requirements on pH and the maximum amount of cellulose in the SFR repository.**

## 2 Methodology

### 2.1 Introduction

This chapter presents the methodology used in the long-term safety assessment SR-PSU. The methodology is based on that used in SKB's most recent safety assessment for SFR, SAR-08 (SKB 2008a) and has been developed to be reasonably consistent with the methodology used for SR-Site (the safety assessment in SKB's application for a licencing of a Spent Fuel Repository, SKB 2011) to the extent that this is appropriate given the very different nature of the two facilities. The main purpose of the long-term safety assessment is to investigate whether the repository is safe from a radiological point of view. In practice, this is done by evaluating the compliance with the risk criteria set by the regulator, see Section 2.2.2.

#### 2.1.1 Post-closure safety

The overall aim in developing a geological repository for nuclear waste is to ensure that the amounts of radionuclides reaching the accessible biosphere are such that possible radiological consequences are acceptably low at all times. Different repository design options have different degrees of containment and isolation capability appropriate to the radioactive waste that they will receive (IAEA 2011). In IAEA (2011) a number of aims for disposal are listed. For SFR, the relevant aims are to inhibit, reduce and delay radionuclide migration.

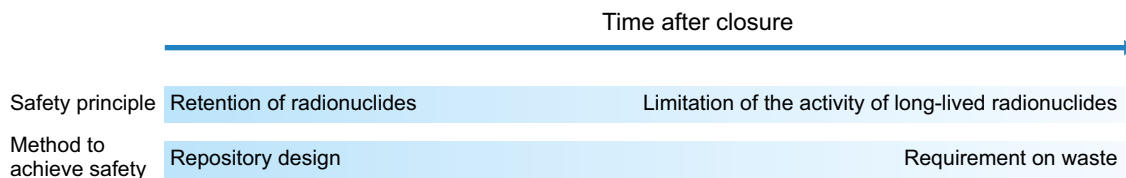
On a national level, regulations stipulate the format and scope of the safety assessment and, in particular, the criteria to be used to assess safety (SSMFS 2008:21 and SSMFS 2008:37). These fundamentals, along with some additional prerequisites concerning the wastes and the design of the repository, are presented in Section 2.2. As described in the general advice on SSMFS 2008:37, post-closure safety should be based on preventing, limiting and delaying the release of radionuclides to the accessible biosphere. This is achieved through a system of passive multi-functional barriers. The barrier system comprises engineered and natural barriers where each barrier contributes to retention of radionuclides, either directly or indirectly by protecting other barriers in the barrier system. Furthermore, the properties and the radionuclide content in the wastes allocated to a repository have to be consistent with design considerations. The location of the SFR repository, initially beneath the sea, contributes to a low hydraulic gradient and prevents inadvertent human intrusion during the early period after closure.

#### 2.1.2 Post-closure safety principles

In order to achieve post-closure safety for the SFR repository system two safety principles have been defined:

- *Limitation of the activity of long-lived radionuclides* is a prerequisite for the post-closure safety of the repository. This is achieved by only accepting certain kinds of waste for disposal. The design of engineered barriers is a consequence of the total activity disposed in each waste vault.
- *Retention of radionuclides* is achieved by the performance of the engineered barriers and the repository environs. The properties of the wastes, together with the properties of the waste containers and of the engineered barriers in the waste vaults, contribute to safety by providing low water flow and a suitable chemical environment to reduce the mobility of the radionuclides. The host rock provides stable chemical and physical conditions and favourable low groundwater flow conditions.

The relative importance of the safety principles as a function of time for the post-closure phase is shown in Figure 2-1. Initially, the design of the repository provides a higher degree of retention than for later times when structures in the repository may degrade. At these later times, the limits placed on the amount of long-lived radionuclides originally disposed in the repository will be essential to ensuring safety. Thus, while *retention of radionuclides* relates to the design of the repository, *limitation of the activity of long-lived radionuclides* relates to the waste.



**Figure 2-1.** Methods to achieve safety on short- and long-term. The figure shows the relative importance of the two safety principles as a function of time for the post-closure phase.

## 2.2 Regulatory requirements

The format and scope of this long-term safety assessment, and specifically the criteria to be used to assess the safety of the repository, are defined in regulations from SSM as described in Section 1.4.

The main regulations are SSMFS 2008:21 concerning *safety in connection with the disposal of nuclear material and nuclear waste* and SSMFS 2008:37 concerning *the protection of human health and the environment in connection with the disposal of spent nuclear fuel and nuclear waste*. Parts of these regulations that influence the methodology applied for the long-term safety assessment are reproduced below.

Essential portions of these documents are reproduced in Appendices A and B. They also indicate how the requirements in the regulations are handled in the long-term safety assessment by reference to relevant sections or through a description directly in the appendices.

### 2.2.1 Time period to be covered by the assessment

The time period to be covered by the assessment is given in Section 10 of SSMFS 2008:21 where it is stated that:

- *A safety analysis shall comprise the requisite duration of barrier functions, though a minimum of ten thousand years.*

The general advice to the regulations states that the time scale for an assessment should be considered in relation to the hazard posed by the repository's radioactive content, in comparison with naturally occurring radionuclides.

The general advice to SSMFS 2008:21 states the following:

- *In the case of periods up to 1,000 years after closure, in accordance with the provisions of SSMFS 2008:37, the dose and risk calculated for current conditions in the biosphere constitute the basis for assessing repository safety and the repository's protective capabilities.*
- *Furthermore, in the case of more extended periods of time, the assessment can be made using dose as one of several safety indicators. This should be taken into account in connection with calculations as well as presentation of analysis results. Examples of these supplementary safety indicators include the concentrations of radioactive substances from the repository which can build up in soils and near-surface groundwater as well as the calculated flow of radioactive substances to the biosphere.*

The general advice to SSMFS 2008:37 states that:

1. *For a repository for spent nuclear fuel or other long-lived nuclear waste, the risk analysis should at least cover approximately one hundred thousand years or the period for a glaciation cycle to illustrate reasonably predictable external strains on the repository. The risk analysis should thereafter be extended in time for as long as it provides important information about the possibility of improving the protective capability of the repository, although for a maximum time period of up to one million years.*
2. *For repositories for nuclear waste other than those referred to in item 1, the risk analysis should at least cover the period of time until the expected maximum consequences in terms of risk and environmental impact have taken place, although for a maximum time period of up to one hundred thousand years. The arguments for the selected limitations of the risk analysis should be presented.*

The general advice to SSMFS 2008:37 also states the following in relation to reporting up to one hundred thousand years:

- *Reporting should be based on a quantitative risk analysis in accordance with the advice on Sections 5 to 7. Supplementary indicators of the repository's protective capability, such as barrier functions, radionuclide fluxes and concentrations in the environment, should be used to strengthen the confidence in the calculated risks.*
- *The given period of time of hundred thousand years is approximate and should be selected in such a way so that the effect of expected large climate changes, for instance a glaciation cycle, on the protective capability of the repository, and the consequences for the surroundings can be illustrated.*

## **2.2.2 Analysis of compliance**

### **Protection of human health**

An overall requirement made on a repository for spent nuclear fuel or nuclear waste is that the repository must satisfy a radiological risk criterion.

SSMFS 2008:37 states the following:

- *A repository for spent nuclear fuel or nuclear waste shall be designed so that the annual risk of harmful effects after closure does not exceed  $10^{-6}$  for a representative individual in the group exposed to the greatest risk. The probability of harmful effects as a result of a radiation dose shall be calculated using the probability coefficients provided by Publication 60, 1990 of the International Commission on Radiological Protection.*

SSM has also issued general advice to the regulations SSMFS 2008:37. One item of advice regarding the criterion for individual risk is that:

- *If the exposed group only consists of a few individuals, the criterion of the regulations for individual risk can be considered as being complied with if the highest calculated individual risk does not exceed  $10^{-5}$  per year.*

### **Protection of the environment**

SSMFS 2008:37 states the following:

- *The final management of spent nuclear fuel and nuclear waste shall be implemented so that biodiversity and the sustainable use of biological resources are protected against the harmful effects of ionising radiation.*
- *Biological effects of ionising radiation in the habitats and ecosystems concerned shall be described. The report shall be based on available knowledge on the ecosystems concerned and shall take particular account of the existence of genetically distinctive populations such as isolated populations, endemic species and species threatened with extinction and in general any organisms worth protecting.*

## **2.2.3 Methodological considerations for the execution of the assessment**

The regulations also include information on the scope of the safety assessment. Specifically, SSMFS 2008:37 states the following:

- *The consequences of intrusion into a repository shall be reported for the different time periods specified in Sections 11 and 12. The protective capability of the repository after intrusion shall be described.*

SSMFS 2008:21 states the following:

*...the safety analyses shall also comprise features, events and processes that can lead to the dispersion of radioactive substances after closure.*

And the appendix of SSMFS 2008:21 states that:

- *The following shall be reported with regard to analysis methods:*
  - *how one or several methods have been used to describe the passive system of barriers in the repository, its performance and evolution over time; the method or methods shall contribute to providing a clear understanding of the features, events and processes that can affect the performance of the barriers and the links between these features, events and processes*
  - *how one or several methods have been used to identify and describe relevant scenarios for sequences of events and conditions that can affect the future evolution of the repository; the scenarios shall include a main scenario that takes into account the most probable changes in the repository and its environment*
  - *the applicability of models, parameter values and other assumptions used for the description and quantification of repository performance as far as reasonably achievable*
  - *how uncertainties in the description of the barrier system's functions, scenarios, calculation models and calculation parameters as well as variations in barrier properties have been dealt with in the safety analysis, including the reporting of a sensitivity analysis showing how the uncertainties affect the description of the evolution of barrier performance and the analysis of the impact on human health and the environment*
- *The following shall be reported with respect to the analysis of post-closure conditions:*
  - *the safety analysis in accordance with Section 9 comprising descriptions of the evolution in the biosphere, geosphere and repository for selected scenarios; the environmental impact of the repository for selected scenarios, including the main scenario, thereby considering defects in engineered barriers and other identified uncertainties.*

## 2.2.4 Design and best available technique

Another overall requirement concerns adoption of an optimal radiation safety approach and consideration of best available technique (BAT).

Section 4 of SSMFS 2008:37 states that:

- *Optimisation must be performed and the best available technique shall be taken into consideration in the final management of spent nuclear fuel and nuclear waste. The collective dose, as a result of the expected outflow of radioactive substances over a period of 1,000 years after closure of a repository for spent nuclear fuel or nuclear waste shall be estimated as the sum, over 10,000 years, of the annual collective dose. The estimate shall be reported in accordance with Sections 10 to 12.*

## 2.3 Safety assessment

In order to assess the safety of the repository system, its future evolution must be evaluated. The repository system is defined as the repository and its environs. The repository consists of deposited waste, waste packaging, engineered barriers and other repository structures. The repository environs consist of the host rock surrounding the repository and the biosphere above the repository. The evaluation of the future evolution of the repository system is starting at repository closure. The evolution will depend on:

- **The Initial state of the repository system.** The initial state is defined as the state of the repository system at closure. In order to describe the initial state, the reference design and evolution of the repository system during the operational phase need to be considered.
- **External conditions acting on the repository system after closure.** External processes include climate and climate-related processes, for example permafrost and shoreline displacement and the current process of global warming. Future human actions may also affect the future state of the repository.
- **Internal processes within the repository system.** Internal processes include thermal, hydraulic, mechanical and chemical processes that act in the repository system. Internal processes include, for example, groundwater flow and chemical degradation affecting the engineered barriers. Another example is production of gas as a result of corrosion of metals.



Based on this information, the evolution of the repository system is estimated. By combining this with an analysis of future exposures, radiological risks to humans and the environment can be estimated.

### **2.3.1 Timescale for the assessment**

SFR is designed for the safe disposal of operational and decommissioning wastes from nuclear power plants and other nuclear facilities. As a result of radioactive decay, only about 2 percent of the radio-toxicity remains 1,000 years after closure. After 100,000 years, less than 0.1 percent of the radio-toxicity remains; see Section 1.3.3. During the initial 1,000 years when the repository is submerged under the sea, the hydraulic gradient in the bedrock is low and the risk of inadvertent intrusion is limited. However, as time progresses, the shoreline will pass over the repository and this situation will change.

The requirement on the assessment period is described in SSMFS 2008:21 and SSMFS 2008:37, see Section 2.2.1. A safety assessment for waste that is neither spent fuel nor long-lived radioactive material shall be carried on for as long as the barriers are required, but at least for 10,000 years. The regulation states also that the assessment should extend to at least the time until the expected maximum consequences regarding risk and environmental impact have occurred, but no longer than a time span of up to one hundred thousand years.

In the present assessment, the safety of the facility is evaluated over a period up to 100,000 years. Showing that the radiological consequence of the repository is negligible after 100,000 years provides arguments for the length of the chosen assessment period. In addition, the radiological risk after a glaciation is assessed, regardless of the timing of such an event.

#### ***Timescale relevant for repository evolution***

According to the regulations and associated guidelines, two time periods must be included in the safety assessment. One period is to cover the first 1,000 years after closure when the safety assessment can be based on reliable information in terms of initial state and climatic and biosphere data, whereas the second covers the rest of the assessment period up to 100,000 years.

During the assessment period, the external conditions will change. The position of the shoreline will change due to a combination of eustatic changes, i.e. changes in sea level, and isostatic changes in the form of vertical movement of the Earth's crust which, in Forsmark, is dominated by glacial rebound. Hence, for the evolution of the repository, the following time periods related to the shoreline position are relevant:

- The period when the repository is located beneath the sea.
- The period when the repository and areas above the repository are affected by the movement in the position of the shoreline.
- The period when the repository is located so far inland of the shoreline that steady-state conditions prevail at repository depth.

The shoreline position will affect the flow and chemistry of groundwater around the repository and the likelihood for inadvertent intrusion, predominantly through well drilling. In addition, the climate will change during the assessment period. For the evolution of the repository, the following time periods related to climate are relevant:

- Periods when temperate climate conditions prevail. During these periods, the repository may be submerged by sea, as today, or alternatively, under land.
- Periods when periglacial climate conditions prevail with presence of permafrost at the surface and within the geosphere. During these periods the repository is under land.
- A period of glacial climate conditions followed by a post-glacial period. During the post-glacial period the repository is first submerged and subsequently under land.

In summary, the various processes and events occurring during the periods outlined above provide a well-defined basis for the description of the thermal, hydrological, mechanical and geochemical evolution of the repository system over the time periods considered in the safety assessment.

The starting point of the safety assessment is the Initial state, defined as the condition of the repository and its environs at closure, see Figure 2-2. It is defined based on the Reference design, but it also reflects the development of the repository system during the operational phase up to closure. The evolution of the repository during the operational phase is relatively well known and measures to limit degradation can be taken. The Initial state is described in Chapter 4. The evolution during the post-closure phase until a glaciation occurs is described in the Reference evolution, see Chapter 6. Due to the large uncertainties, the evolution of the repository system after a glaciation is described in a simplified manner.

In the event of ice-sheet growth and decay above SFR, the repository system is affected to such a degree that it cannot be described and analysed in detail. Consequently, the repository evolution during glacial and post-glacial conditions is evaluated in a simplified manner.

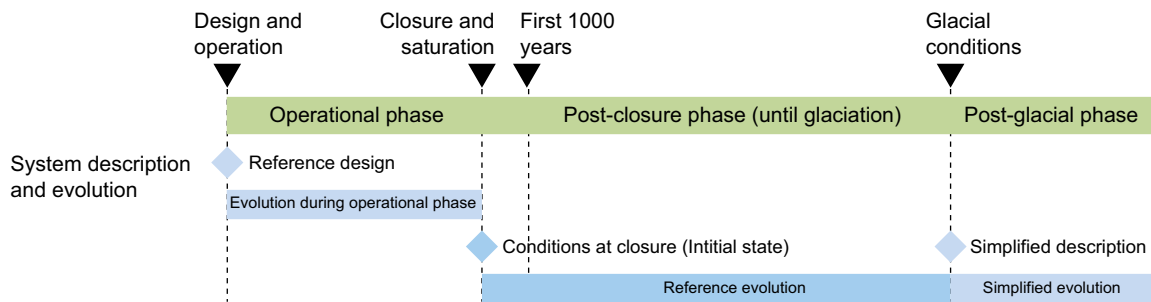
### ***Timescales relevant for the radionuclide inventory***

The decay of the radionuclide inventory in SFR with time is shown in Figure 1-5. Radionuclides with a half-life less than 31 years are denoted as short-lived while radionuclides with a half-life exceeding 31 years are denoted long-lived<sup>3</sup>. Only a limited amount of these long-lived radionuclides are accepted in the wastes disposed or to be disposed in SFR. These radionuclides will however be those contributing to the radiological risk at longer times. For the discussions in this report, a categorisation of radionuclides, based on their half-lives, is used:

- Short-lived radionuclides with a half-life less than 10 years. These radionuclides are not included in the radionuclide transport calculations, as they will decay during the operational and resaturation period. In order to show compliance to the risk criteria the radiological consequence of these very short-lived (from the perspective of geological disposal) radionuclides must naturally be assessed. However, the radiological consequence is estimated using a simplified model. One radionuclide belonging to this category is Co-60.
- Short-lived radionuclides with a half-life longer than 10 years but less than 31 years are included in the radionuclide transport calculations. These radionuclides will decay to insignificant levels within a relatively short time period, i.e. about 10 half-lives of these short-lived radionuclides coincides with the time period for which institutional control, internationally, is foreseen to contribute to safety. Examples of radionuclides belonging to this category are Sr-90 and Cs-137.
- Long-lived radionuclides with a half-life short enough to decay substantially during time periods of relevance for the design of the repository and/or the safety assessment. Time periods of relevance are, for instance, the time period when the shoreline passes over the repository, the time period until a well for drinking water may be drilled into or downstream of the repository, the time period until the concrete barriers totally degrade and lose their function, and the time period until permafrost reaches repository depth. Examples of radionuclides belonging to this category are Ni-63, Am-241, C-14 and Mo-93.
- Long-lived radionuclides with a half-life so long that they will not decay substantially during the overall time period of this analysis. Examples of such radionuclides are Ni-59, Cl-36, I-129, U-238 and its daughters.

---

<sup>3</sup> Short-lived waste is defined according to the IAEA Safety Glossary, 2007 Edition (IAEA 2007) as “radioactive waste that does not contain significant levels of radionuclides with half-lives greater than 30 years”. SKB uses the same definition but with 31 years to include cesium-137, which is used as a key radionuclide to estimate the content of other radionuclides. Waste that is not short-lived is consequently considered long-lived.



**Figure 2-2.** Steps needed for assessing the long-term safety. Activities shown in blue are included in the long-term safety assessment.

### 2.3.2 Approach to show compliance

SSM has established criteria against which the results of risk calculations should be compared in order to ascertain whether the repository can be considered safe. These requirements are given as permissible risk limits for man, but also as qualitative criteria for the environment. The repository may not adversely affect biodiversity or the sustainable use of biological resources. Evaluation against these environmental criteria is further described in Chapter 10.

#### **Protection of human health**

SSM (SSMFS 2008:37) stipulates that the annual risk of harmful effects may not exceed  $10^{-6}$  for a representative individual in the group exposed to the highest risk from the repository (the most exposed group). This gives an annual effective dose of  $14 \mu\text{Sv}$ , where the conversion to dose uses a risk factor of 7.3 percent per Sv (as given in the regulation). This criterion applies if the exposed group is relatively large. If the exposed group consists of a few individuals, the annual risk to the most exposed individual can then be evaluated against a risk criterion of  $10^{-5}$  per year, which is equivalent to an annual effective dose of  $140 \mu\text{Sv}$ .

SSM also stipulates that the risk should be calculated as an annual average of lifetime exposure/dose. In accordance with the ICRP's (ICRP 2000, 2006) recommendations, SKB has calculated the lifetime dose based on exposure of an adult individual in the most contaminated area. The lifetime dose has been calculated as a mean value over 50 years, which is the integration period the ICRP uses to derive dose coefficients for internal exposure of adult individuals. All exposure pathways deemed to be relevant have been taken into account in the dose calculations.

In the assessment, a number of scenarios are defined in order to describe future potential evolutions of the repository, see further Section 2.4.8. For each of these, radiological consequences have been calculated. In the calculations, a probabilistic method has been used where the probability distributions of the input data reflect both uncertainties and known variabilities. A number of realisations have been carried out. The result is a statistical distribution of doses as a function of time, where the mean value of the distribution has been used for comparison with the criterion. This is called a conditional risk, since it assumes that the scenario in question has occurred. The unconditional risk is obtained by multiplying the conditional risk by the probability that the scenario actually occurs. In the determination of the total risk, the risks of the scenarios are weighted together, taking into account possible combinations of scenarios.

The approach taken in the risk evaluation is to:

1. calculate the conditional risk, i.e. based on the mean dose for each calculation case.
2. weight the results from the different calculation cases by their probabilities of occurrence to obtain a total risk estimate as a function of time.
3. compare the estimated time-dependent risk with the risk criteria in the regulations.

SSM's regulations also require that the issue of risk dilution is addressed, i.e. situations where a probabilistic approach tends to spread an exposure that will occur at a certain point in time over several future generations, since the time of occurrence is uncertain. Risk dilution is addressed in Chapter 10.

### **Protection of the environment**

There is, at present, no limiting value for exposure of animals and plants stipulated in SSM's regulations, nor is there any international consensus on a value that should be used (see further discussion in the **Radionuclide transport report**<sup>4</sup>). Rather, the consensus is to apply an approach whereby a screening value (or range) is applied; if dose rates are predicted or calculated to be above such a value or range, it is assumed that there is the possibility of negative effects to a population of organisms and further assessment is thus warranted.

A number of screening values have been suggested, from the ICRP and other organisations (US Department of Energy, IAEA and UNSCEAR), and in a series of EU-projects (EPIC, FASSET, ERICA, PROTECT). To maintain a conservative assessment, the results in this safety assessment have, in general, been compared with the most restrictive screening value,  $10 \mu\text{Gy}\cdot\text{h}^{-1}$ , as used in the ERICA model (Beresford et al. 2007). However, the ICRP (ICRP 2014) recommends some derived consideration reference levels (DCRLs) that are to be used for screening, which are lower than the ERICA screening values. SKB has therefore compared the assessment results with these DCRLs for the types of organisms for which these are lower than the ERICA screening values.

### **2.3.3 Methodological considerations**

The role of the analysis of the long-term safety in the iterative process which continues during the design, construction and operational phases of a repository are illustrated in Figure 2-3. The present safety assessment is based on waste volumes and activities presented in completed decommissioning studies for the Swedish nuclear power plants, estimates for future operational wastes and a preliminary design of the SFR extension. One result from the safety assessment is preliminary requirements related to the construction and operation of the repository.

### **Preliminary requirements and restrictions**

In Chapter 11, preliminary requirements on the design and waste based on the result of the assessment are presented. Requirements on and descriptions of the wastes will continue to be refined and uncertainties of relevance for the safety of the repository system will hence be reduced. Also, the design of the repository will become more detailed and further adapted to the requirements that emerge from iterative assessments of long-term safety.

### **Information used in the present assessment**

The initial state of the repository is presented in Chapter 4. As the plans for decommissioning of the nuclear power plants become more detailed, the decommissioning studies and the information that serves as a basis for them will be updated along with the inventory, providing important information about the initial state. Similarly, the repository design will become more detailed and acceptance criteria for the future wastes will be updated and refined.

In addition to information from decommissioning studies, estimates for future operational wastes and a preliminary design, the present safety assessment is based on the following assumptions which have to be considered in future waste acceptance criteria and taken into account or revised in future design steps and safety assessments for the repository:

- The load exerted by swelling waste will not damage the grout and the barriers in 1BMA and 2BMA.
- The quantity of reactive metals is so low that the barriers are not damaged by gas, mainly produced by metal corrosion.
- The pH in BMA is maintained at such a level that microbial degradation of C-14-containing waste is kept so low that release of C-14 as methane gas will not be a dominant transport pathway.

---

<sup>4</sup> Abbreviation in bold used to refer to Main References, see Section 2.5.

- The quantity of cellulose in the waste is limited. The reason is that the quantity of cellulose should not give rise to such high concentrations of the complexing agent isosaccharinate (ISA) that it adversely affects the sorption of radionuclides.
- There is a continuing discussion about the radionuclide inventory of S.14 waste between SKB and SSM. In the present assessment, the S.14 waste in 1BLA and the information on radionuclides and materials used as input data are taken from SKB's waste database, where documentation of waste disposed in SFR is stored.

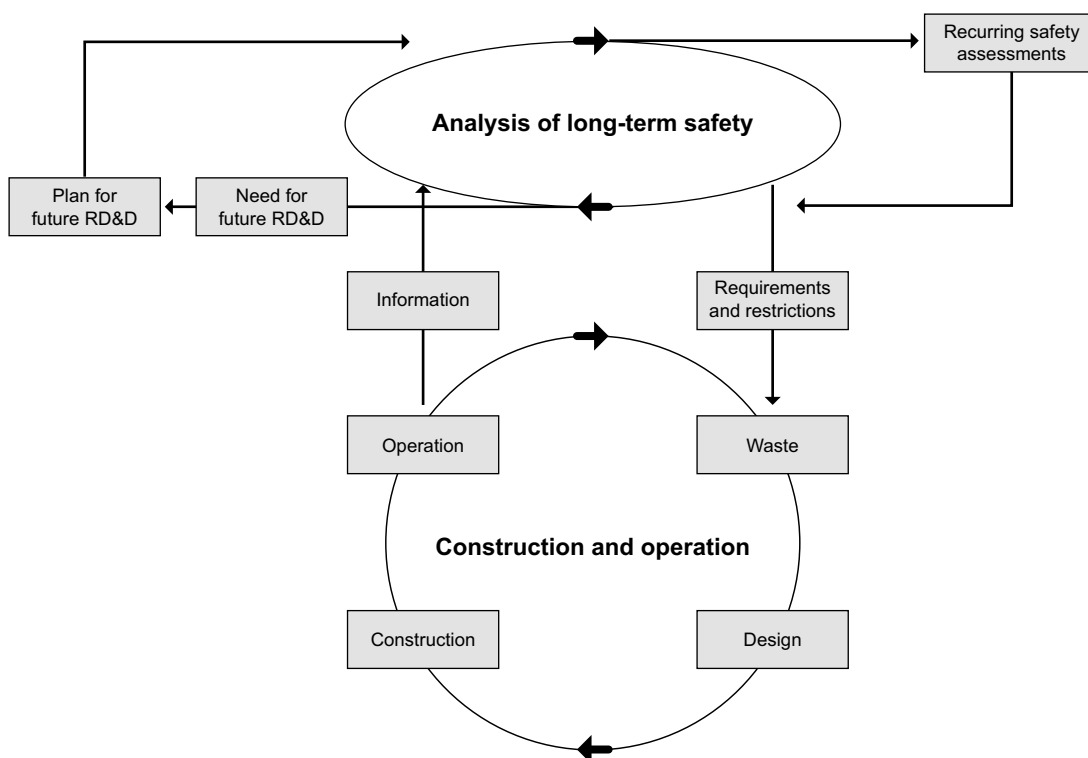
An additional assumption for the safety assessment is that the initial state of the 1BMA structures, which is based on a number of measures to be taken as presented in the **Initial state report**, can actually be achieved.

### **Need for future RD&D**

Topics for further research identified during the work on the safety assessment are presented in Chapter 11. These provide important feedback and input to SKB's RD&D programme.

### **Recurring safety assessments**

The present document together with the analysis of operational safety, constitute the first preliminary safety analysis report (F-PSAR) for the extended SFR. It is part of SKB's applications for licences to extend and operate SFR. After the Government has issued a license, SKB must submit a preliminary safety analysis report (PSAR) to SSM. SSM has to approve the report prior to the start of construction of the extension of SFR. The PSAR must subsequently be updated and approved by SSM before start of trial operation and routine operation, respectively. After that, the safety analysis report shall be regularly updated during the operational phase (SSMFS 2008:1). Prior to repository closure it shall be renewed and subjected to a safety review (SSMFS 2008:21).



**Figure 2-3.** The role of long-term safety assessment during design, construction and operational phases of the repository. Construction and operation of the SFR facility affects the basis for the analyses of the operational and long-term safety of the facility. The outcome of the analyses may define new or modified requirements on the design and waste. This in turn will affect the construction and operation of the repository.

### 2.3.4 BAT and optimisation

According to Swedish legislation, a licence application for a final repository needs to address the issues of best available technique (BAT) and optimisation to keep the radiation doses to humans as low as reasonably achievable. The general account as to how BAT is addressed is given in a dedicated Annex to the licence application (SKBdoc 1415420). To comply with the detailed regulations regarding long-term safety issued by SSM, some aspects of the demonstration of BAT need to be addressed in the assessment of the long-term safety.

Overall, demonstration of the use of BAT is a broad issue and the safety related issues very much relate to the location of the repository and to the design of the different parts.

The regulations require that BAT is used and that siting, design, construction and operation of the final repository and appurtenant system components are selected to *prevent, limit and retard* releases from both engineered and geological barriers as far as is *reasonably* achievable. What is considered reasonable is discussed in the dedicated Annex to the licence application (SKBdoc 1415420). Factors of importance for the retention capacity include what amounts of cellulose can be considered reasonable, what amounts of gas-producing materials can be permitted without damage to the barriers, etc. In order for the repository to be regarded as a *repository for short-lived waste*, requirements must also be stipulated on what quantities of long-lived waste can be accepted in the repository. Besides a discussion regarding BAT and reasonableness, assumptions made in the assessment can result in requirements on design and on the waste. Figure 2-3 illustrates this iterative process, where the construction and operational procedures are based on requirements on long-term safety of the facility. The issue of optimisation in the long-term safety assessment is closely related to the evaluation of doses and risks after closure, as well as to feedback from the assessment to repository design. BAT and optimisation are further discussed in Chapter 11.

## 2.4 Methodology in ten steps

The methodology applied for the long-term safety assessment SR-PSU consists of ten main steps described in the following subsections. The assessment methodology has been developed since the most recent safety assessment for SFR, SAR 08 (SKB 2008a), and is reasonably consistent with the methodology applied in the safety assessment of the repository for spent fuel, SR-Site (SKB 2011). A graphical illustration of the ten steps is shown in Figure 2-4.

### 2.4.1 Step 1: Handling of FEPs

This step in a safety assessment is to identify all factors that are important for the evolution of the repository and its environs that need to be considered in order to gain a good understanding of the evolution and safety of the repository. This is done in a screening of potentially important features, events and processes (FEPs). Experience gained from previous safety assessments of SFR, including SAR-08, and international databases of relevant FEPs that affect long-term safety are utilised for this. SKB has a FEP database that was originally developed for a repository for spent nuclear fuel. This database has, through the implementation of SR-PSU, been further developed to include also the SFR repository.

Most of the FEPs in the database are classified as i) initial state FEPs, ii) internal processes or iii) external FEPs. The remaining FEPs are either related to the assessment methodology in general or have been found to be irrelevant to SFR. Based on the results of the FEP processing, a specific SFR FEP catalogue has been compiled and it contains the FEPs that are to be further handled in SR-PSU.

This step of FEP processing is further described in Chapter 3 and in the **FEP report**.

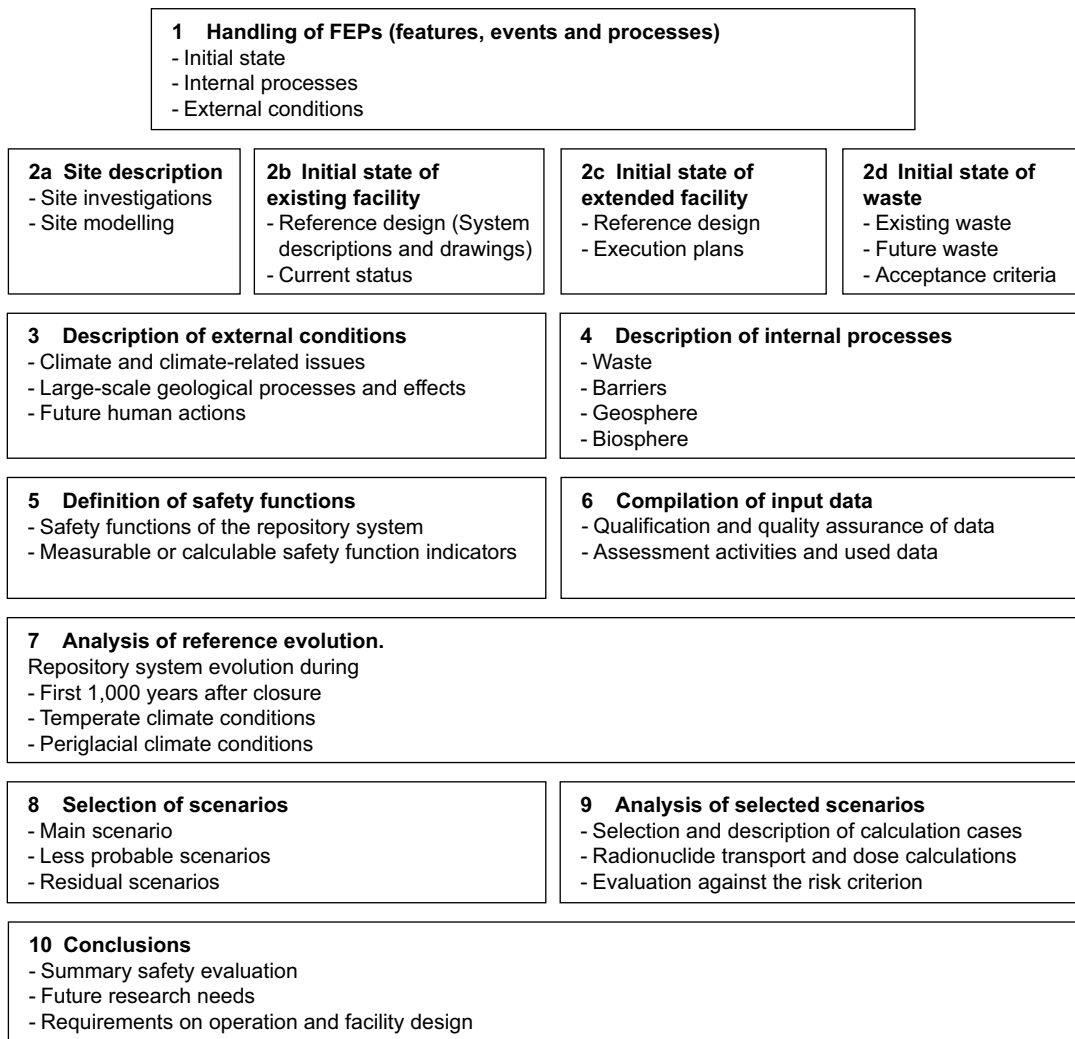


Figure 2-4. Overview of the ten steps in the methodology used for the long-term safety assessment SR-PSU.

## 2.4.2 Step 2: Description of initial state

The initial state is defined as the expected state of the repository and its environs at closure. The initial state is fundamental to the safety assessment and requires thorough substantiation. The initial state of the repository part currently in operation (SFR 1) is based on verified and documented properties of the wastes and the repository and an assessment of how these will change up to the time of closure, whereas the initial state of the extension (SFR 3) is mainly based on the reference design and present waste prognosis, see the **Initial state report**. The environs of the repository at closure are assumed to be similar to those of today, as described in a site descriptive model, SDM-PSU, see SKB (2013e) and the **Biosphere synthesis report**. The SDM-PSU is based on the result of the site characterisation work performed during site investigations and includes data from the bedrock and the near-surface systems. A summary of the initial state of the repository system is given in Chapter 4.

The FEP processing performed in Step 1 resulted in identification of a number of FEPs related to the initial state as being of relevance. These are covered in the description of the initial state. There are also FEPs that relate to potential deviations from the initial state and that require separate assessment. These are discussed in Section 3.3.

### 2.4.3 Step 3: Description of external conditions

Factors related to external conditions are divided into three categories “climate and climate-related issues”, “large-scale geological processes and effects” and “future human actions (FHAs)”.

The most important part of the description of external conditions is the formulation of well-founded future evolutions of the climate and climate-related processes. These evolutions are based on current scientific knowledge concerning the Earth’s climate. There are four climate evolutions, or climate cases, included in the safety assessment.

The *global warming climate case* describes a climate evolution influenced by moderate global warming combined with small variations of incoming solar radiation.

The *early periglacial climate case* describes limited global warming. This climate case includes the earliest potential timing of the occurrence of permafrost development in Forsmark.

The *extended global warming climate case* describes significant global warming and is the bounding case for a maximum duration of temperate climate conditions.

The *Weichselian glacial cycle climate case* represents a climate entirely dominated by natural climate variability as reconstructed for the last glacial cycle. This development includes ice-sheet development.

This step is mainly documented in the **Climate report** and supports the analyses of the reference evolution as described in Step 7.

Future human actions are analysed by first identifying FEPs relevant at the site. The FEPs are then used to set up stylised FHA scenarios of which some are analysed quantitatively and others qualitatively. The FHA methodology and scenarios are described in the **FHA report** and the stylised scenarios are described in Chapter 7.

### 2.4.4 Step 4: Description of internal processes

The FEP processing (Step 1) gave rise to a number of processes judged to be relevant to the evolution of the repository system. All processes identified to be of potential importance for the long-term safety of the repository system are described in the **Waste process report**, the **Barrier process report**, the **Geosphere process report**, the **Biosphere synthesis report** and in SKB (2013c).

Each process is documented in the process reports according to a template with a number of set headings. At the end of the process documentation, it is established how the process is to be handled in the safety assessment, a central result from the process reports. The process reports thus provide a “recipe” for handling the different processes in the assessment.

The handling of all processes in the process reports is summarised in tables that describe whether a process can be neglected, whether a qualitative assessment is made, or whether it is handled by quantitative modelling. These tables are also provided in Appendix F.

Several of the processes are handled through quantitative modelling, where each model, in general, includes several interacting processes, often occurring in different parts of the repository system and hence described in different process reports.

The models form a network, where the results from one model are used as input to another. The network of models is described graphically by an Assessment Model Flowchart (AMF, see Appendix G) and an associated AMF table linking the processes in the process tables, the models in the AMF, and the reporting of the modelling in this main report. Further description of the compilation of the process reports and the resulting process tables, the AMF chart and the AMF table is provided in Section 3.3 and Appendix G.



As mentioned in Section 2.3, in the event of ice-sheet growth and decay above SFR, the repository system is affected to such a degree that it cannot be described and analysed in detail. Therefore, the event of ice-sheet development and the evaluation of the repository system thereafter are assessed in a simplified way in SR-PSU.

#### 2.4.5 Step 5: Definition of safety functions

A central element in the methodology is the definition of safety functions. The safety functions describe long-term functioning of the repository and its components and are an aid in the formulation of scenarios.

This step consists of identifying and describing the repository system's safety functions and how they can be evaluated with the aid of a set of safety function indicators that consist of measurable or calculable properties of the wastes, engineered barriers, geosphere and surface system.

As previously described, there are two overall safety principles for SFR – *limitation of the activity of long-lived radionuclides and retention of radionuclides* (see Section 2.1.2). The overall safety principles are broken down and described in terms of a number of specified safety functions and safety function indicators in Chapter 5. An example is the bentonite surrounding the silo, which contributes to the retention of radionuclides by restricting the water flow through the waste and thereby the transport of radionuclides from the repository. The corresponding selected safety function is the ability to restrict advective transport and the safety function indicator is the hydraulic conductivity of the bentonite. The fact that a safety function deviate from its expected status does not necessarily mean that the repository does not comply with regulatory requirements, but rather that more in-depth analyses of the issue and additional data are needed to evaluate safety.

#### 2.4.6 Step 6: Compilation of input data

In this step, all data to be used in the quantification of repository evolution and in radionuclide transport and dose calculations are selected using a structured process.

The selection of data is determined by the conditions that exist over the period of relevance, as well as the identified safety functions and their longevity of applicability, as reported in the **Data report** and in Grolander (2013). These reports describe how essential data for the long-term safety assessment of the SFR repository are selected, justified and qualified through traceable standardised procedures.

Additionally, in this assessment, there is a further report, the **Input data report**, where the data actually used in the different assessment activities related to later methodology steps are compiled.

#### 2.4.7 Step 7: Analysis of reference evolution

In this step, the external conditions and internal processes, identified in previous steps to be of importance for the evolution of the repository and its environs, are evaluated. To this end, a reference evolution is defined based on a range of possible future evolutions of the SFR repository system based on likely processes and events relevant for the long-term safety of the SFR repository. This step is described in Chapter 6. The initial state (Step 2) together with external conditions (Step 3) and internal processes (Step 4) that are likely to influence the evolution serve as inputs to the reference evolution.

The description of the reference evolution of the SFR repository and its environs has been divided into three parts. The first of these parts is the evolution until around 1,000 years after closure during which the climate is expected to remain temperate and the engineered barriers are expected to retain their properties. This early evolution is based on quantitative analyses and is described in detail as required by the regulation (SSMFS 2008:37). During the remaining time until around 100,000 years after closure the climate is expected to change, the shoreline will be considerably displaced and the engineered barriers will degrade. The description of the evolution for this period has been divided into one part addressing the impact on the repository of processes and events likely to occur during temperate climate conditions and a second part addressing the impact on the repository of processes and events likely to occur during periglacial climate conditions.

### 2.4.8 Step 8: Selection of scenarios

SSM's Regulations SSMFS 2008:21 require that scenarios are used to describe future potential evolutions of the repository and that among these there should be a main scenario that takes into account the most likely changes within the repository and its environs. The general advice concerning SSMFS 2008:21 describe three different categories of scenarios:

- main scenario,
- less probable scenarios,
- other scenarios or residual scenarios.

The selection and description of scenarios are presented in Chapter 7. The descriptions include information on the status of the safety function indicators. The main scenario is based on the probable evolution of external conditions, and realistic, or, where justified, pessimistic assumptions with respect to the internal conditions, as described in the reference evolution (Step 7). It is also based on the initial conditions specified in Chapter 4 (Step 2). In summary, the description of the main scenario comprises descriptions of external conditions, the evolutions of the geosphere, the repository and the surface system as well as data needed and the approach chosen for radionuclide transport modelling.

Based on the reference evolution, a number of less probable scenarios that may be of importance for the long-term safety of the repository are selected. To do this, possible routes to violation of each safety function (presented in Table 5-3) are identified with the aid of the safety function indicators. To this end, uncertainties in initial state, internal processes and external conditions are identified to assess if there is a possibility that the status of the safety function deviates from that in the main scenario in such a way that a lower degree of safety is indicated. Thereby an alternative evolution of the repository system deemed to be of importance for the long-term function of the repository is identified. The selection and descriptions of the less probable scenarios are found in Chapter 7.

The set of residual scenarios consists of scenarios chosen in order to illustrate the significance of individual barriers and barrier functions, damage to humans intruding into the repository and the consequences of an unclosed repository, and, consequences of external conditions within the range defined by the SR-PSU climate cases that are not included in the main scenario. The residual scenarios are analysed regardless of their probability.

### 2.4.9 Step 9: Analysis of selected scenarios

#### ***Selection and description of calculation cases***

To judge radiological consequences, the scenarios have to be evaluated with the aid of calculation cases that are analysed with mathematical models. The way in which the calculation cases are defined and set-up is briefly described in this step, see further Chapter 8.

The calculation cases have been divided into groups, corresponding to the three scenario categories: main scenario, less probable scenarios and residual scenarios, and, scenario combinations.

#### ***Radionuclide transport and dose calculations***

This step comprises the quantitative calculation of radionuclide transport from the repository (near-field) through the rock (geosphere/far-field) to the surface system (biosphere) and evaluation of the doses that humans and biota can incur from exposure to repository derived radionuclides, see Chapter 9 and the **Radionuclide transport report**.

Input data to the calculations are selected in this step. An uncertainty assessment is performed for certain input data that have been found in the previous safety assessment, SAR-08, to be of importance to the results. This uncertainty assessment provides a parameter value interval or distribution that is used for probabilistic calculations.

### ***Evaluation against the risk criterion***

The risk is estimated for the main scenario and for the less probable scenarios, see Chapter 10. The risk for a scenario is calculated by multiplying the probability of the scenario by the calculated dose consequence. The estimated risk is compared with SSM's risk criterion, see further Step 10. The main scenario and the less probable scenarios are included in the summation of risk for the repository.

In accordance with the regulatory requirements, a set of residual scenarios is selected as described in Step 8. According to the regulations and general advice, no probability estimates are made for these scenarios and they are not included in the summation of risk for the repository.

## **2.4.10 Step 10: Conclusions**

### ***Summary safety evaluation***

The assessment of the long-term safety of SFR is based on an integrated evaluation of both quantitative and qualitative results. Calculated doses and risk estimates are compared with criteria stipulated in SSM's regulations. The long-term protective capability of the different repository components including waste and rock is evaluated on the basis of results of the analysis of repository evolution, see Chapter 11.

### ***Future research needs and requirements on operation and facility design***

Since the results of the safety assessment depend on the initial state of the repository system being analysed, and on the understanding of internal and external processes, the discussion of confidence in the results is also based on confidence in the initial state description and of the understanding of the processes that act on the system.

For the safety assessment to be valid, the operator must ensure that the repository system at closure will correspond to the assumed initial state in the safety assessment. This is achieved by formulating a number of requirements on e.g. design premises and waste with which the operator must comply.

In order to deepen understanding and reduce uncertainties, additional research will have to be done also after the applications for licencing is completed. In order to reduce uncertainties in the initial state for the extension and unfilled parts of the existing facility, the safety assessment can stipulate requirements on execution and design. Requirements may also have to be formulated as to the properties of the waste.

## **2.5 Report hierarchy in the SR-PSU safety assessment**

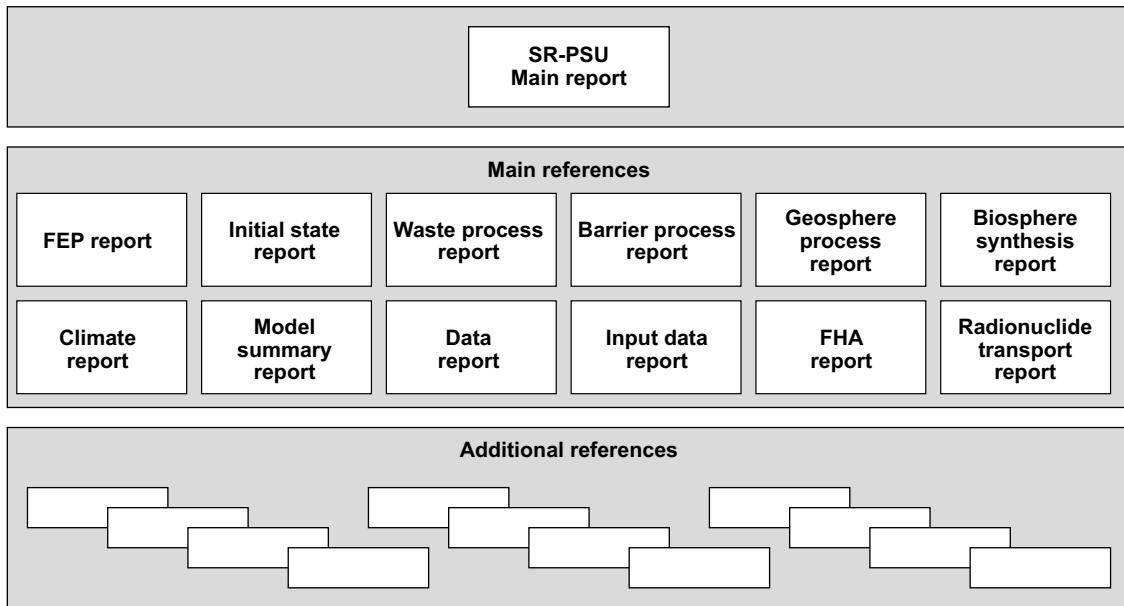
The methodology is reflected in the structure of this Main report. Several of the steps carried out in the safety assessment are described in more detail in specific reports that are central for the conclusions and analyses in this Main report. Table 2-1 lists these Main references and defines the abbreviations by which they are identified in the text (**abbreviated names in bold font**). This Main report is, together with the twelve Main references, part of the applications for licencing of the extension and the continued operation of SFR.

There are also a large number of Additional references. The Additional references include documents compiled within the SR-PSU assessment, but also documents compiled outside of the project, either by SKB or equivalent organisations as well as in the scientific literature. Additional publications and other documents are referenced in the usual manner.

A schematic illustration of the safety assessment documents is shown in Figure 2-5.

**Table 2-1. Main references in the SR-PSU. All these reports are available at [www.skb.se](http://www.skb.se)**

Abbreviation used when referenced in this report	Text in reference list	Comment on content
Barrier process report	<b>Barrier process report, 2014.</b> Engineered barrier process report for the safety assessment SR-PSU. SKB TR-14-04, Svensk Kärnbränslehantering AB.	Describes the current scientific understanding of the processes in the engineered barriers that have been identified in the FEP processing as potentially relevant for the long-term safety of the repository. Reasons are given in the process report as to why each process is handled a particular way in the safety assessment.
Biosphere synthesis report	<b>Biosphere synthesis report, 2014.</b> Biosphere synthesis report for the safety assessment SR-PSU. SKB TR-14-06, Svensk Kärnbränslehantering AB.	Describes the handling of the biosphere in the safety assessment. The report summarises site description and landscape evolution, FEP handling, exposure pathway analysis, the radionuclide model for the biosphere, included parameters, biosphere calculation cases and simulation results.
Climate report	<b>Climate report, 2014.</b> Climate and climate-related issues for the safety assessment SR-PSU. SKB TR-13-05, Svensk Kärnbränslehantering AB.	Describes the current scientific understanding of climate and climate-related processes that have been identified in the FEP processing as potentially relevant for the long-term safety of the repository. The report also describes the climate cases that are analysed in the safety assessment.
Data report	<b>Data report, 2014.</b> Data report for the safety assessment SR-PSU. SKB TR-14-10, Svensk Kärnbränslehantering AB.	Qualifies data and describes how data, including uncertainties, that are used in the safety assessment are quality assured.
FEP report	<b>FEP report, 2014.</b> FEP report for the safety assessment SR-PSU. SKB TR-14-07, Svensk Kärnbränslehantering AB.	Describes the establishment of a catalogue of features, events and processes (FEPs) that are of potential importance in assessing the long-term functioning of the repository.
FHA report	<b>FHA report, 2014.</b> Handling of future human actions in the safety assessment SR-PSU. SKB TR-14-08, Svensk Kärnbränslehantering AB.	Describes radiological consequences of future human actions (FHA) that are analysed separately from the main scenario.
Geosphere process report	<b>Geosphere process report, 2014.</b> Geosphere process report for the safety assessment SR-PSU. SKB TR-14-05, Svensk Kärnbränslehantering AB.	Describes the current scientific understanding of the processes in the geosphere that have been identified in the FEP processing as potentially relevant for the long-term safety of the repository. Reasons are given in the process report as to why each process is handled a particular way in the safety assessment.
Initial state report	<b>Initial state report, 2014.</b> Initial state report for the safety assessment SR-PSU. SKB TR-14-02, Svensk Kärnbränslehantering AB.	Describes the conditions (state) prevailing in SFR directly after closure. The initial state is based on verified and documented properties of the repository and an assessment of the evolution during the period up to closure.
Input data report	<b>Input data report, 2014.</b> Input data report for the safety assessment SR-PSU. SKB TR-14-12, Svensk Kärnbränslehantering AB.	Describes the activities performed within the SR-PSU safety assessment and the input data used to perform these activities.
Model summary report	<b>Model summary report, 2014.</b> Model summary report for the safety assessment SR-PSU. SKB TR-14-11, Svensk Kärnbränslehantering AB.	Describes the computer codes used in the assessment.
Radionuclide transport report	<b>Radionuclide transport report, 2014.</b> Radionuclide transport and dose calculations for the safety assessment SR-PSU. SKB TR-14-09, Svensk Kärnbränslehantering AB.	Describes the radionuclide transport calculations carried out for the purpose of demonstrating fulfilment of the criterion regarding radiological risk.
Waste process report	<b>Waste process report, 2014.</b> Waste form and packaging process report for the safety assessment SR-PSU. SKB TR-14-03, Svensk Kärnbränslehantering AB.	Describes the current scientific understanding of the processes in the waste and its packaging that have been identified in the FEP processing as potentially relevant for the long-term safety of the repository. Reasons are given in the process report as to why each process is handled in a particular way in the safety assessment.



**Figure 2-5.** The report hierarchy of the safety assessment, including the Main report, Main references and additional references in the SR-PSU long-term safety assessment. The additional references either support the Main report or any of the Main References.

### Visualisation of assessment activities

An Assessment Model Flowchart (AMF) has been used to schematically represent assessment activities (models) and data passed between the assessment activities. The flowchart (Appendix G) shows how these are linked to each other. In addition to the models in the flowchart, additional calculations have been carried out such as pre-treatment of input data and post-processing of results.

## 2.6 Uncertainties

### 2.6.1 Regulatory requirements

The general advice to SSMFS 2008:21 states the following about uncertainties:

*Lack of knowledge and other uncertainties in the calculation presumptions (assumptions, models, data) are in this context denoted as **uncertainties**. These uncertainties can be classified as follows:*

- *scenario uncertainty: uncertainty with respect to external and internal conditions in terms of type, degree and time sequence*
- *system uncertainty: uncertainty as to the completeness of the description of the system of features, events and processes used in the analysis of both individual barrier performance and the performance of the repository as a whole*
- *model uncertainty: uncertainty in the calculation models used in the analysis*
- *parameter uncertainty: uncertainty in the parameter values (input data) used in the calculations*
- *spatial variation in the parameters used to describe the barrier performance of the rock (primarily with respect to hydraulic, mechanical and chemical conditions)*

*There are often no clear boundaries between the different types of uncertainties. The most important requirement is that the uncertainties should be described and handled in a consistent and structured manner.*

*The evaluation of uncertainties is an important part of the safety analysis. This means that uncertainties should be discussed and examined in depth when selecting calculation cases, calculation models and parameter values, as well as in the assessment of calculation results.*

## 2.6.2 Handling of uncertainties in the present analysis

It is important to be able to support all claims and assumptions in the assessment with scientific and technical arguments in order to lend credibility to the calculated results. Demonstrating understanding of the final repository system and its evolution is an important part of every safety assessment.

The initial state, together with the internal processes and external conditions, determines the future evolution of the repository and its environs. Uncertainties in the descriptions and understanding of these factors will always remain. Thus, all aspects of the future evolution of the repository system and thereby the safety assessment, are associated with uncertainty. How these uncertainties are managed is therefore of central importance in all safety assessments.

Confidence in the results of the calculation models is important, since the assessment of the radiological consequences of the repository is based on these results. The data underlying a safety assessment are always associated with deficiencies of various kinds. To put it simply, we are faced with the task of showing that the repository has been designed with sufficient margins to be safe in spite of the incomplete knowledge available. Confidence in the results depends on how methodically any uncertainties and deficiencies have been managed.

Deficiencies may be of a qualitative or a quantitative nature. Qualitative deficiencies concern, for example, questions regarding completeness: have all processes that affect the evolution of the repository been identified? Have all types of external processes been covered in the selection of scenarios? Other questions are quantitative: how well can the initial state be determined? How well can different processes be quantified, for example, concrete degradation or groundwater flow? These questions are particularly important for the analysis of radionuclide transport, which has a direct bearing on the evaluation of the repository's safety. Calculations of radionuclide transport handle quantities of input data that may be associated with uncertainties to a varying degree. Uncertainty management entails reporting the uncertainties and deficiencies associated with the data underlying the analysis and handling them in the execution of the analysis.

The handling of uncertainties in the present safety assessment related to the following: is described below:

- Completeness in identification of FEPs and scenario selection; addresses system uncertainty and scenario uncertainty.
- Conceptual uncertainty; addresses model and spatial variation uncertainty.
- Uncertainties in input data for calculations of radionuclide transport; addresses parameter uncertainty and spatial variability.

### ***Completeness in identification of FEPs and scenario selection***

It is not possible to guarantee that all important features, events and processes have been identified. It is instead necessary to determine whether the scope of the identification is sufficient for the needs of the safety assessment.

The work of identifying features, events and processes has been carried out systematically by going through SKB's and international lists of FEPs in order to ensure as far as possible that all relevant FEPs are considered. The efforts underlying the attempt to obtain an adequate identification and description of FEPs are described in Chapter 3.

It is not possible to guarantee a comprehensive choice of scenarios. In order to ensure, as far as possible, that all relevant scenarios have been identified, the safety functions identified for SFR have been used.

The factual review by experts in the field of safety assessment that has been conducted is also an important measure in striving for completeness.

### **Conceptual and model uncertainty**

The term “conceptual uncertainty” refers to those uncertainties resulting from an incomplete understanding of a process, as well as those uncertainties resulting from the fact that a mathematical model does not correctly describe a process (for which there may nevertheless be a good basic understanding).

The understanding of every process that has been identified comes from a large number of background reports, in particular from the different **Process reports**. The aim is to describe all processes as realistically as possible. Where realistic assumptions cannot be supported due to an imperfect understanding of the impact of the process, assumptions are made so that the consequences of processes unfavourable for repository functioning are overestimated and conversely so that the consequences of favourable processes are neglected. For example, in BLA, where the unconditioned low-level waste is disposed, the degradation and transformation of the waste is controlled by several complex processes and interactions. Instead of attempting to describe these processes in detail, the simplifying assumption is made that the waste does not contribute to retention of the radionuclides.

### **Uncertainties in input data for calculations of radionuclide transport**

In order to shed light on uncertainties in input data, probabilistic calculations have been carried out for hydrogeology, radionuclide transport and radiation exposure.

The data that are used specifically for calculations of radionuclide transport and dose have been taken from the **Data report** and Grolander (2013). A compilation of all data used in the assessment is presented in the **Input data report**.

Data selection conforms to the following principles:

- data selection is based primarily on the different analyses of the evolution of the repository and on the description of the initial state,
- selection of data should be justified either directly or via references to other critically reviewed work,
- if the same parameter is used in different analyses, the same parameter values should normally be used – if different data are used, the reason should be explained,
- the uncertainties in the data should always be discussed and quantified, if possible,
- data with quantified uncertainties should be used if possible for probabilistic calculations – if there are no quantified uncertainties, realistic data should be used and, where warranted, conservative estimates.

## **2.7 Documentation and quality assurance**

The present safety assessment has been conducted in accordance with the SKB quality management system.

The current document, its main references and the additional references published by SKB have been subjected to factual audit in accordance with SKB’s instructions. The acceptance criteria on which the audit is based are given in the audit plans prepared for the project. All parts of the audit are documented in a traceable manner in accordance with regulatory requirements.

In order to ensure that the safety analysis meets all requirements on long-term safety in regulations or decisions from regulatory authorities, the project has worked with four documents that define the requirements. These documents present the requirements in regulations and decisions, respectively. The project has worked with these lists in order to ensure that all requirements are complied with and to demonstrate this compliance to the regulatory authorities. The results are presented in Appendices A to D.

A large number of background reports have been produced within the safety assessment project. In the case of reports written by SKB, information on the author of each chapter or report is provided in the reports. Each report written within the project has been subjected to factual review by experts, and comments from these reviews are documented in the SKB document management system.

A number of steering documents have been prepared in line with the overall procedures for project management and safety audit. These control documents are summarised in Table 2-2.

**Table 2-2. Steering documents for SR-PSU.**

<b>Object</b>	<b>Language</b>
Project decision	Swedish
Project plan	Swedish
Quality plan for the SFR Extension project	Swedish
Document management plan SFR Extension project	Swedish
Instruction for qualification of "old" references	English
Quality assurance plan SR-PSU	English
Instructions for developing process descriptions in SR-PSU	English
Instructions for development and handling of the SKB FEP database – Version SR-PSU	English
SR-PSU model summary report instruction	English
Supplying data for the SR-PSU Data report	English
Instruction for use of preliminary data used in SR-PSU calculations/modelling	English
Instruction for model and data quality assurance for the SR-PSU project	English



## 3 Handling of FEPs

### 3.1 Introduction

Much of the methodology that is described in Chapter 2 has to do with handling of Features, Events and Processes (FEPs) at the different steps in the safety assessment. This chapter provides a more detailed description of how FEPs are handled throughout the assessment and of the different tools that are used to ensure a systematic and thorough treatment.

One of the main purposes of FEP handling is to create a catalogue of the FEPs that must be treated in the safety assessment.

### 3.2 Methodology for handling FEPs

#### 3.2.1 SKB's FEP database

An important and formal tool for ensuring that all relevant factors have been taken into account in the safety assessment is a database of features, events and processes (FEPs) that are of importance for long-term safety in a nuclear waste repository. Today SKB's FEP database covers both the Spent Fuel Repository and SFR.

The FEP database is based on the results of work with earlier safety assessments for the Spent Fuel Repository – SR-Site, SR-Can and SR 97 – which are described in the FEP reports for SR-Site (SKB 2010a) and SR-Can (SKB 2006a), in the Process Report for SR 97 (SKB 1999) and in the supporting documentation for the interaction matrices that have been constructed for a final repository of the KBS-3 type (Pers et al. 1999). Handling of FEPs was also documented in database format in previous studies for SFR. The approach that was adopted to FEP analysis and the structure of the FEP database, developed using interaction matrices, are documented for the two most recent safety assessments, SAFE and SAR-08 (SKB 2001a, 2008c). This database has been superseded and relevant information from it has been transferred into the consolidated database used in the current assessment. The work of updating SKB's FEP database so that it also covers SFR is described in the **FEP report**. The work has resulted in a version of SKB's FEP database that contains FEP catalogues for SR-Can, SR-Site and SR-PSU. The database also contains all project FEPs in the NEA's international FEP database, versions 1.2 (NEA 1999) and 2.1 (NEA 2006), including the classification and properties of these FEPs. Project FEPs are FEPs identified within different organisations' safety assessments projects. A more detailed description of SKB's FEP database can be found in the **FEP report**.

In a similar manner as was done for the spent fuel repository, processes of importance for the long-term safety of SFR were identified for different components of the system. The components of the system comprise the waste form, the waste packaging, the barriers in the waste vaults (1-2BMA, silo, etc), the geosphere and the biosphere. A set of variables has been defined for each component to describe the initial state of the component and how it changes over time.

#### 3.2.2 FEP catalogue for SR-PSU

Establishment of the FEP catalogue for SR-PSU was undertaken in several steps.

- The first step was taken by FEP coordinators, where the point of departure was the FEP catalogue from SR-Site, together with earlier FEP work for SFR. This work led to a preliminary version of the FEP catalogue for SR-PSU.
- After that, project FEPs in the NEA database (version 2.1) were mapped to FEPs in the preliminary FEP catalogue. This led to some minor updates in the FEP catalogue.
- Since many of the projects in the NEA database are concerned with high-level waste, a review was also made of FEPs from two projects for low- and intermediate-level waste: Olkiluoto L/ILW in Finland and Rokkasho 3 in Japan (both in unpublished preliminary versions). The review did not lead to any changes in the FEP catalogue.

The authors of the **Initial state report**, the **Biosphere synthesis report**, the **Climate report** and the **FHA report** (Future human actions), as well as the experts responsible for the documentation in the **Process reports**<sup>5</sup>, have since helped to establish the final FEP catalogue. The FEP categories included in the SR-PSU catalogue are listed below.

- Initial state FEPs.
- Internal processes in the system components waste form, waste packaging, barriers in the waste vaults (1–2BMA, silo, etc) and the geosphere.
- Variables for the system components waste form, waste packaging, barriers in the waste vaults (1–2BMA, silo, etc) and the geosphere.
- Biosphere FEPs.
- External FEPs.
- Methodology-related issues.

Furthermore, two site-specific factors – construction of a nearby repository (spent fuel repository) and the nearby nuclear power plant, including the Fenno-Skan cable (submarine high voltage direct current cable between Sweden and Finland) – have also been included in the SR-PSU catalogue.

The following text is a brief description of each category.

### ***Initial state FEPs***

This category describes the deviations from the initial state that follow from undetected mishaps, sabotage, failure to close the repository, etc. The deviations are used as a basis for the selection of scenarios described in Chapter 7. It should be pointed out that the intended initial state with tolerances, the reference initial state, is one of the cornerstones of the main scenario. The background to the reference initial state for the different system components is described in the **Initial state report**, in the Site Descriptive Model for the SFR area, SDM-PSU (SKB 2013e), and in the **Biosphere synthesis report** and is summarised in Chapter 4. The handling of initial state FEPs is further described in Section 3.3.

### ***Internal process FEPs***

These FEPs are processes that are relevant to the long-term safety of the repository for each of the system components waste form, waste packaging, barriers in the waste vaults (1–2BMA, silo, etc) and the geosphere. FEPs for the biosphere are handled as a separate category in the FEP catalogue, see below. Detailed documentation for all internal processes is provided in a number of **Process reports**, see further Section 3.4. The handling of all processes for waste form, packaging, barriers in the waste vaults, the geosphere and the biosphere is summarised in tables found in Appendix F. There are typically around 20 processes for each system component.

The results from the mapping of project FEPs in the NEA FEP database undertaken in preparation for SR-PSU were used to check that no relevant processes were missing in the set of processes for these system components. The check is documented in the form of FEP tables in the **FEP report**.

### ***Variables***

These FEPs are the variables (features) that are needed to describe the evolution of the system components waste form, waste packaging, barriers in the waste vaults (1–2BMA, silo, etc) and the geosphere over time. Biosphere FEPs are handled as a separate category in the FEP catalogue, see below.

Identification of variables has been done in cooperation between FEP coordinators and experts with good knowledge of the processes in the different system components with potential importance for long-term safety. The sets of variables were established in conjunction with the documentation of

---

<sup>5</sup> **Process reports** comprise the **Waste process report**, **Barrier process report** and **Geosphere process report**.

the processes. The reason for this is that it had to be ensured that they were suitable for describing all conceivable changes in the properties that may occur as a result of long-term processes. There are typically around ten variables for each system component.

Handling of how processes and variables affect each other is described in Section 3.2.3.

### ***Biosphere FEPs***

Biosphere FEPs are treated separately in the FEP catalogue for SR-PSU. In the same way as for other system components (see the above sections on processes and variables), there is a FEP record for each process and one for each variable. Beyond this, each subcomponent (definition see next paragraph) is represented by a record in the FEP catalogue.

For SR-PSU, the **Biosphere synthesis report** includes a description of the surface systems and the landscape development at Forsmark, and a description of, and results from, the radionuclide transport model for the biosphere, which all depend on FEPs. A systematic description of the biosphere FEPs and how they are handled is given in brief in the **Biosphere synthesis report**, whereas full definitions of the FEPs and a detailed description of the handling of the biosphere FEPs in the assessment are given in two supporting reports (SKB 2013c, 2014b). The first, general FEP report for the biosphere (SKB 2013c) contains definitions of subcomponents (e.g. regolith, water and primary producers) and variables (properties of the subcomponents) as well as general descriptions of the processes that are considered to be of importance for the alteration of the subcomponents over time, and for transport and accumulation of radionuclides between and within the subcomponents. The site-specific aspects of the processes are, however, described in the ecosystem reports developed for SR-Site (Andersson 2010, Aquilonius 2010, Löfgren 2010). The other FEP report for the biosphere (SKB 2015) describes how the biosphere FEPs identified as important for a geological repository in Forsmark are included in the safety assessment.

### ***External FEPs***

Project FEPs in the NEA database that were defined as external FEPs were divided into the same categories as those used in SR-Site (and SR-Can):

- climate-related issues,
- large-scale geological processes and effects,
- future human actions,
- others.

Climate-related issues and how they are handled is described in detail in the **Climate report**. The report includes seven climate-related FEPs. Each project FEP in the NEA database (version 2.1) that was mapped to these climate-related FEPs is documented in the FEP catalogue for SR-PSU. In SR-PSU, the handling of each project FEP in the NEA database has been reviewed and updated where necessary. The handling of climate-related FEPs is further described in Section 3.5.1.

Large-scale geological processes and how they are handled is described in the **Geosphere process report**. As for climate-related issues, it was checked that relevant aspects of project FEPs in the NEA database that have been mapped to FEPs for large-scale geological processes are covered by the descriptions in the **Geosphere process report**. The results of the check were documented in the FEP catalogue for SR-PSU.

Future human actions and how they are handled in the safety assessment are described in detail in the **FHA report**. The definitions of FHA FEPs that were used for SR-Site have been revised in SR-PSU, resulting in a finer subdivision with a total of 17 FHA FEPs. Each project FEP in the NEA database that was mapped to these FHA FEPs in SR-PSU, and their handling in SR-PSU, was documented in the FEP catalogue for SR-PSU. The handling of FHA FEPs is further described in Section 3.5.3.

### **Methodology-related issues**

A number of relevant issues relating to the basic assumptions and the methodology used for the assessment were identified in the NEA database. Most of them are of a very general nature, but are included in the FEP catalogue for the sake of comprehensiveness. As a result of the review of project FEPs in the NEA database, it was found that the FEP catalogue that was used for SR-Site can, as far as methodology-related issues are concerned, also be used for SR-PSU.

### **3.2.3 Couplings**

FEPs are coupled in multiple ways and on multiple levels. Couplings between processes and variables occur within a system component, and the system components influence each other in multiple ways. The following text is a description of different types of couplings and of the tools used to document and visualise them.

#### **Influence tables**

Within a system component, each process is influenced by one or more of the variables describing the state of the component. The process, in turn, influences one or more of the variables. These couplings within a system component are described by influence tables, one for each process, in the **Process reports**. A distinction is made between influences that exist in theory but are insignificant enough to be neglected in the safety assessment and influences that require thorough treatment. The handling of the latter category is explicitly mentioned as the handling of the process in question is established in the **Process reports**. An example of an influence table is shown in Table 3-2. The influence tables are fed back from the **Process reports** to the FEP catalogue.

Couplings between different system components are described in the process descriptions in the **Process reports** under the heading “Boundary conditions”, see further Section 3.4.1.

#### **Process diagrams (Influence diagrams)**

A process diagram is a graphic presentation that is generated on the basis of the influence tables. In the FEP database, a process diagram is generated for each system component. The diagram consists of a table in which the processes are depicted in the rows and the variables in the columns; see the example in Figure 3-1. The influences between processes and variables are shown in the table by arrows. Different colours of the arrows indicate whether the influence in question is handled in the assessment or not. Another way to graphically illustrate these couplings is in the form of an interaction matrix, see further below.

#### **Interaction matrices**

Interaction matrices offer an alternative to process diagrams to illustrate couplings between variables and processes. In the FEP database, there are interaction matrices for each system component in the repository, as well as for the geosphere and the biosphere. The elements of the principal diagonal in the matrix show the system component’s variables, whereas off-diagonal elements show the internal processes that act directly between two variables. An example of an interaction matrix is shown in Figure 3-2. It is not possible to display the whole matrix with all interacting processes at the same time. Therefore, a detail from one selected element is shown in the lower part of Figure 3-2. This more detailed information also shows which processes are handled in the assessment (red text) and which are neglected in the assessment (green text).

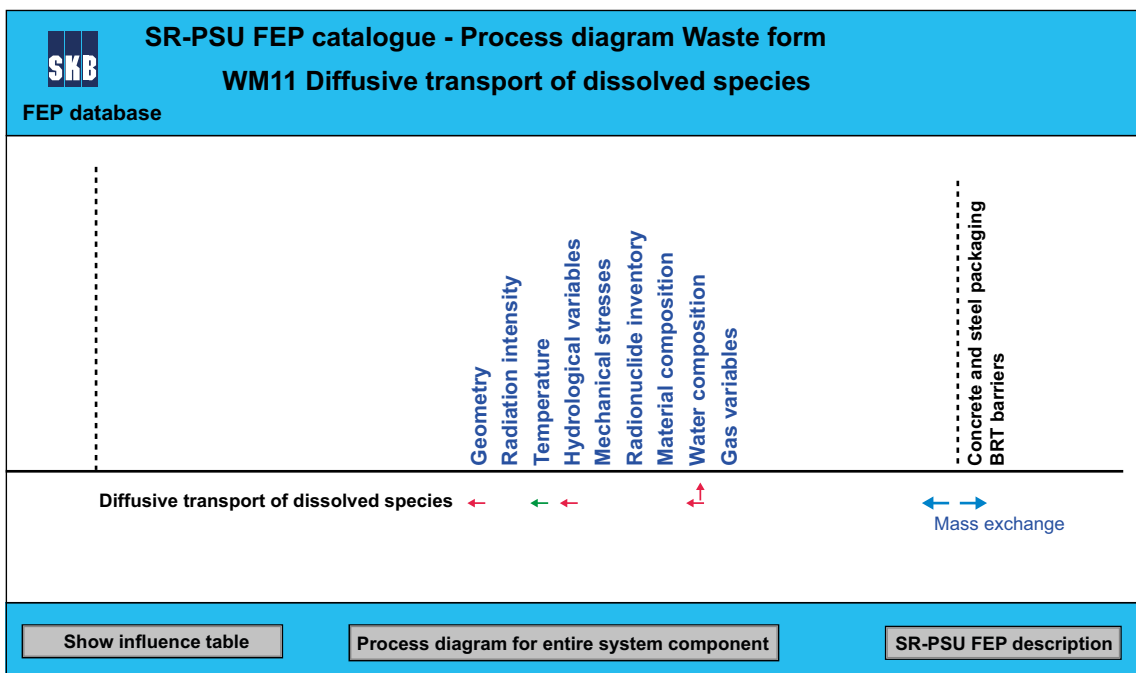
Since the biosphere consists of many subcomponents (e.g. regolith, water, primary producers), an interaction matrix with subcomponents as elements of the principal diagonal has been generated in addition to the aforementioned matrix to shed light on where in the biosphere particular processes are important for transport and accumulation of radionuclides. This matrix is also included in the FEP database and is described thoroughly in SKB (2013c).

### AMF, Model summary report and Input data report

When the evolution of the repository and its surroundings is evaluated, a number of coupled or interacting models/assessments are used. This set of models/assessments and dependencies between them are described with the aid of an Assessment Model Flowchart (AMF). The AMF for SR-PSU is further described in Section 3.4.3. The models in the AMF are described in the **Model summary report**. The **Input data report**, which is structured according to the AMF, presents all data used in the models.

### Handling of couplings

There are a large number of possible couplings in the system. The overwhelming majority of these couplings are not directly included in any of the models used to quantify the evolution of the system. Reasons for the neglect of couplings are given in, for example, the **Processes reports** where i) some processes – and thereby also associated couplings – have been assessed to have negligible influence, and ii) the inclusion or neglect of internal couplings is explained in the influence tables, see Section 3.4.1.



**Figure 3-1.** Part of the process diagram for the waste form showing the influences between the process Diffusive transport of dissolved species and the waste form variables. An arrow directed upwards indicates influence by the process on the variable, whereas an arrow directed to the left indicates an influence by the variable on the process. Red arrows indicate that the influence in question is handled in the assessment, whereas green arrows indicate that the influence exists but is not assessed.

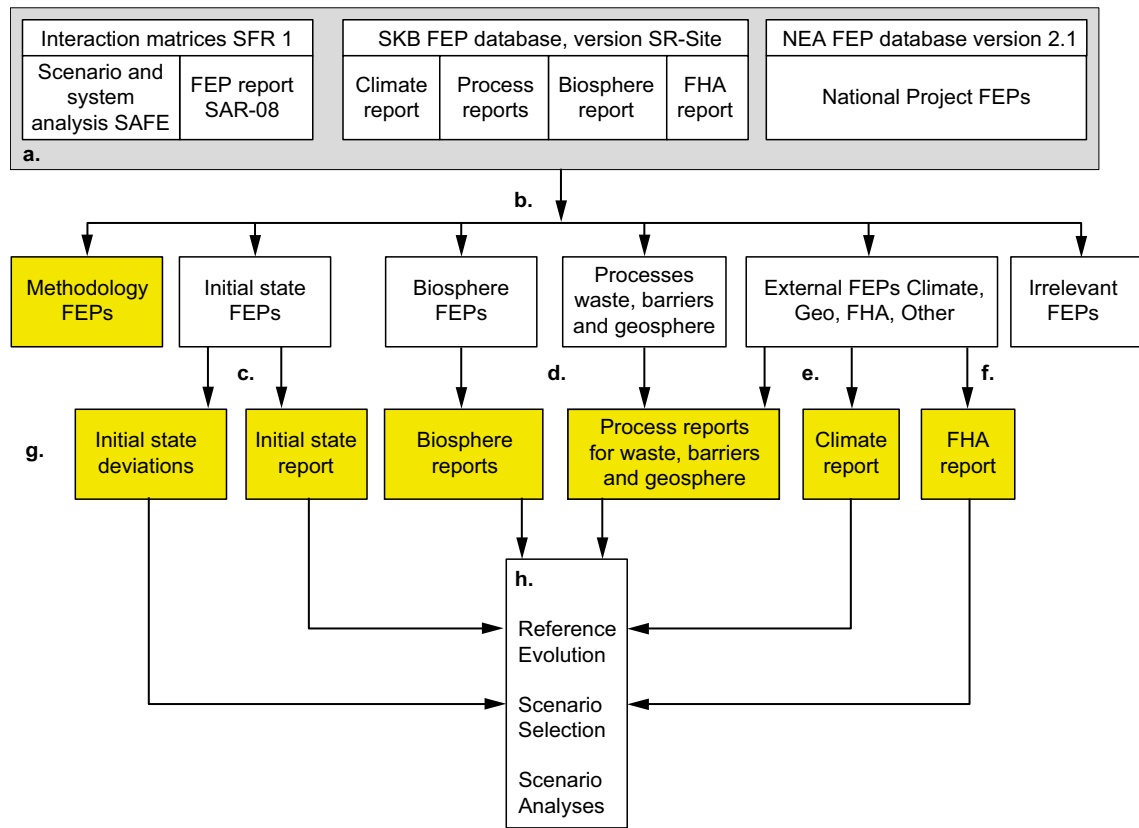
01.01	01.02	01.03	01.04	01.05	01.06	01.07	01.08	01.09
Geometry	Radiation	Radiation	Heat transport	Heat transport	Transport of	Radiolytic	Radiolytic	Radiolytic
Phase	Transport of	Water	Phase	Phase	Transport of	Dissolution,	Water	Water
		Heat transport	Water uptake	Fracturing		Water	Phase	Heat transport
02.01	02.02	02.03	02.04	02.05	02.06	02.07	02.08	02.09
Dissolution,	Radiation intensity	Radiation	Heat transport	Heat transport		Radiolytic	Radiolytic	Radiolytic
Degradation of	Radiation	Water	Water uptake	Dissolution,		Dissolution,	Water	Water
Water		Heat transport		Water		Degradation of	Dissolution,	Heat transport
03.01	03.02	03.03	03.04	03.05	03.06	03.07	03.08	03.09
Phase	Sorption/uptake	Temperature	Heat transport	Heat transport	Transport of	Radiolytic	Radiolytic	Radiolytic
Fracturing	Transport of		Phase	Phase	Transport of	Sorption/uptake	Water	Water
Colloid		Water	Water uptake	Fracturing		Dissolution,	Phase	Heat transport
04.01	04.02	04.03	04.04	04.05	04.06	04.07	04.08	04.09
Phase	Radiation	Radiation	Hydrological variables	Heat transport	Transport of	Radiolytic	Radiolytic	Radiolytic
Fracturing	Sorption/uptake	Water		Phase	Transport of	Sorption/uptake	Water	Water
Colloid	Transport of	Heat transport	Heat transport	Fracturing		Dissolution,	Phase	Heat transport
05.01	05.02	05.03	05.04	05.05	05.06	05.07	05.08	05.09
Fracturing		Heat transport	Heat transport	Mechanical stresses		Dissolution,	Dissolution,	Heat transport
Dissolution,		Dissolution,		Heat transport				Dissolution,
06.01	06.02	06.03	06.04	06.05	06.06	06.07	06.08	06.09
Colloid	Radioactive	Radioactive		Dissolution,	Radionuclide inventory	Radiolytic	Radioactive	Radioactive
Dissolution,	Radiation	Radiation			Radioactive	Dissolution,	Radiolytic	Radiolytic
	Transport of	Water					Water	Water
07.01	07.02	07.03	07.04	07.05	07.06	07.07	07.08	07.09
Phase	Radiation	Radiation	Heat transport	Heat transport	Transport of	Material composition	Radiolytic	Radiolytic
Fracturing	Sorption/uptake	Heat transport	Phase	Phase	Transport of	Radiolytic	Phase	Heat transport
Colloid	Transport of	Phase	Water uptake	Fracturing			Sorption/uptake	Water uptake
08.01	08.02	08.03	08.04	08.05	08.06	08.07	08.08	08.09
Phase	Sorption/uptake	Water	Heat transport	Heat transport	Transport of	Radiolytic	Water composition	Radiolytic
Colloid	Transport of	Heat transport	Phase	Phase	Transport of	Sorption/uptake	Radiolytic	Water
Dissolution,		Phase	Water uptake	Dissolution,		Dissolution,		Heat transport
09.01	09.02	09.03	09.04	09.05	09.06	09.07	09.08	09.09
Colloid	Transport of	Water	Heat transport	Heat transport	Transport of	Dissolution,	Water	Gas variables
Dissolution,		Heat transport	Water uptake	Dissolution,	Transport of	Microbial	Colloid	
Microbial		Water uptake	Water transport	Gas formation			Dissolution,	Water

<b>Matrix element Number</b>
01.03
<b>Interactions handled</b>
Phase changes/freezing
Water uptake and transport during unsaturated conditions
<b>Interactions neglected</b>
Radiation attenuation/heat generation
Water radiolysis
Heat transport
Water transport under saturated conditions
Dissolution, precipitation and recrystallisation
Water uptake/swelling
Microbial processes

Figure 3-2. Interaction matrix for the waste form. The elements of the principal diagonal in the matrix show the system component's variables, whereas off-diagonal elements show the internal processes that act directly between two variables. The lower figure shows details for element 01.03 showing processes that act between the variable Geometry and the variable Temperature. Processes in red are handled in the analysis, whereas processes in green are neglected.

### 3.2.4 Summary of the methodology for handling FEPs

The handling of FEPs in SR-PSU is summarised in Figure 3-3.



- a. The point of departure for the FEP handling in SR-PSU is interaction matrices from previous safety assessments for SFR (including associated reports), FEPs in the SR-Site version of SKB's FEP database (including the FEP catalogue from SR-Site and associated SR-Site reports) and project FEPs in the NEA's FEP database, version 2.1.
- b. FEPs are divided into three main categories: i) initial state, ii) internal processes (including biosphere) and iii) external FEPs. FEPs are also categorised as irrelevant or as generally methodology related.
- c. Initial state FEPs can either i) be included in the description of the initial state in SR-PSU, or ii) be categorised as deviations from the initial state to be further handled in scenario selection.
- d. Process FEPs are documented in the **Process reports** for SR-PSU. Biosphere FEPs and the handling of these in the assessment are briefly described in the **Biosphere synthesis report** whereas full definitions of the biosphere FEPs are given in the general FEP report for the biosphere (SKB 2013c), and the handling of each process is described in SKB (2014b).
- e. The handling of external FEPs concerning climate and long-term climate change is documented in the **Climate report**. The few external large-scale geosphere FEPs are dealt with in the **Geosphere process report**.
- f. The handling of external FEPs concerning future human actions (FHAs) is described in the **FHA report**.
- g. The FEPs handled in the yellow boxes comprise the FEP catalogue for SR-PSU.
- h. The reference initial state, all long-term processes and an external evolution for the reference case are used to define a reference evolution for the repository system. This evolution is an important foundation stone in an extensive main scenario. A set of additional scenarios addresses e.g. deviations from the reference initial state and the reference external evolution, as well as situations involving FHAs.

**Figure 3-3.** Handling of FEPs in SR-PSU.

### 3.3 Initial state FEPs

Initial state FEPs in the SR-PSU FEP catalogue are either related to an initial state in conformity to the specification given for the design or to deviations from the reference design. The former of these are handled in the category of variables in the SR-PSU FEP catalogue.

The initial state FEPs that are related to deviations from the expected initial state are compiled in Table 3-1. One such FEP of a more general character is related to severe mishaps not expected to occur during the operational phase, like fires, explosions, sabotage and severe flooding or other events occurring prior to closure. Such events are excluded from the scenario selection. The reasons for this are i) the probabilities for such events are low and ii) if they occur, they shall be reported to SSM, their consequences assessed and correcting or mitigating actions will be implemented accordingly.

Another FEP in the SR-PSU FEP catalogue refers to the effect of phased operations, i.e. for example 1BLA will be filled with waste in about five years from now. This phased operation is planned and closure will be performed at the same time for the whole repository. Therefore, this is not treated as a deviation from the initial state.

Abandoned, not completely sealed repository is another FEP. This issue is propagated to the scenario selection in Chapter 7.

One FEP concerns design deviations due to undetected mishaps during manufacturing, transportation, deposition and repository operations etc. Measures to avoid or mitigate such deviations during excavation, manufacturing, handling, deposition etc are described in the **Initial state report**. To the extent that such mishaps may still occur, these issues are addressed in the analyses through the uncertainty ranges used. A summary of the initial state FEPs in the SR-PSU FEP catalogue and how they are handled in SR-PSU is given in Table 3-1.

**Table 3-1. Initial state FEPs related to deviations from the expected initial state and how they are handled in SR-PSU.**

Initial state FEP	Handling in SR-PSU
ISGen01 Major mishaps/accidents/sabotage	Excluded. The probabilities for such events are low. If they occur, this will be known prior to repository sealing, so mitigation measures and assessments of possible effects on long-term safety can be based on the specific real event.
ISGen02 Effects of phased operation	Excluded from explicit consideration, as its implications are included in the definition of the initial state.
ISGen03 Incomplete closure	Considered in selection of scenarios, see Chapter 7.
ISGen04 Monitoring activities	Excluded. Monitoring activities that could disturb the repository safety function will not be accepted.
ISGen05 Design deviations – Mishaps	Covered by the data uncertainty ranges that are used.

### 3.4 Handling of internal processes

An in-depth understanding and handling of the processes that take place over time in the repository system is fundamental for the safety assessment. The primary sources of information for this are the results of decades of research and development work carried out by SKB and other organisations. In a broader perspective, these results are, in turn, based on knowledge that has emerged over an even longer period of scientific and technical development. The research and development work has led to the identification and understanding of a number of processes occurring in the repository and in the associated natural systems that are relevant to long-term safety. For the purposes of the safety assessment, the relevant knowledge regarding internal processes in the repository, the geosphere and the biosphere is compiled in the **Process reports** and the **Biosphere synthesis report**. For each process, there is also an instruction on how it is to be handled in the safety assessment. This chapter describes how processes are documented in the process reports in SR-PSU and the principles of how they are



handled in the safety assessment, taking into account relevant uncertainties. The format for documenting processes in the process reports for SR-PSU is described in Section 3.4.1. An overview of the handling of all processes in SR-PSU is provided in Section 3.4.2 and Appendix F, based on the material in the **Process reports** and the **Biosphere synthesis report**. The AMF (Assessment Model Flowchart) for SR-PSU, which shows models/assessments and couplings between them, is described in Section 3.4.3.

### 3.4.1 Format for the process documentation

There are **Process reports** for SR-PSU to document all internal processes that have been found to be relevant to long-term safety in SFR in the waste form, the waste packaging, the barriers in the waste vaults (1–2BMA, silo, etc) and the geosphere. The processes in the biosphere are documented in the **Biosphere synthesis report**. The documentation of the external climate processes is described in Section 3.5.1. The process descriptions for the biosphere do not follow the format used in the process reports for other system components, but are on a more general level. The main reason for this is that the biosphere consists of many different subcomponents with numerous interactions between them. More extensive process descriptions for the biosphere are presented in separate reports produced for SR-Site (e.g. Löfgren 2010, Andersson 2010, Aquilonius 2010, Bosson et al. 2010). For SR-PSU, as a complement to the **Biosphere synthesis report**, all biosphere FEPs have been documented in a separate report with a clear description of how they are handled in the safety assessment and with reference to underlying biosphere reports (SKB 2015).

The purpose of the **Process reports** is to document scientific knowledge regarding the processes to the extent required to deal with them in an adequate manner in the SR-PSU safety assessment. For this reason, the documentation is not completely exhaustive or detailed from a scientific perspective, since this is neither necessary for the purposes of the safety assessment nor possible within the framework of an assessment. Another purpose is to establish a strategy for handling each process in the safety assessment and demonstrate how uncertainties are taken into consideration, given the chosen handling method. In general, all arguments, along with background data relating to decisions and supporting references, are given in the process description under relevant headings. Furthermore, the **Process reports** provide documentation on which expert (or experts) compiled the fundamental information for each process and which expert or experts were involved in the decision on how to handle it in the safety assessment. All of these experts and the reviewers are included in the SR-PSU list of experts, which is required according to the quality assurance plan for the SR-PSU safety assessment, see Table 2-2. All identified processes are documented according to a template that is presented below.

#### Overview/general description

A general description of the knowledge concerning the process is given under this heading. The section may also contain text that directly supports the chosen handling in SR-PSU.

#### Dependencies between process and variables

For each process an influence table is presented under this heading, with documentation on how the process is affected by the reported set of physical variables (see Section 3.2.2) and how the process influences the variables. Moreover, the table shows how each type of influence is handled in SR-PSU. In all cases where an influence exists but is not handled in the assessment, an explanation for this is given in the table and/or in the process description. An example of an influence table is shown in Table 3-2.

**Table 3-2. Influence table for the process “diffusive transport of dissolved species” in the waste form.**

Variable	Variable influence on process		Process influence on variable	
	Influence present?	Handling of influence	Influence present?	Handling of influence
Geometry	Yes. Diffusion is proportional to waste form dimensions and is significantly affected by heterogeneities and pore geometry.	Included in the transport modelling.	No.	Not relevant.
Radiation intensity	No.	Not relevant.	No.	Not relevant.
Temperature	Yes. Affects diffusivity. At high temperature gradients even Soret effects may occur.	Not considered due to the largely isothermal conditions in SFR	No.	Not relevant.
Hydrological variables	Yes. The aggregation state of water directly influences the extent of diffusion.	Changes in effective diffusivity due to water freezing will be included in the transport modelling.	No.	Not relevant.
Mechanical stresses	No. Indirectly mechanical stresses affect porosity and pore geometry, and therefore indirectly the effective diffusivity of species.	Not relevant.	No.	Not relevant.
Radionuclide inventory	No. Indirectly, the diffusion of radionuclides is directly influenced by the dissolved concentration which, in turn, is affected by the inventory.	Not relevant.	No. Indirectly, diffusion of dissolved radionuclides promotes further dissolution which affects the evolution of the inventory.	Not relevant.
Material composition	No. Indirectly, material composition determines the porosity and the pore geometry in the stabilised waste forms.	Not relevant.	No.	Not relevant.
Water composition	Yes. A major control of diffusion in the waste forms.	Included in the transport models.	Yes. Affects the water composition through the movement of dissolved chemical species, colloids, particles and dissolved gases in stagnant systems.	Included in the transport models.
Gas variables	No. Indirectly, diffusion is directly influenced by the dissolved concentration which, in turn, is affected by the gas variables within the waste form.	Not relevant.	No. Indirectly, diffusion of dissolved gases will influence their aqueous concentration which, in turn, affects the gas composition.	Not relevant.

### Boundary conditions

Here the boundary conditions for each process are dealt with. They represent the boundaries of the relevant system components. In the case of waste packaging, for example, the boundaries are the interfaces between waste and waste form packaging and between waste packaging and barriers in the waste vaults (1–2BMA, silo, etc). The processes for which the boundary conditions must be described are in general related to transport of material or energy across the interfaces. Internal boundary conditions, for example the boundary between fractures and rock matrix, are also described here. The discussion of boundary conditions for chemical processes that take place in a component pertains to the boundary conditions for the relevant transport processes that take place in the waste packaging, i.e. advection and diffusion.

### **Model studies/experimental studies**

Here, model studies and experimental studies concerning the process or the proposed handling are summarised. Reference can be made here to SKB's site investigations, site descriptive models and safety assessments (e.g. SAFE, SAR-08, SR-Site), but also studies outside of SKB and in other scientific fields.

### **Natural analogues/observations from nature**

If relevant, natural analogues and/or observations from nature concerning the process are documented under this heading.

### **Time perspective**

The timescale or timescales during which the process takes place are documented here, if such timescales can be defined. The timescales of interest for the safety assessment are described in Section 2.3.1.

### **Handling in the safety assessment SR-PSU**

Handling of the process in the safety assessment SR-PSU is described under this heading. For the most part, the process can either be:

- neglected based on the information under the previous headings,
- neglected providing a special condition is fulfilled,
- included in a simplified manner, which is described,
- included by modelling.

With the help of the information under this subheading, all processes are tied to a handling method, and suitable models are developed as needed, see further in Section 3.4.2.

### **Handling of uncertainties in SR-PSU**

Given the chosen handling method for each process in the SR-PSU safety assessment, the handling of different types of uncertainties associated with the process is summarised here.

*Uncertainties in mechanistic understanding:* Uncertainties in the general understanding of the process are dealt with based on available documentation and for the purpose of answering the question: Are the fundamental scientific mechanisms that control the process included, and are they understood to the degree required for the chosen handling method? Alternative models are sometimes used to illustrate this type of uncertainty.

*Model simplification uncertainties:* The quantitative representation of a process usually contains simplifications. This can be a crucial source of uncertainty in the description of the evolution of the system. For a specific conceptual model, alternative models or alternative approaches to simplification are sometimes used to illustrate this type of uncertainty.

*Input data and data uncertainties:* The set of input data that is required to quantify the process for the proposed handling is documented. The further handling of important input data and uncertainties in input data are described in the **Data report**, to which reference is made if relevant.

### **Adequacy of references that support to the handling in SR-PSU**

The adequacy of the references in a quality assurance perspective is presented under this heading. The account is limited to those references that provide direct support for the chosen handling method. The references are evaluated in the issue-specific review in the **Process reports**, along with the arguments and reasons for the chosen handling method described in the preceding subsections in the process description.

### 3.4.2 Summary of handling of internal processes

In order to summarise the process handling in the safety assessment, a set of tables has been prepared for each system component to show the handling of each process, based on the handling documented in the **Process reports** and the report treating the handling of each biosphere process (SKB 2015). In the tables, the process is referred either to a model with whose help it is quantified, or it is provided with a short description in words of how it is to be handled. These tables for the waste form, the waste packaging, the barriers in waste vaults (1–2BMA, silo, etc), the geosphere and the biosphere are presented in Appendix F.

### 3.4.3 Assessment Model Flowchart, AMF

To provide an overview of the various assessment activities and models used in the evaluation of repository evolution and radionuclide transport, as well as the connection between them in the form of data flows, a model and data flowchart (AMF) has been created, see Appendix G. Each coupling between the assessment activities has been given a number that points to a chapter in the **Input data report** where data are described. The codes that are used are described in the **Model summary report**. A table including a summary of the assessment activities, a statement of which processes are included in each assessment activity, where the assessment activity is documented, and which couplings deliver input data to each assessment activity is provided in Appendix F.

## 3.5 Handling of external conditions

External conditions at the repository site will change considerably during the period covered by the safety assessment. External conditions and the way in which they change with time are described using external FEPs that comprise one of the main categories in the FEP catalogue for SR-PSU, see Section 3.2.2 and the **FEP report**. External FEPs are divided into the following subgroups:

1. Climate-related issues.
2. Large-scale geological processes and effects.
3. Future human actions.
4. Others (only meteorite impacts have been identified in this group).

Climate change and climate-related changes, such as the ongoing shoreline displacement, are the most important external factors that affect the repository in a time perspective that ranges from tens of years to a hundred thousand years. Most long-term processes that are relevant to safety and that occur in the biosphere and the geosphere are affected by climate change and climate-related changes. The safety assessment must therefore treat the possible influence of all plausible climate-related changes on the safety of the repository. Climate-related issues are further dealt with in Section 3.5.1.

The large-scale geological processes that are included in the category “external FEPs” are tectonic uplift and crustal movements. These processes are dealt with in Section 3.5.2.

Another group of external FEPs that can affect the repository is future human actions (FHAs). These FHA FEPs include potential actions that take place on or near the repository site and that can affect the function of the repository either directly or indirectly. Future human actions are further treated in Section 3.5.3.

The subgroup “other external FEPs” in the FEP catalogue contains only the FEP record “meteorite impacts”. Meteorite impacts have been excluded from further analysis, since there is very little likelihood that a meteorite big enough to damage the repository will actually impact the Earth. The probability that the impact will occur on the repository site is very low. Moreover, such an impact would cause great damage to the local and regional biosphere, humans included (Collins et al. 2005). These direct effects of a meteorite impact are judged to be far more serious than any possible radiological consequences.

### 3.5.1 Climate-related issues

The Earth's climate system consists of the following four main parts: atmosphere, hydrosphere, cryosphere and lithosphere. The biosphere interacts with the climate system by influencing energy and water balances between the atmosphere and lithosphere. The biogeochemical element cycles, such as the carbon cycle, interact with the climate system by influencing the composition of the atmosphere, among other things. Furthermore, a large number of atmospheric chemical processes also influence the composition of the atmosphere. The principal external factors that affect the climate system are the sun, volcanic eruptions, anthropogenic releases of gases and aerosols and other human impacts.

The future evolution of the Earth's climate cannot be predicted exactly. This is due to insufficient knowledge of the components of the climate system and interactions between them, but also to the fact that the system is chaotic. In order to handle the uncertainty in the future climate evolution during the coming 100,000 years, a span of future climate evolutions has been defined. The span is represented in the SR-PSU safety assessment by four different climate cases (see the **Climate report** Section 1.2). These cases have been defined on the basis of knowledge of the climate-related processes that are of importance for the long-term safety of the repository and present-day knowledge of the past and potential future climate evolution.

#### ***Climate-related processes of importance for the function and long-term safety of the repository***

Global climate variations can entail growth and degradation of permafrost and ice sheets as well as variations in sea level, which affect conditions both at and beneath the ground surface. The climate-related processes that are of importance for the repository for low- and intermediate-level nuclear waste in Forsmark, and which are therefore analysed in the SR-PSU safety assessment (see **Climate report** Section 1.2), are the following.

- Permafrost evolution; a sufficient reduction of the temperature in the bedrock will cause freezing of concrete and bentonite barriers in the SFR.
- Shoreline displacement; affecting well drilling in the vicinity of the repository.
- Inland ice sheet; growth of an inland ice sheet above the repository causes high hydrostatic pressures and pressure gradients, which affect repository structures.
- Denudation of the ground surface; as a result of the glacial erosion that takes place when the ice sheet retreats from the area, the radioactive waste is closer to the ground surface.
- Long periods of groundwater recharge due to precipitation in conjunction with global warming; freshening of the groundwater takes place during long periods when the ground surface above the repository lies above sea level.

#### ***Future climate evolution***

It is highly likely that the current interglacial (the Holocene) will be significantly longer than previous interglacials as a result of human emissions of carbon dioxide to the atmosphere, along with future variations in insolation (e.g. Berger and Loutre 2002). During previous interglacials – such as the Eemian, which started about 130,000 years ago – the carbon dioxide concentration in the atmosphere reached a peak of about 300 ppmv, after which it declined. This stands in stark contrast to the present-day situation, where the carbon dioxide concentration has increased from about 280 ppmv to nearly 400 ppmv in 160 years and is expected to increase further to a peak determined by human activities (e.g. Solomon et al. 2011, IPCC 2013). The carbon dioxide concentration is then expected to decline very slowly due to the processes that remove carbon dioxide from the atmosphere. Based on the current state of knowledge, Archer et al. (2009), for example, draw the conclusion that the effects of carbon dioxide emissions on the Earth's climate will be apparent for tens of thousands, or even hundreds of thousands, of years in the future.

### **Handling uncertainty in the long-term trend**

The timing and scope of future climate change is uncertain in the time perspective that is dealt with in the safety assessment, see the **Climate report**. On a timescale of 100,000 years, it is not possible to predict a specific future climate evolution with the reliability that is needed for the assessment of the repository's long-term safety. However, the *range* within which the climate in Sweden might vary during the next 100,000 years can be predicted with sufficient reliability. Instead of focusing on a most likely future climate evolution, the strategy in the safety assessment work is to identify, describe and analyse this range of variation, including its extremes. Within these limits it is possible to define a number of characteristic climate domains (see Section 6.2 and the **Climate report**). The climate domains that are of relevance for Forsmark are:

- a temperate climate domain,
- a periglacial climate domain,
- a glacial climate domain.

The purpose of identifying these climate domains is to create a framework for assessing climate-related processes of importance for the safety of the repository. The extent of the climate domains varies with both time and location. The duration of each climate domain depends on both global climate changes and more regional and local factors.

The overall strategy for handling climate and climate-related processes in safety assessments, i.e. to define a number of possible future climate evolutions (climate cases) that cover the uncertainty in the future climate evolution, is the same in SR-PSU as in previous recent safety assessments performed by SKB (e.g. SR-Site and SAR 08). However, due to differences in the nature of the waste (radioactivity level and half lives), which determines the time period to be covered by the safety assessment, as well as differences in repository concept (barrier material and repository depth), the span represented by the climate cases differs between different safety assessments (see further Näslund et al. 2013). The radioactivity of the waste in SFR declines to low levels within the first ten thousand years or so after closure, warranting a total assessment period of 100,000 years. This can be compared with the safety assessment for a repository for spent nuclear fuel (SR-Site), where the assessment period is a million years. The shorter assessment period for SFR, plus a shallower repository depth (about 60–140 m for SFR compared with 450–470 m for the Spent Fuel Repository), requires a greater focus on the evolution of the climate during the next few tens of thousands of years. The earliest possible onset of shallow permafrost growth and freezing of the barrier structures in SFR is then of great importance. This question was not relevant in the SR-Site safety assessment. What was instead relevant was the question of whether freezing in conjunction with permafrost can reach repository depth during the assessment period of a million years (SKB 2011).

In earlier safety assessments for low- and intermediate-level waste (SAR-08) and for spent nuclear fuel (SR-Can, SR-Site), a reconstruction of the last glacial cycle was used, along with a span of other climate cases, to assess the long-term safety of the repository. In the present safety assessment, the methodology for assessing safety for SFR has been refined. Given the shallow repository depth and the properties of the barriers, the assessment has focused on determining the potential time of onset of the first period with permafrost in the Forsmark area. Present-day knowledge of relevance to this question has therefore been given more weight in the definition of the climate cases analysed in SR-PSU. The current state of knowledge suggests that due to human activities, in combination with small variations in future insolation, the evolution of the global climate during the coming hundred thousand years will not resemble the last glacial cycle (**Climate report**). The climate case based on a reconstruction of the last glacial cycle is therefore given less weight in the SR-PSU safety assessment. In summary, the difference between the strategy for defining climate cases of relevance to the safety assessment between the current SR-PSU and the previous safety assessment for the Spent Fuel Repository (SR-Site) is primarily warranted by the following considerations.

- The time period for the safety assessment is 100,000 years for low- and intermediate-level waste, to be compared with 1,000,000 (1 million) years for spent nuclear fuel. This means that the present safety assessment is handling a *specific* hundred-thousand-year period, during which the effects of human activities are expected to be great. By contrast, safety assessments for spent nuclear fuel repositories handle a *typical* hundred-thousand-year period representing natural climate variations recorded in geological archives during the past 700,000 years.

- Our scientific understanding of the effects of human activities on the long-term climate evolution has improved during the past few decades. The coming 100,000 years are expected to be characterised by a prolonged interglacial lasting 50,000 – or even 100,000 – years due to the high concentrations of carbon dioxide in the atmosphere, in combination with small variations in insolation.

The handling of the climate evolution is further elaborated on in Chapter 7 in conjunction with the selection of scenarios. The handling of climate-related FEPs in SR-PSU is summarised in Table 3-3.

### Documentation

The climate-related states and processes that are relevant to the long-term safety of a repository for low- and intermediate-level waste in Forsmark are described in the **Climate report**, one of the main references for the SR-PSU safety assessment. The purpose of the **Climate report** is to document the scientific state of knowledge regarding the climate-related processes that are relevant to the long-term safety of a repository for low- and intermediate-level waste as well as the scientific state of knowledge regarding the past and future evolution of the global and regional climates to the extent required to treat them in a suitable manner in the safety assessment. The **Climate report** also compiles results from the simulations of permafrost, shoreline displacement and ice sheets that have been used to construct the different climate evolutions that are then used as a basis for further analyses. The **Climate report** also contains a description of denudation processes, i.e. weathering and erosion, that wear down the ground surface. The report contains four chapters:

1. Introduction.
2. Climate-related processes.
3. Past and future climate evolution.
4. Climate cases for the SR-PSU safety assessment.

The introductory chapter provides a more detailed description of the approach that is employed to handle the climate in the safety assessment work. Here, climate-related processes that are of importance for the long-term safety of a repository for low- and intermediate-level waste are identified. These processes are described in Chapter 2 to the extent required to treat them appropriately in the safety assessment. Chapter 2 also describes the simulations that have been done to reconstruct these parameters for the last glacial cycle. Chapter 3 describes the scientific state of knowledge regarding the global and regional climate evolution during the last glacial cycle and for the next 100,000 years. Chapter 4 describes the method used to define the future climate evolutions (climate cases) that are analysed in the SR-PSU safety assessment. Furthermore, each of these climate cases is described in terms of the future evolution of the climate and climate-related processes in Forsmark during the next 100,000 years.

**Table 3-3. Climate-related FEPs in SR-PSU and handling in the assessment.**

FEP number	Name	Included in scenario
Cli02	Climate forcing	All scenarios
Cli03	Climate evolution	All scenarios
Cli05	Permafrost development	Accelerated concrete degradation
Cli06	Ice-sheet dynamics and hydrology	Glaciation and post-glacial conditions (climate evolution based on repetition of Weichselian)
Cli08	Glacial isostatic adjustment	All scenarios
Cli09	Shore-level changes	Intrusion wells Wells downstream of the repository
Cli10	Denudation	All scenarios

The contents of the **Climate report** have been checked against FEP databases created in the course of other organisations' safety assessments (project FEPs in the NEA database version 2.1), see the **FEP report**. The **Climate report** follows, where possible, the template for documentation of processes considered to be internal to the repository system, see Section 3.4.1. However, a number of complex climate-related issues are treated in an integrated fashion rather than through an account of single processes. Such issues are: i) evolution of permafrost, ii) isostatic changes and shoreline displacement, iii) the dynamics of ice sheets and iv) denudation. Each climate-related issue includes a set of processes which together result in the description of a system or a feature. For example, "the dynamics of ice sheets" results from several thermal, hydrological and mechanical processes, but can – in view of the interaction between the ice and the bedrock – be regarded as a unit.

### 3.5.2 Large-scale geological processes and effects

The large-scale geological processes that are included in the category "external FEPs" are "Mechanical evolution" and "Earthquakes" including uplift (vertical deformation) due to tectonic activity and crustal movements (i.e. horizontal deformation).

The large-scale mechanical evolution of the shield as well as earthquakes are described in the SR-Site Geosphere process report (SKB 2010b, Sections 4.1.2 and 4.1.3 respectively). These descriptions apply also for SFR. The causes of mechanical processes in the geosphere may be of quite different origin, from natural large-scale processes, such as tectonic plate movements, to fast small-scale events, such as rock fallout at a tunnel periphery. Rock mechanical processes take place in the bedrock due to changes in load or due to changes in material properties. Irrespective of the nature of the cause, the response in the rock mass will consist of some displacement and maybe fracturing. Hence large-scale geological processes are indirectly inferred in the descriptions of intrinsic processes and interactions in the **Geosphere process report**.

### 3.5.3 Future human actions

Forecasting human actions that may influence conditions on a repository site is speculative, at best, since the evolution of man and society is virtually impossible to predict. The safety assessment only includes actions with a potential impact on the function of the repository system that are performed without knowledge of the repository and/or its function and purpose, i.e. inadvertent actions. An example of a future human action at the repository site with a direct impact on the function of the repository is drilling to repository depth. An example of a future human action at or in the vicinity of the repository site with a potential indirect impact on the repository is mining in the vicinity of the repository that could affect the groundwater so that the hydrological boundary conditions for the repository are altered.

FHA FEPs do not include the behaviour and habits of a future local or regional population that affect the biosphere but have no effect on hydrogeology or hydrogeochemistry. An example of such actions is how arable land is farmed. This can have a great influence on the exposure pathways in the biosphere, but is negligible in terms of the function and safety of the repository and is hence not a FHA FEP.

As mentioned in Section 3.2.2, the FEPs that are related to FHAs in SR-Site have been revised. The methodology has also been developed so that the technical aspects of FHA FEPs are more closely tied to the safety functions of the repository system and other factors relevant from the perspective of long-term safety. A total of 17 FHA FEPs have been identified. These FEPs have been checked against the safety functions and other factors that are relevant to safety. When identified as important to consider they have been included in one of the three FHA scenarios assessed in SR-PSU (Table 3-4). The list of FHA FEPs in SR-PSU has also been checked against FHA FEPs from other FEP catalogues in the FEP database. Future human actions and how they are handled in the safety assessment are described in detail in the **FHA report**.



**Table 3-4. FHA FEPs in SR-PSU and handling in the assessment.**

FEP number	Name	Scenario	Comment
FHA01	State of knowledge	All scenarios	It is assumed that the memory of the repository is lost after 300 years. Continuing support for assumptions made here will be available from the NEA Records, Knowledge and Memory (RK&M) project, on-going (NEA 2011).
FHA02	Societal development	All scenarios	Strongly linked to state of knowledge. It is assumed that the societal development allows for loss of memory of the repository.
FHA03	Technological development	All scenarios	Strongly linked to societal development. It is assumed that present day level of technology applies in all scenarios.
FHA04	Heat storage	Drilling into the repository	A heat storage system would only be constructed after geological investigation, potentially including drilling. Given current day technology this would result in discovery of the radioactive contamination and SFR. Thereafter any intrusion would be intentional and intruders are responsible for their own actions.
FHA05	Heat pump system	Drilling into the repository	With current technology water is not brought to the surface but drill cuttings are covered in drilling scenario.
FHA06	Geothermal energy	Drilling into the repository	Unlikely to occur, but exploratory drilling may be performed.
FHA07	Heating/cooling plant	No scenario selected.	Would require other technology than available at present.
FHA08	Drilled well	No FHA-scenario for abstracting and use of well water. Effects of drilling the well subsumed with FHA11.	Well water abstraction and use is included in the main calculation cases and not considered further here.
FHA09	Water management	Water management	Large scale activities are considered.
FHA10	Altered land use	No scenario selected	Treated in the biosphere analysis.
FHA11	Drilling	Drilling into the repository	A key case for FHA.
FHA12	Underground constructions	Drilling into the repository Underground constructions	Includes exploratory drilling direct into the repository but also effects of a rock cavern in the vicinity of the repository.
FHA13	Quarry	No scenario selected	Quarries to a few tens of meters are unlikely to have an impact on the repository. In addition, the quality of the bedrock was considered in siting to avoid the use of a site suitable for quarries. Mining is considered in FHA 12.
FHA14	Landfill	No FHA scenario selected	Unlikely that releases at a landfill would have an impact at the repository depth. Nevertheless, the upper limit of the dose consequence of this FEP can be estimated from the scenario 'Loss of barrier function – no sorption in the repository' and thus does not have to be further evaluated in the FHA analysis.
FHA15	Bombing, blasting, explosions and crashes	No scenario selected	Due to the large depth of SFR, explosions and crashes are considered highly unlikely to have any effect on the repository.
FHA16	Hazardous waste repository	Drilling into the repository	Similar argument to that for heat storage.
FHA17	Contamination with chemical substances or altering chemical conditions	No FHA-scenario selected	Unlikely that releases of chemicals would have an impact at the repository depth. Nevertheless, the upper limit of the dose consequence of this FEP can be estimated from the scenario 'Loss of barrier function – no sorption in the repository' and thus does not have to be further evaluated in the FHA analysis.



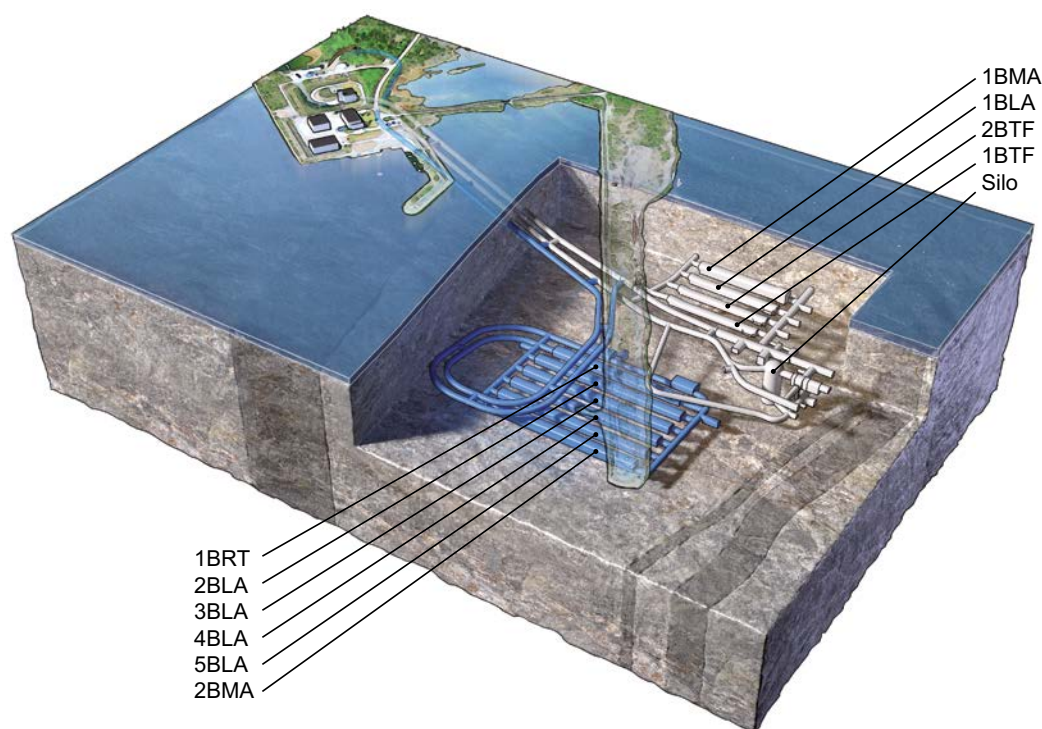
## 4 Initial state in the repository and its environs

### 4.1 Introduction

This chapter describes the initial state of the repository and its environs. The initial state is one of the main bases for the safety assessment, step 2 in the assessment methodology described in Chapter 2. The initial state is the point of departure for the analysis of the repository's performance after closure and it defines the expected state immediately after closure. The estimated year of closure is 2075. The description of the initial state is divided into two major parts; the first part describes the waste and the repository (Sections 4.2 and 4.3) and the second part describes the environs (Sections 4.4–4.8).

One part of the repository (SFR 1) is in operation, while the planned extension (SFR 3) is in a planning stage, see Figure 4-1. The initial state of the waste and the repository is based on realistic or pessimistic assumptions concerning their conditions at closure. For SFR 1 these assumptions are, as far as possible, based on verified and documented properties of disposed waste and installed repository barriers. In addition, a prognosis for additional waste and an assessment of changes in the properties up to the time of closure of the repository are considered. The initial state of SFR 3 is based on the reference design for this part (see Section 4.3) and the present prognosis for future wastes to be disposed. The information and the assumptions that serve as a basis for the initial state of the repository are compiled in the **Initial state report**, including general descriptions together with initial state values of variables applied to assess the safety of the repository.

The conditions in the environs at closure of the repository are assumed to be similar to the conditions today. The initial state of the environs is based largely on the site investigations that have been conducted on the site for SFR and documented in the Site Descriptive Model, SDM-PSU (SKB 2013e), the **Biosphere synthesis report** and the **Climate report**. The description of the environs at closure comprises information on the climate, surface system, bedrock, hydrogeology and groundwater chemistry.



**Figure 4-1.** Schematic illustration of SFR. The light grey part is the existing repository (SFR 1) and the blue part is the planned extension (SFR 3). The waste vaults in the figure are silo for intermediate-level waste, 1–2BMA vaults for intermediate-level waste, 1–2BTF for concrete tanks with intermediate level waste with low activity levels, 1–5BTA vaults for low-level waste and the BRT vault for reactor pressure vessels.

Deviations from the initial state may occur, through undetected mishaps, sabotage, failure to close the repository, etc. These are treated as initial state FEPs (see Section 3.2) and are used in scenario selection, described in Chapter 7.

#### **4.1.1 Inspection and control**

SKB has a quality management system that includes procedures for e.g. project management and safety audit. These procedures have served as a basis for framing the control documents, or quality assurance systems, that have governed the work with both SFR 1 and SFR 3. The quality management system meets the requirements in ISO 9001:2008.

Controls performed during the construction, inspection and measurement of conditions in the existing facility SFR 1 are documented. The existing control programme comprises e.g. measurements of inflows of groundwater and groundwater chemistry, and inspection of the physical condition of the waste vaults. The purpose of the programme is to examine changes in the system, for example ongoing changes like settlement of the silo, but also future impacts of blasting from construction of the SFR extension. A special control programme is defined for the silo, which has the most advanced engineered barrier system.

Methods for testing and inspecting SFR 3 during its construction (tunnels and waste vaults) will be developed and defined during the detailed design phase for the extension. It is foreseen that a special control programme will be defined for 2BMA, due to its new design with unreinforced caissons.

## **4.2 Waste**

This section, which describes the waste and the waste packaging, is a summary of the information contained in the **Initial state report**.

### **4.2.1 Origin of the waste**

#### ***Operational waste***

Most of the waste in SFR 1 comes from the operation of the Swedish nuclear power plants. Radioactive waste is produced during nuclear fission in the reactor core, giving rise to fission products such as Cs-137 and I-131, as well as neutrons. The neutrons can cause more fission of uranium in the fuel. As a result of neutron absorption and transformation of uranium in the fuel, transuranic elements such as plutonium and americium are formed. Like the fission products, these transuranics are formed in the fuel itself and will only contaminate the reactor water if the fuel is damaged.

The largest activity quantities in the reactor water derive from activation of substances outside the fuel rods themselves. These substances occur dissolved or finely dispersed in the reactor water and come from corrosion of material surfaces, but they may also come from substances on surfaces near or within the core that are activated directly and then transferred to the reactor water.

The reactor water in the primary circuit undergoes cleanup to remove the radionuclides. The reactor water is purified in the reactor's cleanup circuits by means of ion-exchange resins that adsorb (retain, exchange) radionuclides that occur as ions in the reactor water. The ion-exchange resins also contain (or serve as) filters to remove "crud", i.e. dispersed particles consisting of oxides/hydroxides of engineering materials.

Even though most of the radionuclide activity that has left the core is removed in the cleanup system, a small amount is spread to other systems. Relatively large volumes of ion-exchange resins and mechanical filter resins are used in the boiling water reactors for cleanup of the water that condenses in the condenser. Due to the fact that small quantities of radionuclides are transferred from the reactor to the turbines, this water and its filter resins become weakly radioactive.

Additional waste consisting of ion-exchange resin, mechanical filter resin and precipitation sludge arises in the water cleanup system.

Some radionuclides are released from the spent fuel stored in storage pools at the nuclear power plants and Clab (Central interim storage for spent fuel). Ion-exchange resins are used in the water cleanup systems in these plants as well.

Solid waste is also generated at nuclear facilities. Some solid waste consists of components of the primary system or other active systems, but most consists of material that has been brought into a classified area, used, contaminated and then discarded.

In addition to the waste from the nuclear power plants and Clink (Central interim storage and encapsulation plant for spent fuel), operational waste is produced by the activities at Studsvik Nuclear AB, AB SVAFO and has arisen from the Ågesta nuclear reactor. Radioactive wastes also arise in other industrial activities, research and medical care.

### ***Decommissioning waste***

Large quantities of scrap metal and concrete are generated during decommissioning and dismantling of nuclear power plants. As in the case of operational waste, the largest quantities consist of low- and intermediate-level waste and are allocated to SFR. Materials that have been close to or within the reactor core, such as control rods and other core components, are classified as long-lived and allocated to the repository for long-lived low- and intermediate-level waste, SFL.

The boiling water reactors, BWRs, have an inner moderator tank and an outer reactor pressure vessel (RPV). The RPVs have such low activity that they can be deposited in SFR after decontamination.

The activity in the decommissioning waste arises due to both fission and activation. Among the wastes allocated to SFR, the RPVs in particular contain induced activity.

During decommissioning, decontamination will be used to permit clearance of material. Decontamination generates solutions that are cleaned with ion-exchange resins that are allocated to SFR.

As during operation, secondary waste is formed during decommissioning when material is brought into a classified area, used, contaminated and then discarded.

### **4.2.2 Material types**

A large part of the radioactivity in the operational waste is in the waste from different water cleanup systems. This waste consists of bead resin, powdered resin, mechanical filter aids and precipitation sludge. The ion-exchange resins consist of organic polymers with acidic or basic groups, making them capable of cation or anion exchange.

A relatively large fraction of the operational waste consists of metals, above all carbon steel and stainless steel. Scrap metal arises mainly during maintenance outages when equipment is discarded, modified or renovated.

The largest volume of operational waste consists of combustible solid waste. Due to incineration at Studsvik or local at-plant disposal in near-surface repositories, the volume remaining for disposal in SFR is comparatively small. The waste consists mainly of cellulose (paper, cotton and wood) and plastics (including PVC, polystyrene, polyethylene and polypropylene). Ashes from incineration of this type of waste are also deposited in SFR.

In addition to these materials, operational waste also occurs in the form of mineral wool, brick and concrete, as well as small quantities of other materials.

Management of radioactive material that does not come from nuclear activities is coordinated by Studsvik Nuclear AB, which provides services regarding the final disposal of this waste. Examples of such waste are spent radiation sources, equipment containing radiation sources, waste from radiotherapy units, radioactively contaminated material and radioactive chemicals. This gives rise to scrap metal in the form of iron, stainless steel and aluminium, and trash in the form of residual products such as ashes and soot from incineration of combustible waste such as clothing and rags.

### 4.2.3 Waste packaging

Nearly all waste that will be disposed of in SFR is contained in some kind of waste packaging. The exception is large components such as RPVs from BWRs. The different types of waste packaging in use or to be used in SFR 1 and SFR 3 are shown in Figure 4-2.

#### ISO container

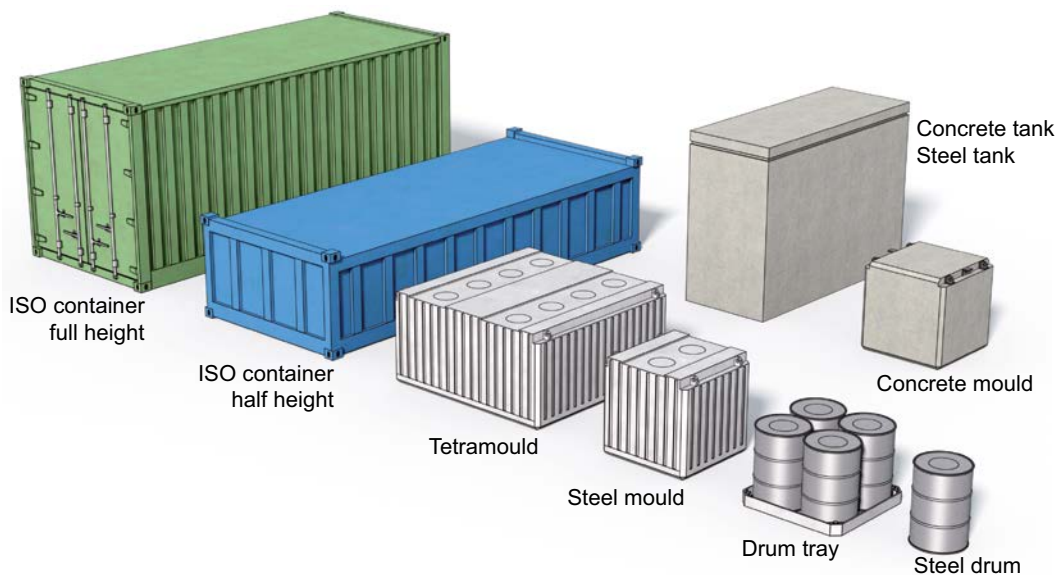
ISO containers of steel plate are used for low-level solid waste from both operations and decommissioning, which is deposited in the BLA vaults. Inside the containers, the waste is packed in boxes, bales, drums or directly in the container. The containers are made of carbon steel and consist of 20-foot full- and half-height containers and 10-foot full- and half-height containers. A 20-foot full-height container has outside dimensions of 6.1 m×2.5 m×2.6 m (L×W×H).

#### Tetramould

SKB plans to use tetramoulds of steel plate for intermediate-level decommissioning waste to be deposited in 2BMA. The waste in tetramoulds consists primarily of concrete and steel, but also sand. The waste is grouted with concrete. The tetramoulds are made of carbon steel. A tetramould is four times as big as a steel mould. The outside dimensions of the tetramould are 2.4 m×2.4 m×1.2 m (L×W×H).

#### Steel mould

Steel moulds are used primarily for cement- or bitumen-solidified waste (ion-exchange resins, filter aids, evaporator concentrates) or concrete-embedded solid waste, which is deposited in the silo and 1–2BMA. The steel moulds are made of carbon steel. The outside dimensions of the steel moulds are 1.2 m×1.2 m×1.2 m.



**Figure 4-2.** Schematic illustration of waste packaging used or intended to be used in SFR. Note that the steel tanks only are used for intermediate storage of long-lived radioactive waste.

### **Steel drum, drum tray**

Steel drums, usually handled on drum trays, are used primarily for cement- and bitumen-solidified waste, which is deposited in the silo, and 1BMA, as well as ashes, which are deposited in 1BTF. Furthermore, drums are used as inner packaging in containers that are deposited in the BLA vaults. The drums are normally made of carbon steel, but some drums are made of stainless steel. The standard dimensions of the steel drums are: diameter 0.6 m and height 0.9 m. A drum tray enables four drums to be handled at the same time with outside dimensions of 1.2 m×1.2 m×0.9 m (L×W×H).

### **Concrete tank**

Concrete tanks are used for dewatered low-level ion-exchange resins, filter aids and sludge, which are deposited in 1–2BTF. The concrete tanks are made of 15-cm-thick reinforced concrete. The outside dimensions of a concrete tank are 3.3 m×1.3 m×2.3 m (L×W×H).

### **Concrete mould**

Concrete moulds are used primarily for solidified waste (ion-exchange resins, filter aids, evaporator concentrates) or concrete-embedded solid waste that is deposited in the silo, 1–2BMA and 1BTF. Concrete moulds are made of reinforced concrete, normally with a wall thickness of 10 cm, but sometimes thicker. The outside dimensions of the concrete mould are 1.2 m×1.2 m×1.2 m.

## **4.2.4 Waste volumes, material quantities and radionuclide inventory**

Waste volumes, material quantities and radionuclide inventories for the waste vaults are presented in this section. The material quantities are taken from the **Initial state report**. The material quantities and radionuclide inventories are calculated from the average in each waste type given in the current prognosis in the inventory report (SKB 2013a and in SKBdoc 1481419 for Mo-93) and the number of packages of each waste type in the waste vaults given in the **Initial state report**. The safety analysis shows the necessity to limit the amounts of cellulose and aluminium/zinc, see Chapter 11. The prognosis of these materials is hence too high.

### **Waste volumes in different vaults**

The waste volumes allocated to different waste vaults are shown in Figure 1-4. The waste volumes are based on the current prognosis given in the inventory report (SKB 2013a) and the number of packages of each waste type in the waste vaults given in the **Initial state report**. The volumes of secondary decommissioning waste (wastes that arise during decommissioning, mostly materials that have been brought into a classified area, used, contaminated and discarded) is very uncertain and has therefore been shown separately, in red, in the figure. The waste volume allocated to SFR 1 according to the current prognosis is almost 60,000 m<sup>3</sup> of operational waste and less than 200 m<sup>3</sup> of decommissioning waste in the silo. The waste volume allocated to SFR 3 according to the current prognosis is almost 100,000 m<sup>3</sup>, whereof about 80% is decommissioning waste, about 10% is operational waste and less than 10% is secondary decommissioning waste.

### **Waste in 1–2BMA**

The 1–2BMA vaults are intended for intermediate-level waste. The waste in 1BMA is operational waste, which consists of approximately 75 volume percent cement- or bitumen-solidified waste (ion-exchange resins, filter aids, evaporator concentrates, sludge) and approximately 25 volume percent concrete-embedded waste (trash and scrap metal). Trash and scrap metal includes air filters, oil, blasting sand, electric cables, and water and oil filters. The waste in 2BMA consists primarily of decommissioning waste in the form of metal and concrete plus a smaller fraction of operational waste of the same types as in 1BMA. Material quantities in waste form and packaging plus corrosion surface areas and void are given in Table 4-1.

**Table 4-1. Quantities of different materials (waste form and packaging) in 1–2BMA at closure plus corrosion surface areas and void (SKB 2013a, Initial state report).**

Material	Weight [kg]		
	1BMA	2BMA	Total in 1–2BMA
Aluminium/Zinc	$7.13 \cdot 10^3$	$2.06 \cdot 10^4$ a)	$2.77 \cdot 10^4$ a)
Ashes	0	$1.53 \cdot 10^5$	$1.53 \cdot 10^5$
Concrete	$8.52 \cdot 10^6$	$1.73 \cdot 10^7$	$2.58 \cdot 10^7$
Bitumen	$1.93 \cdot 10^6$	0	$1.93 \cdot 10^6$
Cellulose	$7.95 \cdot 10^4$	$7.06 \cdot 10^4$ a)	$1.50 \cdot 10^5$ a)
Cement	$4.39 \cdot 10^6$	$4.50 \cdot 10^5$	$4.84 \cdot 10^6$
Filter aids	$8.34 \cdot 10^4$	$1.63 \cdot 10^2$	$8.35 \cdot 10^4$
Evaporator concentrates	$2.99 \cdot 10^5$	$1.34 \cdot 10^5$	$4.34 \cdot 10^5$
Ion-exchange resins	$2.08 \cdot 10^6$	$4.76 \cdot 10^4$	$2.13 \cdot 10^6$
Iron/steel	$2.65 \cdot 10^6$	$9.48 \cdot 10^6$	$1.21 \cdot 10^7$
Sand	0	$1.06 \cdot 10^5$	$1.06 \cdot 10^5$
Sludge	$8.61 \cdot 10^4$	$1.73 \cdot 10^4$	$1.03 \cdot 10^5$
Other inorganic	$2.88 \cdot 10^4$	$8.77 \cdot 10^4$	$1.16 \cdot 10^5$
Other organic	$2.06 \cdot 10^5$	$1.49 \cdot 10^5$	$3.56 \cdot 10^5$
Aluminium/Zinc [m <sup>2</sup> ] a, b)	$1.01 \cdot 10^3$	$3.15 \cdot 10^3$	$4.16 \cdot 10^3$
Iron/steel [m <sup>2</sup> ] b)	$1.15 \cdot 10^5$	$4.38 \cdot 10^5$	$5.53 \cdot 10^5$
Void [m <sup>3</sup> ] c)	$1.83 \cdot 10^3$	$2.51 \cdot 10^3$	$4.33 \cdot 10^3$

a) Initial estimate from the prognosis (SKB 2013a). The safety analysis shows the necessity to limit the amounts, see Chapter 11.

b) The corrosion surface area is defined as the area that will be exposed to corrosion. Metal surfaces in contact with bitumen are not included in the definition of corrosion surface area.

c) Void, which is given in m<sup>3</sup> in the above table, is empty space inside the waste packaging i.e. above and between wastes and does not include air-filled pores.

### **Waste in 1–2BTF**

The waste in 1–2BTF is primarily dewatered ion-exchange resins. Ashes and some cement-solidified ion-exchange resins are also deposited in 1BTF. Material quantities in waste form and packaging plus corrosion surface areas and void are given in Table 4-2.

**Table 4-2. Quantities of different materials (waste form and packaging) in 1–2BTF at closure plus corrosion surface areas and void (SKB 2013a, Initial state report).**

Material	Weight [kg]		
	1BTF	2BTF	Total in 1–2BTF
Aluminium/Zinc	$5.28 \cdot 10^4$ a)	0	$5.28 \cdot 10^4$ a)
Ashes	$5.19 \cdot 10^5$	0	$5.19 \cdot 10^5$
Concrete	$6.52 \cdot 10^6$	$7.89 \cdot 10^6$	$1.44 \cdot 10^7$
Cellulose	$1.07 \cdot 10^3$	0	$1.07 \cdot 10^3$
Cement	$2.37 \cdot 10^5$	0	$2.37 \cdot 10^5$
Filter aids	$7.23 \cdot 10^4$	$1.32 \cdot 10^5$	$2.04 \cdot 10^5$
Ion-exchange resins	$4.39 \cdot 10^5$	$8.12 \cdot 10^5$	$1.25 \cdot 10^6$
Iron/steel	$1.32 \cdot 10^6$	$1.79 \cdot 10^6$	$3.11 \cdot 10^6$
Sludge	$2.53 \cdot 10^4$	$4.37 \cdot 10^4$	$6.90 \cdot 10^4$
Other organic	$4.77 \cdot 10^4$	$8.46 \cdot 10^4$	$1.32 \cdot 10^5$
Aluminium/Zinc [m <sup>2</sup> ] b)	$7.79 \cdot 10^3$ a)	0	$7.79 \cdot 10^3$ a)
Iron/steel [m <sup>2</sup> ] b)	$7.74 \cdot 10^4$	$3.94 \cdot 10^4$	$1.17 \cdot 10^5$
Void [m <sup>3</sup> ] c)	$5.23 \cdot 10^2$	$6.31 \cdot 10^2$	$1.15 \cdot 10^3$

a) Initial estimate from the prognosis (SKB 2013a). The safety analysis shows the necessity to limit the amounts, see Chapter 11.

b) The corrosion surface area is defined as the area that will be exposed to corrosion. Metal surfaces in contact with bitumen are not included in the definition of corrosion surface area.

c) Void, which is given in m<sup>3</sup> in the above table, is empty space inside the waste packaging i.e. above and between wastes and does not include air-filled pores.



### **Waste in silo**

The silo is intended for intermediate-level waste. The waste consists of approximately 85 volume percent cement- or bitumen-solidified waste (ion-exchange resins, filter aids, sludge) and approximately 15 volume percent concrete-embedded waste (trash and scrap metal). Material quantities in waste form and packaging plus corrosion surface areas and void are given in Table 4-3.

**Table 4-3. Quantities of different materials (waste form and packaging) in silo at closure plus corrosion surface areas and void (SKB 2013a, Initial state report).**

Material	Weight [kg]
Aluminium/Zinc a)	$8.26 \cdot 10^3$
Concrete	$1.17 \cdot 10^7$
Bitumen	$1.06 \cdot 10^6$
Cellulose	$1.80 \cdot 10^4$
Cement	$1.22 \cdot 10^7$
Filter aids	$1.01 \cdot 10^4$
Ion-exchange resins	$3.31 \cdot 10^6$
Iron/steel	$4.94 \cdot 10^6$
Sludge	$3.53 \cdot 10^4$
Other inorganic	$1.07 \cdot 10^6$
Other organic	$5.31 \cdot 10^4$
Aluminium/Zinc [m <sup>2</sup> ] a,b)	$1.24 \cdot 10^3$
Iron/steel [m <sup>2</sup> ] b)	$2.21 \cdot 10^5$
Void [m <sup>3</sup> ] c)	$2.14 \cdot 10^3$

a) Initial estimate from the prognosis (SKB 2013a). The safety analysis shows the necessity to limit the amounts, see Chapter 11.

b) The corrosion surface area is defined as the area that will be exposed to corrosion. Metal surfaces in contact with bitumen are not included in the definition of corrosion surface area.

c) Void, which is given in m<sup>3</sup> in the above table, is empty space inside the waste packaging i.e. above and between wastes and does not include air-filled pores.

### **Waste in 1–5BLA**

The BLA vaults are intended for low-level waste. Operational waste that consists primarily of trash and scrap metal, but also about 5 volume percent cement- or bitumen-solidified waste (ion-exchange resins, evaporator concentrates and sludge), is deposited in 1BLA. The waste in 2–5BLA includes a small fraction of operational waste in the form of trash and scrap metal, while most of it is decommissioning waste consisting of concrete, metals, sand, asphalt etc. Material quantities in waste form and packaging plus corrosion surface areas and void are given in Table 4-4.

**Table 4-4. Quantities of different materials (waste form and packaging) in 1–5BLA at closure plus corrosion surface areas and void (SKB 2013a, Initial state report).**

Material	Weight [kg]		
	1BLA	2–5BLA	Total in 1–5BLA
Aluminium/Zinc a)	$6.30 \cdot 10^4$	$6.98 \cdot 10^4$	$1.33 \cdot 10^5$
Asphalt, gravel, soil	0	$3.60 \cdot 10^6$	$3.60 \cdot 10^6$
Concrete	$2.43 \cdot 10^5$	$1.79 \cdot 10^7$	$1.81 \cdot 10^7$
Bitumen	$1.18 \cdot 10^5$	0	$1.18 \cdot 10^5$
Cellulose	$3.05 \cdot 10^5$	$3.61 \cdot 10^5$	$6.66 \cdot 10^5$
Cement	$7.50 \cdot 10^4$	0	$7.50 \cdot 10^4$
Evaporator concentrates	$2.70 \cdot 10^2$	0	$2.70 \cdot 10^2$
Ion-exchange resins	$9.74 \cdot 10^4$	0	$9.74 \cdot 10^4$
Iron/steel	$3.77 \cdot 10^6$	$3.52 \cdot 10^7$	$3.89 \cdot 10^7$
Sand	0	$5.26 \cdot 10^6$	$5.26 \cdot 10^6$
Sludge	$7.25 \cdot 10^2$	0	$7.25 \cdot 10^2$
Other inorganic	$1.84 \cdot 10^5$	$2.51 \cdot 10^5$	$4.35 \cdot 10^5$
Other organic	$1.47 \cdot 10^6$	$2.03 \cdot 10^6$	$3.50 \cdot 10^6$
Aluminium/Zinc [m <sup>2</sup> ] a,b)	$9.33 \cdot 10^3$	$1.04 \cdot 10^4$	$1.98 \cdot 10^4$
Iron/steel [m <sup>2</sup> ] b)	$2.29 \cdot 10^5$	$1.84 \cdot 10^6$	$2.06 \cdot 10^6$
Void [m <sup>3</sup> ] c)	$4.50 \cdot 10^3$	$3.47 \cdot 10^4$	$3.92 \cdot 10^4$

a) Initial estimate from the prognosis (SKB 2013a). The safety analysis shows the necessity to limit the amounts, see Chapter 11.

b) The corrosion surface area is defined as the area that will be exposed to corrosion. Metal surfaces in contact with bitumen are not included in the definition of corrosion surface area.

c) Void, which is given in m<sup>3</sup> in the above table, is empty space inside the waste packaging i.e. above and between wastes and does not include air-filled pores.

### **Waste in BRT**

The BRT vault is intended for the reactor pressure vessels (RPVs) from the boiling water reactors, BWRs. Material quantities in reactor pressure vessels plus corrosion surface areas and void (i.e. inner volume of RPVs) are given in Table 4-5.

### **Radionuclide inventory**

The best estimate radionuclide inventory, given in Table 4-6, is calculated from the average radionuclide inventory in each waste type package (SKB 2013a, SKBdoc 1481419 for Mo-93) and the number of packages of each waste type in the waste vaults given in the **Initial state report**. A radionuclide inventory including uncertainties has been calculated from the best estimate inventory and uncertainties for different wastes (SKBdoc 1427105), see Table 4-7. The uncertainties include measurement uncertainties, uncertainties in correlation factors and uncertainties in other methods used to calculate the best estimate inventory. Uncertainties in the amount of waste have not been included. No activity has been assigned to the decommissioning waste from AB SVAFO and Studsvik AB, due to lack of information. The estimated uncertainties in the radionuclide inventory do not account for this. Other uncertainties not included are for example changes due to possible higher burn-up or changed fuel composition in the future. The included uncertainties are further described in the inventory report (SKB 2013a). An on-going study treats uncertainties for the legacy wastes already deposited in 1BLA (waste type S.14).

**Table 4-5. Quantities of waste materials in BRT at closure plus corrosion surface areas and void (SKB 2013a, Initial state report).**

Material	Weight [kg]
Iron/steel	$5.55 \cdot 10^6$
Iron/steel [m <sup>2</sup> ]	$7.24 \cdot 10^3$
Void [m <sup>3</sup> ]*	$4.67 \cdot 10^3$

\* Inner volume that will be filled with grout, see Section 4.3.7.

**Table 4-6. Best estimate radionuclide inventory [Bq] at year 2075 (Initial state report).**

Nuclide	1BMA	2BMA	1BTF	2BTF	Silo	1BLA	2-5BLA	BRT	Total
H-3	8.09E+08	3.31E+12	6.82E+07	1.07E+08	8.97E+09	2.00E+08	1.94E+11		3.52E+12
Be-10	2.21E+05	2.19E+04	1.37E+04	2.48E+04	9.89E+05	6.53E+02	1.26E+03		1.27E+06
C-14 org*	1.47E+11	3.96E+09	9.84E+09	6.07E+09	7.56E+11	7.91E+07	2.25E+08		9.23E+11
C-14 inorg*	1.90E+12	1.44E+10	1.89E+11	2.69E+11	2.72E+12	4.03E+09	9.27E+08		5.10E+12
C-14 ind*		5.09E+09					1.19E+09	1.02E+10	1.65E+10
Cl-36	3.34E+08	2.02E+08	1.44E+07	1.66E+07	8.94E+08	2.17E+07	4.60E+07	7.21E+06	1.54E+09
Ca-41		1.56E+10					3.91E+09		1.95E+10
Fe-55	5.35E+10	1.05E+11	8.33E+07	1.14E+08	2.73E+12	8.78E+06	4.45E+08	1.49E+10	2.91E+12
Co-60	4.08E+11	1.99E+12	1.67E+10	2.36E+10	1.29E+13	1.03E+09	2.59E+10	1.93E+11	1.55E+13
Ni-59	2.10E+12	9.50E+11	3.31E+10	3.83E+10	6.85E+12	3.99E+09	1.15E+10	1.60E+11	1.01E+13
Ni-63	1.47E+14	9.23E+13	2.04E+12	2.27E+12	5.48E+14	3.04E+11	1.12E+12	1.44E+13	8.07E+14
Se-79	2.10E+08	7.29E+06	1.57E+07	1.54E+07	1.05E+09	4.00E+05	5.94E+06		1.31E+09
Sr-90	5.49E+11	3.60E+11	3.48E+10	5.76E+10	3.61E+12	7.42E+08	2.40E+10	2.32E+10	4.66E+12
Zr-93	3.68E+08	1.06E+09	2.29E+07	4.14E+07	4.48E+09	1.09E+06	2.95E+07	1.84E+08	6.19E+09
Nb-93m	1.73E+10	1.31E+13	1.44E+09	2.35E+09	9.33E+12	7.68E+07	1.34E+11	1.06E+12	2.36E+13
Nb-94	3.67E+09	9.12E+10	2.53E+08	4.13E+08	8.67E+10	3.14E+07	9.81E+08	7.94E+09	1.91E+11
Mo-93	1.46E+09	4.52E+09	2.56E+08	2.36E+08	1.96E+10	1.01E+08	9.01E+07	3.00E+09	2.93E+10
Tc-99	6.22E+09	1.42E+09	2.30E+09	5.45E+08	5.00E+10	1.85E+09	4.98E+08	4.49E+08	6.32E+10
Pd-107	5.25E+07	2.55E+09	3.92E+06	3.86E+06	2.75E+08	1.00E+05	1.72E+06		2.89E+09
Ag-108m	1.95E+10	4.06E+10	1.51E+09	2.21E+09	2.30E+11	1.94E+08	1.53E+09	1.62E+09	2.97E+11
Cd-113m	7.98E+08	9.32E+07	7.67E+07	6.34E+07	9.58E+09	1.96E+06	6.13E+06		1.06E+10
In-115		3.13E+05							3.13E+05
Sn-126	2.62E+07	1.75E+07	1.96E+06	1.93E+06	2.05E+08	5.00E+04	7.93E+06	7.53E+05	2.62E+08
Sb-125	4.37E+07	2.62E+08	7.47E+06	1.04E+07	1.32E+11	4.74E+05	4.46E+06	1.34E+07	1.32E+11
I-129	1.46E+08	7.67E+06	2.27E+07	1.02E+07	9.84E+08	4.35E+05	1.94E+06		1.17E+09
Cs-134	1.45E+08	2.26E+08	7.10E+04	8.86E+04	2.20E+11	1.58E+04	1.39E+06		2.20E+11
Cs-135	8.41E+08	5.33E+07	1.03E+08	1.85E+07	4.47E+09	3.07E+06	1.75E+08		5.67E+09
Cs-137	8.15E+12	8.95E+11	7.12E+11	6.22E+11	5.97E+13	1.84E+10	4.95E+11		7.05E+13
Ba-133	4.89E+07	1.43E+08	4.03E+06	6.19E+06	6.16E+08	2.20E+05	1.26E+07		8.31E+08
Pm-147	3.71E+08	4.06E+08	3.84E+06	4.57E+06	3.59E+11	3.02E+05	1.19E+06	1.37E+06	3.60E+11
Sm-151	8.26E+10	3.55E+10	6.51E+09	6.13E+09	4.63E+11	1.68E+08	5.88E+09	3.42E+08	6.00E+11
Eu-152	9.47E+07	1.33E+11	6.19E+07	6.54E+06	8.64E+08	1.02E+08	1.73E+10	5.41E+05	1.52E+11
Eu-154	2.33E+10	6.83E+09	1.98E+09	1.80E+09	5.24E+11	4.01E+07	2.67E+08	9.27E+07	5.59E+11
Eu-155	1.02E+09	3.74E+08	4.96E+07	5.83E+07	9.96E+10	1.54E+06	1.16E+07	2.40E+06	1.01E+11
Ho-166m	1.41E+09	5.22E+08	8.79E+07	1.59E+08	6.83E+09	4.18E+06	9.03E+07	7.99E+03	9.10E+09
U-232	8.85E+04	1.46E+05	1.62E+04	6.73E+03	6.20E+05	2.34E+03	9.35E+03	6.86E+03	8.96E+05
U-234	6.66E+06	3.04E+06	9.86E+05	4.55E+05	3.58E+07	1.33E+05	4.38E+05		4.75E+07
U-235	3.00E+06	7.82E+04	1.84E+07	1.12E+05	1.42E+07	2.98E+08	3.23E+08	1.49E+01	6.57E+08
U-236	2.64E+06	6.00E+06	4.02E+05	3.55E+05	1.58E+07	3.99E+04	2.06E+05	3.92E+05	2.59E+07
U-238	5.95E+06	1.23E+06	8.55E+05	8.75E+05	3.28E+07	7.33E+08	1.77E+08		9.52E+08
Np-237	2.73E+07	7.68E+06	1.07E+06	1.98E+06	5.36E+08	6.75E+04	2.61E+05	4.70E+05	5.75E+08
Pu-238	7.52E+09	4.42E+10	2.09E+09	4.56E+08	7.29E+10	3.47E+08	1.52E+09	2.72E+09	1.32E+11
Pu-239	2.77E+09	6.78E+09	4.68E+08	1.89E+08	1.70E+10	6.60E+07	2.77E+08	4.16E+08	2.80E+10
Pu-240	3.87E+09	9.21E+09	5.20E+08	2.65E+08	2.39E+10	6.74E+07	2.95E+08	5.92E+08	3.87E+10
Pu-241	2.40E+10	1.66E+11	7.30E+09	2.42E+09	3.07E+11	1.29E+09	5.74E+09	9.05E+09	5.23E+11
Pu-242	2.00E+07	5.02E+07	2.96E+06	1.37E+06	1.23E+08	3.99E+05	1.71E+06	3.11E+06	2.03E+08
Am-241	2.91E+10	4.12E+10	6.14E+09	1.83E+09	2.32E+13	5.23E+08	1.94E+09	1.99E+09	2.32E+13
Am-242m	4.46E+07	1.83E+08	7.34E+06	3.21E+06	3.22E+08	1.02E+06	4.84E+06	1.32E+07	5.79E+08
Am-243	2.02E+08	6.62E+08	3.25E+07	1.78E+07	1.60E+09	4.00E+06	1.86E+07	4.14E+07	2.57E+09
Cm-243	1.85E+07	1.03E+08	3.82E+06	4.15E+05	1.89E+08	7.58E+05	3.40E+06	6.38E+06	3.25E+08
Cm-244	6.73E+08	1.07E+10	2.68E+08	2.84E+07	9.26E+09	5.39E+07	2.80E+08	6.76E+08	2.19E+10
Cm-245	1.99E+06	1.01E+07	2.95E+05	1.36E+05	1.49E+07	3.97E+04	2.18E+05	6.83E+05	2.84E+07
Cm-246	5.27E+05	3.34E+06	7.82E+04	3.60E+04	4.29E+06	1.05E+04	6.61E+04	2.24E+05	8.58E+06
Total	1.60E+14	1.14E+14	3.06E+12	3.30E+12	6.72E+14	3.39E+11	2.05E+12	1.59E+13	9.71E+14

\* C-14 has been divided into organic, inorganic and induced activity.

**Table 4-7. High radionuclide inventory [Bq] at year 2075 (calculated from the best estimate inventory including uncertainties (95th percentile) (Initial state report)).**

Nuclide	1BMA	2BMA	1BTF	2BTF	Silo	1BLA	2-5BLA	BRT	Total	Ratio**
H-3	4.06E+10	2.02E+13	3.41E+09	5.38E+09	4.57E+11	1.01E+10	5.43E+11		2.12E+13	6.04
Be-10	1.11E+07	9.85E+05	6.88E+05	1.24E+06	4.98E+07	3.42E+04	2.49E+04		6.38E+07	50.2
C-14 org*	2.01E+11	7.49E+09	1.35E+10	8.31E+09	1.04E+12	1.08E+08	1.21E+09		1.27E+12	1.38
C-14 inorg*	2.60E+12	2.63E+10	2.58E+11	3.67E+11	3.75E+12	5.51E+09	4.98E+09		7.01E+12	1.37
C-14 ind*		1.76E+10					6.41E+09	1.85E+10	4.26E+10	2.59
Cl-36	6.67E+08	8.00E+08	4.81E+07	4.06E+07	3.91E+09	2.88E+07	1.13E+08	1.31E+07	5.63E+09	3.66
Ca-41		6.07E+10					1.01E+10		7.08E+10	3.63
Fe-55	2.72E+11	4.65E+11	4.17E+08	5.71E+08	1.52E+13	5.05E+07	2.64E+09	2.72E+10	1.59E+13	5.48
Co-60	4.74E+11	3.74E+12	1.71E+10	2.41E+10	2.40E+13	2.01E+09	1.66E+11	3.51E+11	2.88E+13	1.85
Ni-59	6.30E+12	2.12E+12	1.03E+11	1.16E+11	2.09E+13	1.27E+10	6.62E+10	2.91E+11	2.99E+13	2.95
Ni-63	4.40E+14	2.02E+14	6.43E+12	6.88E+12	1.67E+15	9.57E+11	6.57E+12	2.62E+13	2.36E+15	2.93
Se-79	1.05E+10	3.77E+08	7.86E+08	7.71E+08	5.30E+10	2.06E+07	5.84E+07		6.55E+10	50.2
Sr-90	7.27E+11	8.68E+11	5.14E+10	1.29E+11	5.16E+12	2.92E+09	1.80E+11	4.23E+10	7.16E+12	1.54
Zr-93	1.84E+10	3.87E+09	1.15E+09	2.07E+09	1.00E+11	5.69E+07	2.09E+08	3.36E+08	1.26E+11	20.4
Nb-93m	3.46E+11	2.50E+13	2.88E+10	4.70E+10	4.00E+13	1.66E+09	8.69E+11	1.92E+12	6.81E+13	2.88
Nb-94	1.84E+10	1.80E+11	1.27E+09	2.07E+09	3.61E+11	1.95E+08	6.15E+09	1.45E+10	5.84E+11	3.05
Mo-93	2.00E+09	8.65E+09	3.50E+08	3.22E+08	4.23E+10	1.39E+08	3.09E+08	5.46E+09	5.95E+10	2.03
Tc-99	1.22E+10	5.01E+09	8.47E+09	7.54E+08	1.97E+11	6.66E+09	3.06E+09	8.19E+08	2.34E+11	3.71
Pd-107	2.10E+09	4.72E+09	1.57E+08	1.54E+08	1.07E+10	4.14E+06	1.39E+07		1.79E+10	6.19
Ag-108m	9.74E+11	1.73E+11	7.56E+10	1.11E+11	5.09E+12	9.85E+09	8.46E+09	2.96E+09	6.44E+12	21.7
Cd-113m	4.00E+10	4.15E+09	3.85E+09	3.17E+09	5.03E+11	1.04E+08	1.79E+08		5.55E+11	52.2
In-115		8.28E+05							8.28E+05	2.65
Sn-126	1.05E+09	7.45E+07	7.87E+07	7.72E+07	5.91E+09	2.07E+06	5.58E+07	1.37E+06	7.25E+09	27.7
Sb-125	4.61E+08	1.27E+09	7.47E+07	1.04E+08	1.54E+12	5.55E+06	3.03E+07	2.45E+07	1.54E+12	11.6
I-129	3.05E+08	4.50E+07	9.17E+07	1.40E+07	3.29E+09	1.38E+06	1.45E+07		3.76E+09	3.20
Cs-134	1.93E+08	3.30E+08	8.54E+04	1.06E+05	5.85E+11	4.05E+04	9.24E+06		5.86E+11	2.66
Cs-135	1.28E+09	3.22E+08	2.46E+08	2.53E+07	9.94E+09	6.38E+06	1.21E+09		1.30E+10	2.30
Cs-137	8.35E+12	4.58E+12	8.05E+11	6.31E+11	8.99E+13	3.14E+10	3.45E+12		1.08E+14	1.53
Ba-133	9.99E+07	5.30E+08	8.09E+06	1.24E+07	1.36E+09	5.90E+05	3.33E+07		2.05E+09	2.47
Pm-147	7.63E+08	8.59E+08	7.68E+06	9.14E+06	1.18E+12	9.08E+05	5.51E+06	2.49E+06	1.18E+12	3.28
Sm-151	1.66E+11	1.36E+11	1.33E+10	1.23E+10	1.03E+12	3.97E+08	1.58E+10	6.23E+08	1.38E+12	2.29
Eu-152	2.07E+08	4.78E+11	1.24E+08	1.31E+07	2.29E+09	2.22E+08	4.57E+10	9.86E+05	5.26E+11	3.47
Eu-154	4.71E+10	1.93E+10	4.04E+09	3.61E+09	1.48E+12	1.03E+08	8.01E+08	1.69E+08	1.55E+12	2.78
Eu-155	2.07E+09	9.72E+08	1.00E+08	1.17E+08	3.17E+11	4.45E+06	3.48E+07	4.37E+06	3.20E+11	3.17
Ho-166m	2.83E+09	2.11E+09	1.78E+08	3.21E+08	1.41E+10	1.04E+07	2.39E+08	1.46E+04	1.98E+10	2.17
U-232	1.99E+05	3.46E+05	3.28E+04	1.41E+04	1.57E+06	7.61E+03	3.66E+04	1.25E+04	2.22E+06	2.48
U-234	1.47E+07	9.73E+06	2.00E+06	9.57E+05	8.44E+07	4.29E+05	1.44E+06		1.14E+08	2.39
U-235	6.29E+06	2.32E+05	3.69E+07	2.33E+05	2.98E+07	7.21E+08	1.03E+09	2.71E+01	1.82E+09	2.77
U-236	5.75E+06	1.21E+07	8.22E+05	7.44E+05	4.13E+07	1.29E+05	9.61E+05	7.14E+05	6.25E+07	2.42
U-238	1.27E+07	3.92E+06	1.76E+06	1.83E+06	7.24E+07	1.55E+09	4.47E+08		2.09E+09	2.19
Np-237	5.73E+07	1.58E+07	2.19E+06	4.18E+06	1.61E+09	2.09E+05	1.06E+06	8.57E+05	1.69E+09	2.94
Pu-238	1.30E+10	9.11E+10	3.98E+09	6.41E+08	1.78E+11	1.12E+09	6.22E+09	4.95E+09	2.99E+11	2.27
Pu-239	4.10E+09	1.49E+10	8.52E+08	2.77E+08	3.53E+10	2.12E+08	1.10E+09	7.57E+08	5.75E+10	2.06
Pu-240	5.69E+09	1.97E+10	9.20E+08	3.87E+08	4.98E+10	2.15E+08	1.23E+09	1.08E+09	7.91E+10	2.04
Pu-241	5.95E+10	3.52E+11	1.48E+10	5.08E+09	7.88E+11	4.22E+09	2.36E+10	1.65E+10	1.26E+12	2.42
Pu-242	4.40E+07	1.03E+08	6.00E+06	2.87E+06	3.12E+08	1.29E+06	7.01E+06	5.66E+06	4.82E+08	2.38
Am-241	7.46E+10	1.98E+11	5.16E+10	6.10E+09	2.81E+14	6.08E+09	2.21E+10	3.62E+09	2.81E+14	12.1
Am-242m	9.91E+07	3.62E+08	1.49E+07	6.76E+06	8.38E+08	3.32E+06	2.07E+07	2.40E+07	1.37E+09	2.36
Am-243	2.97E+08	1.32E+09	5.67E+07	2.53E+07	3.21E+09	1.28E+07	8.02E+07	7.54E+07	5.07E+09	1.97
Cm-243	3.17E+07	2.12E+08	7.57E+06	7.98E+05	4.18E+08	2.46E+06	1.40E+07	1.16E+07	6.99E+08	2.15
Cm-244	1.48E+09	2.15E+10	5.21E+08	3.74E+07	2.64E+10	1.75E+08	1.26E+09	1.23E+09	5.26E+10	2.40
Cm-245	4.37E+06	2.00E+07	5.97E+05	2.86E+05	4.15E+07	1.28E+05	1.01E+06	1.24E+06	6.91E+07	2.44
Cm-246	1.16E+06	6.50E+06	1.59E+05	7.58E+04	1.23E+07	3.41E+04	3.27E+05	4.08E+05	2.10E+07	2.45
Total	4.61E+14	2.61E+14	7.90E+12	8.36E+12	2.17E+15	1.06E+12	1.20E+13	2.89E+13	2.95E+15	3.04

\* C-14 has been divided into organic, inorganic and induced activity.

\*\* Ratio to best estimate radionuclide inventory given in Table 4-6.

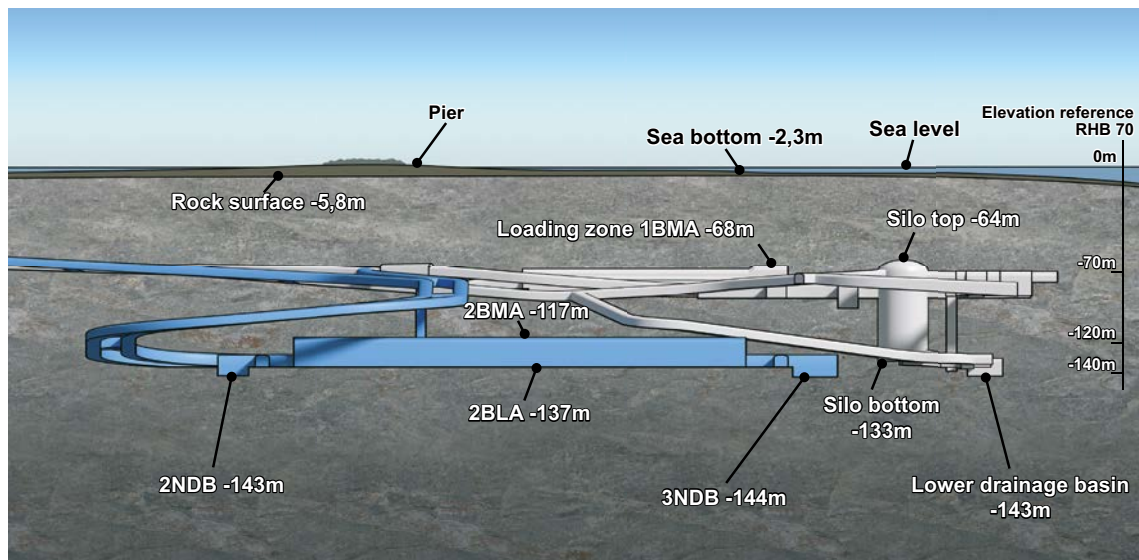
### 4.3 Repository

SFR is designed as a subsea hard rock facility that is reached via access tunnels from a surface facility. SFR 1 comprises a silo and four waste vaults for different waste categories. The waste vaults are located about 60 m beneath the surface of the sea. The bottom of the silo is located much deeper, however, about 130 m beneath the sea surface. SFR 3 is planned to contain six waste vaults. The waste vaults in the new part will be located about 120 m beneath the sea surface, which means that they will be at the level of the bottom of the silo, see Figure 4-3. The designated levels in the figure are given in RHB 70 which is the Swedish geographical height system. Today, there are two access tunnels and in order to enable whole reactor pressure vessels (RPVs) to be emplaced in the repository, a third access tunnel is planned.

The SFR facility will be decommissioned when all waste has been deposited. When the decision on final shutdown has been taken, decommissioning of the facility will begin and continue until the repository has been closed and sealed. A carefully designed decommissioning plan, centred on the closure sequence, will be drawn up in good time before the closure works begin. Demolition and dismantling of existing systems will then be coordinated with the execution of closure. After decommissioning and closure, the repository is a passive system that can be left without further measures having to be taken to maintain proper function. Facilities above ground will be decontaminated and used for other purposes or demolished.

#### **Description of repository after closure**

Closure includes installation of backfill material and plugs at selected locations in the underground facility. The primary purpose is to reduce the flow of water through the waste and impede human intrusion into the repository. Plugs are to be installed in access tunnels and connecting shafts, and all tunnels are to be backfilled with macadam<sup>6</sup>. The upper part of the access tunnels is to be filled with stone blocks and sealed with concrete plugs. Finally, the ground surface will be restored to blend in with the surrounding landscape. In addition, all boreholes at SFR will be sealed so that the water flow in the surrounding rock is not affected by them.



**Figure 4-3.** View of SFR with designated levels in RHB 70 (RHB 70 is the Swedish geographical height system). View is towards the NW, approximately perpendicular to the waste vaults. Note that stipulated elevations for the top surface of the rock and the sea floor are to be regarded as approximate since they are point data and vary in the plane above SFR. The grey part is SFR 1 and the blue part is SFR 3.

<sup>6</sup> Macadam is crushed rock sieved in fractions of 2–65 mm. Macadam has no or very little fine material (grain size < 2 mm). The fraction is given as intervals, for example “Macadam 16–32” is crushed rock comprising the fraction 16–32 mm.

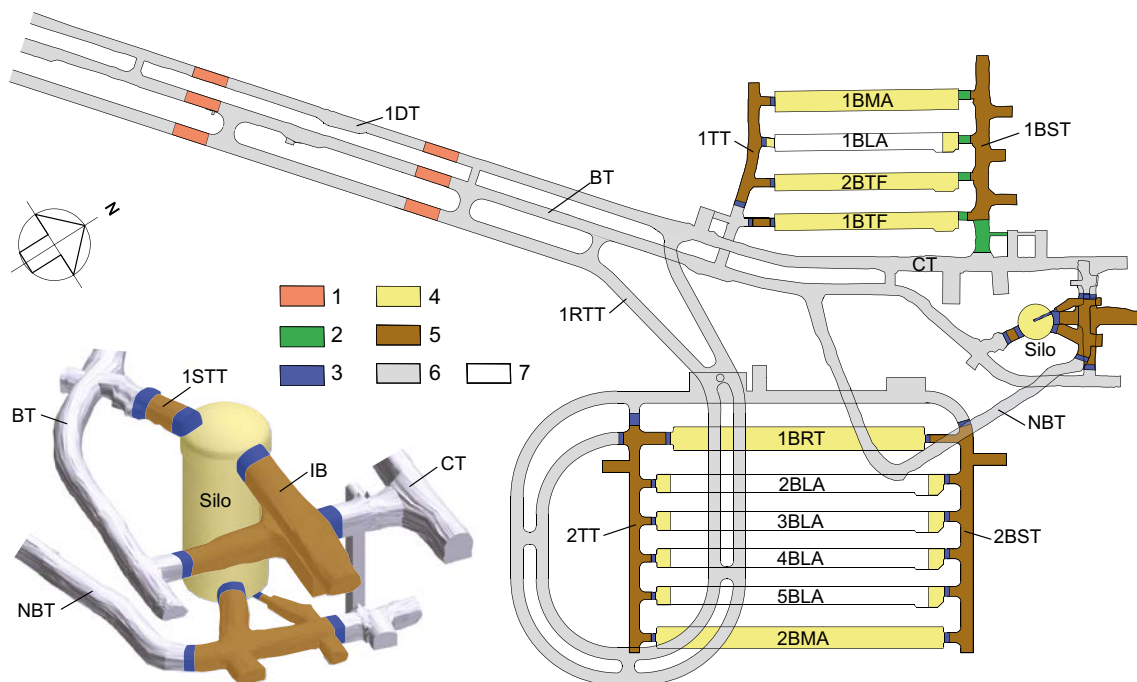
A summary description of each waste vault after closure as well as plugs and other closure components is provided in the following sections. The planned closure measures are described in greater detail in the Closure plan for SFR (SKBdoc 1358612).

It should be noted that the long-term safety assessment for SFR (SR-PSU), is based on the repository extension design defined in March 2012, Layout 1.5. However, the preparation of a licence application to build and operate a repository is an iterative, long-term process and changes have been made to the extension design in the time taken to compile the long-term safety assessment. Therefore, all parts of the application for the extension of SFR, except the long-term safety assessment, are based on the amended design, Layout 2.0. It is therefore important to state the main differences between the two designs explicitly, which are:

- length of BRT,
- height and width of 2BMA.

However in the description given here, all figures are according to Layout 2.0 and dimensions are given for both layouts where they differ.

An overall picture of the closed repository is shown in Figure 4-4. The plug sections are hydraulically tight sections with bentonite that is held in place by mechanical constraints. Wherever warranted by the geometry of the tunnels and the properties of the rock, concrete plugs are installed as mechanical constraints. Where this is not suitable, a mechanical constraint consisting of backfill and transition material is installed instead. The role of the transition material is to hinder bentonite transport out from the hydraulically tight section, to take up the load from bentonite swelling and transfer it to the backfill material. The backfill material consists of macadam and the transition material of 30/70 bentonite/crushed rock. A mechanical constraint of backfill and transition material together with a tight section of bentonite is called an earth dam plug.



**Figure 4-4.** Schematic plan of SFR 1 and SFR 3, with a detailed view of the silo. Key to numbering: 1) Plugs in access tunnels 2) Transition material 3) Mechanical plug of concrete 4) Backfill material of macadam 5) Hydraulically tight section of bentonite 6) Backfill material in access tunnels and the central area of the tunnel system 7) Non-backfilled openings. Note that the figure shows Layout 2.0; Layout 1.5 is used in SR-PSU modelling. The only difference relevant to this figure is that BRT is longer here than in Layout 1.5. The labels in the figure are referred to in the text.

### 4.3.1 1BMA, vault for intermediate-level waste

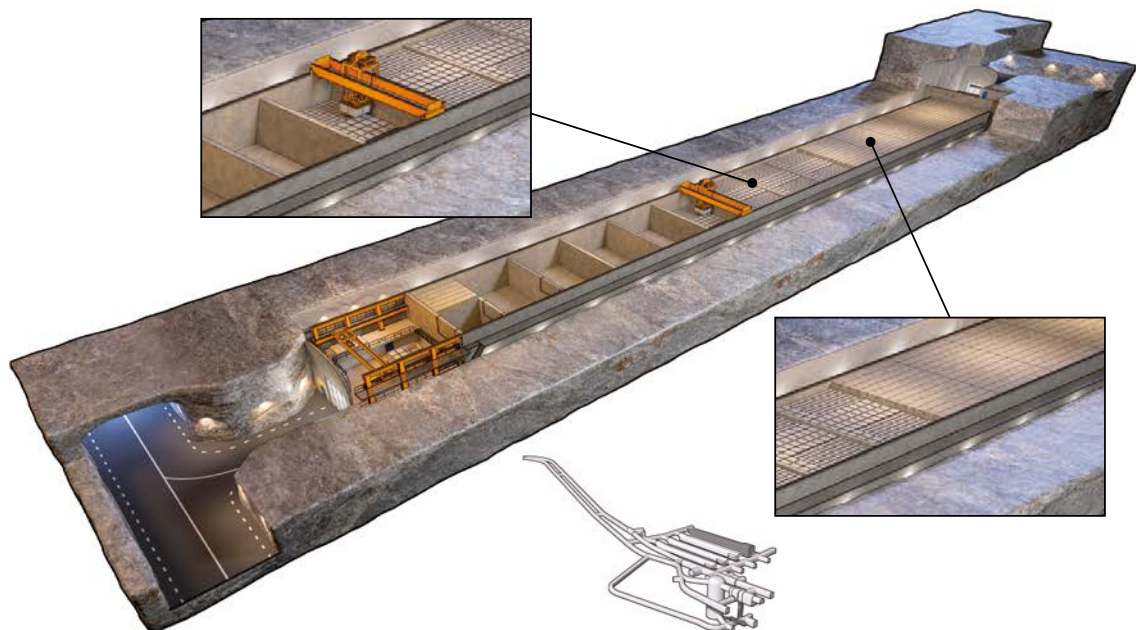
The waste vault is approximately 20 m wide, 17 m high and 160 m long. The waste is deposited in an approximately 140 m long reinforced concrete structure divided into 13 large compartments and two smaller compartments. The load-bearing parts of the concrete structure are founded on solid rock and the floor on a base of crushed rock levelled with gravel. The floor and walls structures are made of *in-situ* cast reinforced concrete. To keep the forms in place during casting penetrating form rods made out of steel were used. The walls and roof in the vault are lined with shotcrete.

In the compartments, concrete and steel moulds, as well as steel drums (on a drum tray or in a drum box) are deposited by a remote-controlled overhead crane that runs on the top edge of the walls of the concrete structure, see Figure 4-5. The waste is deposited as it arrives at SFR; moulds are stacked six high and drums eight high. As the compartments are filled, they are temporarily closed with thick radiation-shielding prefabricated concrete elements. At least two rows of concrete moulds are installed in each compartment to support the prefabricated concrete elements.

#### **Description of the vault after closure**

An extensive programme for investigation of the concrete structure has been carried out and has revealed that extensive repair and reinforcement measures need to be adopted to achieve the desired hydraulic and mechanical properties at closure. The Closure plan for SFR (SKBdoc 1358612) describes the planned measures for closure of 1BMA.

Prior to closure and after operations have been concluded, the waste packages in the compartments are embedded in grout and a reinforced concrete lid is cast on top of the prefabricated concrete elements. Installations and equipment in the vault are removed and the space between the concrete structure and the rock wall is backfilled with macadam, see Figure 4-6. At the end of the waste vault that connects to the transverse tunnel (1TT), a concrete plug is installed as a mechanical constraint for the bentonite in the tunnel. It is not possible to install a concrete plug in the connection to the waste vault tunnel (1BST); instead, here the mechanical constraint for the bentonite consists of a section with transition material and backfill material in the waste vault, see Figure 4-4 and Figure 4-7.



**Figure 4-5.** Vault for intermediate-level waste, 1BMA, in SFR 1 during the operational phase.

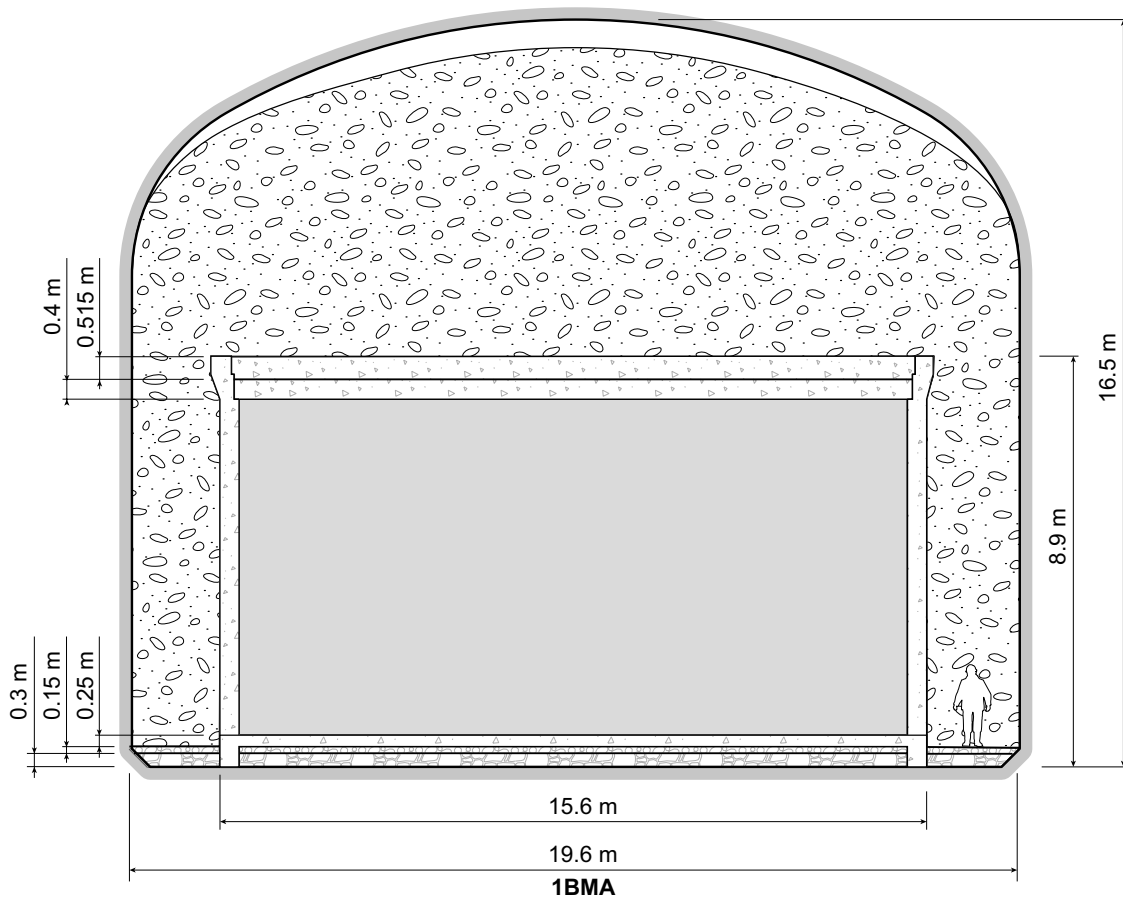


Figure 4-6. Schematic cross-section of 1BMA after closure.

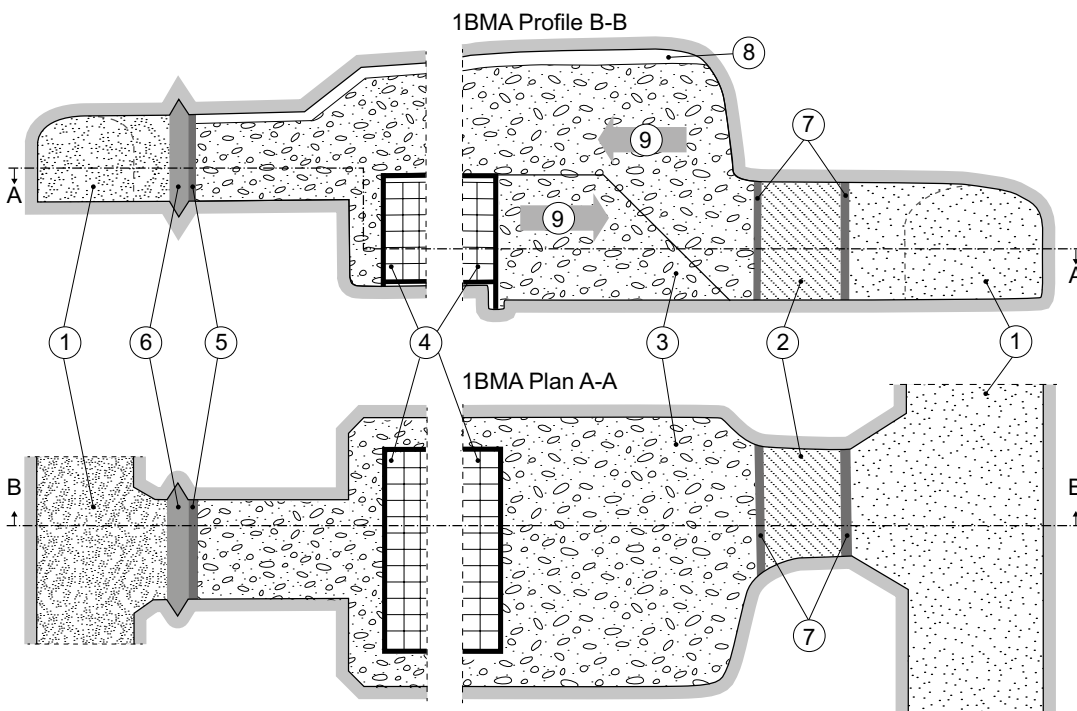


Figure 4-7. Schematic profile and plan of 1BMA after closure. Key to numbering: 1) Bentonite 2) Transition material, e.g. 30/70 mixture of bentonite and crushed rock 3) Macadam 4) Grouted waste packages 5) Constraining wall and concrete form 6) Mechanical plug of concrete 7) Constraining wall of concrete for transition material 8) Open gap between top surface of macadam and tunnel roof 9) Working direction for backfilling of waste vault.



### **Condition of the system components**

The conditioned waste is surrounded by the following components:

- Waste packaging.
- Grout in compartments.
- Concrete structure, i.e. reinforced concrete compartment walls and bottom, plus prefabricated concrete elements and overcast concrete lid.
- Backfill of macadam.
- Mechanical plugs (see Section 4.3.8).

The waste packaging in 1BMA is made of concrete or steel plate. Steel waste packages will probably start to corrode during the operational phase. The possibility cannot be ruled out that small fractures, more than 0.1 mm wide, will form in concrete waste packaging during the operational phase or even initially. Steel reinforcement (rebar) in the concrete structure will corrode during the operational phase.

Other components that are emplaced prior to closure are expected to be in the condition the items had at the time of emplacement i.e. only minor changes during the operational phase.

In order to achieve good condition for the concrete structure, measures are planned to repair it prior to closure (SKBdoc 1358612).

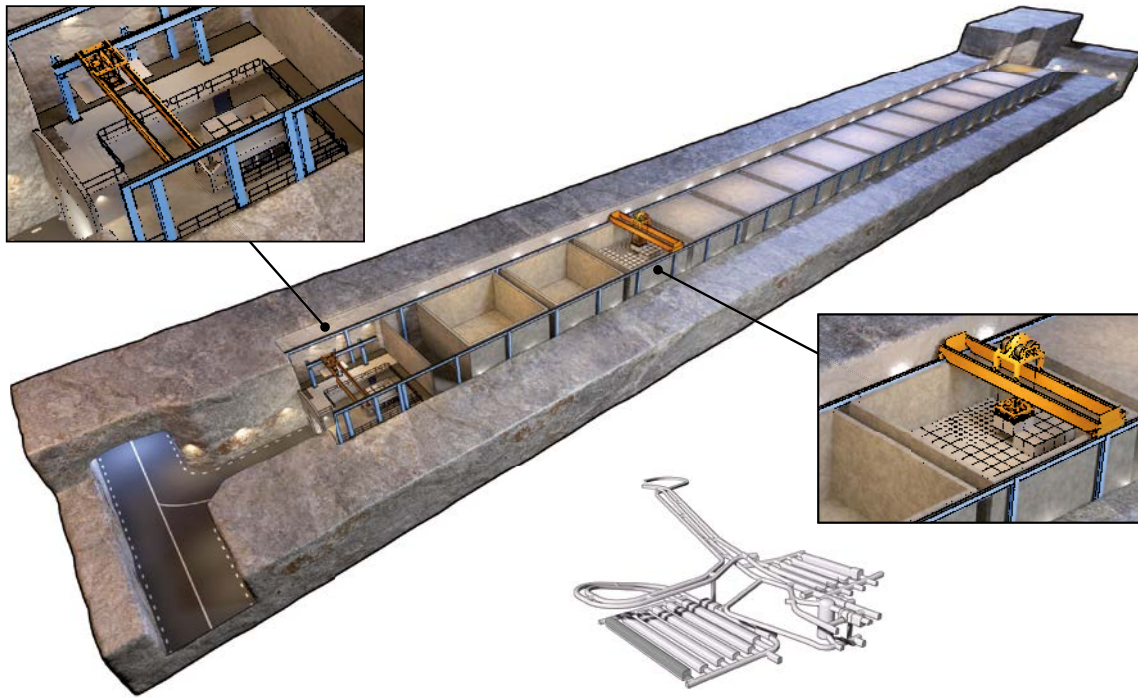
### **4.3.2 2BMA, vault for intermediate-level waste**

SFR 3 includes an approximately 20 m wide, 16 m high (16.8 m in Layout 1.5) and 275 m long vault for intermediate-level waste. Experience from 1BMA has been utilised in the design of the disposal room in 2BMA. 14 free-standing unreinforced concrete caissons with a base of 16×16 m and a height of more than 8 m are to be built in the waste vault. The concrete caissons will be founded on a base of crushed rock levelled with gravel, and the walls and roof will be lined with shotcrete.

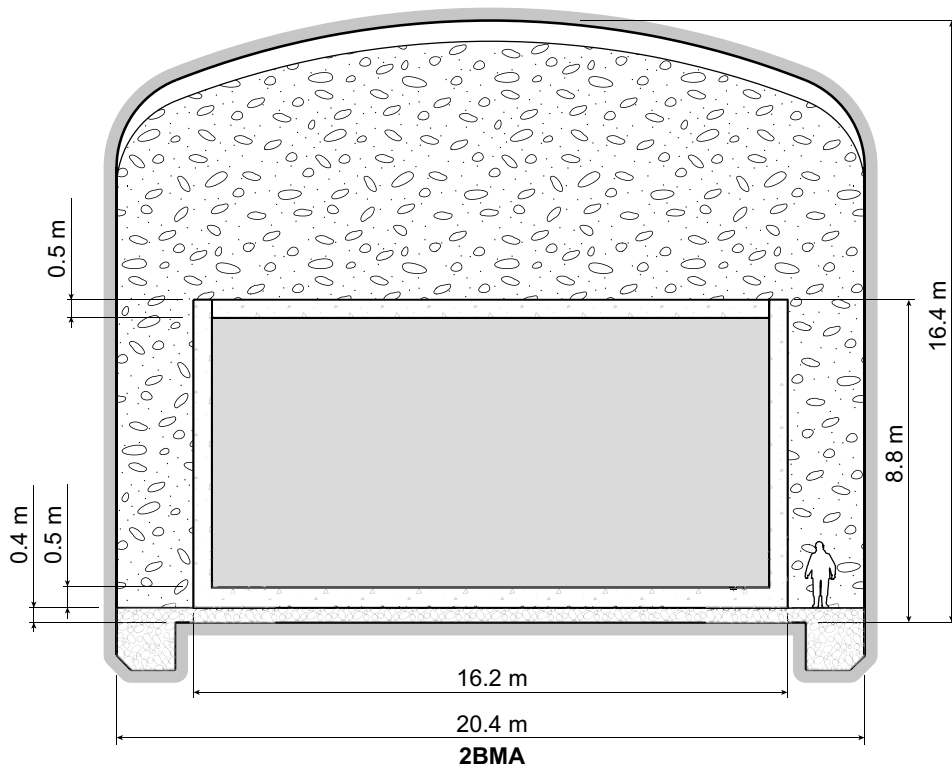
Waste packages in the form of steel and concrete moulds will be deposited in each caisson by a remote-controlled overhead crane. The overhead crane is installed on a free-standing column system and does not rest on the caissons, see Figure 4-8. Grouting of the waste packages will be done continuously during operation. The size of the caissons ensures sufficient spacing between each 4-mould unit for the embedment grout. This also ensures that the grout will make a contribution to the total load-bearing capacity of the caissons. If needed, prefabricated concrete elements will be placed on top of the caissons to serve as radiation shielding during the operational phase.

### **Description of the vault after closure**

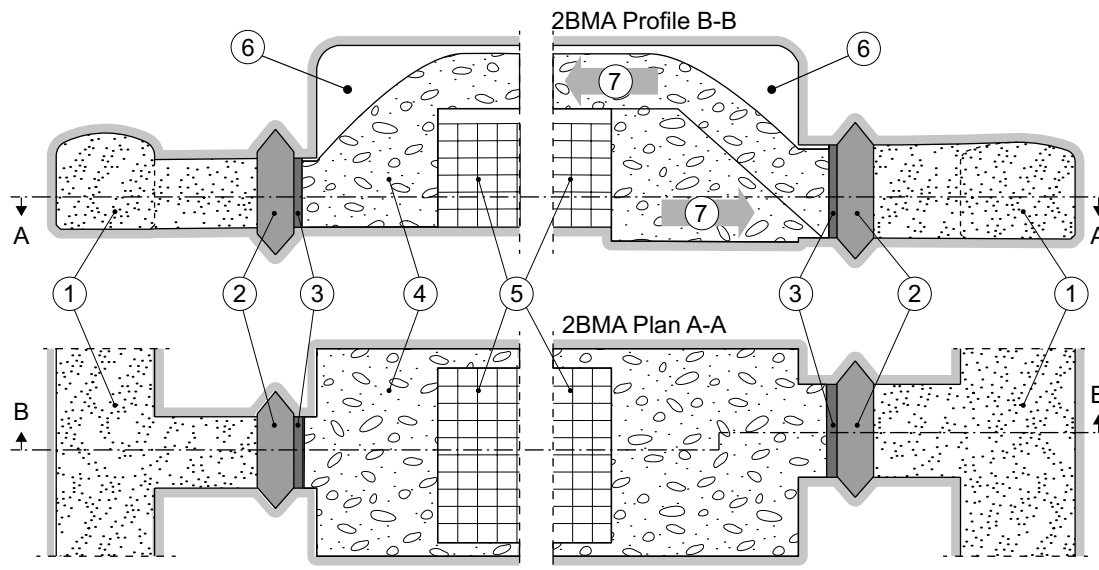
The Closure plan for SFR (SKBdoc 1358612) describes the planned measures for closure of 2BMA. The prefabricated concrete elements are removed prior to closure and instead an unreinforced concrete lid is cast on top of the grout-embedded waste in the caisson. The casting joint formed between walls and lid in the caisson due to shrinkage of the concrete will act as a pathway for gas formed due to corrosion of metals in the waste packages. Installations and equipment in the waste vault are removed and the space between caissons, as well as between caissons and the rock wall, is backfilled with macadam, see Figure 4-9. The geometry of the waste vault is such that concrete plugs can be installed at both ends of the waste vault as mechanical constraints for the bentonite in connecting tunnels, see Figure 4-10.



**Figure 4-8.** Vault for intermediate-level waste, 2BMA, in SFR 3 during the operational phase.



**Figure 4-9.** Schematic cross-section of 2BMA after closure. Note that the figure shows Layout 2.0; Layout 1.5 is used in SR-PSU modelling. The concrete structure has the same dimensions in Layout 1.5, but the width of the vault is 19.8 m and the height is 16.8 m.



**Figure 4-10.** Schematic profile and plan of 2BMA after closure. Key to numbering: 1) Bentonite 2) Mechanical plug of concrete 3) Constraining wall and concrete form 4) Macadam 5) Grouted waste packages 6) Open gap between top surface of macadam and tunnel roof 7) Working direction for backfilling of waste vault.

#### **Condition of the system components**

The conditioned waste is surrounded by the following components:

- Waste packaging.
- Grout in caissons.
- Walls and bottom of caissons of unreinforced concrete.
- Lids on caissons of unreinforced concrete.
- Backfill of macadam.
- Mechanical plugs (see Section 4.3.8).

The waste packages in 2BMA are continuously grouted during the operational phase. This means that the condition of the waste packages cannot be inspected afterwards. Steel waste packaging will probably start to corrode during the operational phase. The possibility cannot be ruled out that small fractures, more than 0.1 mm wide, will form in concrete waste packaging during the operational phase or even initially.

Other components that are emplaced prior to closure are expected to be in the condition the items had at the time of emplacement i.e. only minor changes during the operational phase.

#### **4.3.3 1BTF and 2BTF, vaults for concrete tanks**

The two waste vaults 1BTF and 2BTF are approximately 15 m wide, 9.5 m high and 160 m long. The vaults are primarily designed for disposal of dewatered ion-exchange resins in concrete tanks. The walls and roof of the vaults are lined with shotcrete. The concrete floors are cast on a draining foundation and surrounded by a 1 m high baseboard along the rock wall. To facilitate the planned grouting of the concrete tanks, a number of concrete pillars are cast on the baseboard; see the illustration at the bottom of Figure 4-11 and Figure 4-12.

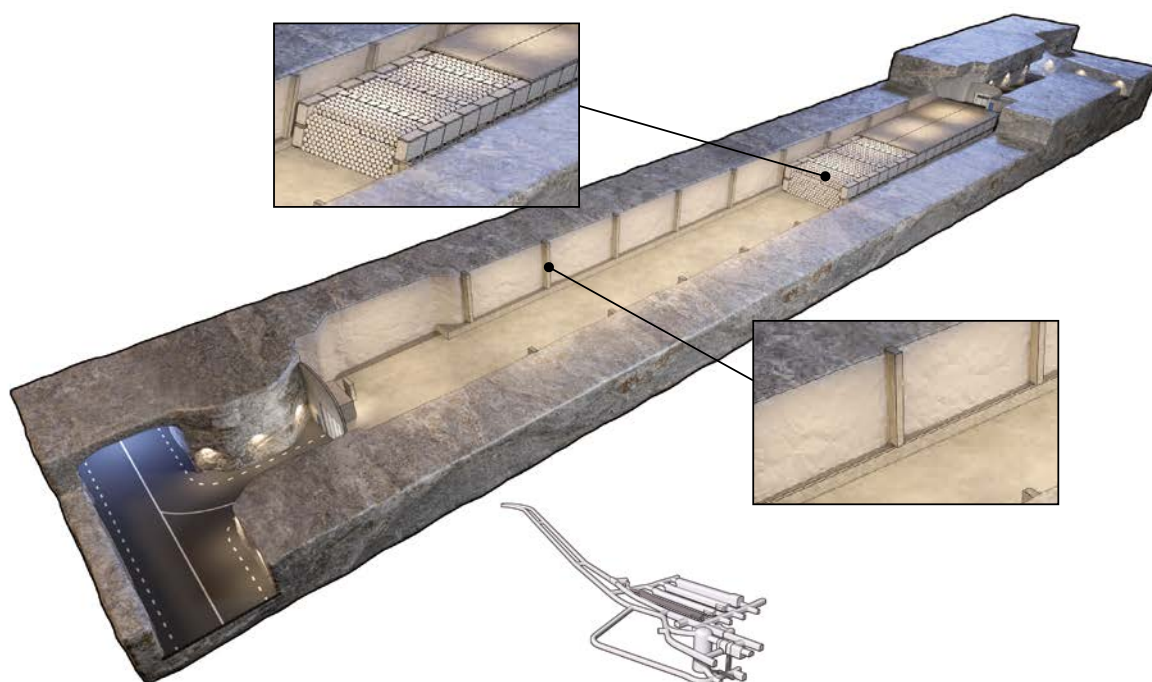
Besides concrete tanks, drums containing ashes from incineration at Studsvik as well as miscellaneous types of waste such as a reactor pressure vessel head are also deposited in 1BTF. To provide support for the drums with ashes in 1BTF, concrete tanks are positioned in the tunnel direction and partition walls are built up of concrete moulds with low activity content and low surface dose rate; see the illustration at the top of Figure 4-11. Grouting of ash drums is done progressively during operations.

Only concrete tanks are placed in 2BTF. The tanks are positioned four abreast and two in height, after which prefabricated concrete elements are placed on top as radiation shielding, see Figure 4-12.

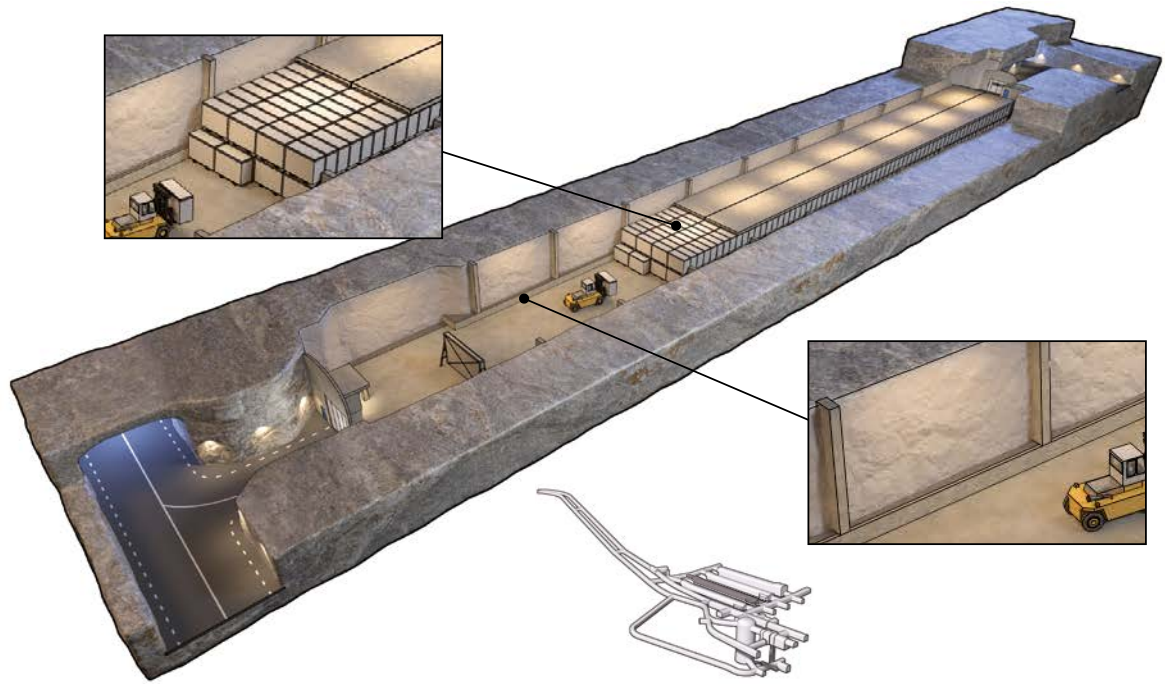
### **Description of the vault after closure**

The Closure plan for SFR (SKBdoc 1358612) describes the planned measures for closure of 1BTF and 2BTF. The space between concrete tanks and rock wall is filled with grout as the first step in closure of the waste vaults. In 2BTF with only concrete tanks, the spaces between the concrete tanks are filled with grout in the next step, and on top of the prefabricated concrete elements a concrete slab is cast to bear the weight of the macadam. In 1BTF, the ash drums in the inner half of the waste vault are already grouted, and the outer half with only concrete tanks is grouted in the same way as in 2BTF. Finally, the space above the grout and the concrete slab is filled with macadam up to the roof and the waste vaults are plugged in the same way as 1BMA, see Section 4.2.2.

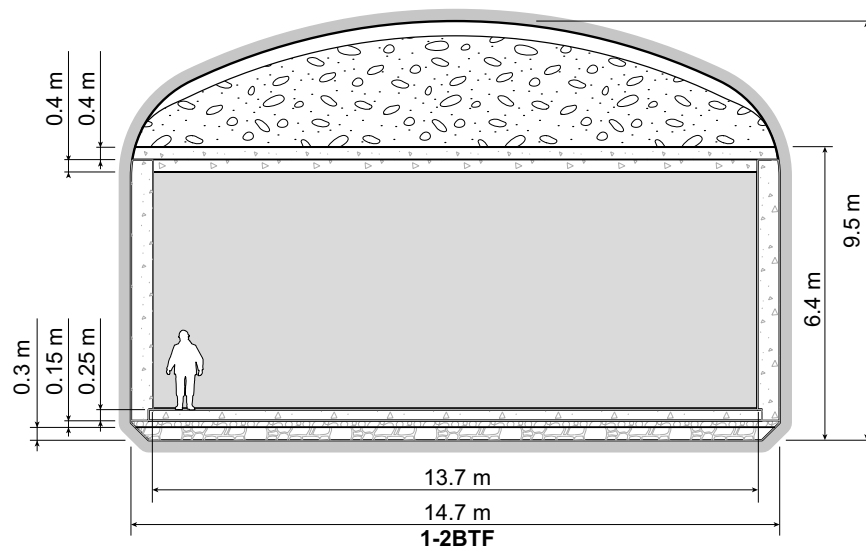
Figure 4-13 and Figure 4-14 show schematic illustrations of 1BTF and 2BTF after closure. The aim with the new rock profile (10 in Figure 4-14) is to increase the contact area between the macadam and the rock and thereby increase the mechanical support for the transition material in the plug.



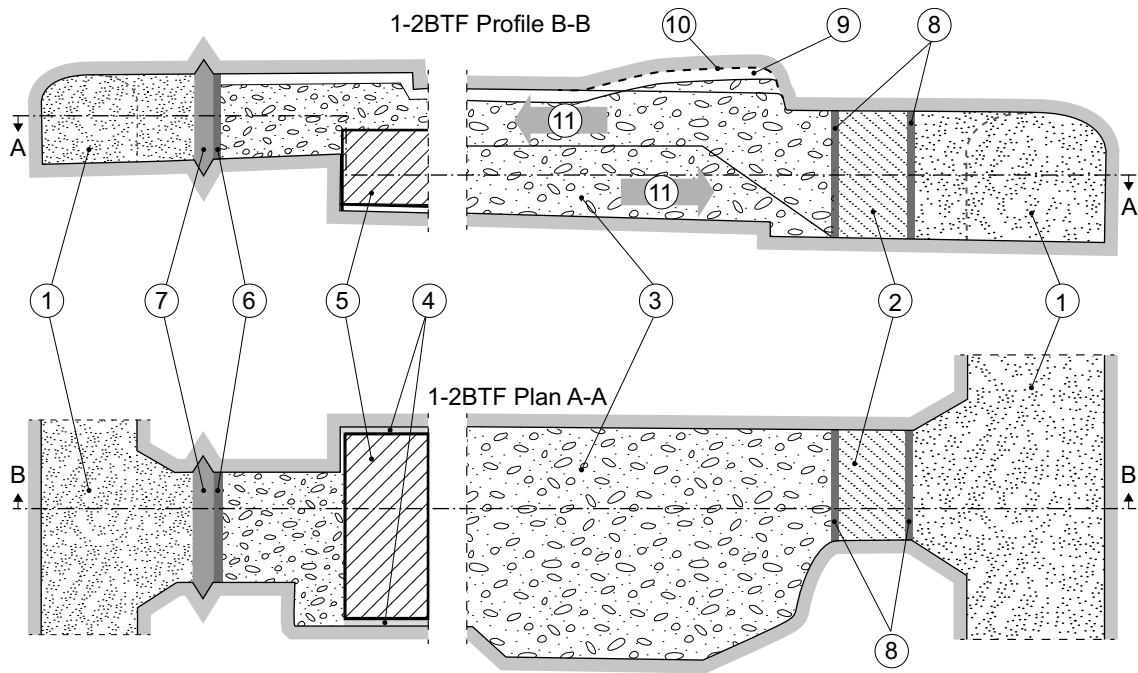
**Figure 4-11.** Vault for concrete tanks, 1BTF, in SFR 1 during the operational phase. The top part illustrates emplacement of ash drums.



**Figure 4-12.** Vault for concrete tanks, 2BTF, in SFR 1 during the operational phase. The top part illustrates the emplacement of concrete tanks.



**Figure 4-13.** Schematic cross-section of 1BTF and 2BTF after closure.



**Figure 4-14.** Schematic profile and plan of 1BTf and 2BTf after closure. Key to numbering: 1) Bentonite 2) Transition material 3) Macadam 4) Concrete between waste and rock wall 5) Grouted waste packages 6) Constraining wall and concrete form 7) Mechanical plug of concrete 8) Constraining wall of concrete for transition material 9) Open gap between top surface of macadam and tunnel roof 10) New rock profile 11) Working direction for backfilling of waste vault.

#### **Condition of the system components in 1BTf**

The waste is surrounded by the following components:

- Waste packaging.
- Moulds and concrete tanks positioned as support walls for drums.
- Grout (space between waste packages and space between concrete tanks and rock wall).
- Concrete floor.
- Prefabricated concrete elements and overcast concrete lid.
- Backfill of macadam.
- Mechanical plugs (see Section 4.3.8).

The waste packages (drums with ashes) in 1BTf are embedded in grout as they are placed. This means that the condition of the waste packages cannot be inspected afterwards. Steel waste packaging will probably start to corrode during the operational phase. The possibility cannot be ruled out that small fractures will form in concrete tanks and moulds during the operational phase or even initially.

Other components that are placed prior to closure are expected to be in the condition they had at the time of placement i.e. only minor changes during the operational phase.

#### **Condition of the system components in 2BTf**

The waste is surrounded by the following components:

- Waste packaging (concrete tank lined with butyl rubber).
- Grout (space between waste packages and space between concrete tanks and rock wall).
- Concrete floor.

- Prefabricated concrete elements and overcast concrete lid.
- Backfill of macadam.
- Mechanical plugs (see Section 4.3.8).

The possibility cannot be ruled out that small fractures will form in the concrete tanks during the operational phase or even initially.

Other components that are emplaced prior to closure are expected to be in the condition the items had at the time of emplacement i.e. only minor changes during the operational phase.

#### 4.3.4 Silo

The silo is a cylindrical vault in which a free-standing concrete cylinder has been built. The silo vault is about 70 m high with a diameter of about 30 m. The concrete cylinder is made of *in-situ* cast concrete and the concrete bottom is founded on a bed of 90% sand and 10% bentonite. The concrete cylinder is divided into a number of vertical shafts, and the gap between the concrete cylinder and the rock is filled with bentonite. The bentonite is a bentonite from Milos (Greece) converted from its original Ca-form to the Na-state by soda treatment. The material composition of the bentonite is given in the **Initial state report**. The rock walls are lined with shotcrete, and a rock drainage system is installed between the bentonite and the rock.

Conditioned intermediate-level waste is deposited in the silo in concrete and steel moulds as well as in steel drums (on a drum tray or in a steel box), see Figure 4-15. Grouting of waste packages in the shafts is done progressively. During operations, each shaft is provided with a radiation-shielding lid that is removed at closure.



**Figure 4-15.** Illustration of the silo during the operational phase.

### Description of the vault after closure

The Closure plan for SFR (SKBdoc 1358612) describes the planned measures for closure of the silo. In an initial step, the shafts are overcast with cement grout up to the top rim of the concrete silo. This provides a radiation shield on top of the concrete silo, which simplifies the work of reinforcing and casting a concrete lid. The concrete lid is cast on a thin layer of sand and provided with gas venting in the form of pipes filled with sand that penetrate the lid, see Figure 4-16.

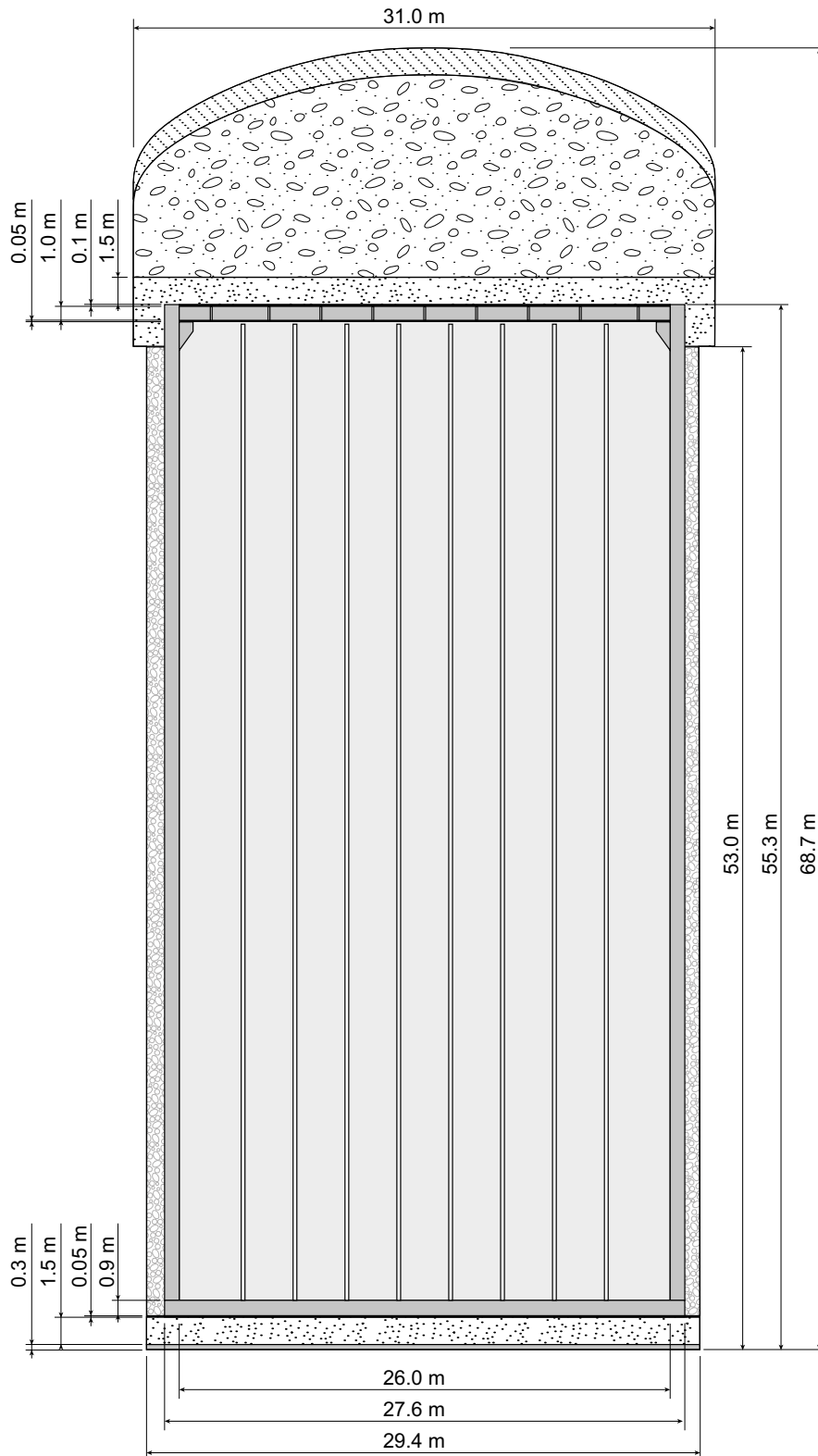


Figure 4-16. Schematic cross-section of the silo after closure.



The top bentonite layer in the gap between rock and concrete silo may have been affected during the operational phase and is replaced with new bentonite. The silo top above the concrete lid is backfilled with different layers of backfill material. The backfill materials intended to be used in the silo top are shown in Figure 4-17. A mixture of sand and bentonite is placed on top of a thin layer of sand and protected by a thin unreinforced concrete slab. The space above it is filled with friction material e.g. crushed rock or macadam and, at the very top, with cement-stabilised sand.

Finally, a plug is installed at the bottom of the silo and two at the top to seal the silo, see Section 4.3.8.

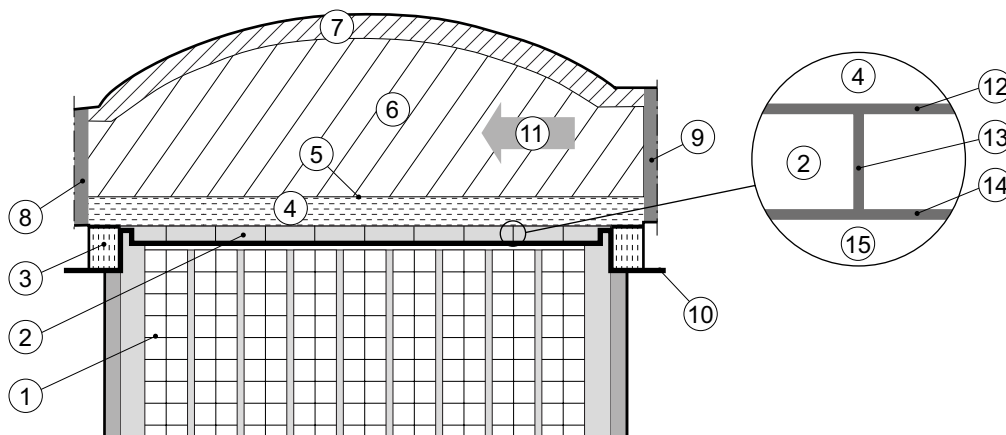
### **Condition of the system components**

The conditioned waste is surrounded by the following components:

- Waste packaging.
- Grout.
- Shaft walls.
- Concrete structure of the silo.
- Bentonite or sand/bentonite buffer.
- Backfill material in the silo top.
- Mechanical plugs (see Section 4.3.8).

The waste packages in the silo are embedded in grout as they are emplaced. This means that the condition of the waste packages cannot be inspected afterwards. Steel waste packaging will probably start to corrode during the operational phase. The possibility cannot be ruled out that small fractures will form in concrete waste packaging during the operational phase or even initially.

Other components that are emplaced prior to closure are expected to be in the condition the items had at the time of emplacement i.e. only minor changes during the operational phase.



**Figure 4-17.** Schematic cross-section of silo top after closure. Key to numbering: 1) Waste 2) Reinforced concrete slab with sand layer and gas evacuation pipes 3) Compacted fill of 30/70 bentonite/sand mixture 4) Compacted fill of 10/90 bentonite/sand mixture 5) Unreinforced concrete slab 6) Compacted fill of friction material 7) Cement-stabilised sand 8) Constraining wall of concrete against silo roof tunnel (ISTT) 9) Constraining wall of concrete against loading-in building (IB) 10) Boundary between works associated with grouting and backfilling 11) Working direction for backfilling with material described in (6) and (7) 12) Sand layer 100 mm 13) Gas evacuation pipe Ø 0.1 m 14) Sand layer 50 mm 15) Grout (permeable).

### 4.3.5 1BLA, vault for low-level waste

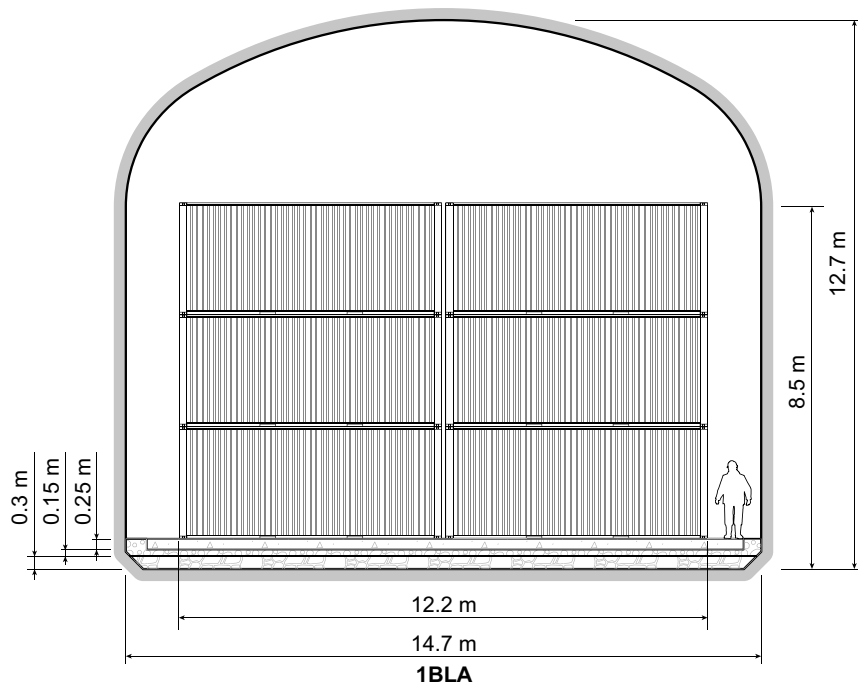
Waste in ISO containers is deposited in the vault for low-level waste. The vault is about 15 m wide, 13 m high and 160 m long. The containers are handled by forklift and stacked two abreast and three to six in height, depending on their size, see Figure 4-18. The vault has a concrete floor cast on a draining foundation, and the rock walls and roof are lined with shotcrete.

#### **Description of the vault after closure**

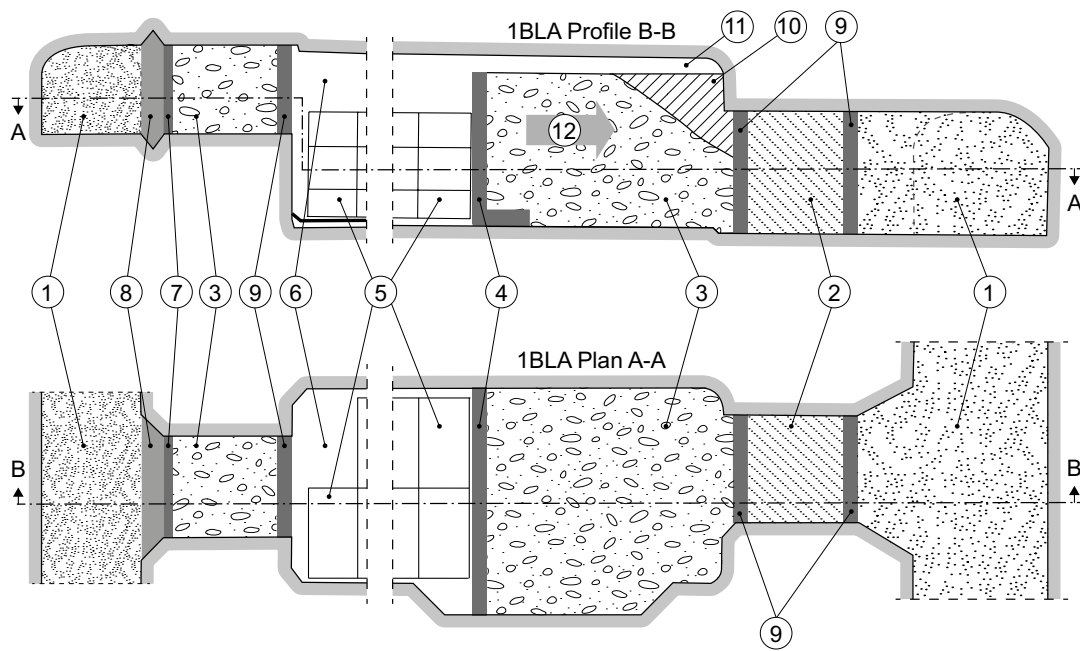
The Closure plan for SFR (SKBdoc 1358612) describes the planned measures for closure of 1BLA. A concrete wall is installed at the end towards the transverse tunnel (1TT) and approximately 4 m is backfilled with macadam, after which a concrete plug is cast. A mechanical constraint consisting of backfill material is needed at the end towards the waste vault tunnel (1BST) to hold the transition material in the earth dam plug in place, see Figure 4-4. The constraint is made by backfilling 10 m of the waste vault with macadam against a retaining wall and filling the space above the backfill and above the level of the connecting tunnel with concrete. The space around and above the containers will not be backfilled, as backfilling is used to protect concrete structures from rock fallout. Also backfilling may damage the ISO containers. Figure 4-19 and Figure 4-20 show schematic illustrations of 1BLA after closure.



*Figure 4-18. Vault for low-level waste, 1BLA, in SFR 1 during the operational phase.*



**Figure 4-19.** Schematic cross-section of 1BLA after closure.



**Figure 4-20.** Schematic profile and plan of 1BLA after closure. Key to numbering: 1) Bentonite 2) Transition material 3) Macadam 4) Retaining wall 5) Waste 6) Open waste vault 7) Constraining wall and concrete form 8) Mechanical plug of concrete 9) Constraining wall of concrete for transition material 10) Concrete 11) Gap at roof 12) Working direction for backfilling of waste vault.

### **Condition of the system components**

The waste is surrounded by the following components:

- Waste packaging (ISO containers).
- Concrete floor.
- Mechanical plugs (see Section 4.3.8).

Steel waste packaging will corrode during the repository's operational phase.

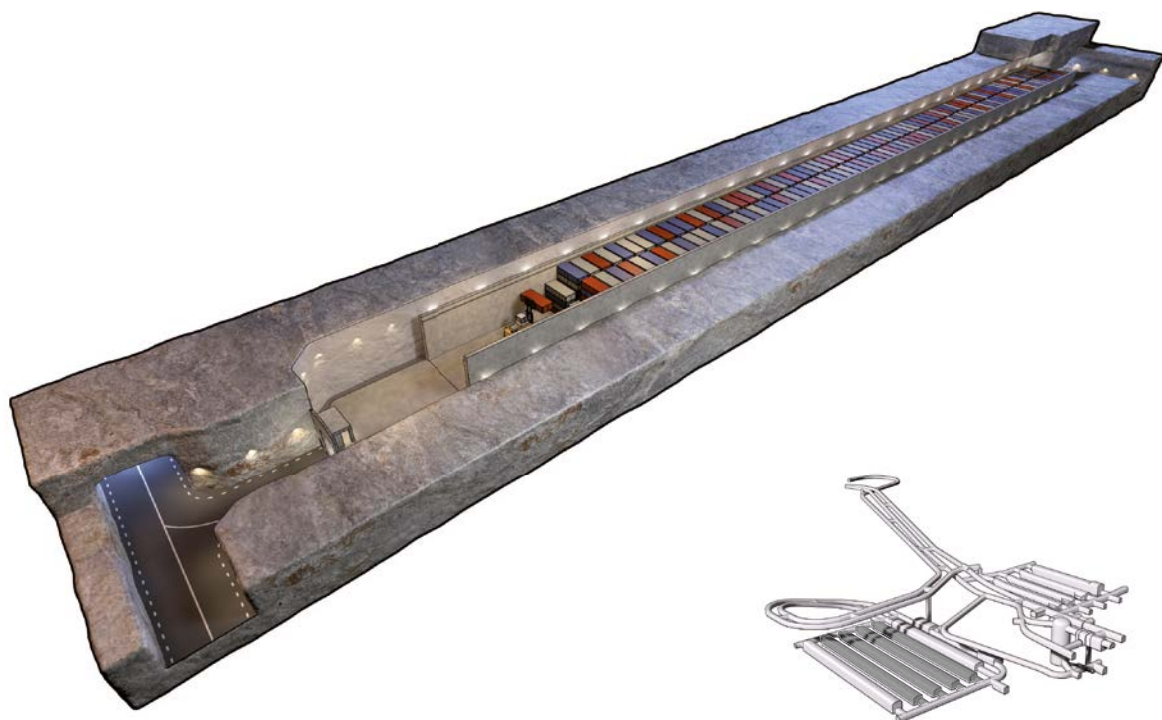
Other components that are emplaced prior to closure are expected to be in the condition the items had at the time of emplacement i.e. only minor changes during the operational phase.

### **4.3.6 2–5BLA, vaults for low-level waste**

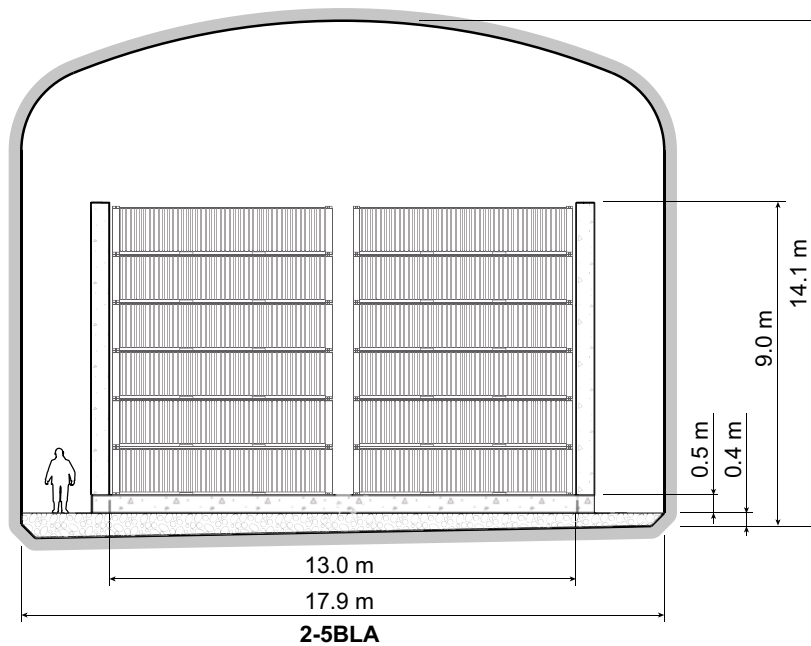
Four vaults for low-level waste will be built in SFR 3. The vaults are approximately 18 m wide, 14 m high and 275 m long. The waste will be deposited in ISO containers and stacked (assuming 20-foot half-height containers) two abreast and six in height inside the longitudinal walls. The primary function of the walls is to ensure the stability of the containers and permit access above the containers, see Figure 4-21. The vault has a concrete floor on top of a draining foundation, and the rock walls and roof are to be lined with shotcrete.

### **Description of the vault after closure**

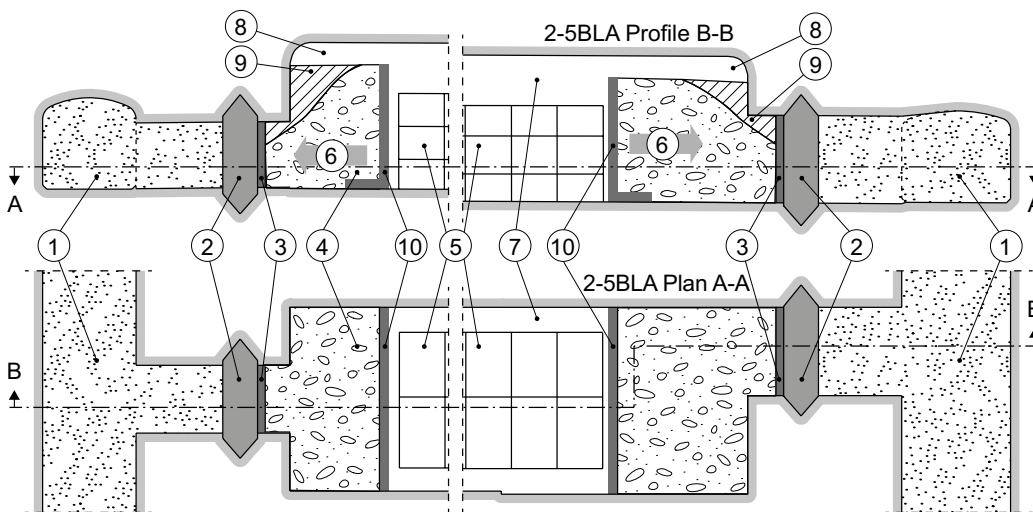
The planned measures at closure of the 2–5BLA vaults are described in the Closure plan for SFR (SKBdoc 1358612). Concrete plugs are to be installed at the ends towards the waste vault tunnel (2BST) and the transverse tunnel (2TT) along with mechanical constraints intended to serve as support when the concrete plugs are no longer intact. The constraint is made by backfilling 10 m of the waste vault with macadam against a retaining wall and filling the space above the backfill and above the level of the connecting tunnel with concrete. At repository closure, the space around and above the containers will not be backfilled, as backfilling is used to protect concrete structures from rock fall-out. Also backfilling may damage the ISO containers. Figure 4-22 and Figure 4-23 show schematic illustrations of 2–5BLA after closure.



**Figure 4-21.** Vault for low-level waste, 2–5BLA, in SFR 3 during the operational phase.



**Figure 4-22.** Schematic cross-section of 2-5BLA after closure. Note that the figure shows Layout 2.0; Layout 1.5 is used in SR-PSU modelling. The difference is that the concrete walls are 0.5 m higher in Layout 1.5.



**Figure 4-23.** Schematic profile and plan of 2-5BLA after closure. Key to numbering: 1) Bentonite 2) Mechanical plug of concrete 3) Constraining wall and concrete form 4) Macadam 5) Waste 6) Working direction for backfilling of waste vault 7) Open vault 8) Gap at roof 9) Concrete 10) Retaining wall.

### Condition of the system components

The waste is surrounded by the following components:

- Waste packaging (ISO containers).
- Concrete floor.
- Mechanical plugs (see Section 4.3.8).

Steel waste packaging will probably start to corrode during the operational phase.

Other components that are emplaced prior to closure are expected to be in the condition the items had at the time of emplacement i.e. only minor changes during the operational phase.

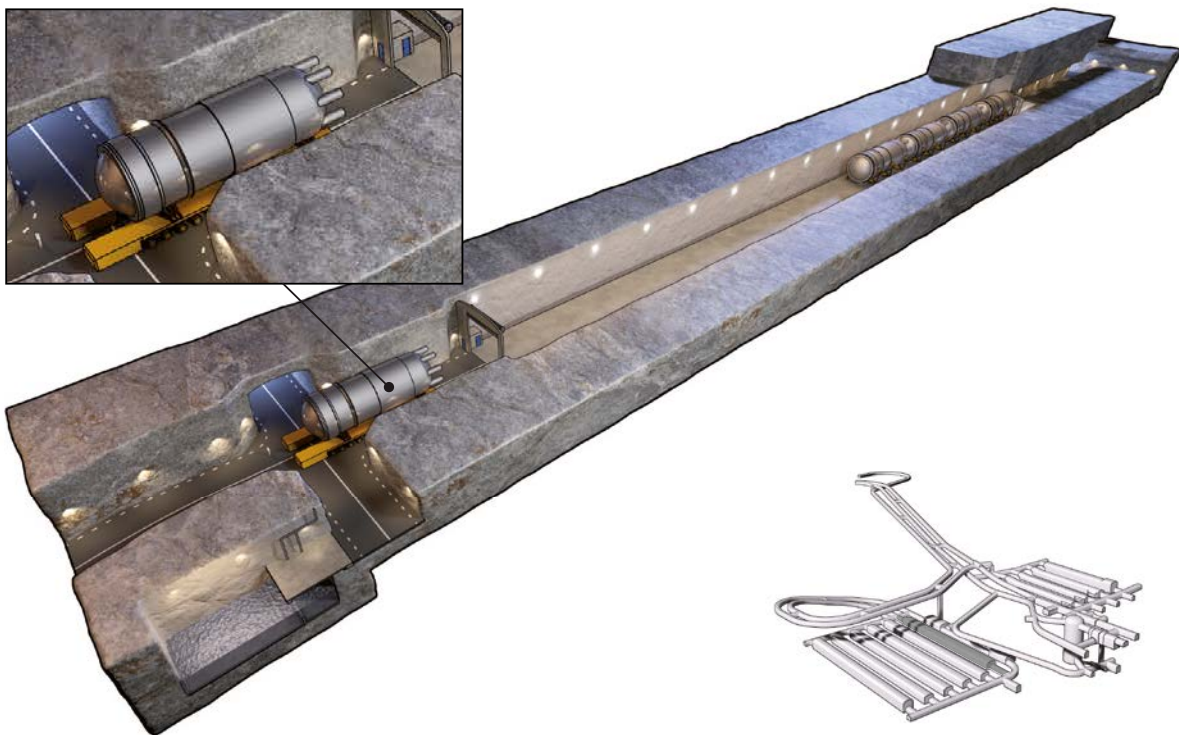
### 4.3.7 BRT, vault for reactor pressure vessels

A vault for whole reactor pressure vessels (RPVs) from boiling water reactors (BWRs) will be built in SFR 3. A total of nine RPVs are to be placed end-to-end in BRT. The vault is about 15 m wide, 13 m high and 240 m long (210 m in Layout 1.5). The walls and roof of the vault are to be lined with shotcrete, and special concrete fundamentals are to be installed on the concrete floor to hold the RPVs, see Figure 4-24.

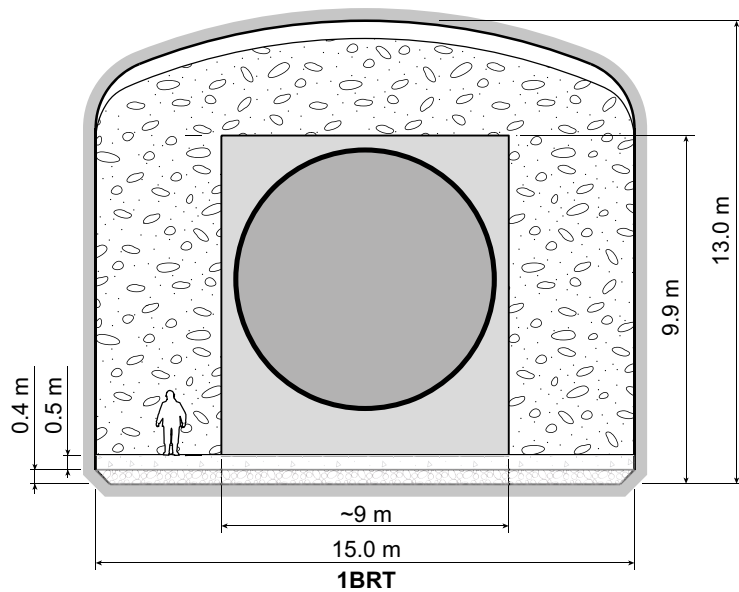
#### **Description of the vault after closure**

The planned measures at closure of BRT are described in the Closure plan for SFR (SKBdoc 1358612). At closure of the vault, the RPVs will be embedded in grout to ensure a low corrosion rate. In addition, each individual RPV will be filled with concrete or cementitious grout to both reduce the corrosion rate and minimise the risk of collapse, floating-up during embedment grouting and release of any loose contamination remaining after decontamination.

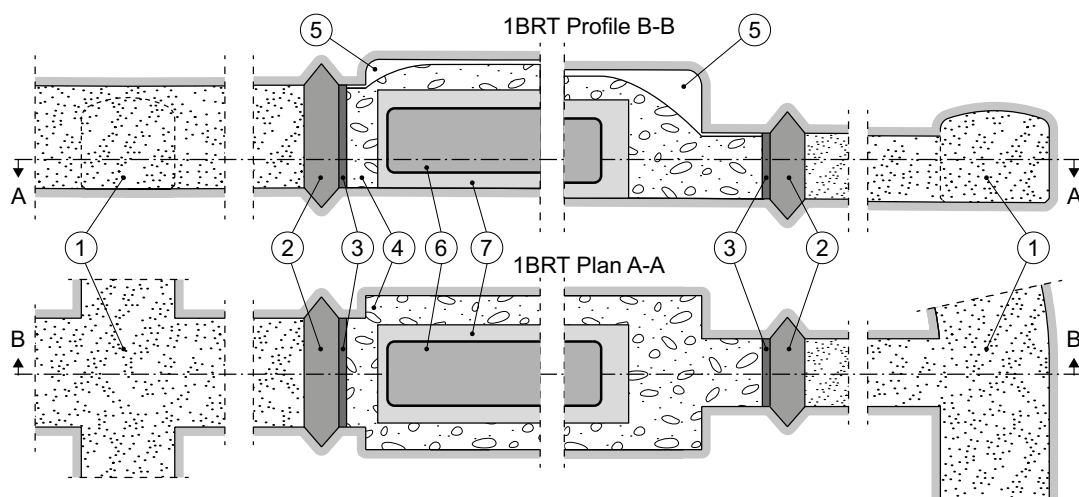
The space around the embedded RPVs is to be backfilled with macadam and concrete plugs are to be installed at the ends towards the waste vault tunnel (2BST) and the transverse tunnel (2TT), see Figure 4-4. Figure 4-25 and Figure 4-26 show schematic illustrations of BRT after closure.



*Figure 4-24. Vault for reactor pressure vessels, BRT, in SFR 3 during the operational phase.*



**Figure 4-25.** Schematic cross-section of BRT after closure. Note that the figure shows Layout 2.0; Layout 1.5 is used in SR-PSU modelling. The difference is that the height is 12.9 m in Layout 1.5.



**Figure 4-26.** Schematic profile and plan of BRT after closure. Key to numbering: 1) Bentonite 2) Mechanical plug of concrete 3) Constraining wall and concrete form 4) Macadam 5) Gap between top surface of macadam and tunnel roof 6) Grout-filled RPVs 7) Embedment grouting.

### Condition of the system components

The RPVs are surrounded by the following components:

- Concrete filling.
- Concrete grout.
- Concrete floor.
- Backfill of macadam.
- Mechanical plugs (see Section 4.3.8).

The possibility cannot be ruled out that the RPVs will corrode during the period up to repository closure.

Other components that are emplaced prior to closure are expected to be in the condition the items had at the time of emplacement i.e. only minor changes during the operational phase.

### 4.3.8 Plugs and other closure components

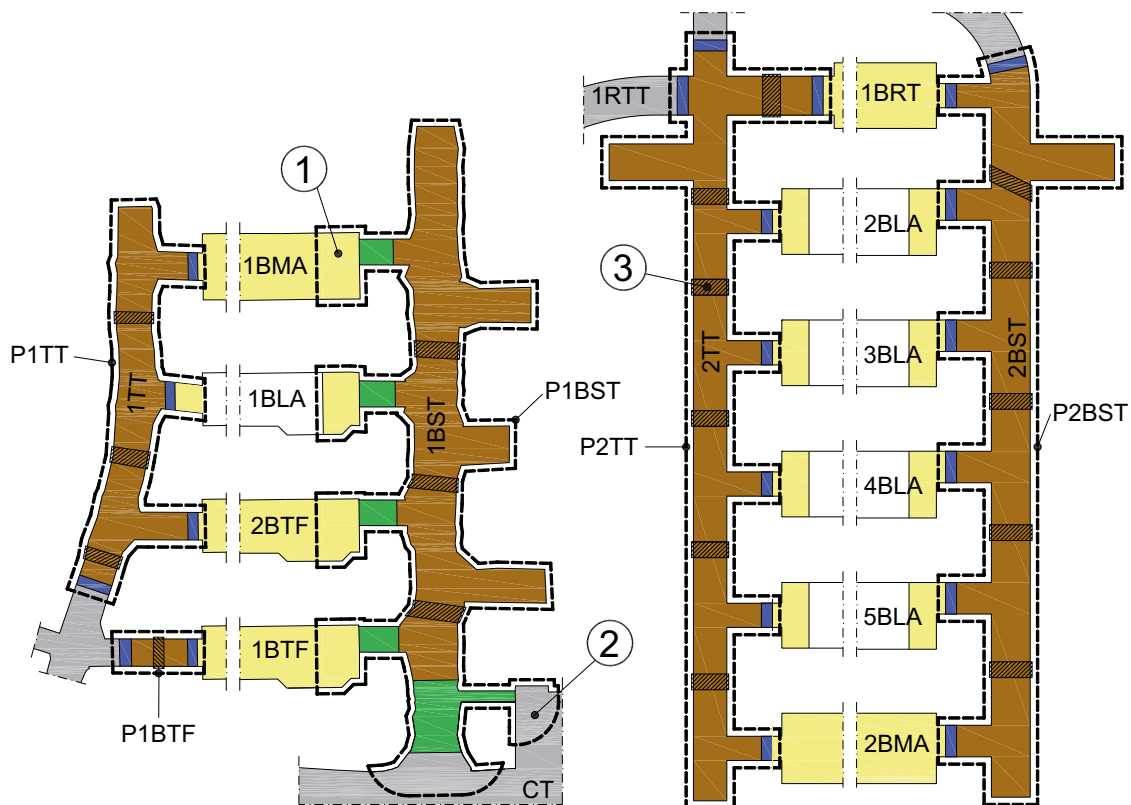
The Closure plan for SFR (SKBdoc 1358612) describes the planned measures for closure of SFR. An overall picture of the closed repository is shown in Figure 4-4. Plugs to waste vaults plus closure of tunnels, the tunnel system and boreholes are described in the following.

#### Plugs to waste vaults

A total of five plug sections (P1TT, P1BTF, P1BST, P2TT and P2BST) are to be installed to seal the waste vaults in SFR 1 and SFR 3, see Figure 4-27. All plugs consist of a hydraulically tight section and mechanical constraints that hold it in place. In most positions, concrete plugs are planned for mechanical support. In the sections adjacent to the connecting tunnel 1BST where the geometry and the local geology make it difficult to construct concrete plugs “earth dam plugs” are planned. “Earth dam plugs” do not require local mechanical support from the rock walls. The function of the bentonite-filled sections is to act as hydraulic seals and the function of the plugs is as mechanical constraints for the bentonite sections.

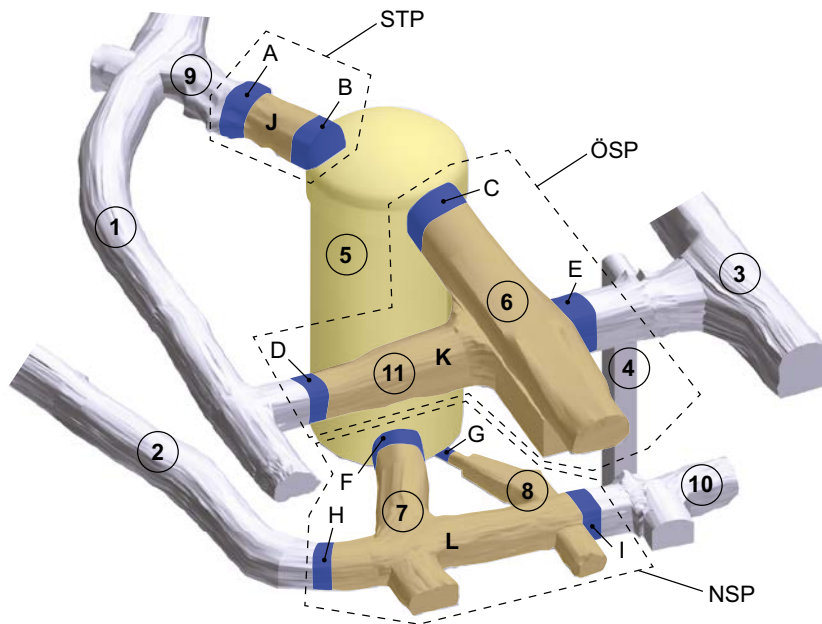
#### Plugs to silo

Three plug sections: lower silo plug (NSP), upper silo plug (ÖSP) and silo roof plug (STP) are installed to seal the silo, see Figure 4-28. An important factor in designing the plugs has been to find suitable tunnel geometries to install the mechanical constraints that hold the hydraulically tight sections with bentonite in place.



**Figure 4-27.** Plugs adjacent to waste vaults are marked with a dashed line. Key to numbering: 1) Yellow colour within borderline for plug sections shows parts of backfill in rock that are active parts of the earth dam plug, green colour shows transition material and brown colour shows hydraulically tight material 2) Grey colour within borderline for plug shows parts of backfill in tunnel system that are active parts of the earth dam plug 3) Hatched areas indicate where the damaged zone should be removed by controlled methods.

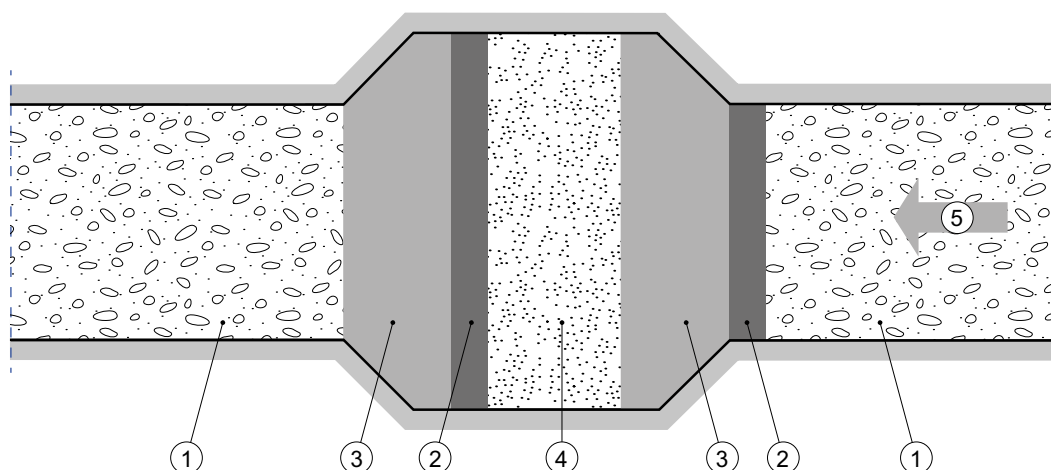




**Figure 4-28.** Illustration of closed silo with three plug sections (NSP, ÖSP and STP). Blue colour shows concrete plugs (A, B,...I) and brown colour shows hydraulically tight sections (J, K, L). Key to numbering: 1) Construction tunnel, BT 2) Lower construction tunnel, NBT 3) Central tunnel, CT 4) Connecting shaft 5) Silo 6) Loading-in building, IB 7) Silo bottom tunnel, 8) Drainage tunnel 9) Silo roof tunnel, ISTT 10) Terminal part of lower construction tunnel 11) Silo tunnel. Tunnel parts 1, 2, 3, 4 and 10 belong to the tunnel system.

#### Sealing of access tunnels and tunnel system

Plugs of concrete and bentonite, see Figure 4-4, will be installed in the access tunnels to minimise the water flow along these tunnels. The design of the plugs is shown in Figure 4-29. The tight section of bentonite is 10 m long. The remaining part of the access tunnels and tunnel system will be back-filled with macadam. The motive for choosing macadam is that it should constitute mechanical support for the plugs and impede human intrusion into the repository. In addition, vertical shafts connecting different parts of the repository are planned to be closed and plugged.



**Figure 4-29.** Schematic reference design of plug in access tunnels. Key to numbering: 1) Backfill of macadam 2) Constraining wall 3) Concrete 4) Bentonite 5) Working direction.

### **Sealing of boreholes**

The boreholes that were included in the preliminary investigations and those that intersect or are located very close to the underground facility have been or will be sealed prior to the start of construction of SFR 3, and the remaining boreholes will be sealed after operation is concluded. Where the rock has low hydraulic conductivity, the borehole seal must also have low hydraulic conductivity. In the case of positions along boreholes where the rock has high hydraulic conductivity (fractures and deformation zones), requirements are only defined for mechanical stability. Highly compacted bentonite is used where tight seals are needed and cement-stabilised plugs are cast where the boreholes pass through fracture zones.

### **Condition of the system components**

Plugs and other closure components are installed near the time of closure and are expected to be in good condition at closure.

## **4.4 Climate**

### **4.4.1 Temperature and precipitation**

The initial state with regard to temperature and precipitation in Forsmark is based on SMHI's (the Swedish Meteorological and Hydrological Institute) normal period 1961–1990. During this period, the annual mean temperature in the Forsmark area was about 5.5°C (Johansson et al. 2005). This can be compared with the annual mean temperature in the Forsmark area during the period 2004–2010, which was about 7°C (Werner et al. 2014; see Section 4.5.2 below). The difference between these values may be attributable to an increase in the annual mean temperature from 1961 onwards, but also to the fact that Werner et al. (2014) based the calculation on data for only 7 years.

Annual precipitation in the Forsmark area during the normal period 1961–1990 is represented by the nearby stations Högmasten and Storskäret. Annual precipitation during this period was 568 mm and 549 mm for these two stations (Johansson 2008). This can be compared with annual precipitation in the Forsmark area during the period 2004–2010, which was about 589 mm (Werner et al. 2013).

As a result of the increasing greenhouse effect, the annual mean temperature and annual precipitation in Forsmark are expected to increase up until the time of closure (see the **Climate report**). Based on the most recent report from the Intergovernmental Panel on Climate Change (IPCC), this increase in temperature and precipitation is estimated to be about 1–2°C and about 10–20% from the period 1986–2005 up to the time of closure (see the **Climate report**). Due to the uncertainty in the magnitude of these increases, however, the initial state is defined with reference to the normal period 1961–1990. The uncertainty in the magnitude of the future increase in temperature and precipitation is taken into account in the climate cases defined to describe the span in the future climate evolution (see the **Climate report**), which starts in 2000 and thus includes the time up until closure.

The prevailing meteorological conditions in the area affect water currents and thereby water exchange in Öregrundsgrepen, see further in Section 4.5.2.

### **4.4.2 Shoreline displacement**

Changes in the shoreline position in the Forsmark area are determined by the opposing contributions of eustasy (i.e. changes in sea level due to e.g. changes in the volume and spatial distribution of sea water in the world's oceans) and isostasy (i.e. vertical movement of the Earth's crust, which in Forsmark is dominated by rebound following the latest glaciation). SFR is situated within an area with considerable isostatic uplift – 8.4 mm per year – which dominates shoreline displacement in the area today. The eustatic contribution to shoreline displacement is expected to increase during the coming centuries to millennia, so that shoreline displacement in the Forsmark area will slow down or even change direction to transgression during the next century (see the **Climate report**).

At closure, the shoreline is assumed to be located in the same position as today. The maximum difference between this assumed position and the actual position can be estimated with reference to a compilation of shoreline displacement estimates up until 2100 (see the **Climate report**). The vertical component of shoreline displacement between 2000 and 2100 is expected to be between about  $-0.8$  m (assuming a negligible eustatic contribution) and about  $+1.5$  m (assuming a maximum eustatic contribution).

## 4.5 Surface systems

### 4.5.1 Topography and regolith

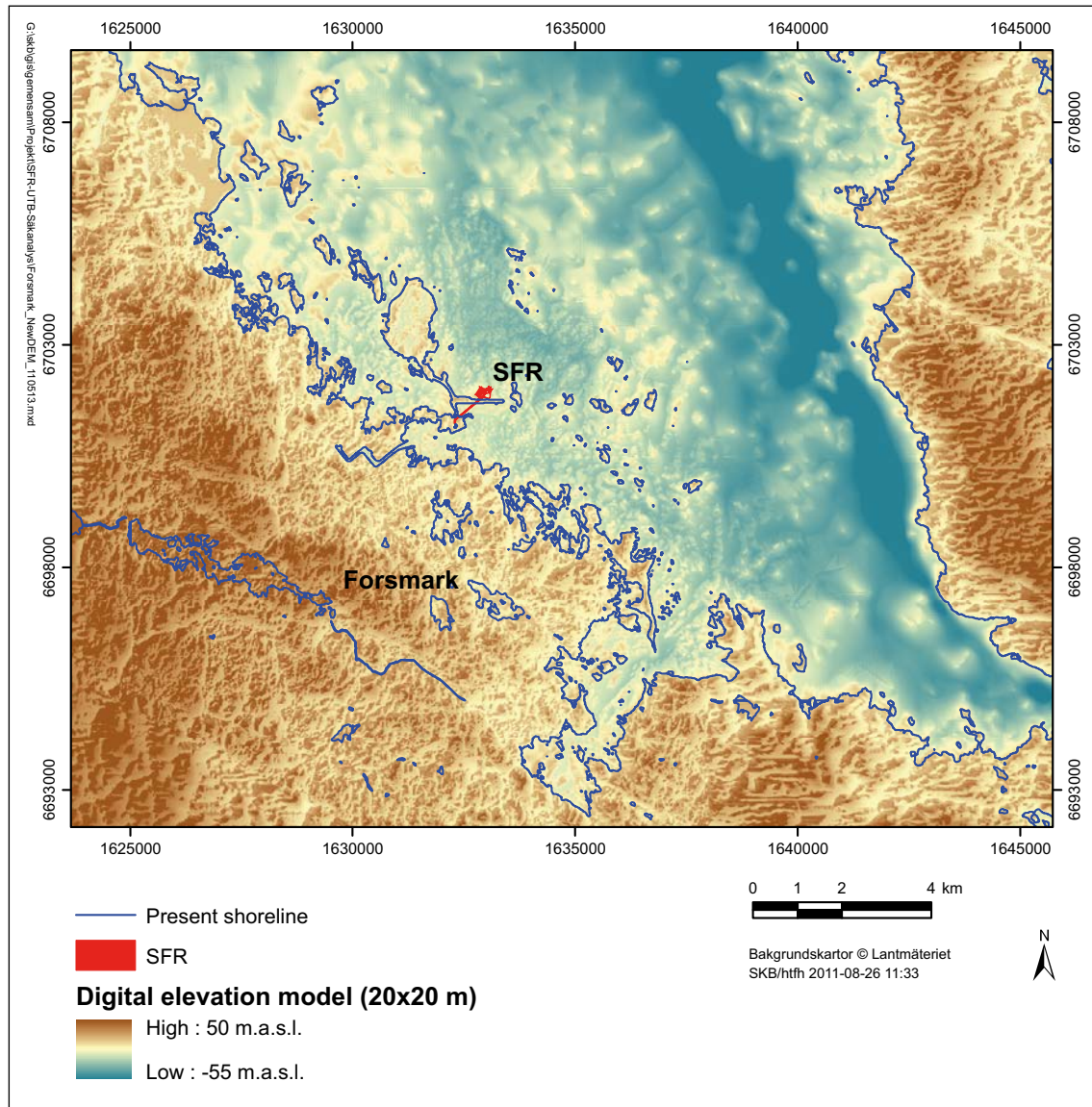
The topography of the Forsmark area is characterised by low relief (Figure 4-30). The relief is more pronounced west and south of the Forsmark area, where the relative relief reaches 50 m elevation in a landscape characterised by bedrock-controlled lineaments and fracture zones oriented largely in the directions N–S and NW–SE.



*Figure 4-30. The Forsmark area seen from the southeast with the only larger arable land area, Storskäret, in the foreground.*

A DEM (digital elevation model) that is an update of a previously developed DEM (Strömgren and Brydsten 2008) has been developed in the SR-PSU project to describe the topography of the Forsmark area (Figure 4-31). The DEM, which has a resolution of 20 m, is a central data source for the site characterisation, and is used as input to most of the descriptions and models of the surface system. A detailed description of the DEM is provided in Strömgren and Brydsten (2013).

In terrestrial areas of Forsmark, elevation differences are usually less than 20 m. Prominent topographical features of the landscape are the relatively small glacial landforms such as eskers. The highest point in the DEM area is at 50 m elevation and is located in the south-western part of the area. In the marine area, a deep trough (Gräsörännan) runs in the NNW–SSE direction in the eastern part of the embayment, and the lowest point (–55 m elevation) is located in the northern part of this trough.



**Figure 4-31.** DEM (digital elevation model) of the Forsmark area, including the bathymetry (bottom level) of lakes and the near-coastal sea (Strömgren and Brydsten 2013). The map shows present lake shorelines, the present shoreline of the sea and the location of SFR 1.

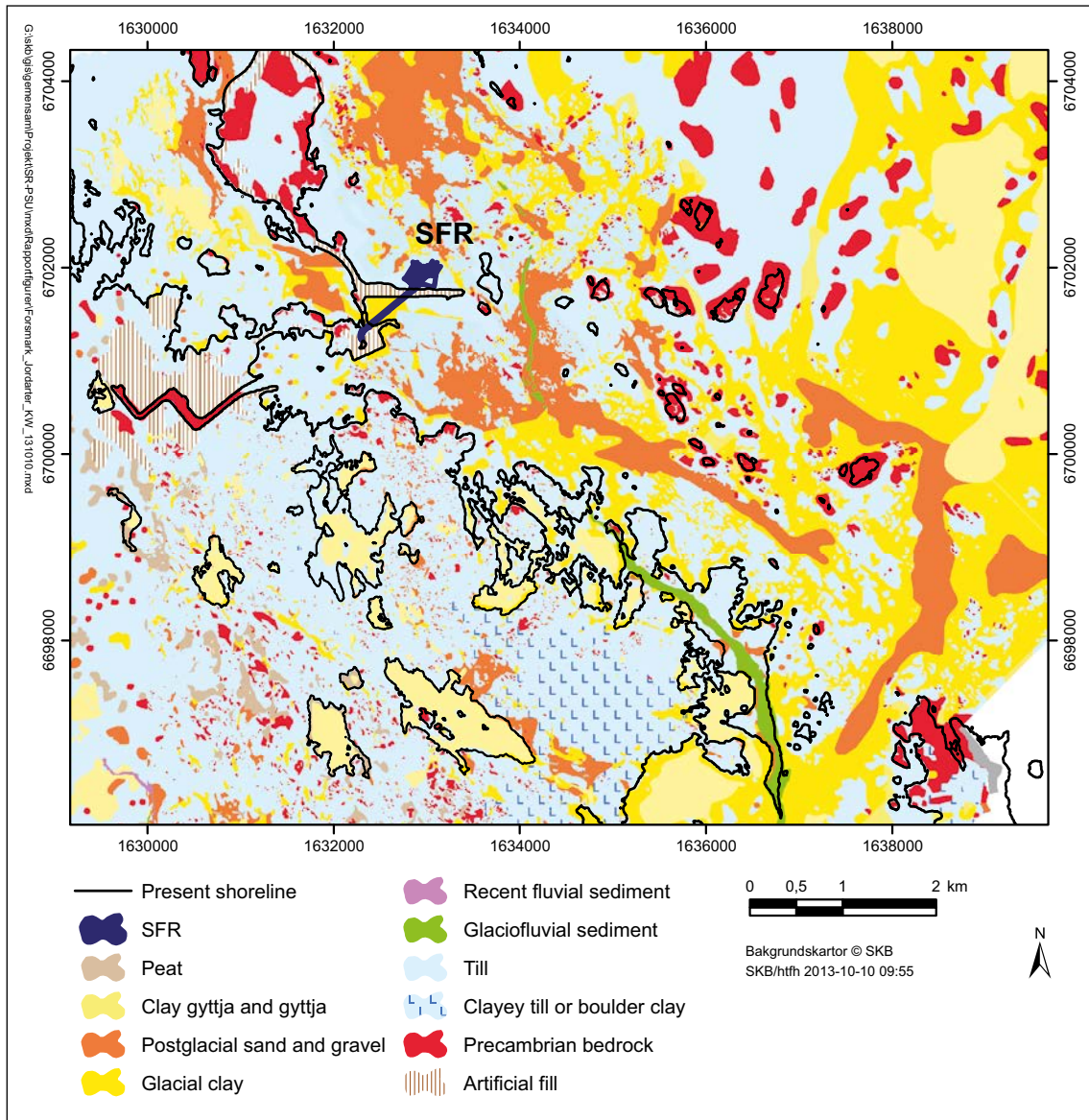
In the Forsmark area, as in other parts of Sweden, most regolith (unconsolidated deposits above the rock) was formed during or after the final phase of the latest glaciation, which in Forsmark was completed around 8800 BC. Since it was formed during the Quaternary period, regolith is commonly denoted Quaternary deposits. The upper part of the regolith is called sediment in aquatic systems and soil in terrestrial systems. Sediments and soils are affected by a number of processes, e.g. deposition, decomposition of organic material, bioturbation, erosion, and in terrestrial areas also frost action and weathering. Data describing regolith properties are an important input when modelling the hydrology and transport of elements and various compounds within the biosphere and between the geosphere and the biosphere. Soil properties are also strongly associated with the classification of vegetation types and land use in terrestrial ecosystems.

The surface distribution of regolith in Forsmark is typical for areas located below the highest post-glacial coastline (Figure 4-32). Till is the dominant type of regolith in the highest topographical areas and occupies some 65% of the surface in terrestrial areas and 30% of the sea floor outside Forsmark. A glaciofluvial deposit, Børstilåsen, has N–S and NW–SE directions along the coast of the mainland, and a continuation on the sea floor east of SFR. Glacial clay occurs primarily in depressions on the sea floor and beneath present-day lakes. Postglacial sand often covers the glacial clay. Postglacial clay gyttja, rich in organic material, is predominantly found and is currently being deposited in shallow bays and on the deepest parts of the sea floor. Gyttja mainly consists of organic material and is currently being deposited in the lakes. Peat is accumulating in fens and along the shores of the lakes. The sea floor around the SFR pier is dominated by till and in the lower topographical areas by glacial clay covered with sand. The shallowest areas and islands have a high proportion of exposed rock. The descriptions of the spatial distribution of regolith and its properties are based on primary data obtained from extensive field mapping, investigations in the form of drilling, excavations and geophysics, and physical and chemical laboratory tests (for further details, see Sohlenius et al. (2013a), Hedenström and Sohlenius (2008) and Lundin et al. (2004)).

Compared with most other parts of Sweden, regolith in the Forsmark area has only been subject to soil-forming processes for a relatively short period of time due to its recent rise above the shoreline, and most of the regolith is therefore immature and lacks distinct soil horizons (Lundin et al. 2004). Till and glacial clay in Forsmark have a high content of calcium carbonate ( $\text{CaCO}_3$ ), which originates from Palaeozoic limestone that outcrops on the sea floor north of the Forsmark area. The high content of  $\text{CaCO}_3$  in the soils strongly affects their chemical properties.

A regolith depth and stratigraphy model, which is an update of a previously developed model (Hedenström et al. 2008), has been constructed to provide a geometric model of thickness and surface distribution of regolith layers at a landscape level (Figure 4-33). The regolith depth model (RDM) is based on the general top-down stratigraphy of the Forsmark area, consisting of peat, gyttja and clay gyttja, postglacial sand/gravel, glacial clay, glaciofluvial sediments, and till. A detailed description of the RDM is provided in Sohlenius et al. (2013a).

The total regolith depth in the RDM area varies between 0.1 and 47 m. The coastal zone and the islands (including the coastal zone of the island of Gräsö) are characterised by thin regolith and frequent rock outcrops (Figure 4-33). Generally, the regolith is deeper in the marine area, with an average thickness of about 8 m, whereas the average thickness in the terrestrial area is about 4 m. The regolith thickness on the sea floor around the SFR pier is 1–4 m.



**Figure 4-32.** Surface distribution (at a depth of 0.5 m) of regolith and areas of exposed rock in the Forsmark area. Note that lakes and the sea are shown without surface water.

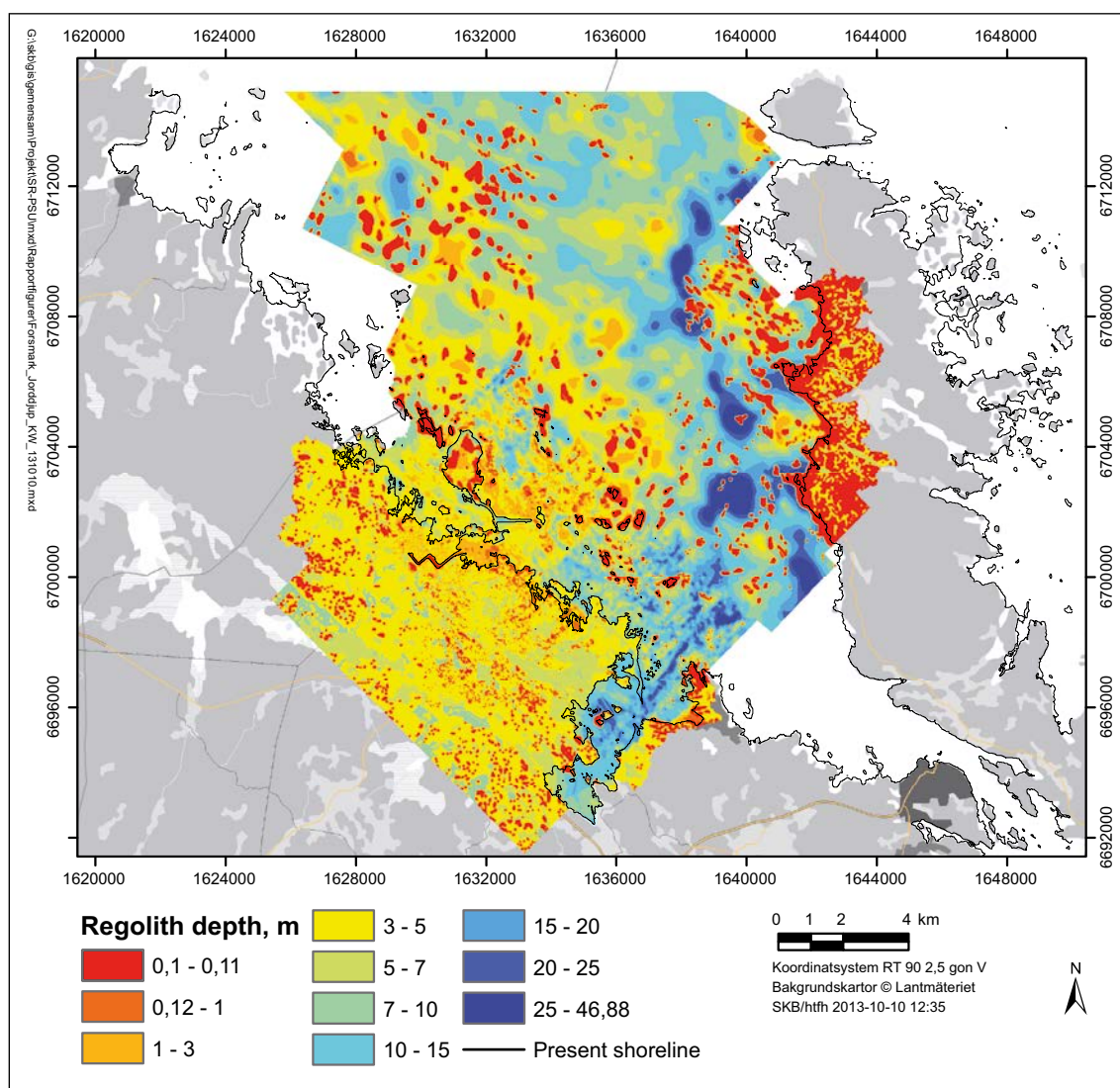


Figure 4-33. Regolith depth map based on the Regolith Depth Model (RDM) for Forsmark (Sohlenius et al. 2013a).

#### 4.5.2 Meteorology, hydrology, near-surface hydrogeology and water chemistry

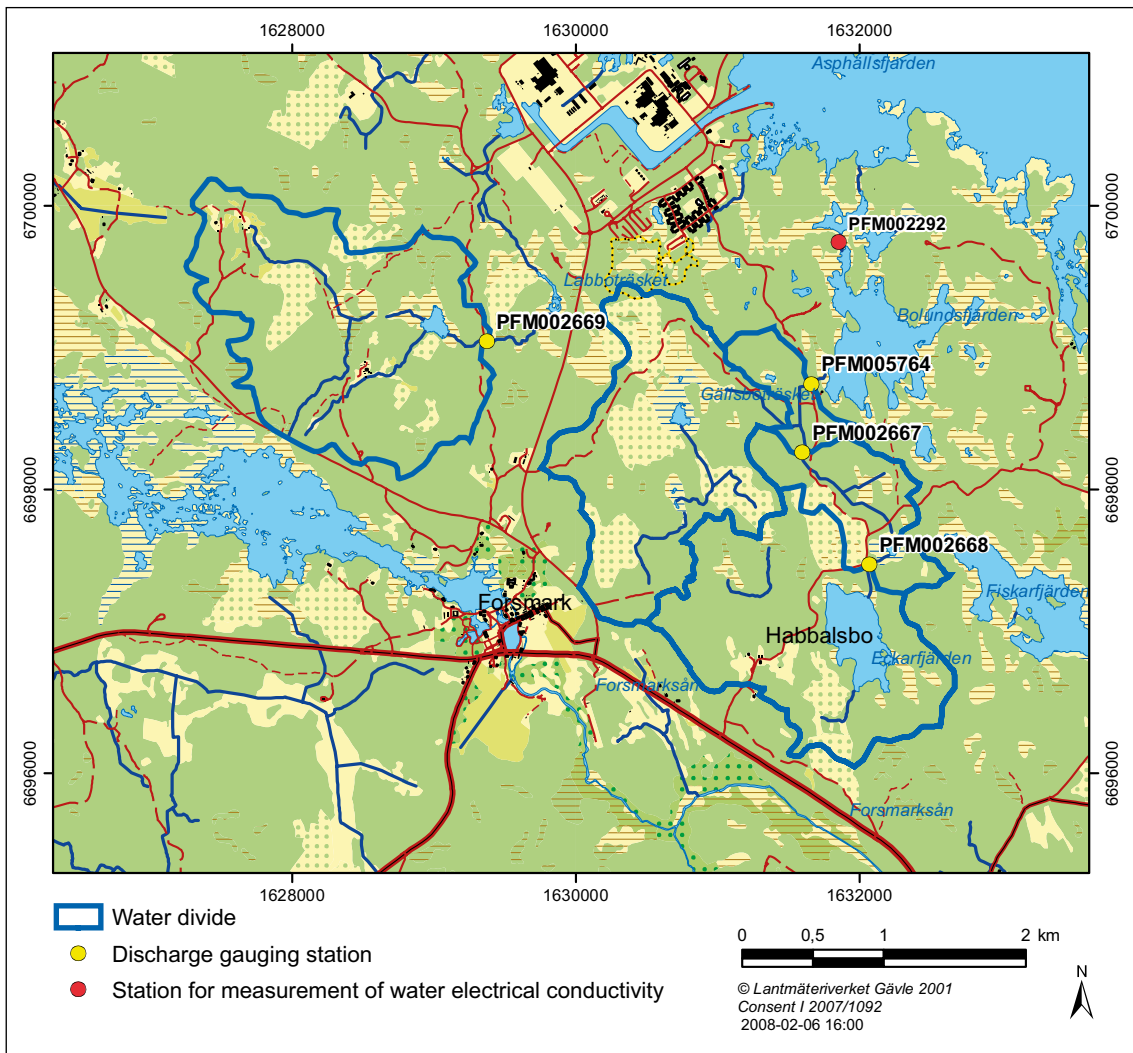
As described in Section 4.4.1, the initial state with regard to air temperature and precipitation at Forsmark is defined based on the SMHI normal period 1961–1990. The annual average air temperature was about 5.5°C and annual precipitation was about 560 mm during this period (Johansson 2008, Werner et al. 2014). The vegetation period (mean air temperature above +5°C) lasts approximately from May to September (data from 2004–2010, Werner et al. 2014). The dominating wind direction is from the southwest. The calculated mean annual potential evapotranspiration was 509 mm (for the period 2004–2010). Some 25–30% of the annual precipitation falls in the form of snow, and the period of snow cover is typically from the end of November until the beginning of April. Based on the meteorological and hydrological monitoring programme (including data from surrounding stations operated by SMHI), the long-term water balance of the Forsmark area can be estimated as: precipitation = 560 mm/yr, actual evapotranspiration = 400–410 mm/yr, and runoff = 150–160 mm/yr (Werner et al. 2014).

Altogether, 25 lake-centred catchment and sub-catchment areas (sizes 0.03–8.67 km<sup>2</sup>) have been delineated within the area (Figure 4-34, Brunberg et al. 2004, Andersson 2010). Wetlands are common and cover 10–20% of the Forsmark area (Löfgren 2010). The largest lakes in the area are Fiskarfjärden, Bolundsfjärden and Eckarfjärden (Figure 4-35a). Even the largest lakes are smaller than 1 km<sup>2</sup> and are shallow (average depth is about 1 m). Seawater intrusion occasionally occurs into the lakes located close to the sea during periods of very high sea level. The streams in Forsmark are small (Figure 4-35b) and long stretches are dry in the summer.

Generally, the lakes are recipients of groundwater discharge for most of the year. However, intense evapotranspiration in the summer lowers groundwater levels, and some lakes may periodically switch to being recharge areas. Due to the low hydraulic conductivity of the bottom sediments, the resulting water fluxes can be assumed to be relatively small.

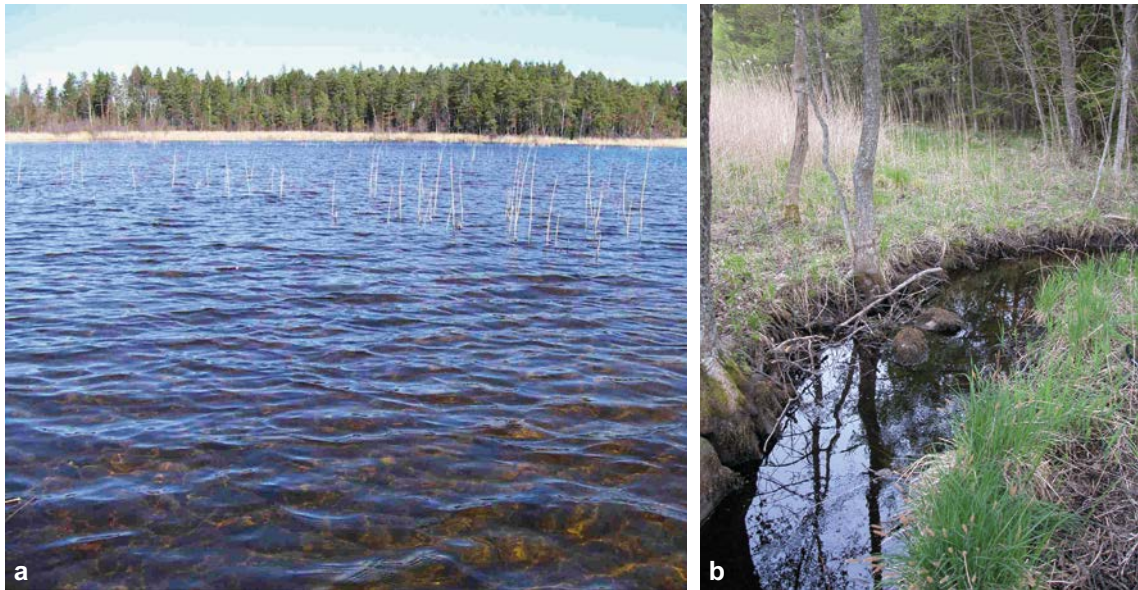
The infiltration capacity of the regolith generally exceeds rainfall and snowmelt intensities, and groundwater recharge is dominated by precipitation and snowmelt (Johansson 2008). The horizontal hydraulic conductivity of the till that dominates the area decreases with depth from about  $10^{-5}$  m/s near the ground surface to about  $10^{-6}$  and  $10^{-7}$  m/s at depth for coarse and fine-grained till, respectively (Johansson 2008). Moreover, there are indications that the hydraulic conductivity is higher at the rock–regolith interface than in the till itself. The till is anisotropic, with a horizontal hydraulic conductivity that is on the order of 30 times greater than the vertical conductivity.

The groundwater table in the regolith is generally shallow (within 1 m of the ground surface) and follows the ground-surface topography. Hence, surface-water divides and groundwater divides in the regolith can be assumed to coincide. The small-scale topography results in shallow, local groundwater flow systems in the regolith that overlie larger-scale flow systems in the rock. Point water heads measured in the rock close to the SFR facility are at or below the current sea level.



**Figure 4-34.** Overview map of lakes, streams and discharge-gauging stations. SKB’s meteorological station Högmasten is located near the shoreline, south of the cooling-water channel for the Forsmark nuclear power plant. In 2012, a new meteorological station (Labbomasten) was established at drilling site 1 south-west of PFM002292.





**Figure 4-35.** a) Lake Eckarfjärden, one of the larger lakes in the Forsmark area. Like other lakes in the area, Eckarfjärden is a shallow oligotrophic hard water lake surrounded by reed. b) The largest stream in Forsmark, near the inlet to Lake Bolundsfjärden.

The marine area at Forsmark consists of the open-ended embayment Öregrundsgrepen, with a wide and deep boundary towards the north and a narrow and shallower strait towards the south. Based on the sea bathymetry according to the DEM (Strömngren and Brydsten 2013), the present-day marine area outside Forsmark is divided into 38 basins. The salinity stratification in Öregrundsgrepen is generally weak. Local freshwater runoff produces a slightly lower salinity than in the Gulf of Bothnia (Aquilonius 2010). The direction of the flow through Öregrundsgrepen varies with time, but on an annual basis there is a net flow directed from north to south (Karlsson et al. 2010).

The water retention time (average age in the 38 basins) was calculated to vary between 13 and 29 days (average 19, Werner et al. 2014). Water exchange is more rapid in the deeper areas close to the open Bothnian Sea, whereas it is slower in the partly isolated shallow coastal basins.

The high content of calcium carbonate in the regolith and the recent emergence of the area above sea level affect the chemistry of surface water and shallow groundwater. Specifically, surface water and shallow groundwater in Forsmark are generally slightly alkaline (pH 7–8) and have high contents of major constituents, due to marine and glacial remnants deposited during the latest glaciation. Calcite has had a strong influence on the development of terrestrial and limnic ecosystems at the site. For instance, secondary calcite precipitation and co-precipitation of phosphate contribute to the development of the nutrient-poor oligotrophic hard water lakes that are characteristic of the Forsmark area (see Section 4.5.4 and Andersson 2010). The rich supply of calcium also influences soil formation and the development and structure of the terrestrial ecosystems (Löfgren 2010).

The distribution of different elements among biotic and abiotic pools, together with estimates of element fluxes into and out of the pools, gives an overall picture of major sources and sinks of elements in the landscape (Tröjbom and Grolander 2010). The results show that by far the largest fraction of most elements in both terrestrial and limnic ecosystems is found in soils and sediments. The only pools in the landscape that are not negligible in comparison with the total regolith pool are those of nutrients and essential trace elements found in organisms in terrestrial ecosystems. This pattern is due to the large biomass in terrestrial ecosystems compared with limnic ecosystems.

Knowledge of the hydrogeochemistry of the surface system at Forsmark is based on extensive site investigations and modelling of limnic, marine and terrestrial systems including surface water, pore water, regolith and sediments (Sonesten 2005, Tröjbom and Söderbäck 2006, Tröjbom et al. 2007, Andersson 2010, Aquilonius 2010, Qvarfordt et al. 2010, Hedenström and Sohlenius 2008, Löfgren 2010, Sheppard et al. 2009, 2011, Tröjbom and Grolander 2010, Tröjbom and Nordén 2010,

Löfgren 2011). There is an ongoing long-term hydrochemical monitoring programme at the site that includes surface waters and groundwater from regolith and rock (SKB 2007). Supplementary sampling and analyses of regolith and biota have also been performed in order to model transport of elements (Sheppard et al. 2011), and mobility of elements in relation to the chemistry in agricultural soils and wetlands has been investigated based on site data (Sohlenius et al. 2013b). Moreover, transport and uptake of radionuclides in coastal ecosystems have been modelled using different models to determine concentration ratios for biota given the ambient water chemistry (Erichsen et al. 2013).

### 4.5.3 Marine ecosystems

Brackish conditions, shallow waters, subdued bathymetry, restricted light penetration and up-welling along the coast characterise the marine ecosystems at Forsmark. Together, these factors result in high primary production in the near-shore zone in a region of otherwise fairly low production (Aquilonius 2010). Primary production is lower in areas with greater water depths, where it is mainly restricted to the upper water column with good light conditions. The low salinity of the seawater in the area results in a low diversity of fauna as few organisms are adapted to such brackish conditions. The primary producers are dominated by benthic organisms such as microalgae, vascular plants and benthic macroalgae. The fauna are dominated by detritivores (i.e. snails and mussels feeding on dead organic material) on both hard bottom and soft bottom substrates. The fish community is dominated by the marine species herring (*Clupea harengus*) in the pelagic zone, whereas limnic species (especially Eurasian perch, *Perca fluviatilis*) dominate in near-coastal areas and in secluded bays.

Both abiotic and biotic processes influence transport and accumulation of elements in marine ecosystems (Figure 4-36). However, modelling of carbon budgets shows that advective flux (water exchange) is often the dominant factor for transport and accumulation of elements (particularly in open and more offshore basins), and by comparison, biotic fluxes (i.e. transport within the system) are less important.

Modelling of marine basins shows that the whole marine area on average has positive Net Ecosystem Production (NEP). Specifically, shallow areas near the coastline have positive NEP, whereas more offshore areas have negative NEP. An extensive description of the marine ecosystems – including availability of primary data, evaluations of data, and marine models for the Forsmark area – is provided in Aquilonius (2010).

### 4.5.4 Limnic ecosystems

As mentioned above, present-day lakes in the Forsmark area are small and shallow (Figure 4-35a). They are characterised as oligotrophic hardwater lakes, with high calcium and low nutrient levels (Andersson 2010). This lake type is common along the coast of northern Uppland, but rare in the rest of Sweden (Brunberg et al. 2002, Hamrén and Collinder 2010).

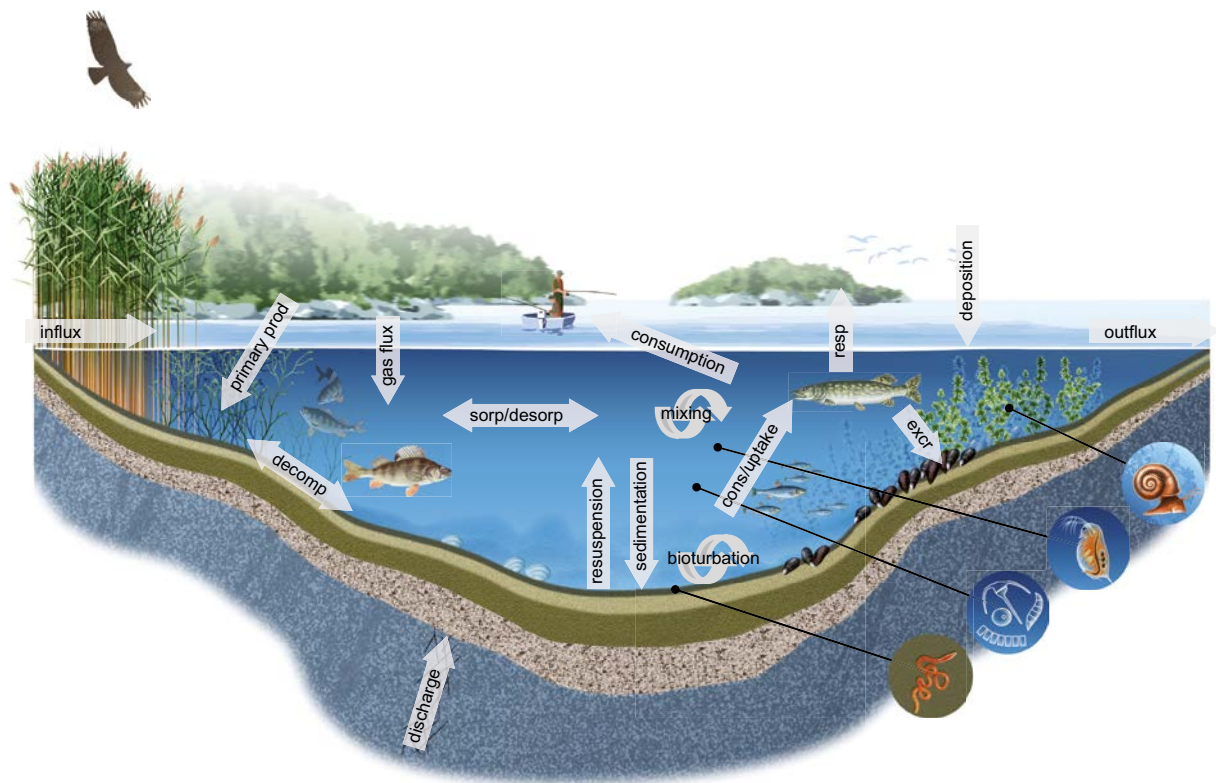
Shallow depths and moderate water colour permit photosynthesis in the entire benthic habitat, and the lake bottoms are covered by dense stands of macroalgae and a thick layer of microphytobenthos (microscopic algae and cyanobacteria). These two types of primary producers dominate the biomass and primary production, making phytoplankton biomass and production less important.

All lakes are surrounded by reed belts, which are extensive especially around the smaller lakes. The fish community in the lakes of Forsmark is dominated by perch (*Perca fluviatilis*), roach (*Rutilus rutilus*), tench (*Tinca tinca*) and crucian carp (*Carassius carassius*), of which the two latter species are resistant to low oxygen concentrations during winter.

As also mentioned above, the streams in the Forsmark area are small and long stretches of these streams are dry in summer. However, some streams close to the coast carry water for most of the year and may function as passages for migrating spawning fish, and extensive spawning migration has been observed between the sea and Lake Bolundsfjärden. The abundance of vegetation in the streams is heterogeneously distributed, varying between 0 and 100% coverage of the stream bed but with some longer sections with intense growth (75–100% coverage) (Andersson et al. 2011).

Both abiotic and biotic processes influence transport and accumulation of elements in limnic ecosystems (Figure 4-36). Modelling of carbon dynamics in limnic ecosystems shows that, in contrast to typical Swedish lakes, primary production exceeds respiration in many lakes in the Forsmark area (Andersson 2010). In some of the larger lakes in the area (e.g. Bolundsfjärden and Eckarfjärden), primary production involves large amounts of carbon compared with the amounts that are transported from the surrounding catchment area. Consequently, there is a great potential for inorganic carbon entering the lakes to be incorporated in the lake food web via primary producers. However, much of the primary-produced carbon is circulated within the microbial food web and transferred back to abiotic pools or sequestered in sediments.

In the larger lakes, there is a relatively high degree of accumulation in sediments, which can be a permanent sink for radionuclides and other pollutants. In smaller lakes, the amounts of carbon involved in primary production are small compared with the amounts transported from the surrounding catchment area. According to the ecosystems modelling, these lake systems function more as through-flow areas. The chemical properties of the elements, the size of a lake and its location in its catchment area determine the fate of elements entering the lake system. An extensive description of the limnic ecosystems – including availability of primary data, evaluations of data, and limnic models for the Forsmark area – is provided in Andersson (2010).



**Figure 4-36.** Conceptual model of important fluxes affecting transport and accumulation of elements in aquatic (i.e. limnic and marine) ecosystems. The aquatic ecosystems and important processes and fluxes in these are further described in the limnic and marine ecosystem reports (Andersson 2010, Aquilonius 2010).

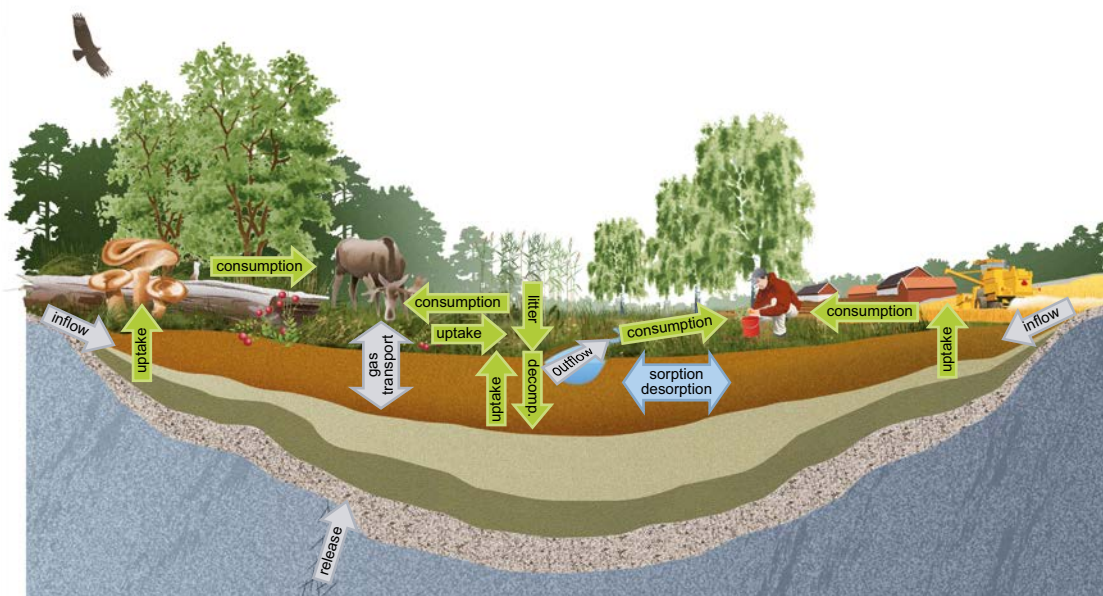
#### 4.5.5 Terrestrial ecosystems

The terrestrial vegetation is strongly affected by topography, regolith characteristics and human land use. Some three quarters of the land area in Forsmark is covered by forests, dominated by Scots pine (*Pinus sylvestris*) and Norway spruce (*Picea abies*) (Löfgren 2010). Due to the calcareous regolith, the field layer is characterised by herbs, broad-leaved grasses and many orchid species. The area has a long history of forestry, with a high percentage of younger and older clear-cuts in different succession stages. As mentioned previously, wetlands are common. Most wetlands are coniferous forest swamps or open mires. Less mature wetlands consist of rich fens due to the high calcareous content of the regolith. Agricultural land (arable land and grassland) covers only a small part of the land area of Forsmark.

The most common larger mammal species in the Forsmark area are roe deer (*Capreolus capreolus*) and moose (*Alces alces*). In total, 96 bird species have been found in the Forsmark area. The most common species in Forsmark are, as in the rest of Sweden, chaffinch (*Fringilla coelebs*) and willow warbler (*Phylloscopus trochilus*) (Löfgren 2010). It can be concluded that Forsmark is a very valuable area from a nature conservation point of view. The highest nature values are associated with wetlands and forests containing red-listed and/or legally protected species (Hamrén and Collinder 2010). Two such rare species are the fen orchid (*Liparis loeselii*) and the pool frog (*Rana lessonae*), which both have a restricted national distribution range and are found in this area.

Modelling of carbon dynamics for two conifer forests (i.e. the dominant vegetation type in Forsmark) and one forested wetland show that the largest carbon flux in terrestrial ecosystems is the uptake of carbon by primary producers, and that the vegetation on all the investigated localities acts as a carbon sink (Löfgren 2010). This net primary production sets an upper limit on the potential uptake of different elements into biomass, which in turn limits the extent of further propagation up the food web. Eventually, biomass reaches the soil compartment as litter and is mineralised. The balance between litter production and heterotrophic respiration determines to what extent organic material (and incorporated elements) can be accumulated in the soil.

Dynamic vegetation modelling shows that other vegetation types (e.g. deciduous trees, meadows and arable land) are also carbon sinks, with the exception of clear-cut areas, which act as carbon sources. Figure 4-37 illustrates a compilation of important processes for a mire ecosystem. An extensive description of the terrestrial ecosystems – including availability of primary data, evaluations of data, and terrestrial models for the Forsmark area – is provided in Löfgren (2010).



**Figure 4-37.** Conceptual model of important fluxes affecting transport and accumulation of elements in a wetland ecosystem and arable land on a drained part of a mire (Löfgren 2010). Green arrows are fluxes mediated by biota (including water for drinking), grey arrows are water and gas fluxes, the blue arrow represents sorption/desorption processes. The mire was preceded by a lake stage and a marine stage, in which gyttja/clay and postglacial clay were deposited prior to the peat. The terrestrial ecosystems and important processes and fluxes in these are further described in the terrestrial ecosystem report (Löfgren 2010).

#### 4.5.6 Wells and water resources management

All public water supply in the Municipality of Östhammar is based on groundwater (Werner et al. 2010). The public water supply closest to SFR is located at the Börstilåsen esker, several kilometres southeast of SFR. According to the present municipal comprehensive plan, which is expected to be replaced by a new plan in 2015, there are no future needs for public water supplies in areas close to SFR.

At present, around 30% of the inhabitants in Östhammar obtain their drinking water from private wells. The owner of the Forsmark nuclear power plant has previously drilled a number of boreholes in rock to prospect for water, but these boreholes are no longer in use. Today, there are some private wells (dug in regolith or drilled in rock) in land areas along the coast. Analyses of the well water show that the water quality varies from potable to non-potable. Some wells are not used as drinking-water supplies but instead for other purposes, e.g. irrigation of garden plots.

According to a regional analysis of well density (both dug and drilled wells), the current well density varies between about 0.2 and 2 wells per km<sup>2</sup> depending on size and location of the analysed area (Kautsky 2001). The well density is 0.2–0.9 wells per km<sup>2</sup> in different sub-areas within an area close to SFR (size 400 km<sup>2</sup>) and 0.5–2 wells per km<sup>2</sup> in different sub-areas within northern Uppland (size 3,300 km<sup>2</sup>).

According to an analysis of data from the SGU Well Archive (©Geological Survey of Sweden, SGU) for more than 5,000 private wells drilled in rock in Northern Uppland (see Gentzschein et al. 2007), a typical well depth in rock is about 60 m. Based on hydraulic tests in core boreholes at the SFR facility, the median hydraulic conductivity in the depth interval 0–100 m is estimated at about  $1.5 \cdot 10^{-7}$  m/s. For a well depth in rock of 60 m, the equivalent maximum well capacity is about 1,900 L/h.

Current water management in Forsmark includes groundwater diversion from SFR, a cooling-water channel from the sea to the Forsmark nuclear power plant, the use of Lake Bruksdammen as a water source, and a groundwater-drainage system at the nuclear power plant. There are no land improvements or drainage activities registered in public records. However, there are shallow ditches in the forests (for drainage purposes), and the lake outlet from Lake Eckarfjärden has previously been lowered in order to lower the level of the lake. Some minor natural springs have been observed in the area, but no springs are registered in public records.

#### 4.5.7 Human population and land use

There are holiday houses but no permanent residents in a 20 km<sup>2</sup> area around SFR (Miliander et al. 2004). Land use has previously been dominated by commercial forestry, and timber extraction has been the only significant man-made outflow of biomass from the area. The only current agricultural operation is situated at Storskäret. It is focused on meat production and the cattle graze outdoors during the vegetation period.

The Forsmark nuclear power plant is a large industrial activity in an otherwise relatively undisturbed area. The dominant leisure activity in the area is hunting. Forsmark is only occasionally used for leisure activities due to the small local population, the relative inaccessibility of the area and the distance from major urban areas.

### 4.6 Bedrock

Geology and rock mechanics in the Forsmark area are described in detail in the Site Descriptive Model for the SFR area, SDM-PSU (SKB 2013e). The prevailing conditions are summarised in the following section.

#### 4.6.1 Bedrock temperature

At initial state, the temperature in the repository and the rock at repository level will be similar to the present-day bedrock temperature, i.e. about 5–7°C (Sundberg et al. 2009, Väisäsvaara 2009). As described in Section 4.5.1, the air temperature is expected to increase by about 1–2°C up to the time of repository closure. However, because of the uncertainty in the magnitude of the air temperature increase, the initial state is defined with reference to the normal period 1961–1990.

## 4.6.2 Rock types and rock domains

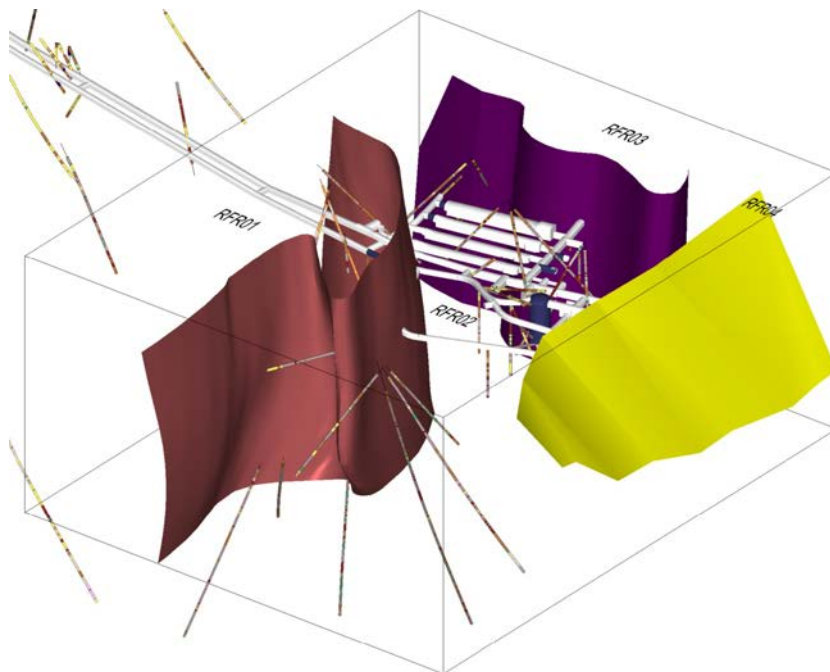
The area at SFR has been divided into four domains (RFR01–RFR04) with similar conditions with regard to rock types. Domain RFR01 is dominated by pegmatite to pegmatitic granite (SKB rock type code 101061). Domain RFR02 has a much more heterogeneous composition than RFR01. The domain locally consists of fine- to medium-grained metagranite-granodiorite (101057), which is difficult to distinguish from the more common rock type in this domain, felsic to intermediate metavolcanic rock (103076). The domain also contains 24% pegmatite and pegmatitic granite. Both SFR 1 and SFR 3 are situated for the most part in domain RFR02, whereas the access tunnels are situated in RFR01, see Figure 4-38.

There are no data from drill cores or tunnels for domain RFR03, but the interpretation of magnetic measurements indicates that the domain consists of oxidised rock in deformation zones and rock volumes dominated by pegmatite. Data are also lacking for RFR04, but the assessment is that the rock type composition is similar to that in RFR02. The rock type composition in RFR03 and RFR04 is uncertain, but due to the peripheral location of these domains, the uncertainty is not important.

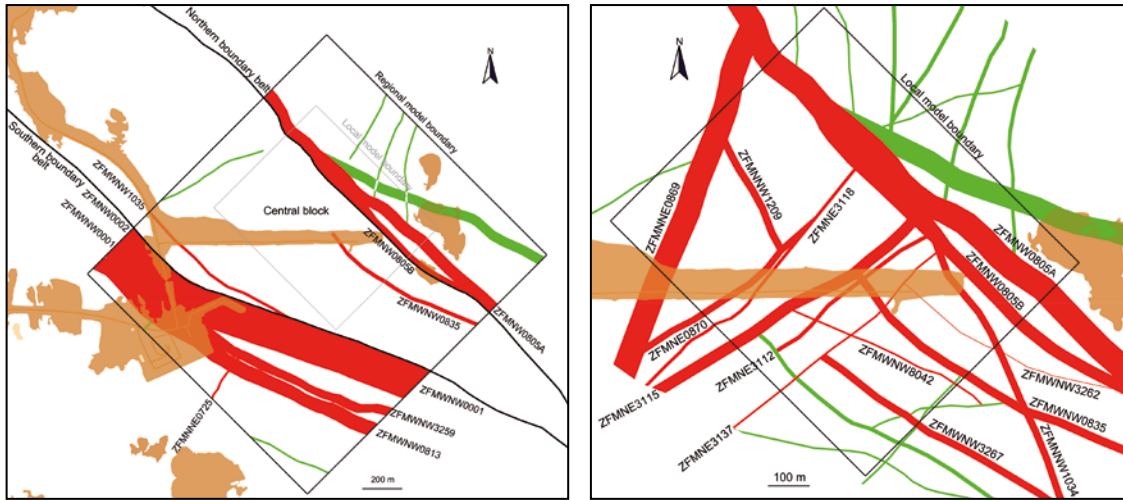
## 4.6.3 Deformation zones and subhorizontal superficial structures

A model has been constructed that shows the interpreted deformation zones in the area based on available information (see Figure 4-39 and Figure 4-40). The deformation zones are divided into different groups of zones, namely:

- 1) Vertical to steeply dipping zones with a WNW to NW strike. Six zones in the Central Block belong to this group, and some of them are expected to intersect the planned rock volume for SFR 3.
- 2) Vertical to steeply dipping zones with a NNE to ENE strike. These zones are shorter compared with zones in group 1. The group consists of a total of seven zones, one of which lies within the Central Block.
- 3) Vertical to steeply dipping zones with a NS to NNW strike. These end at zones belonging to the preceding two groups. This group includes two zones that intersect the Central Block.
- 4) Moderately to gently dipping ( $\leq 45^\circ$ ) zones. The group consists of a total of three zones, one of which lies within the Central Block (see Figure 4-42).

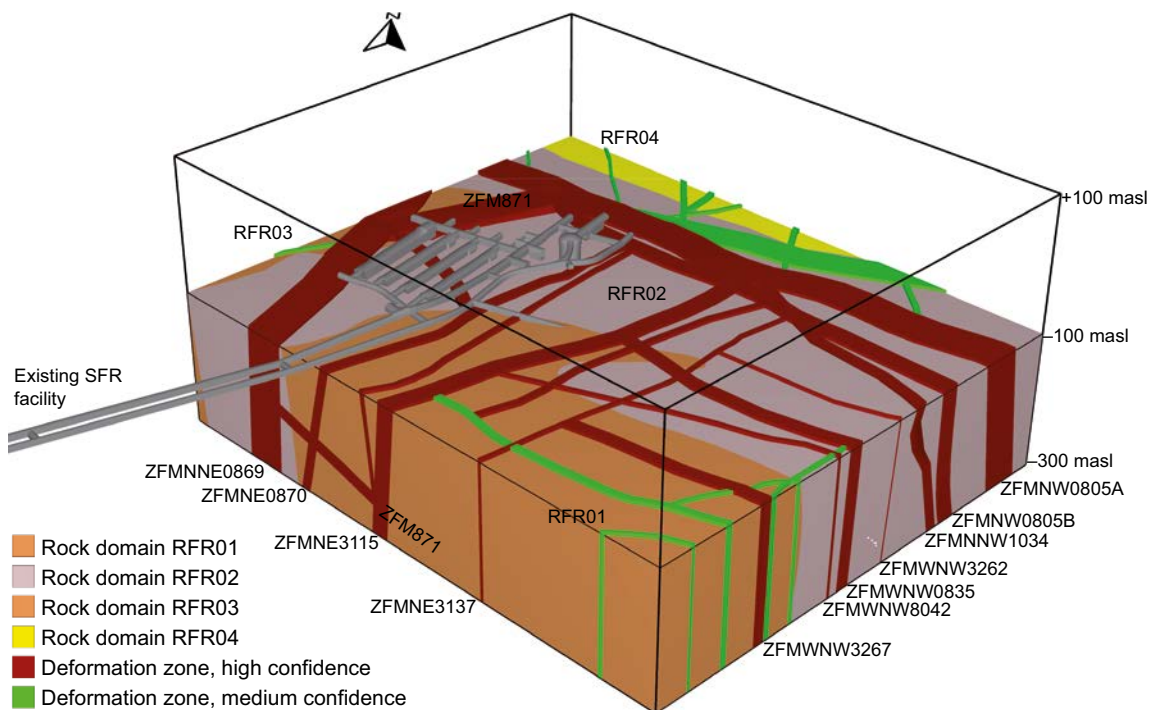


**Figure 4-38.** 3D view of SFR 1 towards the west. The coloured areas show the boundaries between the different rock domains. The area for SFR 3 is located for the most part in domain RFR02, on the side towards the viewer (SKB 2013e).



**a) Regional model area, trace lengths  $\geq 1,000$  m**      **b) Local model area, trace lengths  $\geq 300$  m**

**Figure 4-39.** Intersection of deformation zones with the rock surface. a) Regional model area. The large regional zones ZFMWNW0001 and ZFMNW0805A comprise, along with their splays, the boundaries of the central tectonic block in which both SFR 1 and SFR 3 are situated. The colours indicate confidence in the model with regard to the existence of the zones: high = red, medium = green. The brown area indicates what is currently dry land. b) Local model area (SKB 2013e).



**Figure 4-40.** Rock domains and deformation zones in the SFR local model, version 1.0 viewed obliquely downwards towards the north. The block location is shown in Figure 4-39 (SKB 2013e, Figure 5-2).

Besides these deformation zones, there are subhorizontal superficial structures that are more water-bearing (see also Section 4.7.1). These structures have been observed above all in superficial rock and were probably formed due to destressing, and they are interconnected to differing degrees to other horizontal fractures and to the deformation zones.

The most significant remaining uncertainty in the geology at SFR concerns the occurrence, size and properties of subhorizontal structures in the bedrock nearest the ground surface (SKB 2013e).

The combined model with both deformation zones and rock domains, which indicates rock type composition, is shown in a 3D view in Figure 4-40. This figure also shows the location of SFR 1. SFR 3 will be on a level with the deepest parts of SFR 1, in the Central Block to the southeast of SFR 1 (see Figures 4-1 and 4-3).

#### 4.6.4 Rock mechanical conditions

The mechanical properties of intact rock in the rock types occurring in the area can be described by means of rock mechanical parameters. An estimate of the expected range of three common parameters (uniaxial compressive strength, tensile strength and Young's modulus) is given in Table 4-8. It should be noted that the rocks can be classed as R5 (Very strong) to R6 (Extremely Strong) using the ISRM Strength Classification (Brown 1981).

When it comes to assessment of mechanical properties, subhorizontal superficial fractures (0–50 m) have been described in a category of their own, since their properties are expected to differ from those of other fractures (inclination/dip and depth). Table 4-9 provides approximate values of mechanical parameters for single fractures.

A common way to characterise the properties of a rock mass is to estimate strength with a Mohr–Coulomb material model and deformation properties with elastic parameters. Table 4-10 gives typical values of these rock mechanical parameters for the rock mass in SFR, both in the rock domains, i.e. in the “normal” fractured rock, and in the deformation zones. The properties in the deformation zones are expected to differ between the core and the outer parts (transition zone towards the less influenced rock mass), although many of the minor zones are not expected to have any pronounced core.

**Table 4-8. Rock mechanical parameters of intact rock in the SFR area (SKB 2013e, Table 6-3). (Given in the form of a truncated normal distribution: mean/standard deviation and min-max).**

Parameter	101057 – Granite to granodiorite	101061 – Pegmatite, pegmatitic granite	111058 – Fine- to medium-grained granite	103076 – Felsic to intermediate metavolcanic rock	102017 – Amphibolite
Uniaxial compressive strength (MPa)	226/50 126–326	183/45 90–270	280/45 210–350	139/45 100–200	142/45 60–230
Indirect tensile strength (Brazilian test) (MPa)	13/2 10–18	12/3 8–16	16/2 12–20	9/2 5–13	9/2 5–13
Young's modulus (GPa)	75/3 69–81	74/4 66–82	74/2.5 70–79	99/3 93–105	81/4 73–89

**Table 4-9. Expected mechanical properties of single fractures in the SFR area (SKB 2013e, Table 6-6).**

Parameter	Subhorizontal (dip 0–20°) fractures with a depth z = 0–50 m, $\sigma_n'$ = effective normal stress	Other fractures with a depth z = 0–150 m and Subhorizontal fractures where z > 50 m, $\sigma_n'$ = effective normal stress
Normal stiffness, $K_n$ [MPa/mm]	$K_n = 10 \times \sigma_n'$	$K_n = 10 \times \sigma_n'$
Shear stiffness, $K_s$ [MPa/mm]	$K = K_n / 3$	$K = K_n / 20$
Friction angle, $\phi_1$ [°] for normal stress range 0–0.5 MPa	66°	48°
Friction angle, $\phi_2$ [°] for normal stress range 0.5–1.5 MPa	32°	35°
Apparent cohesion for normal stress range 0.5–1.5 MPa	0.4	0.4
Dilatancy	15°	15°



**Table 4-10. Typical values of strength and deformation properties in rock domains and deformation zones. The Mohr–Coulomb material model has been assumed. Data for depth of 20–150 metres (SKB 2013e, Tables 6-8 and 6-9).**

	Friction angle, M-C (0–5 MPa)	Cohesion, M-C (0–5 MPa)	Deformation modulus for the rock mass, Em	Poisson's ratio
Rock domain	50–60°	13 MPa	50 GPa	0.34
Outer part of deformation zone	51°	2 MPa	13 GPa	0.35
Core of deformation zone	37°	2 MPa	2.6 GPa	0.45

Since no direct measurements of the rock stress have been made in the area where the SFR 3 is planned to be located, it is difficult to estimate the rock stress with any certainty. Furthermore, a greater variation in rock stresses can be expected in the most superficial rock. The estimate that has been made (Table 4-11), based on measurements made in the SFR area, must therefore be regarded as uncertain. The stress magnitudes will, however, in all probability be relatively low at repository level, and are not expected to be a significant factor for constructability or safety. The dominant orientation of the principal stress is judged to be relatively well known.

Adjacent to the excavated tunnels and waste vaults, the stresses will be redistributed so that they differ somewhat from the *in-situ* stress given above. There is expected to be an excavation-damaged zone (EDZ) outside the tunnel walls caused by the blasting. The fracture frequency in the EDZ is slightly higher than in the surrounding rock. The extent of the EDZ is expected to be very limited, on the order of < 0.3 m from blasted surfaces.

**Table 4-11. Rock stresses with depth dependence in the SFR area from the rock surface down to a depth of 250 metres (z is the depth in metres) (SKB 2013e, Table 6-11).**

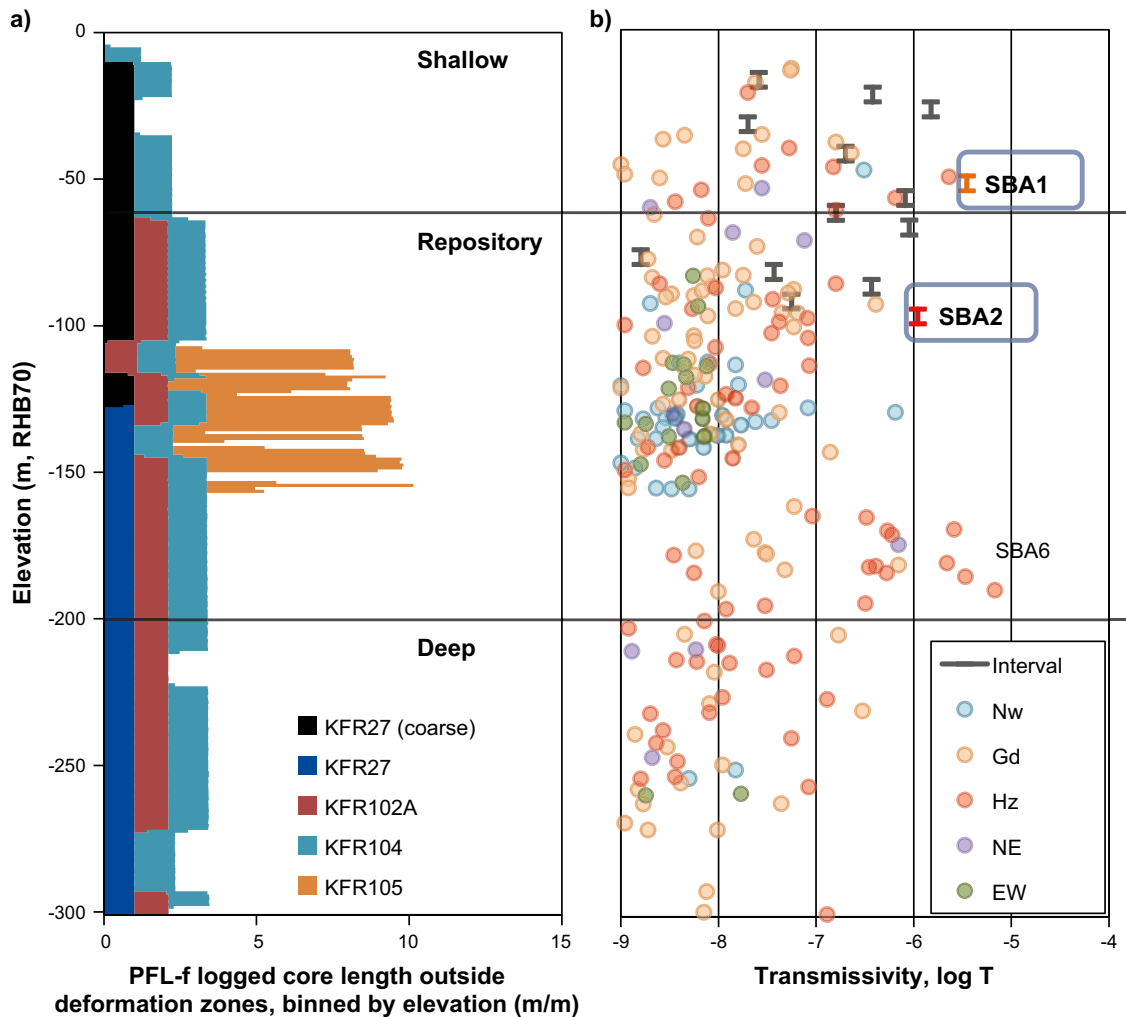
All rock domains	Major horizontal stress	Minor horizontal stress	Vertical stress
Magnitude (MPa)	$\sigma_H = 5 + 0.07z$	$\sigma_n = 0.07z$	$\sigma_v = 0.065z$
Orientation (trend from north)	142°	52°	Vertical

## 4.7 Hydrogeology

### 4.7.1 Hydraulic conductivity of the rock

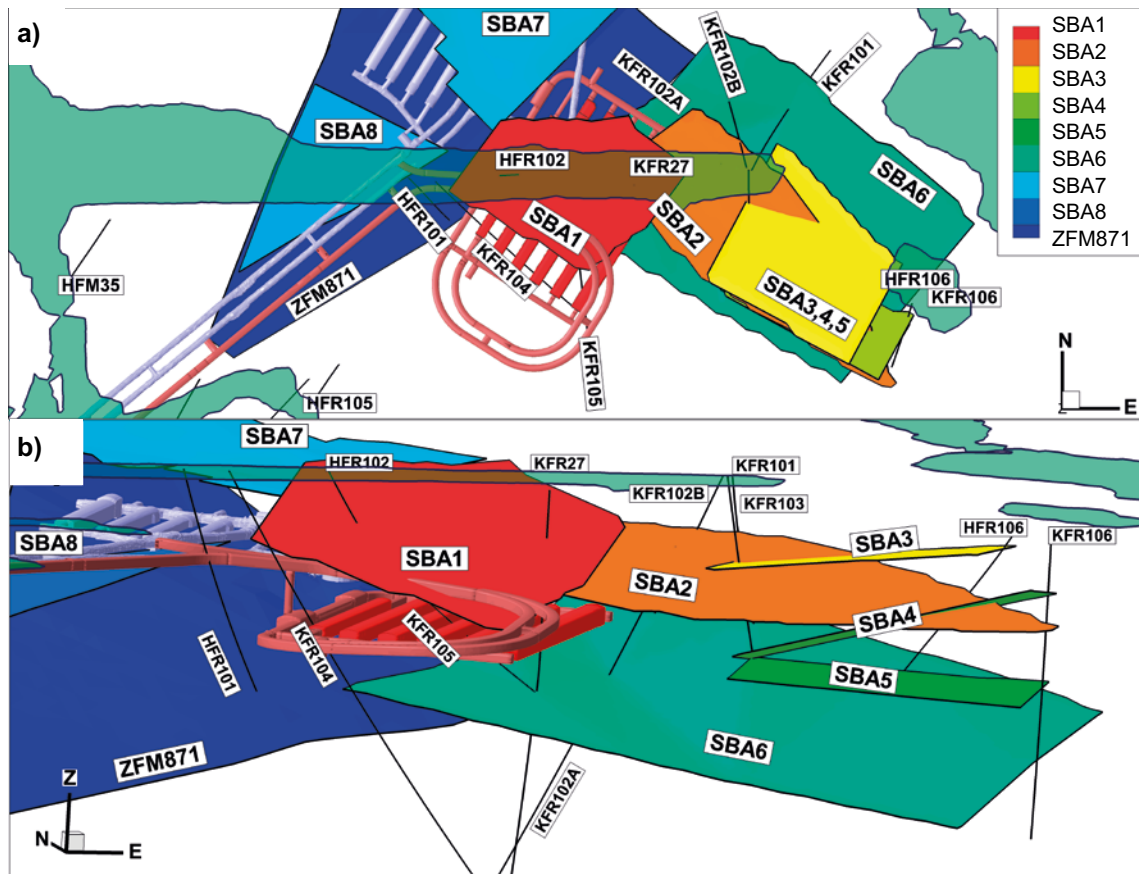
The rock at SFR is a fractured crystalline rock. The groundwater flow takes place in connected open fractures. The hydraulic conductivity of the rock is dependent on the geometric and hydraulic properties of these fractures.

A total of 12 boreholes have been drilled in preparation for SFR 3, and fracture mapping surveys and hydraulic tests have been performed in the boreholes. A detailed description of the investigations and analysis of the geometric and hydraulic properties of the fractures is provided in the Site Descriptive Model of the SFR area, SDM-PSU (SKB 2013e). An account is given there of the frequency of water-bearing (transmissive) fractures in deformation zones and in the rock mass between them. One of the observations in SDM-PSU is that the most transmissive fractures down to 200 m have been encountered in the rock mass between modelled deformation zones. Another observation is that gently dipping fractures are the most transmissive, even inside the steeply dipping deformation zones. Among the steeply dipping fracture sets, it is the NW-SE set that is the most transmissive. In the area planned for SFR 3, the frequency of transmissive gently dipping fractures is lower in the interval 100–150 m than it is above or below this depth interval, see Figure 4-41.



**Figure 4-41.** a) Borehole coverage (total borehole length) in the area closest to SFR 3, and b) PFL-f and PSS transmissivity data (in interval) outside deformation zones divided into fracture sets (Nw, Gd = Gently dipping, Hz = Horizontal, NE and EW). SBA stands for Shallow Bedrock Aquifer (for explanation, see text). The depth interval 100–150 m contains fewer highly transmissive fractures than the interval 50–100 m.

There are three subhorizontal superficial structures in Figure 4-41, so-called SBA structures: SBA1, SBA2 and SBA6. In SDM-PSU, a total of eight SBA structures (SBA1-SBA8) have been modelled, see Figure 4-42. The abbreviation SBA stands for *Shallow Bedrock Aquifer* and was used in SDM-PSU to describe the fact that there are sections with an elevated frequency of gently dipping fractures in the rock mass between the geologically modelled steeply dipping deformation zones. The SBA structures are linked together into a persistent fracture network by steeply dipping fractures (see Öhman et al. 2012, Appendix H). Besides local data on the permeability of the network structures, hydraulic responses between boreholes have also been utilised in the modelling of SBA structures.

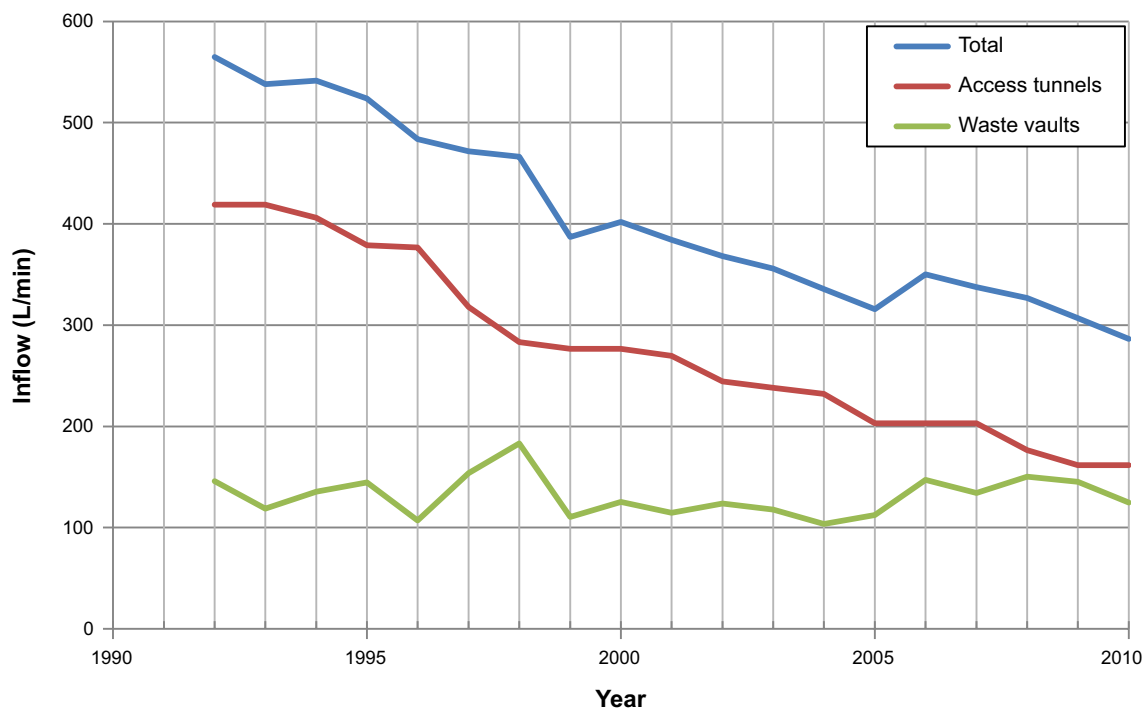


**Figure 4-42.** Visualisation of eight SBA structures and the gently dipping deformation zone ZFM871 (previously designated Zone H2) as well as SFR 1 (blue) and SFR 3 (red): a) view from above and b) view towards the northeast. The relevant boreholes are designated by their KFR and HFR numbers: KFR = cored boreholes; HFR = percussion boreholes.

#### 4.7.2 Groundwater inflow

The total quantity of groundwater inflow that is continuously pumped out of SFR 1 has been monitored since January 1988 when the facility was commissioned. From 720 L/min initially, the groundwater inflow rate has declined after about 25 years to about 250 L/min (excluding the open part of the access tunnels). The quantity of water that leaves the facility with the ventilation air is not measured, but is considerably lower.

Figure 4-43 shows a compilation of measured drainage flows between 1992 and 2010, broken down into access tunnels and waste vaults. It can be seen from the compilation that the inflow to the waste vaults has been more or less constant since 1992, whereas the inflow to the access tunnels has decreased continuously. The reduced inflow indicates that the hydraulic connection with the sea above SFR 1 is limited and that the system of water-bearing gently dipping fractures in the rock is being emptied. This interpretation is supported by the observation that the groundwater levels in the rock closest to SFR are also declining continuously.



**Figure 4-43.** Inflow to SFR 1. The red curve (access tunnels) and the green curve (waste vaults) constitute fractions of the total inflow (blue curve).

## 4.8 Groundwater chemistry

The hydrochemical conditions in the bedrock are described in the Site Descriptive Model for the SFR area, SDM-PSU (SKB 2013e) and in Nilsson et al. (2011). A summary description of the water chemistry in bedrock groundwaters follows in this section, whereas near-surface groundwaters (in the overburden) are commented on in Section 4.5.2.

The hydrochemical sampling done in the site investigations for SDM-PSU has yielded data from a total of fifteen borehole sections in five cored boreholes and three percussion boreholes. Furthermore, the SICADA database contains data from two percussion boreholes from the site investigation in Forsmark for the spent fuel repository (Laaksoharju et al. 2008) and from a total of 45 borehole sections in 18 older cored boreholes drilled from the existing tunnels in SFR 1 (Nilsson et al. 2011).

### 4.8.1 Present groundwater composition and their origins

The SFR groundwaters show some characteristic features. The chloride concentration range is small (1,500 to 5,500 mg/L Cl<sup>-</sup>) compared with the Forsmark site (50 to 16,000 mg/L Cl<sup>-</sup>). This occurs although the δ<sup>18</sup>O values (an indicator of water origin) show similar variation (-15.5 to -7.5‰ V-SMOW), see Figure 4-44. Furthermore, marine indicators, such as Mg<sup>2+</sup>/Cl<sup>-</sup>, K<sup>+</sup>/Cl<sup>-</sup> and Br<sup>-</sup>/Cl<sup>-</sup> ratios also show relatively large variations, especially considering the limited salinity range. This suggests the presence of groundwaters with different origins.

From measured Eh values – and in accordance with the redox chemistry for iron, manganese, sulphur and uranium – it can be concluded that weakly reducing conditions (-140 to -190 mV) prevail generally in the investigated groundwaters, also in young groundwater with a significant component of Baltic Sea water (Nilsson et al. 2011). The redox-buffering capacity consists of fracture-filling iron(II) minerals which cover the conductive fractures and which, in SFR, mainly consist of chlorite, clay minerals and pyrite (Sandström and Tullborg 2011, Sandström et al. 2013).

Of great importance for the understanding of the present-day groundwater chemistry at SFR is the evolution of today's "Baltic Sea" area during Weichselian and Holocene times (Westman et al. 1999, SKB 2008b). Before the intrusion of meltwater from the last deglaciation, it is assumed that old meteoric waters from both temperate and cold climate events were present. These waters were then mixed with glacial meltwater during the deglaciation since the bedrock was under high pressure, which made a larger number of fractures conductive and also increased the conductivity in the larger fractures/fracture zones. This facilitated downward transport of dilute melt water. During the subsequent Littorina Sea stage the higher density brackish seawater entered some of the deformation zones and fractures previously infiltrated by meltwater, and mixed with or displaced the resident fresh water of glacial and meteoric character. Other fracture systems were closed at the time due to a changed pressure situation. Therefore, trapped non-marine groundwater with a significant glacial component still resides in this less fractured bedrock. Table 4-12 summarises the different groundwater origins and their approximate residence times. The table includes also Baltic Sea water which is, most probably, a modern component that has entered due to the drawdown caused by the SFR 1.

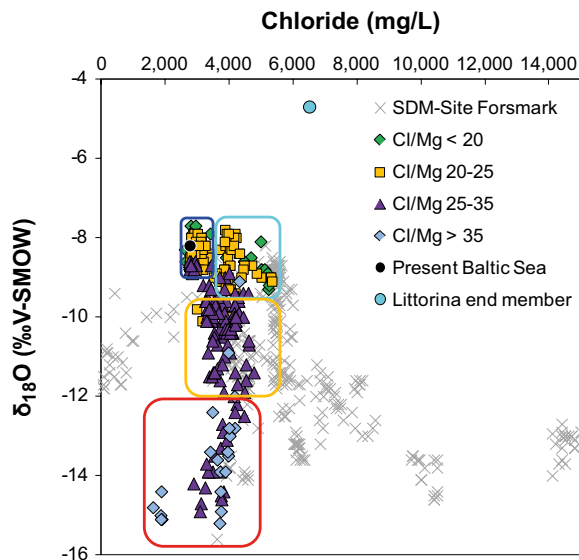
### **Groundwater types identified in SFR 1**

Four different types of groundwaters have been defined considering the paleoclimatological history of the Holocene (Westman et al. 1999); Local Baltic, Littorina with a glacial component, Brackish-glacial and Mixed-brackish (transition type). These groundwater types reflect the main origin of the groundwater but also changes (mixing and reactions) that occurred after the intrusion to the bedrock. The subdivision into these typical types of groundwater has been based on the chemical variables chloride, magnesium and  $\delta^{18}\text{O}$ . These variables can be used as indicators of the water's origin. Magnesium and  $\delta^{18}\text{O}$  vary depending on whether the water has a marine or glacial origin, whereas the variation in salinity is relatively small between these waters.

A plot of  $\delta^{18}\text{O}$  versus chloride concentration with categorisation according to Cl/Mg weight ratio and boxed areas signifying different groundwater types is displayed in Figure 4-44. The composition of the groundwater types, as well as reactions and processes that have influenced their chemistry, is presented in Table 4-13.

**Table 4-12. Origin and approximate residence time of groundwaters (SKB 2013e, modified from Table 8-2).**

<b>Origin</b>	<b>Approximate residence time</b>
Baltic Sea water	Modern water from the last 50 years based on tritium.
Littorina Sea water	The Littorina maximum extent occurred between 6,500 and 5,000 years ago.
Glacial meltwater	Most probably from the last glaciation about 11,000 years ago.
Brackish non-marine water	Older than the last deglaciation (> 15,000 years ago).
Saline deep water	Older than the last glaciation with components probably much older (hundreds of thousands of years). This water is not identified in the present-day SFR samples but is assumed to be present at depth below 700 m based on experience from the Forsmark site.



**Figure 4-44.** Plot of  $\delta^{18}\text{O}$  (‰ V-SMOW) versus chloride concentration. The SFR data are from the period 1986–2010. The figure shows the groundwater samples categorised according to the Cl/Mg weight ratio, and the boxed areas signify different groundwater types (see Table 4-13). There is continuous mixing between the groundwater types Local Baltic and Littorina with a glacial component and the boundary is set at a chloride concentration of 3,500 mg/L.

**Table 4-13. Groundwater types in SFR – composition, reactions/processes and origin (SKB 2013e, modified from Table 8-1).**





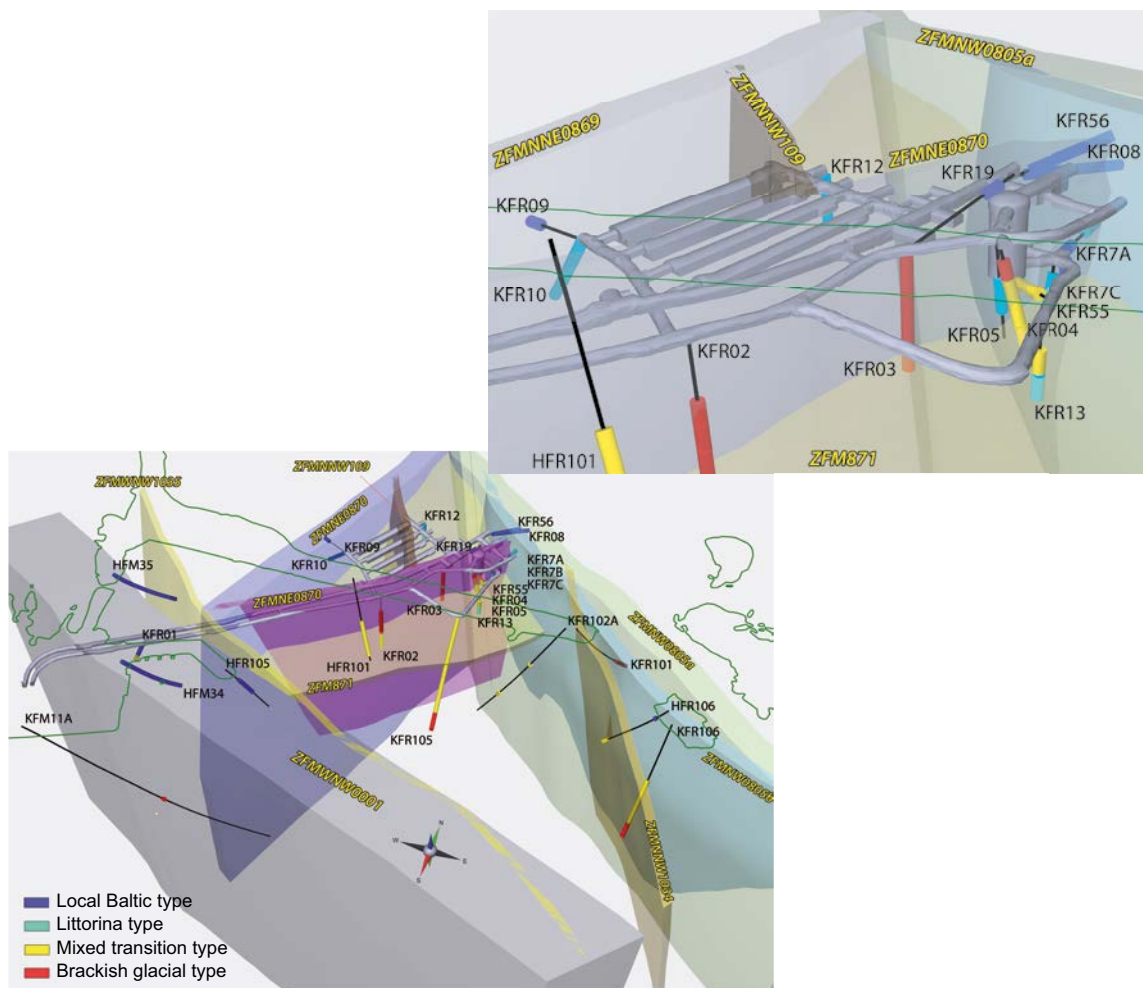
Groundwater type	Composition/ characteristics	Dominant reactions and processes	Origin
Local Baltic 	Chloride 2,500–3,500 mg/L $\delta^{18}\text{O}$ –9 to –7.5‰ V-SMOW Na-(Ca)-(Mg)-Cl-SO <sub>4</sub> type Cl/Mg weight ratio < 27	Ion exchange and microbiological reactions in the bedrock have resulted in decreased concentrations of Mg <sup>2+</sup> , K <sup>+</sup> , Na <sup>+</sup> and SO <sub>4</sub> <sup>2-</sup> as well as enrichment of Ca <sup>2+</sup> and HCO <sub>3</sub> <sup>-</sup> compared with Baltic Sea water.	It is unclear whether the Baltic Sea water was present at all in the deformation zones before the construction of the tunnels in SFR. It is more probably a modern component that has been introduced due to the drawdown caused by tunnels.
Littorina with a glacial component 	Chloride 3,500–6,000 mg/L $\delta^{18}\text{O}$ –9.5 to –7.5‰ V-SMOW Na-Ca-(Mg)-Cl-SO <sub>4</sub> type Cl/Mg weight ratio < 27	The Na/Ca ratio is lower than the marine ratio. These changes are caused by ion exchange, but also by dilution with glacial meltwater.	Compared with the original Littorina water, it has been diluted (lower Cl <sup>-</sup> and $\delta^{18}\text{O}$ values) with glacial meltwater.
Brackish-glacial 	Chloride 1,500–5,000 mg/L $\delta^{18}\text{O}$ < –12.0‰ V-SMOW Na-Ca-Cl type Cl/Mg weight ratio > 32	An old mixture of different, mainly non-marine groundwaters.	This is the oldest groundwater type and the amounts of post-glacial components are very small. It is a mixture of primarily glacial meltwater (last deglaciation or older) and brackish non-marine water (pre-glacial). It probably contains components of old meteoric water prior to last deglaciation as well.
Mixed-brackish (transition type) 	Chloride 2,500–6,000 mg/L $\delta^{18}\text{O}$ –12.0 to –9.5‰ V-SMOW Na-Ca-(Mg)-Cl-(SO <sub>4</sub> ) type	Natural or artificial mixing of the three different groundwater types above.	Significant mixing of the brackish-glacial and the two brackish marine groundwater types (mostly the Littorina type) has caused this ground water of transition type. It is more common during the last two decades, according to data from long time series which suggests artificial mixing due to the presence of the repository.

Figure 4-45 displays a 3D presentation of the SFR site, the boreholes, the groundwater types and the deformation zones. The hydrostructural properties of the SFR site determine the distribution and the degree of mixing of the different groundwater types. The Littorina type is observed primarily along vertical deformation zones with high hydraulic conductivity, with the propagation of the Local Baltic type expanding downwards in basically the same zones. The oldest groundwater type at the SFR site (Brackish-glacial) is present in bedrock with low conductivity located above and below subhorizontal/ horizontal, highly conductive structures/zones. Processes of mixing, resulting in the so-called Mixed-brackish (transition type) of groundwater, are occurring mainly along, and in the vicinity of, these conductive structures, for example in and close to horizontal zone ZFM871 (formerly zone H2).

During the period when the glacial meltwater penetrated downward, the bedrock was under high pressure, which means that both more and larger fractures were available, which facilitated the downward transport of water. The fractures closed when the pressure diminished, resulting in these relatively deeply lying zones where the glacial meltwater has been mixed with brackish non-marine water, forming water with low chloride contents.



**Figure 4-45.** 3D presentation, viewed from above and from the southeast, of the groundwater type distribution in relation to the major zones in the regional model volume. The SFR boreholes are enlarged in the upper figure. The green outline at the surface demarcates the shoreline with the pier and small islet.

## 4.8.2 Groundwater types in the area for SFR 3

Fewer data are available from the area for SFR 3 than from the area for SFR 1, and data from the central part of SFR 3 are lacking entirely. In general, the majority of the deeper sections in the investigated boreholes are characterised by various proportions of glacial meltwater (brackish-glacial groundwater type), whereas the groundwater type Mixed-brackish (transition type) is most prevalent at shallower levels (see Figure 4-45; KFR105). It can be noted that no waters of Littorina type and only a few waters of Local Baltic type have been encountered in these investigated borehole sections.

## 4.8.3 Changes in water composition caused by drawdown in SFR

In general, mixing takes place mainly in and near the deformation zones – between Littorina type and Local Baltic type groundwater, and between Brackish-glacial type and Littorina type groundwater, the latter forming the Mixed-brackish (transition type) groundwater. The distribution of the different groundwater types shows that the major deformation zones have acted as flow paths for groundwater during long geological periods and still act as efficient pathways, whereas fractures in less conductive bedrock between these zones generally retain old, more isolated groundwaters.

Measurement series in boreholes and tunnel systems show that the chloride content declined between years 1986 and 2000, followed by a nearly stable period up to year 2010 (SKB 2013e). This is expected, since the greatest changes with regard to groundwater pressure and inflows to the boreholes and the tunnel system occurred soon after construction. During the construction and operation of SFR 3, mainly the same pattern in groundwater chemistry can be expected as in SFR 1, with an increasing occurrence of the local Baltic Sea and Mixed transition groundwater types. However, no Littorina Sea type groundwater has been encountered, which indicates lack of efficient flow paths, therefore intrusion of modern Baltic Sea water will probably be less pronounced in SFR 3 compared with the existing SFR. This may imply that the rate of changes will be slower in SFR 3.

However, the observed changes in SFR 1 indicate that the future impact of SFR 3 on the groundwater chemistry may occur in a relatively short time perspective. A few positive Eh values have been measured, most of them in year 2000. It is possible that they may be linked to the presence of amorphous Fe(III) oxyhydroxides (Gimeno et al. 2011), but it is more probable that they are due to the influence of an open repository (and/or that the time required for making adequate redox measurements was not allocated). More recent and repeated measurements show reducing conditions. Furthermore, in a supplementary study (Sandström et al. 2013), minerals interpreted as Fe(III) oxyhydroxides were re-evaluated and found to be iron-rich layered clay minerals, uranium-minerals, hematite-stained adularia and albite or even rust-coloured metallic iron from the drilling process.

Although it has not been proven, it is quite possible that the groundwater flow path from the mainland Forsmark, may supply shallow groundwater. Potentially, this groundwater can contribute to a mixing between groundwater of meteoric origin and water originating from the Littorina Sea. However, the composition of this mixture cannot, at present, be distinguished from that of Baltic/Littorina mixtures.

## 4.8.4 Water composition in the initial state

The composition of penetrating brackish saline groundwater is given in Auqué et al. (2013), see Table 4-14. The composition is based on weighted values for all groundwater types occurring in SFR with broad intervals. The redox value (Eh) is based on modelled values and on the measured values reported in Section 4.8.1. It is likely that the Eh will stay at today's value or even decline, since the dissolved oxygen in the groundwater will be rapidly consumed as the tunnels fill with water.

When the repository is water-filled, reactions will also occur with the concrete in the structures in SFR. The pH in the pore water in the concrete is around 13, and when the repository has become water-saturated, hydroxide ions from the concrete's pore water will contribute to an increase of the pH in the water in the repository. During the sampling period 1986 to 2010, a slightly rising trend in the groundwater pH can be seen, but the range of measured values is large.



**Table 4-14. Composition of penetrating brackish/saline water and range of variation of the relevant parameters during the temperate climate domain when the repository is situated beneath the surface of the sea. Concentrations in mg/L (Auqué et al. 2013, Tables 4.1 and 4.2). Data from an earlier safety assessment are shown for comparison.**

	Composition	Range of variation Samples from SFR down to –200 m	Earlier safety assessment SFR 1 (Höglund 2001)
pH	7.3	6.6–8.0	7.3 (6.5–7.8)
Eh	–225	–100 to –350	Red. (–100 to –400)
Cl	3,500	2,590–5,380	5,000 (3,000–6,000)
SO <sub>4</sub> <sup>2-</sup>	350	74–557.2	500 (20–600)
HCO <sub>3</sub> <sup>-</sup>	90	40–157	100 (40–110)
Na	1,500	850–1,920	2,500 (1,000–2,600)
K	20	3.8–60	20 (6–30)
Ca	600	87–1,220	430 (200–1,600)
Mg	150	79–290	270 (100–300)
SiO <sub>2</sub>	11	2.6–17.2	5.66

### **Uncertainties**

A large amount of data on the groundwater composition is available, which minimises the risk of error in single points, and as far as uncertainties in time are concerned, there are enough data to see trends. The spatial distribution, on the other hand, is uneven since there are many sampling points in SFR 1, while there are fewer in the area for SFR 3 and none in the central part of SFR 3. However, predictability with regard to the expected composition of the groundwater is good, and it is not probable that any extreme water compositions other than those already encountered will be discovered during the construction phase.

The undisturbed hydrochemical conditions prevailing before the construction of SFR 1 are not known, since there are no groundwater chemistry data available before the construction of SFR 1, and this adds to the uncertainty.

Site-specific aspects of the groundwater regarding pore water, microbes and gases were not studied in the site investigations for SDM-PSU (SKB 2013e). SFR data on organic matter (DOC, TOC) are also relatively few. Some interpretations and knowledge from the Forsmark site, SDM-Site Forsmark (Laaksoharju et al. 2008, SKB 2008b) are considered applicable and relevant also for SFR.



## 5 Safety functions

The safety functions describe long-term functioning of the repository and its components and are an aid in the formulation of scenarios. This chapter presents how the selection and description of the safety functions has been made based on the overall long-term safety principles described in Section 2.1.2.

Safety assessment (see Section 2.3) depends on knowledge of the future evolution and is described in the following three areas; 1) Initial state, 2) Internal processes, and 3) External conditions. From these areas of knowledge, a set of safety functions can be defined and they describe how any repository component contributes to the long-term safety.

In order to evaluate how a safety function influences the long-term safety of the repository, each safety function should be associated with one or several measurable or calculable quantities, so called safety function indicators.

The use of safety functions and indicators is an aid in the evaluation of safety but is not sufficient to demonstrate that an acceptable level of safety has been achieved. Nor is safety necessarily compromised if a safety function is violated, this is rather an indication that more in-depth analyses are needed to evaluate safety. Quantitative calculations are required to show compliance with the risk criterion irrespective of whether none, one or several safety functions are violated.

The long-term safety of SFR is achieved by limiting the activity of long-lived radionuclides disposed in the repository and ensuring that the transport of radionuclides from the waste, through the engineered barriers and through the environs of the repository is sufficiently retarded. The overall long-term safety principles for SFR are therefore formulated as *limitation of the activity of long-lived radionuclides* and *retention of radionuclides* (see Section 2.1.2). The content of long-lived radionuclides in the waste is limited by only accepting for disposal certain kinds of waste. Slow outward transport of radionuclides is achieved by ensuring a low water flow rate through the waste and the engineered barriers, through each waste vault and through the repository, and by retarding radionuclide transport relative to this water flow. This retardation is achieved mainly by ensuring effective sorption.

In accordance with the applicable methodology (Section 2.4), the safety principles are broken down into safety functions specified for the waste and the repository components. Aspects that need to be considered according to the **Initial state report** have also been taken into account in the selection of safety functions.

The safety functions and safety function indicators are used in selection and description of the main scenario and the less probable scenarios that are analysed to evaluate the radiological safety of the repository, see Chapter 7.

Safety functions were used in the previous safety assessment for SFR, SAR-08 (SKB 2008a). Experience from SAR-08 as to the appropriateness of the use of a methodology based on safety functions was good, which was also confirmed by SSM in its review of the safety assessment (SSM 2009):

*“SKB bases SAR-08 on safety functions similar to those used in SR-Can. SSM believes that this is a suitable methodology, since it creates clarity regarding performance requirements for different components and makes it easier to focus the assessment on safety-critical matters”.*

However, other review comments made by SSM suggested that the choice and justification of safety functions and associated indicators could be improved. This has been considered in the present assessment.

Safety functions and safety function indicators are also used in other applications e.g. siting process; this is discussed briefly in Section 5.6.

## 5.1 Safety functions as a basis for scenario description

The future evolution of the repository and its environs is of central importance in an assessment of the repository's long-term safety. The basis of the description of this evolution is the reference evolution presented in Chapter 6. Uncertainties in the future evolution of areas of importance for the repository's long-term safety are handled by means of alternative scenarios. The less probable scenarios are defined by positing that one of the safety functions is altered relative to its status in the main scenario (which is based on the reference evolution of the system) in such a way that a lower degree of safety is indicated. The scenario description comprises the cause (evaluated uncertainty in initial state, internal processes and/or external conditions), the time period when this happens and what parameter values are altered (deviation from the main scenario).

The performance of the repository components does not generally change in discrete steps. The repository will change continuously and there is no clear distinction between an acceptable and a deficient performance for the individual barriers. Therefore, no criteria for the safety function indicators have been defined in this assessment. The main purpose of the safety function indicators is to guide the choice and definition of scenarios. This has been done by comparing the state of the safety function indicator with what has been assumed in the main scenario. In principle, this means that alternative scenarios are generated by the fact that the safety function indicators deviate from the conditions in the main scenario.

## 5.2 Method for selecting safety functions

The overall post-closure safety principles *limitation of the activity of long-lived radionuclides* and *retention of radionuclides* may be broken down further to general safety functions for the repository, see Table 5-1.

Aspects that need to be considered according to the **Initial state report** are also used in the selection of safety functions, see Section 5.2.1.

The identification of safety functions for the safety assessment is based on the characteristics of the repository's sub-components from the perspective of long-term safety. Sections 5.3 and 5.4 describe how this identification is achieved.

The selected safety functions and the associated safety function indicators are summarised at the end of each section. Table 5-3 summarises all selected safety functions and the associated safety function indicators.

### 5.2.1 Repository components and their functions

Having clear quality procedures for construction of barriers and other components in the repository system as well as stringent waste acceptance criteria and associated type descriptions for the wastes reduces uncertainties in the initial state of the repository. The initial state is regarded as the starting point for the assessment of post-closure safety. The **Initial state report** *presents a description of the repository at the time of closure, structured according to needs for the assessment of long-term safety*. The report links together waste type description, repository design and the quality system that has been created to guarantee the starting point for the post-closure assessment. The **Initial state report** presents the different components in the repository and their functions, in accordance with Table 5-2.

However, some of these components functions are assured by means of various quality measures and it is therefore assumed that it is not necessary to define safety functions for all aspects extracted in the **Initial state report** for the purpose of analysing the component's importance for the long-term function of the repository and the formulation of scenarios.

**Table 5-1. Safety principles broken down into general safety functions.**

Safety principle	Breaks down into safety functions
Limitation of the activity of long-lived radionuclides	Limited quantity of activity
Retention of radionuclides	Low water flow
	Good retention
	Avoid wells in the direct vicinity of the repository

**Table 5-2. Potential aspects that are considered in the long-term safety analysis for the different components in some or all of the waste vaults (from the Initial state report).**

Component	Aspect
Waste form	Level of radioactivity Limited advective transport Mechanical stability Limited dissolution Sorption Favourable water chemistry
Waste packaging	Limited advective transport Mechanical stability Sorption Favourable water chemistry
Grouting surrounding waste packages	Limited advective transport Mechanical stability Sorption Favourable water chemistry
Concrete structures	Limited advective transport Mechanical stability Sorption Favourable water chemistry
Shotcrete	Mechanical stability (during operational phase, together with rock bolts) Sorption Favourable water chemistry
Bentonite and sand/bentonite	Mechanical stability Limited advective transport Sorption
Backfill in waste vaults (crushed rock/macadam)	Mechanical stability Sorption
Plugs and other closure components (investigation boreholes)	Limited advective transport in the repository Sorption

Internal processes of importance for the long-term safety of the repository are presented in the process reports that have been produced within SR-PSU (**Waste process report, Barrier process report, Geosphere process report**). The selection of processes that may be of importance is based on a systematic analysis of features, events and processes (a FEP analysis: **FEP report**). Among the processes presented in the process reports, the ones that are of significance for determining the importance of repository components for the long-term functioning of the repository and that help in the formulation of scenarios are singled out. However, just because a process is important for the assessment, does not mean that a corresponding safety function must be defined. Safety functions are defined to *clarify the importance of repository components for the long-term functioning of the repository and help in the formulation of scenarios*. An example is radioactive decay, which must be taken into account in an assessment of the repository's long-term safety and is included in the consequence calculations that are carried out. However, the uncertainty in the decay constant of critical radionuclides is judged to be small compared to other uncertainties (e.g. radionuclide inventory) and this is why no scenarios where the importance of decay constant uncertainties are studied.

### 5.3 Limitation of the activity of long-lived radionuclides

The overall safety principle *limitation of the activity of long-lived radionuclides* entails that the radioactive content in the waste deposited in SFR shall be specified and restricted within predefined limits. The safety principle takes account of the general SKB mission and is therefore to be seen in a wider perspective, including the roles of other facilities in the waste management program.

### 5.3.1 Allocation of waste to and distribution within the repository

Waste is allocated to and distributed within SFR in accordance with certain criteria, which are described in the disposal strategy (SKBdoc 1434623). In the existing facility, the quantity of activity in the over-all repository and in different waste vaults is regulated via a licensing condition issued by the former regulatory authority (SSI 2003).

The waste that is considered suitable for disposal in SFR is presented in an inventory report (SKB 2013a). The inventory report is based on data on already deposited operational wastes and estimates of future operational and decommissioning wastes. The reference inventory is based on the *best estimate*, with which uncertainties presented in the inventory report may be associated. Deviations from the reference inventory in each vault could influence the long-term safety of the repository.

#### **Selected safety functions and safety function indicators**

In recognition of the safety principle *limitation of the activity of long-lived radionuclides*, the safety function *limited quantity of activity* is defined to underscore the importance of the nuclide-specific inventory for the long-term safety of the repository. A relevant safety function indicator is:

- Activity of each radionuclide in each waste vault:
  - 1BMA,
  - 2BMA,
  - 1BTF,
  - 2BTF,
  - Silo,
  - 1BLA,
  - 2–5BLA,
  - BRT.

### 5.4 Retention of radionuclides

The overall safety principle *retention of radionuclides* applies to waste, engineered barriers in waste vaults, plugs, and the surrounding rock. Retention is achieved mainly by limiting advective transport and ensuring effective sorption.

Within the context of the disposal strategy discussed in Section 5.3.1, waste acceptance criteria are fundamental, and the specific properties of the waste packages are selected to minimise radionuclide release. Thus, the following discussion focuses first on requirements placed on the waste and waste packaging, before considering the engineered system, geosphere and biosphere.

#### 5.4.1 Function of waste and packaging

In the **Initial state report**, the waste and the waste packaging are defined separately. In the context of safety function, the waste and waste packaging are merged together and described as waste packages. The potential aspects connected to the waste packages ability to retain radionuclide are, according to Table 5-2:

- Limit advective transport.
- Ensure mechanical stability.
- Enhance retention by:
  - limit dissolution,
  - maximise sorption.
- Ensure a favourable water chemistry.

These characteristics control the release of radionuclides from the waste packages and out into the surrounding barriers.

**Limited advective transport.** For waste packages of low hydraulic conductivity, their hydraulic resistance, in combination with the surrounding barrier's hydraulic resistance, will limit the water flow. The limited flow of water through the waste packages should, in turn, ensure a slow release of radionuclides from them. In the case of the BLA vaults, there are no requirements regarding the hydraulic properties of the waste packages. The safety assessment does not credit the hydraulic resistance that can be attributed to the waste packages in BLA. Thus, the advective transport in BLA is limited by the flow resistance in surrounding barriers.

**Mechanical stability.** The mechanical stability of the waste packages is taken into account in the waste acceptance criteria and waste type descriptions and is further described in the **Initial state report**.

**Limited dissolution.** In the case of certain substances, the maximum concentration in the pore water may be solubility limited. This is particularly true if the substance has become concentrated in the pore water following degradation of the waste packages after closure. Examples of radionuclides whose concentration might be limited by solubility are C-14, Ni-59 and Ni-63 (see the **Waste process report**). Solubility limitations are, however, not taken into account in the present safety assessment, and no safety function is defined. Excluding solubility limitation is a pessimistic approach; the effect of it has been investigated separately.

The induced activity that is present in the reactor pressure vessels stored in the repository is released via corrosion, and the rate of release is controlled by the corrosion rate, which is dependent on the water chemistry (see below). This is taken into account in the safety assessment.

**Sorption.** Many radionuclides sorb to solid materials in the waste package, where the sorption capacity varies depending on the solid material and the pore water chemistry. This sorption limits concentrations of dissolved radionuclides in the pore water (see the **Waste process report**). Low concentrations of dissolved radionuclides in the pore water contribute to slow release from the waste, regardless of whether the transport is diffusive or advective. In principle, radionuclides can sorb not only to the concrete, cement or bitumen in the waste form, but also to ion-exchange resins, ashes, corrosion products, etc, as well as to waste packaging. The sorption properties of waste destined for disposal in the silo, BMA and BTF are determined by how the waste is conditioned. However, the safety assessment only credits sorption onto cementitious materials in the waste packages. In the case of the BLA waste packages only small amounts of cementitious material exist.

Sorption always takes place on solid surfaces. Cement has a relatively large porosity, and several of the solid phases of which cement consists are amorphous and have a large specific surface area, which favours sorption. With time, most of the solid phases in cement are slowly transformed into more crystalline substances, and a decrease in sorption capacity can be expected. As long as the cementitious materials are not chemically significantly altered, the pH in the pore water will be higher than 10.5, favouring the sorption of many radionuclides. This is described in detail in the **Waste process report**.

**Favourable water chemistry.** Sorption and dissolution are heavily dependent on the composition of the pore water (see the **Waste process report**). The most important parameters are:

- pH,
- redox potential,
- concentrations of complexing agents.

As long as the cementitious materials are not significantly chemically altered, the pH in the pore water will be high. This generally guarantees favourable sorption conditions for important cations. Anions are assumed to sorb poorly to cementitious materials in the entire relevant pH range.

The redox potential is an important parameter for sorption. For a repository such as SFR, it can be said that a low redox potential leads to a slower release of important radionuclides.

The waste also contains a certain amount of complexing agents (e.g. EDTA, NTA and citric acid) and, moreover, degradation of organic matter in the waste (particularly cellulose) can give rise to complexing agents. These agents can impact sorption by complexing with certain radionuclides in solution and reducing the degree of radionuclide sorption due to this change of chemical form. In

dissolved form, complexing agents could conceivably compete for radionuclide uptake with sorption to solid surfaces. Furthermore, complexing agents can bind radionuclides that are otherwise solubility limited. Therefore, concentrations of complexing agents need to be kept low.

Corrosion of reactor pressure vessels is limited by a high pH and a low redox potential.

### **Selected safety functions and safety function indicators**

In recognition of the safety principle *retention of radionuclides*, the safety function *good retention* in the waste packages is defined to underscore the influence of the waste packages on the long-term safety of the repository. The most important contributions to the safety function are made by sorption and limited release. The relevant safety function indicators are:

- the pH in the waste packages,
- the redox potential in the waste packages,
- the concentrations of complexing agents in the waste packages,
- the available sorption surface area in the waste packages.

For the BRT vault, the following safety function indicator is also defined:

- corrosion rate.

### **5.4.2 Function of the engineered barriers in the vaults**

The **Initial state report** presents the engineered barriers (the concrete structures and the bentonite in the silo), the embedment grout and the shotcrete separately. They are presented together in the following text. The following aspects of the engineered barriers are presented in Table 5-2 as being possible to take into account in the safety assessment.

**Limited advective transport.** Water flow in the interior of the vaults and through the waste packages should be limited. Two different approaches are used to achieve this. 1) The hydraulic contrast between the permeable macadam backfill surrounding the concrete structures and the less permeable concrete structures enclosing the waste packages diverts water flow away from the concrete structures to the more permeable surrounding materials (i.e a hydraulic cage). 2) The bentonite buffer surrounding the silo has a low hydraulic conductivity and will limit the water flow through the silo. However, there is a slight possibility that gas formed inside the silo will create an over-pressure that can violate this principle and expel water.

The hydraulic contrast is of importance for 1–2BMA and 1–2BTF, whilst the hydraulic conductivity is of importance for the silo.

**Mechanical stability.** The mechanical stability of the repository is taken into account in the design of the repository and is presented in the **Initial state report**. Lack of mechanical stability generally results in fractures being formed, changing the hydraulic conductivity in consequence. No specific safety function for long-term safety is linked directly to mechanical stability.

**Sorption.** The radionuclides released from the waste packages are retarded by sorption in the concrete grout surrounding the waste packages, the concrete structures and the macadam outside the concrete structures. In addition, radionuclides released to the connecting tunnels will be retarded by sorption on the materials in the plugs.

The greatest retention capacity for the radionuclides is found in cementitious materials (concrete walls, grout, etc) that have large specific surface areas, which favours sorption. It should, however, be noted that the safety assessment also credits retention in other materials in the repository (such as bentonite) in the radionuclide transport calculations. Since the quantity of cementitious materials is limited in 1BLA and 2–5BLA, no sorption is credited in these vaults.



**Favourable water chemistry.** Sorption is heavily dependent on the composition of the pore water (see for example the **Barrier process report**). The most important parameters are:

- pH,
- redox potential,
- concentrations of complexing agents.

As long as the cementitious materials are not chemically significantly altered, the pH in the pores will be higher than 10.5. This generally guarantees favourable sorption conditions for important cations. Anions are assumed to sorb poorly to cementitious materials in the entire relevant pH range.

The redox potential is an important parameter for sorption. For a repository such as SFR, it can be said that a low redox potential leads to a slower release of important radionuclides.

The wastes contain complexing agents (e.g. EDTA, NTA and citric acid), and moreover degradation of organic matter in the waste (particularly cellulose) can give rise to complexing agents. The complexing agents influence sorption in the barriers.

### **Selected safety functions and safety function indicators**

In recognition of the safety principle *retention of radionuclides*, two safety functions are defined. The first is *low flow in waste vaults* to underscore the hydraulic influence of the barriers on the long-term safety of the repository. The relevant safety function indicators are:

- hydraulic contrast (1-2BMA, 1-2BTF),
- hydraulic conductivity of bentonite (silo),
- gas pressure (silo).

The second safety function that is selected is *good retention* in concrete barriers. The most important contribution to this safety function is made by sorption. The relevant safety function indicators are:

- pH in concrete barriers (1-2BMA, 1-2BTF, silo, BRT),
- redox potential in concrete barriers (1-2BMA, 1-2BTF, silo, BRT),
- concentrations of complexing agents in concrete barriers (1-2BMA, 1-2BTF, silo),
- available specific surface area for sorption in concrete barriers (1-2BMA, 1-2BTF, silo, BRT).

### **5.4.3 Function of plugs and other closure components**

Aspects of plugs and other closure components that it is possible to take into account in the safety assessment are presented in Table 5-2. Plugs will be emplaced at strategic points in the tunnel system as a part of the repository closure. These plugs will consist of both concrete and bentonite components. Their main function is to limit the water flow in the waste vaults, but the plugs also contain material to which radionuclides can sorb. Although the concrete has a hydraulic function, it is subordinate to the hydraulic function of the bentonite. Processes that can alter the hydraulic function of the bentonite are described in the **Barrier process report**.

### **Selected safety functions and safety function indicators**

In recognition of the safety principle *retention of radionuclides*, the safety function *low flow in waste vaults* is defined to underscore the hydraulic influence of the plugs on the long-term safety of the repository. A relevant safety function indicator is:

- hydraulic conductivity of bentonite.

#### 5.4.4 Function of the geosphere

The geosphere has several functions from a long-term perspective.

**Low water flow to waste vaults.** A low water flow from the bedrock, through the waste vaults and back out into the bedrock is a prerequisite for slow transport of the radionuclides out of SFR. This applies in particular to non-retarded radionuclides. Low water flow to the waste vaults is also a prerequisite for slow inward transport of reactive substances such as oxidants.

Compared with the surrounding rock, the waste vaults are permeable, even when the waste vaults are backfilled with macadam. The flow that can arise in the waste vaults is therefore determined by the flow in the surrounding bedrock. The exception is the silo, where the surrounding bentonite has a lower hydraulic conductivity than the surrounding rock. The flow through the geosphere is in turn determined by the hydraulic gradient and the hydraulic conductivity.

The site for SFR was chosen in part for the low hydraulic gradient of the geosphere. Today, when SFR is located beneath the sea, the general gradient is very low. However, the direction and magnitude of the gradient change due to shoreline displacement. After about 1,000–2,000 years, when the ground surface above the repository is expected to be above sea level, the hydraulic gradient in the geosphere is expected to be significantly higher. Deviations from the general gradient are then expected to be controlled more by the local, rather than the regional, topography.

The flow through the different waste vaults, with the exception of the silo, is closely related to the hydraulic conductivity that is determined by the transmissivity of the fractures in the rock, the connectivity of the fracture network, and how this network is interconnected in the repository area. These quantities can be changed by e.g. an earthquake (see the **Geosphere process report**).

**Favourable water chemistry.** Sorption of many elements – such as Tc, Pu, U, Np and Se – is sensitive to the redox conditions in the repository. Sorption of these elements under oxidising conditions can differ considerably from sorption under reducing conditions. The redox conditions in the repository are determined by the composition of inflowing groundwater and the corrosion of materials inside the repository.

#### **Selected safety functions and safety function indicators**

In recognition of the safety principle *retention of radionuclides*, two safety functions are defined. The first is *low flow in bedrock*, which has been selected to underscore the function of the geosphere as a flow barrier. The relevant safety function indicators are:

- hydraulic gradient,
- hydraulic conductivity in bedrock.

The second safety function is *good retention*, which is controlled by reducing conditions at repository depth. The relevant safety function indicator is:

- redox potential.

#### 5.4.5 The surface system

An important safety feature of SFR is its location beneath the Baltic Sea. The surface of the repository will be covered with sea water for the first 1,000–2,000 years as discussed in Section 5.4.4. In addition to the beneficial hydraulic features, the external condition to have a sub-sea location of the repository also prevents humans locating wells above or downstream of the repository.

Due to shoreline displacement, the surface component will change over time and the long-term safety analysis takes into account the change.

**Wells.** Wells intended for drinking water or agricultural purposes may radically affect the radionuclide transport to the biosphere. The use and location of wells therefore influence the risk contribution, and this must be taken into account.

The location of the repository in relation to the shoreline is considered to be of crucial importance for the possibility of wells in the repository area or immediately downstream of the repository.

### **Selected safety functions and safety function indicators**

In recognition of the safety principle *retention of radionuclides* the safety function *avoid wells in the direct vicinity of the repository* is defined. The relevant safety function indicators are:

- intrusion wells,
- wells downstream of the repository.

## **5.5 Defined safety functions for the assessment**

The safety functions and safety function indicators that have been defined in this chapter are summarised in Table 5-3.

The following definitions are used:

- A safety function is a role by means of which a repository component contributes to safety.
- A safety function indicator is a measurable or calculable property of a repository component that is used to indicate the extent to which the safety function is fulfilled.

Data for safety function indicators describing the main scenario and the less probably scenarios are discussed in Chapter 7.

**Table 5-3. Safety functions and safety function indicators defined for SR-PSU.**

<b>Safety function</b>	<b>Safety function indicator</b>	<b>Component</b>
<b>Safety principle: Limitation of the activity of long-lived radionuclides</b>		
Limited quantity of activity	Activity of each radionuclide in each waste vault	Waste in 1BMA, 2BMA, 1BTF, 2BTF, silo, 1BLA, 2-5BLA and BRT
<b>Safety principle: Retention of radionuclides</b>		
Low flow in waste vaults	Hydraulic contrast	1-2BMA, 1-2BTF
	Hydraulic conductivity	Bentonite in silo and plugs
	Gas pressure	Silo
Low flow in bedrock	Hydraulic gradient	Geosphere
	Hydraulic conductivity	Geosphere
Good retention	pH	Cementitious materials in waste packages Concrete barriers in 1-2BMA, 1-2BTF, silo and BRT
	Redox potential	Cementitious materials in waste packages Concrete barriers in 1-2BMA, 1-2BTF, silo and BRT Geosphere
	Concentration of complexing agents	Cementitious materials in waste packages Concrete barriers in 1-2BMA, 1-2BTF and silo
	Available sorption surface area	Cementitious materials in waste packages Concrete barriers in 1-2BMA, 1-2BTF, silo and BRT
Avoid wells in the direct vicinity of the repository	Corrosion rate	Reactor pressure vessels BRT
	Intrusion wells	Surface system
	Wells downstream of the repository	Surface system

## 5.6 Additional use of safety functions

The safety functions and safety function indicators are used in the selection and description of the main scenario and the less probable scenarios. However, they can also be used for other purposes, e.g. siting, aid in defining design requirements, input to further technology development, or to formulate waste acceptance criteria.

As a part of the application to extend SFR, a siting study has been done where the selected site has been compared with alternative sites (SKB 2013b). The study used safety functions to evaluate the selected site against the alternative sites, see Table 5-4.

**Table 5-4. Safety functions of importance for siting.**

Safety function	Safety function indicator	Method for achieving safety function
Low flow in waste vaults	Low seismic activity	Siting (location in the country)
	Low risk of permafrost	Repository design (depth, location in the country)
Low flow in bedrock	Low seismic activity and avoidance of regional deformation zones	Siting (location in the country)
	Low hydraulic gradient in the bedrock	Siting (depth, location in the country)
	Low hydraulic conductivity in the bedrock	Siting (depth, location in the country)
Avoid inadvertent intrusion	Low risk of wells being drilled	Repository design (depth, location in the country)
	Low ore potential	Siting (location in the country)

## 6 Reference evolution

### 6.1 Introduction

This chapter describes the reference evolution, here defined as a range of probable future evolutions of the SFR repository system based on likely processes and events relevant for the long-term safety of the SFR repository. The purpose of the reference evolution is to provide an understanding of the overall future evolution of the repository system including the uncertainties of importance for the long-term safety of the repository. The initial state (Chapter 4), together with internal processes and external conditions that are likely to influence the evolution, serve as input to the reference evolution. The external conditions are determined by a set of climate cases defined in the **Climate report**, see Section 6.2, which represent the range of possible evolutions of climate and climate-related processes at Forsmark. Three climate cases representing prolonged interglacial conditions at Forsmark (**Climate report**), are included in the reference evolution. These include periods of temperate and periglacial climate conditions. The set of future climate developments analysed within the present safety assessment also includes a repetition of the reconstructed conditions for the past 120,000 years including periods of glacial climate conditions (the *Weichselian glacial cycle climate case*; see the **Climate report** Section 4.4). This climate case is given less focus in SR-PSU than in previous safety assessments for low- and intermediate-level waste (SAR-08) and for spent nuclear fuel (SR-Can, SR-Site). The motivation for this difference is summarised in Section 3.5.1, for a complete discussion see the **Climate report**.

The description of the reference evolution of the SFR repository and its environs has been divided into three parts. The evolution until around 1,000 years after closure during which the climate is expected to remain temperate and the engineered barriers are expected to retain their properties is described in more detail in Section 6.3. This early evolution is described in detail and is based on quantitative analyses as required in the regulation SSMFS 2008:37. During the remaining time until around 100,000 years after closure the climate is expected to change, the shoreline will be considerably displaced and the engineered barriers will degrade. The description of the evolution for this period has been divided into one part addressing the impact on the repository of processes likely to occur during temperate climate conditions (Section 6.4) and one part addressing the impact on the repository of processes likely to occur during periglacial climate conditions (Section 6.5). For each time frame, the evolution of the SFR repository system is presented in the following order:

- Evolution of surface systems.
- Thermal evolution.
- Mechanical evolution.
- Hydrogeological evolution.
- Near-field hydrological evolution.
- Geochemical evolution.
- Chemical evolution of the waste.
- Evolution of engineered barriers.

The description of the reference evolution is extensive and detailed. To get a general picture of the reference evolution it is possible to just read the summary, see Section 6.6. This section summarises the state of the repository system and its environs at 1,000 years after closure and at the end of the assessment period. Further, the state of the system around the time of the first occurrence of periglacial climate conditions in the two different climate cases is summarised.

The reference evolution is an important basis for the definition of a main scenario and less probable scenarios, as described in Chapter 7. The migration of radionuclides is not part of the reference evolution. Consequences of the assumptions made in the reference evolution on radionuclide release, transport and dose impacts are presented in Chapters 8–9.

## 6.2 External conditions

Climate and climate-related issues, such as shoreline displacement, are essential inputs to characterise the evolution of the repository. Climate is not predictable on a 100,000 year time scale. Therefore, *a range* of future climate developments must be considered in the safety assessment in order to cover the uncertainty in future climate development. This range is determined based on scientific knowledge on past, present and potential future climate evolution, as well as knowledge of the processes of importance for the function of the repository concept to be analysed.

In SAR-08 and in SR-Site, the reference evolution included two alternative future climate developments, a repetition of reconstructed conditions for the past 120,000 years and an evolution influenced by anthropogenic greenhouse-gas emissions. Current scientific understanding of the climate system suggests that the climate evolution for the coming 100,000 years will differ from the past climate variability. It is very likely that the anthropogenic release of CO<sub>2</sub> into the atmosphere, together with the future natural variation in insolation, will result in the present Holocene interglacial being considerably longer than previous interglacials. Based on current scientific understanding, the reference evolution in the present safety assessment is based on the assumption of anthropogenic greenhouse-gas emissions in combination with small variations in insolation resulting in a long period of temperate conditions in Forsmark. Three future evolutions of climate and climate-related issues, representing low, medium and high anthropogenic emissions of greenhouse gases (**Climate report**), are included in the reference evolution.

- The *global warming climate case*, representing a reasonable future climate evolution under the assumption of medium greenhouse gas emissions (**Climate report** Section 4.1).
- The *early periglacial climate case*, representing low anthropogenic emissions and a relatively fast decrease in atmospheric CO<sub>2</sub> concentration (**Climate report** Section 4.2).
- The *extended global warming climate case*, representing high anthropogenic emissions and a slow decrease in the atmospheric CO<sub>2</sub> concentration (**Climate report** Section 4.3).

The evolution of climate and climate-related issues in the climate cases are represented as climate-driven process domains (see the **Climate report** Section 1.3.2). The identified climate domains for Forsmark, a site on the Baltic Sea coast, are denominated:

- Temperate climate domain.
- Periglacial climate domain.
- Glacial climate domain.

The *temperate climate domain* is defined as regions without permafrost or the presence of ice sheets. It is dominated by a temperate Baltic Sea coast climate in a broad sense, with cold winters and either cold or warm summers. Precipitation may fall at any time of the year. The precipitation falls either as rain or snow. The temperate climate domain has the warmest climate of the three climate domains. Within the temperate climate domain, a site may also at times be submerged by the sea. Climates dominated by global warming due to enhanced atmospheric greenhouse gas concentrations are included in the temperate climate domain.

The *periglacial climate domain* is defined strictly as regions that contain permafrost. Furthermore, the periglacial climate domain is a cold region but without the presence of an ice sheet. In this climate domain, permafrost occurs either in sporadic (less than 50% spatial coverage), discontinuous (between 50 and 90% coverage), or continuous form (more than 90% coverage). Although true for most of the time, regions belonging to the periglacial climate domain are not necessarily the same as regions with a climate that supports permafrost growth. For example, at the end of a period with periglacial climate domain the climate may be relatively warm, not building or even supporting the presence of permafrost. Instead, permafrost may be diminishing. However, as long as permafrost is present, the region is defined as belonging to the periglacial climate domain, regardless of the prevailing temperature at the ground surface. This way of defining the climate domain is used because the presence of the permafrost is more important for the safety function of the repository than the actual temperature at the ground surface. In general, the periglacial climate domain has a climate colder than the temperate climate domain and warmer than the glacial climate domain. Precipitation may fall either as snow or rain. Within the periglacial climate domain, a site may also at times be submerged by the sea.

The *glacial climate domain* is defined as regions that are covered by glaciers or ice sheets. Within the glacial climate domain, the glacier or ice sheet may in some cases be underlain by sub-glacial permafrost. In line with the definition of the periglacial climate domain, areas belonging to the glacial climate domain may not necessarily at all times have a climate that supports the presence of ice sheets. However, in general, the glacial climate domain has the coldest climate of the three climate domains. Precipitation normally falls as snow in this climate domain.

The SR-PSU reference evolution, includes periods of temperate and periglacial climate domains. The glacial climate domain is not discussed further in this chapter, since it is not included in the reference evolution. The set of future climate developments analysed within the present safety assessment includes a repetition of the reconstructed conditions for the past 120,000 years including periods of the glacial climate domain (the *Weichselian glacial cycle climate case*; see the **Climate report** Section 4.4). As described in Section 3.5.1, this climate case is given less focus in SR-PSU than in previous safety assessments for low- and intermediate-level waste (SAR-08) and for spent nuclear fuel (SR-Can, SR-Site). The motivation for this difference is summarised in Section 3.5.1, for a complete discussion see the **Climate report**.

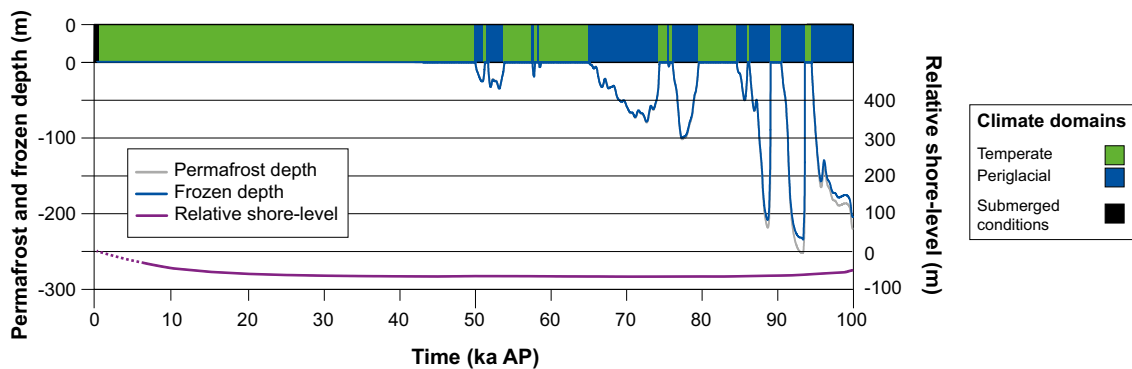
### 6.2.1 Timing of climate domains

The evolution of climate and climate-related issues in the three climate cases included in the definition of the reference evolution is described in the following. The initial state with regard to temperature and precipitation in Forsmark is defined in Section 4.4.1.

In characterising the uncertainty in the future evolution of climate and climate-related issues in Forsmark, time is given in relation to the present day (e.g. 1,000 years after present; 1 ka AP) in the SR-PSU climate cases. This reference frame is used in Figures 6-1, 6-2 and 6-3 which are reproduced from the **Climate report**. However, to facilitate comparison with the other subsections of this report, time is given in years AD in the text, where 0 ka AP corresponds to 2000 AD.

#### **Global warming climate case**

The evolution of climate-related conditions at Forsmark in the *global warming climate case* is displayed in Figure 6-1. This climate case describes a situation with moderate carbon emissions (CO<sub>2</sub> and CH<sub>4</sub>) in the current and next century, as defined by the Intergovernmental Panel on Climate Change (IPCC 2013), followed by a slow decrease in atmospheric CO<sub>2</sub> concentration such that glacial inception, i.e. growth of Northern Hemisphere ice sheets, starts around 52,000 AD. It was defined to represent the results of modelling studies of the next glacial inception described in Chapter 3 of the **Climate report**.



**Figure 6-1.** Evolution of climate-related conditions at Forsmark as a time series of climate domains and submerged periods for the global warming climate case. The corresponding evolution of permafrost and frozen depth, as well as relative shore-level, are shown in the lower panel. Time is given in relation to the present day, where 0 ka AP corresponds to 2000 AD. The figure is identical to Figure 4-3 in the **Climate report**.

For the period from 52,000 years to 102,000 years AD the global climate is assumed to cool gradually with intermittent ice sheet build up in the Northern Hemisphere. Similarly to previous glacial cycles, substantial climate variability produced by internal climate dynamics is expected, superimposed on the gradual cooling. This variability is not predictable, but a realistic pattern of variability has been defined based on the reconstructed Weichselian glacial cycle described in Chapter 3 of the **Climate report**. This period starts with periglacial climate conditions for 1,300 years, which is followed by a succession of temperate and periglacial climate periods ranging in length from a few centuries to almost 10,000 years.

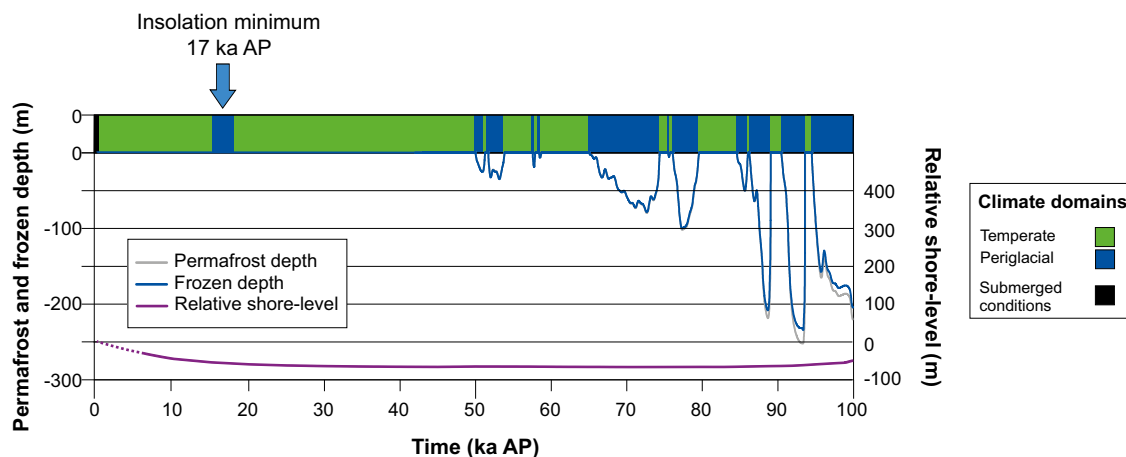
### Early periglacial climate case

The evolution of climate-related conditions at Forsmark in the *early periglacial climate case* is displayed in Figure 6-2.

Climate effects of carbon releases ( $\text{CO}_2$  och  $\text{CH}_4$ ) to the atmosphere are expected to persist for tens, if not hundreds, of thousands of years into the future (Archer et al. 2009). The *early periglacial climate case* represents the lower end of the uncertainty range associated with the amount of human and natural carbon emissions to the atmosphere, the global carbon cycle, and with the climate system response to the carbon emissions. It thus represents low human carbon emissions and a relatively fast decrease in atmospheric  $\text{CO}_2$  concentration.

The *early periglacial climate case* is defined as a variant of the *global warming climate case* with a faster decrease in atmospheric  $\text{CO}_2$  concentration resulting in climate conditions cold enough for permafrost development in Forsmark in the period of the minimum in summer solar radiation (insolation) at high northern latitudes around 17,500 to 20,500 AD. After this period, the Forsmark climate is assumed to return to the temperate climate domain. As in the global warming climate case, the atmospheric  $\text{CO}_2$  concentration is assumed to further decrease such that glacial inception, i.e. growth of Northern Hemisphere ice sheets, starts around 52,000 AD.

Beyond 52,000 AD, the *early periglacial climate case* is identical to the global warming climate case with a period of periglacial climate conditions starting at 52,000 AD, which is followed by a succession of temperate and periglacial climate periods of duration a few centuries to almost 10,000 years.



**Figure 6-2.** Evolution of climate-related conditions at Forsmark as a time series of climate domains and submerged periods for the early periglacial climate case. The corresponding evolution of permafrost and frozen depth, as well as relative shore-level, are shown in the lower panel. Note that the permafrost and frozen ground evolution is not shown for the period 0 to 50 ka AP. Permafrost and frozen ground can however not be excluded to a depth of about 150 m for the periglacial period from 15.5 to 18.5 ka AP (see Section 6.2.3). Time is given in relation to the present day, where 0 ka AP corresponds to 2000 AD. The figure is identical to Figure 4-5 in the **Climate report**.

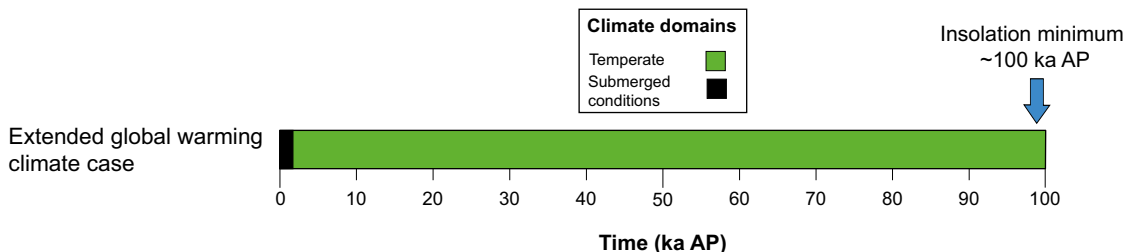


### Extended global warming climate case

The evolution of climate-related conditions at Forsmark in the extended global warming climate case is displayed in Figure 6-3. This climate case describes a situation with high carbon emissions in the current and next century, as defined by the Intergovernmental Panel on Climate Change (IPCC 2013), followed by a slow decrease in atmospheric CO<sub>2</sub> concentration such that glacial inception, i.e. growth of Northern Hemisphere ice sheets, starts around 102,000 AD. It was defined to represent the results of modelling studies of the next glacial inception described in Chapter 3 of the **Climate report**, which concluded that glacial inception is not expected until around 100,000 years after present if the atmospheric CO<sub>2</sub> concentration stays well above the pre-industrial value.

### 6.2.2 Shore-level evolution

One of the main processes of importance for repository safety in the temperate climate domain is changes in shore-level. The SFR repository is today covered by the Baltic Sea, with a maximum water depth of 7.2 m over SFR 1 and 5.3 m over the planned SFR 3 (layout L2). The location of the repository in relation to the shoreline will vary in time due to combinations of variations in the isostatic (vertical movements of the earth crust caused by glaciation and deglaciation) and eustatic (changes of mean ocean volume) sea level. At the end of the latest deglaciation around 8800 BC, the area was covered by approximately 150 m deep glacio-lacustrine water and the nearest shoreline was situated some 100 km west of Forsmark (see Söderbäck 2008, Chapter 3). Thereafter, the isostatic rebound has been continuous at a slowly declining rate, and it is predicted to decrease further to become insignificant around 30,000 AD. At present, the glacial isostatic rebound (GIA) amounts to circa 8 mm/yr (interpolated to the Forsmark site from Lidberg et al. (2010), see further in the **Climate report** Section 2.2.3). GIA is partly compensated by sea-level rise at present, resulting in circa 6 mm/yr land uplift today. As described in Section 3.3 of the **Climate report**, the projected future sea-level rise due to thermal expansion and glacier and ice-sheet melt is expected to be slow, extending over several millennia. The *global warming climate case* was defined based on GIA modelling of a future warm climate in which a complete melting of the Greenland ice sheet in the next 1,000 years was assumed. Due to gravitational effects, the global average sea-level increase of, in total, 7 m does not result in a sea-level rise in the Forsmark region (**Climate report**). The use of this shore-level evolution in the *global warming climate case* is therefore equivalent to assuming that the future eustatic contribution to shore-level change does not exceed the present eustatic contribution. This assumption is made in order to cover the full uncertainty associated with future sea-level changes. The *global warming climate case* represents the lower end of the uncertainty range, whereas the extended global warming case represents the upper end of the uncertainty range with a total eustatic contribution of circa 10 m in the next millennium (**Climate report** Sections 4.1.3 and 4.3.3). The eustatic contribution exceeds the isostatic contribution during this initial period resulting in about 1,200 years longer initial submerged period as compared with the *global warming climate case*. The two cases thus represent a minimum length period of submerged conditions above SFR in the *global warming climate case* as opposed to a maximum period of submerged conditions above SFR in the *extended global warming climate case*. The relative shore-level evolution in the *early periglacial climate case* is identical to that of the *global warming climate case*.



**Figure 6-3.** Evolution of climate-related conditions at Forsmark as a time series of climate domain and submerged periods for the extended global warming climate case. Time is given in relation to the present day, where 0 ka AP corresponds to 2000 AD. The figure is identical to Figure 4-7 in the **Climate report**.

In the *global warming* and *early periglacial climate cases*, the time required for 100% of the surface above SFR 1 and SFR 3 to have become land is circa 1,200 years (see the **Climate report** Section 2.2.4). Most of the surface above the repository has become land already after 1,000 years. Therefore, it is assumed that it takes circa 1,000 years for 100% of the surface above SFR 1 and SFR 3 to become land in the global warming and early periglacial variants of the reference evolution. For the *extended global warming climate case*, the time required for 100% of the surface above SFR 1 and SFR 3 to have become land includes an initial period of circa 1,200 years without shoreline regression followed by shoreline regression similar to that in the global warming and early periglacial variants of the reference evolution. Consequently, it is assumed that it takes circa 2,200 years for 100% of the surface above SFR 1 and SFR 3 to become land in the extended global warming variant of the reference evolution.

### 6.2.3 Potential for permafrost in Forsmark

The maximum isotherm depth during periods of periglacial climate domain in the *early periglacial* and *global warming climate cases* was determined based on a study on the potential for cold climate conditions and permafrost in Forsmark in the next 60,000 years (Brandefelt et al. 2013). At the time of the first occurrence of periglacial climate conditions in the *early periglacial climate case*, around 17,500 AD, the maximum depth of the 0°C isotherm is about 150 m (i.e. below SFR 3). It is however unlikely that bedrock temperatures of -3°C or less, relevant for analysis of freezing of concrete repository structures, would occur at SFR depth during this period (see the **Climate report** Section 4.2.4).

At the time of the first occurrence of periglacial climate conditions in the *global warming climate case*, around 52,000 AD, bedrock temperatures of -3°C or less cannot be excluded (see the **Climate report** Section 4.2.4).

## 6.3 The first 1,000 years after closure

After closure, the engineered structures will slowly become hydraulically saturated. In the perspective of the long duration of the safety assessment period, the saturation process is assumed to be instantaneous upon closure and submerged conditions can be assumed. The climate is expected to remain temperate during the first 1,000 after closure and the engineered barriers are expected to retain their properties.

As described in Section 6.2.3, land uplift due to a combination of isostasy and eustasy results in shoreline regression at Forsmark. Several processes and events are highly affected by the shoreline regression. In the global warming and early periglacial variants of the reference evolution, the surface above the repository will gradually rise above sea level during the first 1,000 years after closure and at the end of the period the entire area above the repository will be situated above the shoreline. In the extended global warming variant of the reference evolution, an initial period of circa 1,200 years without shoreline regression is assumed. Thereafter the surface above the repository will gradually rise above sea level and after another 1,000 years (circa 2,200 years after closure) the entire area above the repository will be situated above the shoreline.

The early evolution of the repository is based on quantitative analyses and is described in detail as required in the regulation SSMFS 2008:37.

### 6.3.1 Evolution of surface systems

Long-term landscape development in the Forsmark area is dependent on two main and partly interdependent factors: climate variations and shoreline evolution (see Section 6.2). These two factors in combination strongly affect a number of processes, which in turn determine the development of ecosystems and future conditions of importance for radionuclide transport, exposure and resulting doses and risk. Examples of such processes are erosion and sedimentation, groundwater recharge and discharge, soil formation, primary production, and decomposition of organic matter. These processes are discussed in relation to landscape development in more detail in the **Biosphere synthesis report**. According to results from the hydrogeological modelling (Odén et al. 2014), discharge of deep groundwater will almost exclusively take place at low points in the landscape, i.e. in lakes, wetlands, and streams, and in near-shore areas of the sea. Thus, the present description of landscape development is focused on these areas, as this is where accumulation of potentially released radionuclides may occur.

The present regressive shoreline evolution will continuously bring new areas of the sea floor above the wave base. This will expose sediments to wave erosion and resuspended fine-grained particles will be transported out of the area into the Bothnian Sea, or re-settle on the sea bottom within the parts of the study area with the largest water depths (Brydsten and Strömberg 2010, **Biosphere synthesis report**). Accordingly, the relocation of sediments may have important implications for transport and accumulation of radionuclides potentially originating from the repository.

When new areas of the present seafloor are raised above sea level, weathering of the lime-rich regolith is initiated. However, although the strong influence of the lime-rich deposits on the terrestrial and limnic ecosystems will be diminished over time, the ecosystems will be influenced by calcium for the first 1,000 years e.g. resulting in oligotrophic hardwater lakes (see Andersson 2010).

The shoreline evolution will also cause a continuing and predictable change in the abiotic environment, e.g. in water depth and nutrient availability. It is therefore appropriate to describe the origin and succession of major ecosystem types in relation to shoreline evolution. One example of this is the isolation of a sea bay into a lake, followed by the ontogeny of the lake and its development into a wetland. As the lake ages, sediment and organic matter accumulate due to sedimentation and vegetation growth, and eventually all lakes are transformed to wetlands. The rate of sedimentation in the lakes is dependent on lake volume (Brydsten 2004), whereas the colonisation of littoral plants requires shallow water (< 2 metres). Thus, the rate of lake infilling is mainly dependent on lake depth, area and volume (Brydsten and Strömberg 2010, **Biosphere synthesis report**). Mires may also develop on newly emerged land without a preceding lake stage (Kellner 2003).

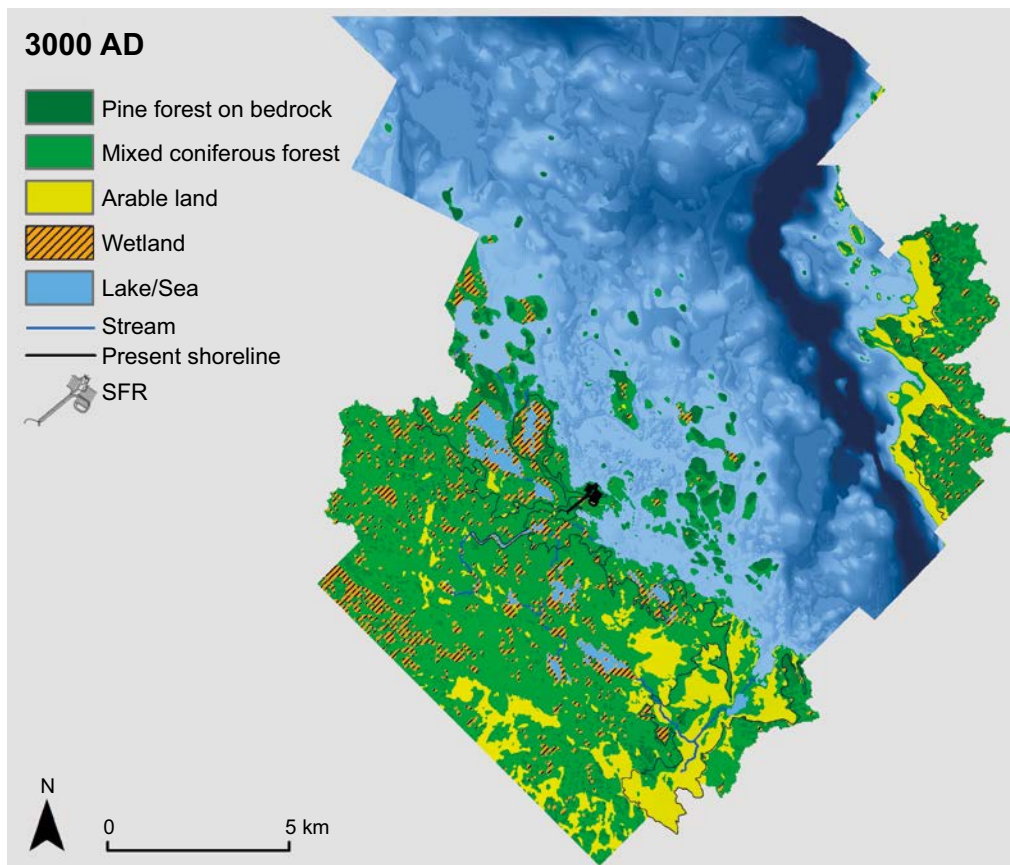
For the modelled area at Forsmark it also takes time for a change in environmental conditions to propagate from one end to the other. For instance, the landscape development modelling shows that it has taken some 3,000 years for shoreline evolution to transfer the area from fully submerged just before the first islet emerged from the sea (1000 BC) to the present distribution of land and sea areas, and that it will take some 9,000 years more until the last marine embayment is turned into a lake (around 11,000 AD). Based on an almost constant shore-level change rate of 6 mm/yr, the vertical component of the shoreline evolution is projected to be about 6 m during the next 1,000 years. The resulting shoreline displacement implies a horizontal transfer of the coastline to a location above the SFR repository at 3000 AD (Figure 6-4). In this process, parts of the present seafloor will become land and some of the coastal bays will be isolated and transformed to lakes. The ongoing shoreline regression causes a succession pattern, in which shore vegetation will be replaced by forest vegetation. The types of dominating vegetation communities during this succession are mainly determined by the composition of the underlying regolith.

The newly isolated lakes will occasionally be affected by flooding with brackish water from the Bothnian Sea during periods of high sea water levels, in the same way that can be seen in low-elevation present-day lakes in the area (Johansson 2008). All the present lakes in the Forsmark area are small and shallow. This means that large parts of the lakes will be transformed to wetlands during the coming 1,000 years (Brydsten and Strömberg 2010, **Biosphere synthesis report**). For example, two of the smaller lakes, Lake Puttan and Lake Norra Bassängen, are expected to be almost completely transformed to wetlands, whereas a minor part of the larger Lake Bolundsfjärden will remain as open water in the year 3000 AD (see Appendix H for a map of the Forsmark area today).

The human-made, deep inlet canal for cooling water to the nuclear power plants, situated south of the repository, will become isolated from the sea around 2500 AD (Lindborg 2010). If it is left unaltered after decommissioning of the power plants, it will probably remain as a lake far beyond the initial 1,000 years. Relatively large lakes situated west and north-west of the SFR repository will become isolated from the sea in the latter part of the period (see Figure 6-4).

As the sea close to the coast gets shallower, erosion will occur on wave-exposed bottoms. Some sheltered areas inside a developing, denser archipelago will show accumulation for a short period (Brydsten 2009). The circulation in Öregrundsgrepen is expected to remain essentially the same as today (Karlsson et al. 2010). The salinity of the Bothnian Sea is expected to decrease slightly to around 4.8‰ during the initial 1,000 years (Gustafsson 2004).

The potential for sustainable human exploitation of food resources in the area over the coming 1,000 years is not expected to differ much from the situation today. Only minor parts of the newly formed land will have the potential for cultivation due to the boulder-rich sediments in the former sea and lake areas, but also due to problems with draining the low-elevation new areas (Lindborg 2010).



**Figure 6-4.** Modelled distribution of vegetation and land-use in Forsmark at 3000 AD for the global warming climate case. All areas that potentially can be cultivated are represented on the map as arable land; see the *Biosphere synthesis report* for details on the landscape development modelling. The present shoreline is marked as a black line and darker shades of blue represent deeper sea.

The potential water supply for humans is expected to be roughly unaltered during this period. In the future, the deep canal south of the repository has potential as a freshwater reservoir when the salinity decreases, and also the stream through Bolundsfjärden may potentially be used for freshwater supply. New wells may be drilled in the bedrock or dug in the regolith in the area which is land today, whereas the new land will be too young for wells if current practices are maintained (Kautsky 2001). Future water supply and potential well locations in the area are discussed in Werner et al. (2014). For agricultural areas, it is assumed that wells are found in areas 1 m or more above sea level (m.a.s.l., Werner et al. 2013). The area above the repository will not be suitable for agricultural purposes due to the geological composition of the regolith (Sohlenius et al. 2013b), and for such areas, data from the national well database (SGU 2011) indicates that wells are not drilled so close to the shoreline.

The description above, which involves land uplift and a succession resulting in new land areas outside the present shoreline during the first 1,000 years, is considered applicable in both the *global warming* and *early periglacial climate cases* (**Climate report**). In the extended global warming climate case, there might instead be an initial period of rising sea level and sea transgression. However, uncertainties in the degree of sea-level rise are large. The isostatic rebound eventually counteracts this initial sea level rise and by the end of the period, i.e. at 3000 AD, the shoreline position in the extended global warming climate case is expected to be approximately the same as at the present.

### 6.3.2 Thermal evolution

The temperature of the repository will be determined almost entirely by the exchange of heat with the surrounding rock and groundwater. Heat transport can essentially be expected to take place via heat conduction and is governed by the thermal conductivity and heat capacity of the materials.

The impact of the repository on the temperature is negligible, since there are no significant heat generating processes in SFR.

During the first thousand years after closure, no change in climate is expected that would lead to freezing of the repository.

### 6.3.3 Mechanical evolution

Mechanical processes are the consequence of changing boundary conditions, such as the doming of the ground surface associated with glaciation cycles or the rapid stress redistribution that can occur during blasting of an excavation. The most significant changes of the mechanical conditions of the SFR rock mass take place during excavation of the rock caverns (see the **Geosphere process report** Section 4.1) and these are not further discussed in the reference evolution.

Mechanical processes/deformation of the rock might influence the hydraulic conductivity indirectly through changes in fracture and pore geometry. The rock stresses needed for this to occur are mainly related to glaciation (large rock loads) where increased pore pressures and propagation of fractures may change the hydraulic conductivity through changes in the fracture network. During the assessment period this is not likely to happen and is of negligible significance compared with the overall uncertainties associated with the fracture network modelling (**Geosphere process report** Section 4.2 and Chapter 3).

The SFR installations and structures, such as rock reinforcement, concrete waste compartments, bentonite, backfill and plugs, will be in direct or indirect mechanical contact with the rock walls. Loads from the structures, for example from the concrete plugs due to swelling pressures from bentonite backfill, will cause mechanical processes in the intact rock and the existing fractures close to these locations. During the initial period of temperate climate domain in the reference evolution, there will be an on-going degradation of the reinforcements. This degradation will to some extent alter the stress distribution locally around the reinforced rock caverns.

A numerical study of long-term stability of the BMA and BLA vaults has been carried out by Mas Ivars et al. (2014). This study had two objectives: to analyse if there is a risk for loosening of the rock up to the surface and if there is a risk of instability in the pillars between vaults. In the rigid block model cases where the blocks were allowed to fall into the vault, the caving process stopped after the empty space was filled with blocks. The height of the loosened rock mass reached at this stage up to 34 m above the roof, and above this level a stable arch is formed, and the caving does not in any analysed case continue up to the sea floor. This means that there should be no risk that a direct connection between the vaults and the seafloor will develop. The numerical analyses also predict that the pillar between the BMA and BLA vaults of the model is stable.

A piece of the rock wall may after a long time come loose and fall out on the filling of the bentonite in the silo. This could potentially lead to the formation of an open void in the rock wall, under the circumstances that the bentonite is unable to keep the rock piece in position (due to loss in swelling pressure). And vice-versa, the rock fallout may lead to a loss in bentonite compression, thereby making the diffusion barrier thinner. The consequences of such an event have been investigated with both analytical and numerical modelling (Börgesson et al. 2014). Results from finite element calculations of rock block fall outs where the bentonite does not fulfil the swelling pressure requirements (Börgesson et al. 2014), shows that there might be a substantial displacement. However, they also show that the consequence is a consolidation of the bentonite and subsequent increase in the swelling pressure that ends in a stable situation with a remaining substantial thickness of the bentonite barrier.

Earthquakes can affect the stability of the rock as well as the stability of the repository. The seismic activity in the Fennoscandian shield is currently very low. However, large intraplate earthquakes cannot be ruled out in a 100,000 year perspective, as evidenced by the events in New Madrid (USA), Ungava (Canada), West Australia and elsewhere (e.g. Gangopadhyay and Talwani 2003). Since it is not possible to predict when future earthquakes will occur and what magnitude they will have, earthquakes are treated in a distinct scenario. Background, statistics and impact of earthquakes are dealt with in the description of this scenario in Section 7.6.5.

### 6.3.4 Hydrogeological evolution

In fractured crystalline rock, groundwater flow occurs predominantly in connected fractures. When radionuclides are potentially released from the repository, groundwater flow and retention processes in the rock control the rate at which the radionuclides are transported away from the repository and where they discharge. Due to the importance of the groundwater flow for the transport of radionuclides, low flow in bedrock is one of the safety functions defined in Chapter 5. Based on the site characterisation, a hydrogeological model for the site has been developed (SKB 2013e). This model has been used to assess the groundwater flow through the repository and how particles released from the repository will be transported through the far-field (through particle tracking). The positions of discharge areas, i.e. the exit locations of particles identified by means of particle tracking, change with time and are mainly determined by the combined effects of the glacial isostatic rebound and sea-level change, leading to changes in the shoreline and to the creation and/or loss of lakes and rivers.

The hydrogeological model encompasses a regional area for which outer boundaries have been selected on the basis of natural hydraulic boundary conditions (future groundwater divides) and taking shoreline evolution into account. The results from the hydrogeological model are used as boundary conditions in the near-field model. The near-field model (further discussed in Section 6.3.5) includes a detailed description of the repository and the surrounding rock mass and fracture zones. This model also includes the various structures inside the waste vaults.

The long-term evolution of the hydrogeological system is dependent on two main factors: climate variations and shoreline evolution (see Section 6.2). Shoreline evolution will change the boundary conditions for groundwater flow as the area above the repository starts in a submerged position and evolves towards a terrestrial position.

#### ***Submerged conditions***

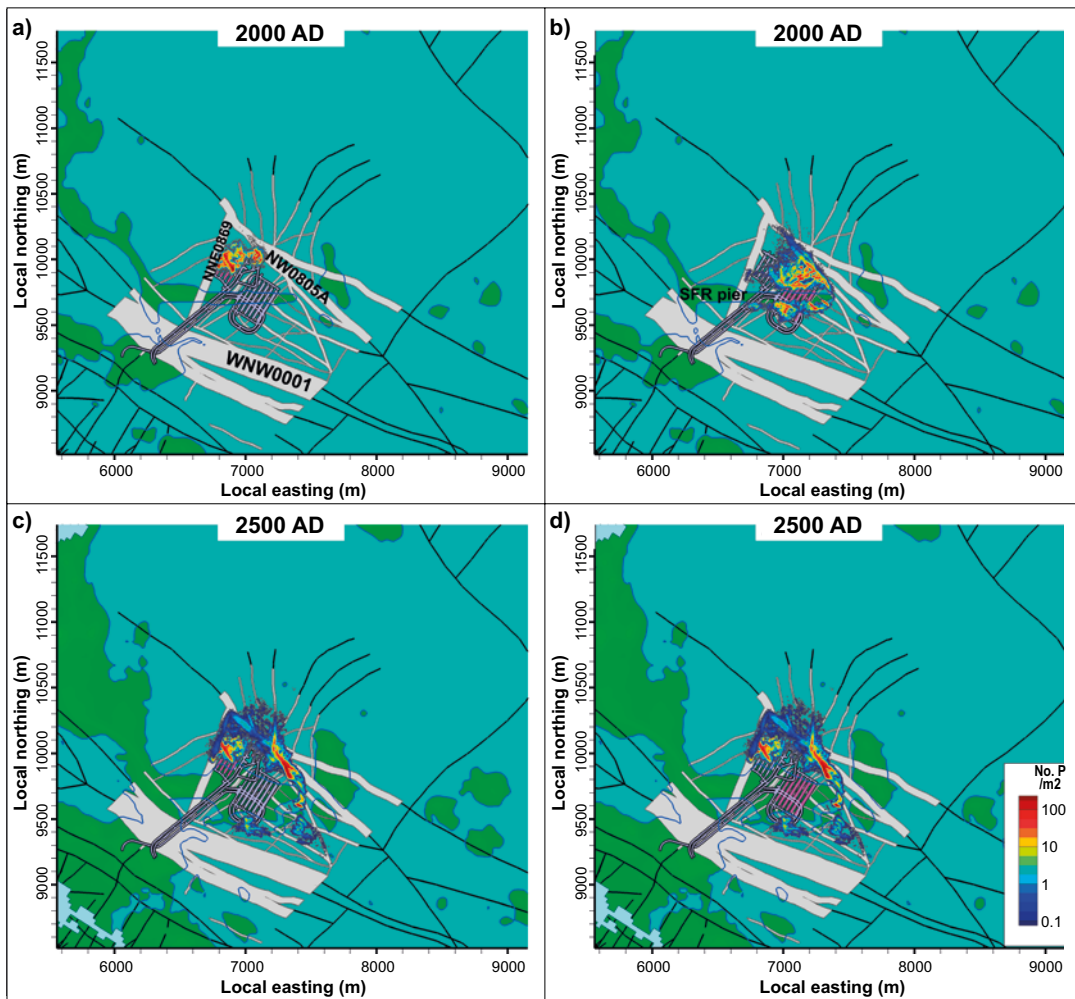
During the first 1,000 years after closure, the main factor of importance for groundwater flow is shoreline evolution. When an area is transformed from being covered by the sea, or a lake, to dry land, groundwater flow will change as the hydraulic gradient increases, and areas previously associated with discharge can be transformed to recharge areas. The present situation in Sweden with annual precipitation exceeding annual evaporation is assumed to be valid for this period, such that the formation of deep groundwater is always great enough for the water table to roughly follow the topography (**Geosphere process report** Chapter 3).

The discharge areas for the groundwater that has passed through the waste vaults will be at the sea floor during this period (Odén et al. 2014). Hydrogeological modelling shows that shoreline displacement gradually forces the discharge areas further away from the repository towards the deformation zones in north-north east (ZFMNNE0869) and north-west (ZFMNW0805A) of the repository, see Figure 6-5. (The zones are denoted without the prefix ZFM in the figures).

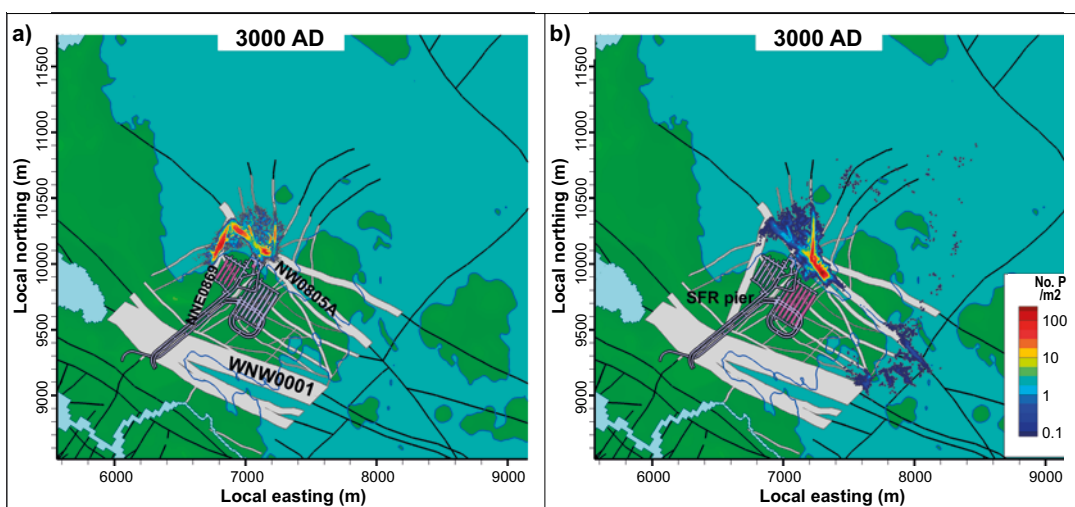
The flow regime changes, due to the shoreline displacement, from being mainly directed upwards during the beginning of the period to being more horizontal at the end (Odén et al. 2014). The density (particles/surface unit) of exit locations is strongly correlated to deformation zones. The dominant flow path from SFR 1 discharges in ZFMNNW1209 (deformation zone, called Zone 6 in SAR-08, cutting through the rock vaults in SFR 1) during the time slices 2000 and 2500 AD. In the early stages, SFR 3 has exit locations both north and south of the SFR pier. As the horizontal component in the flow regime successively grows, the exit locations are driven north, towards ZFMNW0805A, see Figure 6-5.

#### ***Shore conditions***

About 1,000 years after closure, shore conditions will dominate the area above the repository, see Figure 6-6. The flow regime is now almost parallel to the topographic gradient (Odén et al. 2014). The particles still exit at the sea floor and the density of exit locations is strongly correlated to deformation zones. The dominant discharge area of flow paths from SFR 1 is north-north east and north-west of the repository (ZFMNNE0869 and ZFMNW0805A). SFR 3 has exit locations both north and south of the SFR pier, but the exit locations are now more concentrated to ZFMNW0805A, see Figure 6-6.



**Figure 6-5.** Exit locations (coloured by particle density, bottom right) for particles starting in the SFR 1 waste vaults (pink shade; left) and in the SFR 3 waste vaults (pink shade; right), time slices 2000 and 2500 AD. The black lines represent deformation zones. The white areas also represent deformation zones, but zones closer to the SFR repository where the width of a white area indicates the zone thickness at ground surface.



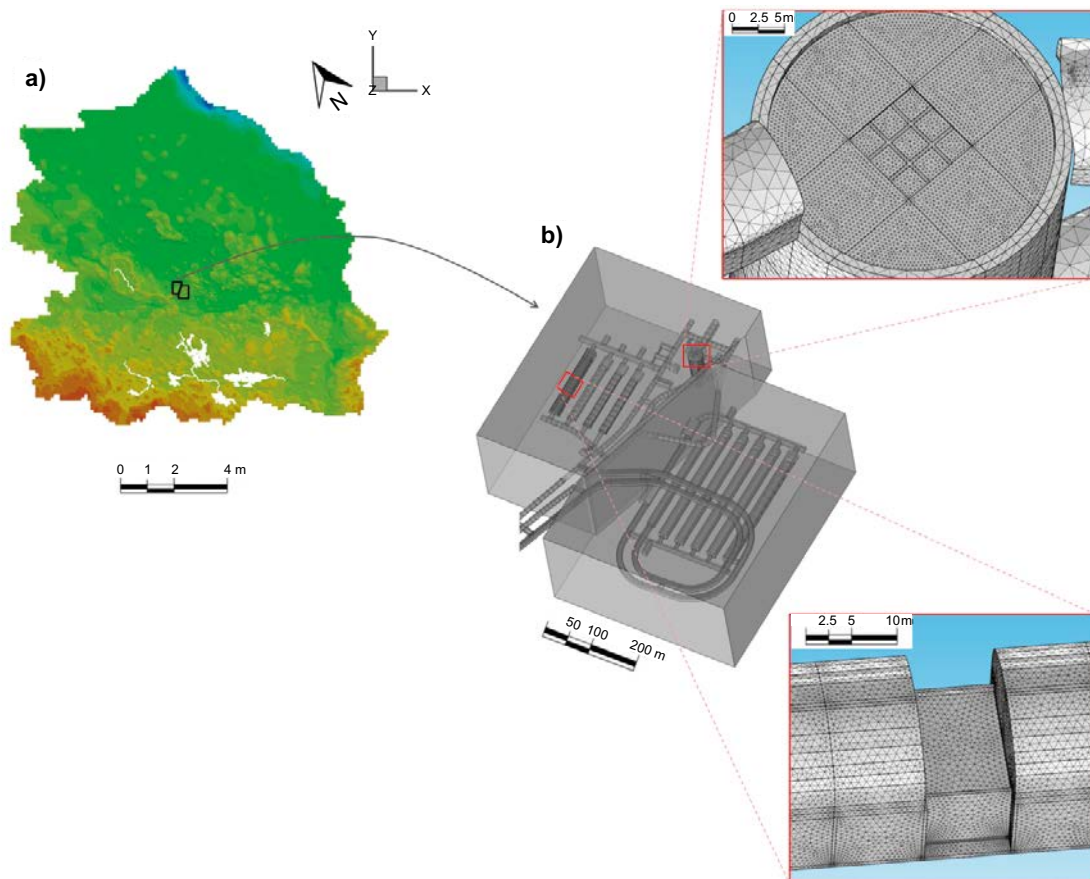
**Figure 6-6.** Exit locations (coloured by particle density, bottom right) for particles starting in the SFR 1 waste vaults (pink shade; left) and in the SFR 3 waste vaults (pink shade; right), time slice 3000 AD. The black lines represent deformation zones. The white areas also represent deformation zones, but zones closer to the SFR repository where the width of a white area indicates the zone thickness at ground surface.

### 6.3.5 Near-field hydrological evolution

SFR is located in an area with a limited hydraulic gradient and limited fracture transmissivity. The site for the repository was in part selected for its ability to ensure low water flows through the waste vaults. The waste vaults have been designed with different capabilities for limiting the water flow. Concrete and bentonite are the main construction materials used for the flow barriers in the SFR. The silo, which will hold the majority of the activity in SFR, has a combination of bentonite and concrete barriers. The intermediate-level waste in 1BMA and 2BMA is emplaced in concrete compartments, where the walls, floor and lids of the structures limit the flow through the waste. In these vaults, a highly permeable backfill of crushed rock will be installed at closure, creating a hydraulic contrast between the concrete structure and the backfill, and between the backfill and the rock. Water entering the vaults will then preferentially flow through the backfill, which reduces the flow through the concrete barriers. In 1BTF and 2BTF, the grouted concrete tanks constitute a flow barrier. A high permeability backfill will be installed on top of the concrete structures. The BRT vault will hold reactor pressure vessels. The pressure vessels will be filled with concrete or cementitious grout and embedded in grout. Crushed rock will be used to backfill the vault creating a preferential pathway for groundwater flow. The BLA vaults, containing low-level waste in ISO-containers, have no internal structures restricting the water flow. However, the rock surrounding the repository will limit the flow substantially. In addition to flow barriers installed in the waste vaults, tunnel sections connecting them will be sealed with bentonite to further restrict water flow (see Section 4.2.8).

Results from regional hydrogeology simulations have shown that the presence of SFR 3 has only a modest effect on the groundwater flow in SFR 1 (Öhman et al. 2014). The hydrological near-field models of SFR 1 and SFR 3 include the waste vaults and the tunnel system that connects them (see Figure 6-7). The models and results from simulations are presented in detail in the modelling reports (Abarca et al. 2013, 2014).

The initial state of the waste vaults and tunnel system is further described in Chapter 4.



**Figure 6-7.** The regional hydrogeology model (a) provides boundary conditions to the near-field models (b) of SFR 1 and SFR 3. The near-field models describe in detail the structures in the different vaults.



The evolution of the regional hydrogeology, which constitutes the boundary conditions for the near-field hydrogeological evolution, is described in Section 6.3.4.

Figure 6-8 summarises the total flows ( $\text{m}^3/\text{yr}$ ) through the vaults as calculated by the SFR 1 and SFR 3 near-field models, illustrating the increasing pressure gradient as the shoreline retreats. Results show that during the first thousand years after closure the vault flows increase by approximately two orders of magnitude going from submerged conditions (Shoreline position 1) to shore conditions (Shoreline position 2). This is the most important process affecting the flow through the repository during this time period.

### **Impact of concrete degradation**

During the first thousand years after closure, degradation processes start to influence the hydraulic properties of concrete structures and materials in the repository (see Section 6.3.8). The resulting effect on groundwater flow through the repository is however small compared with the increase in flow due to the retreating shoreline (Abarca et al. 2013). Section 6.4.5 outlines the effect of more progressed concrete degradation on the flow in the repository near-field.

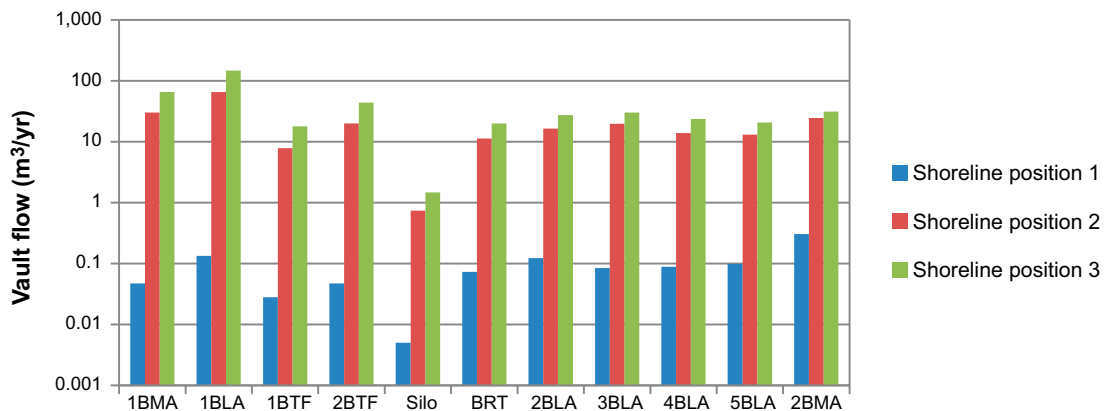
### **Impact of bentonite degradation**

The hydraulic properties of the bentonite barriers in the repository are not expected to change during the first thousand years after closure. Section 6.4.5 outlines the effect bentonite degradation on the flow in the repository near-field at later times.

## **6.3.6 Geochemical evolution**

The geochemical evolution is closely related both to climate changes and shoreline evolution (see Section 6.2) and the hydrogeological evolution (see Section 6.3.5), where water interactions with the rock, and groundwater flows are of major importance. The isostatic rebound will result in changing flow paths and flow conditions (see Section 6.3.4), which in turn may affect geochemical processes through changes in water velocities, contact times and surface areas of the fractured rock.

A number of processes in the geosphere will affect the geochemical evolution and, hence, the future conditions of importance for radionuclide transport, which in turn will affect the resulting doses and risks. Examples of such processes are thermal gradients in the rock, erosion and sedimentation (in fractures), groundwater recharge and discharge (groundwater flow), chemical processes related to transport and concentrations of dissolved solids (advection, diffusion, sorption, dissolution and precipitation of fracture minerals, dissolved organic matter, colloid transport and microbial activity) and radionuclide transport in the rock. These processes are discussed in relation to different climatic events and their importance for the safety assessment in the **Geosphere process report**.



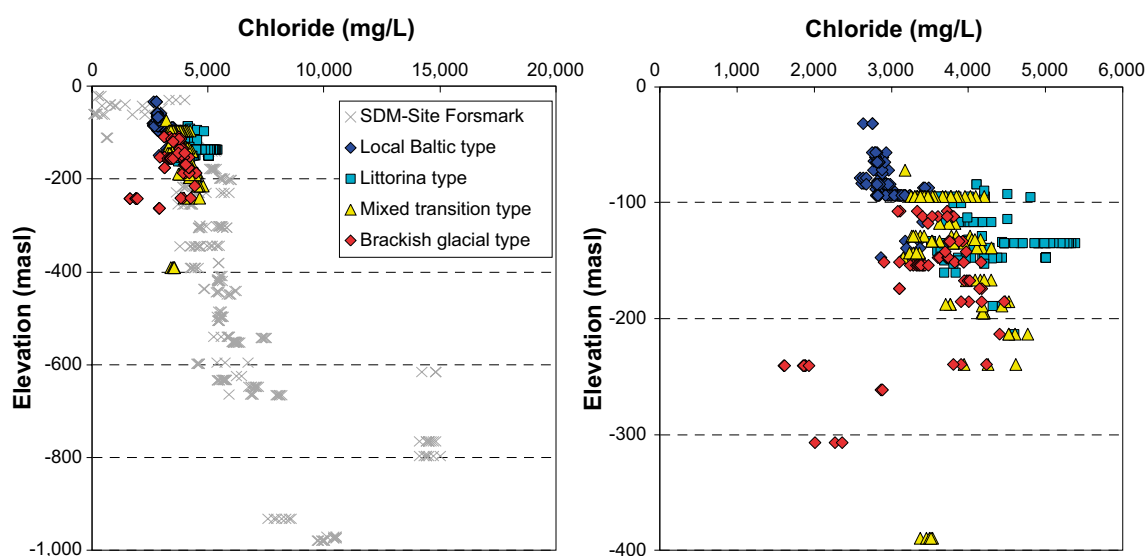
**Figure 6-8.** Flow ( $\text{m}^3/\text{yr}$ ) in the vaults of SFR 1 and SFR 3 as a function of repository position relative to the shoreline.

Previous evolution of the rock geochemistry will condition the present and future state of the groundwater composition. During Weichselian and Holocene times, the present area of the Baltic Sea has evolved (Westman et al. 1999, SKB 2008a). Before the intrusion of meltwater from the last deglaciation, brackish groundwater without marine signature, but with components of old meteoric waters from both temperate and cold climate events, was present. This water was then mixed with glacial meltwater during the Weichselian glaciation due to the high hydrostatic pressure in the rock. Under such conditions, it is possible that a larger number of fractures become conductive or that the conductivity in existing fractures/fracture zones increases. This may be an explanation of the down-ward transport of dilute melt water from previous glaciations, which still can be traced in the area.

During the subsequent Littorina Sea stage, brackish seawater with higher density entered some of the deformation zones and fractures previously infiltrated by meltwater, and mixed with or displaced the resident fresh groundwater. Other fracture systems were probably closed at the time due to a changed pressure situation, which therefore trapped brackish non-marine groundwater with a significant glacial component that still resided in this less fractured bedrock. The groundwaters in SFR represent a relatively limited salinity range (1,500 to 5,500 mg chloride per L), see Figure 6-9. However, the  $\delta^{18}\text{O}$  values, as an indicator for colder climate conditions, show larger variation ( $-15.5$  to  $-7.5$ ‰ V-SMOW (Vienna Standard Mean Ocean Water)), similar to that reported from the site investigations for the spent fuel repository (Laaksoharju et al. 2008, denoted SDM-Site Forsmark). Low  $\delta^{18}\text{O}$ -levels,  $<-13$  permille V-SMOW, is interpreted for the Forsmark area as if there is a significant proportion of glacial melt water in the waters. Marine indicators also show relatively large variations at SFR, considering the limited salinity range. Hydrogeochemical observations together with paleoclimatic considerations has been used to classify the groundwaters into four major types, each of which have very different residence times in the bedrock. The groundwater types are: 1) local Baltic Sea water type, 2) Littorina type water, with a glacial component, 3) brackish glacial water type, and 4) mixed brackish water (transition type).

The distribution of the different groundwater types shows that the major deformation zones must have served as important groundwater flow pathways over long time periods, whereas single fractures in rock volumes between zones generally contain older and more isolated groundwater. Due to the hydraulic situation around the present SFR, the mixed brackish groundwater type has become more and more frequent since the excavation and construction of the SFR (Nilsson et al. 2011). The steeply dipping structures have accentuated the drawdown of modern Baltic Sea water that has been observed.

Following the initial period (Chapter 4) when the vaults, structures, backfill, and waste packages have become saturated with groundwater, the extent and direction of advective transport of substances is governed by their dissolved concentrations and the local groundwater flow field.



**Figure 6-9.** Distribution of chloride with depth in the SFR area and SDM-site Forsmark area (left) and SFR only (right) (from Nilsson et al. 2011). The samples are colour-coded according to the different groundwater types defined for the SFR site description by Nilsson et al. (2011).

The chosen reference composition of penetrating brackish groundwater and ranges of the parameters of interest for the first 1,000 years (of the initial temperate climate domain), when the repository is submerged beneath the Baltic Sea, are presented in Table 6-1. The reference composition is based mainly on the dataset compiled for the SFR extension Site Descriptive Model (Gimeno et al. 2011, Nilsson et al. 2011, Auqué et al. 2013), where site data for groundwaters down to a depth of –200 m are used.

A slower apparent dilution of the present brackish groundwater may be the result due to mixing with, or diffusion of more saline groundwater-remnants in the rock occurring over time. The most dilute brackish groundwater of the local Baltic type, is found at shallow depth down to 100 metres (Nilsson et al. 2011). When the ground surface above SFR is situated above sea level, human activities such as drilling may influence the groundwater composition by short-circuiting groundwaters with different hydrochemistry. However, those activities are not expected to occur within the time frame of thousand years after closure (see Section 6.3.6). Such induced changes in groundwater composition would then primarily affect the fracture-filling minerals and would not affect the rock matrix minerals to any significant extent.

Adjacent to or downstream the repository, high pH conditions originating from the degradation of the engineered barriers (Section 6.3.8), the fracture geometry is assumed to be unaffected by chemical processes such as dissolution and precipitation (of fracture minerals) and hence will not significantly alter flow paths, indirectly hydraulic conductivity (**Geosphere process report** Section 5.6).

However the induced changes in pH, ionic strength and eventually changed redox conditions of the groundwater affected by near-field water composition (see Section 6.3.7, Water composition), may affect the colloidal stability. Since the radionuclide concentrations are considered to be insignificant, the effect of colloidal transport is not of any concern for the repository safety (**Geosphere process report** Section 5.9.7).

### 6.3.7 Chemical evolution of the waste

This section discusses the events and processes of importance for the evolution of the waste. In section 6.3.7, 6.4.7 and 6.5.7 the waste is defined as material, radionuclides, waste solidification or embedment material, waste matrix (waste form), waste containers and grout used around the waste containers. It is difficult to describe the waste without mentioning and to some extent describe the concrete barriers because processes that take place in the waste are also affected by the latter and vice versa. Therefore the chemical evolution of the concrete barriers is also discussed to some extent in this section. This section describes the reference evolution of the waste, the waste form and waste containers, water composition, speciation of radionuclides, metals corrosion, organic complexing agents, microbiology, gas generation and gas transport.

**Table 6-1. Expected composition of penetrating brackish groundwater during the first 1,000 years of the temperate climate domain (based on Gimeno et al. (2011), Nilsson et al. (2011), Auqué et al. (2013)).**

	Composition	Range
pH	7.3	6.6–8.0
Eh (mV)	–225	–100 to –350
Cl <sup>–</sup> (mg/L)	3,500	2,590–5,380
SO <sub>4</sub> <sup>2–</sup> (mg/L)	350	74–557.2
HCO <sub>3</sub> <sup>–</sup> (mg/L)	90	40–157
Na <sup>+</sup> (mg/L)	1,500	850–1,920
K <sup>+</sup> (mg/L)	20	3.8–60
Ca <sup>2+</sup> (mg/L)	600	87–1,220
Mg <sup>2+</sup> (mg/L)	150	79–290
SiO <sub>2</sub> (mg/L)	11	2.6–17.2

The durability of the near-field system is highly dependent of the longevity of the engineered barriers in the repository as they are affected by chemical reactions that take place when the barriers come into contact with the groundwater and waste. The chemical evolution of the barriers is also of importance for sorption and for the release of radionuclides and other species. Gas formation can give rise to fracturing of the barriers and faster transport of radionuclides. Leaching and formation of different phases can cause porosity changes and fracturing, which in turn affects radionuclide transport via advection and diffusion through the barriers. Further, change in the composition of the barriers will also affect sorption capacity. Different radionuclides are affected in different ways by the chemical environment. The groundwater reaching the repository during this period is expected to be brackish to saline (in the rock domain) and its composition is given in Section 6.3.6. High pH and high calcium concentrations in the concrete porewater reduce the concentration of some complexing agents, such as oxalate and ISA due to precipitation of Ca-salts. Several of the radionuclides are redox-sensitive, with varying retention behaviour depending on the redox state. High ionic strength weakens sorption for certain radionuclides. Complexation, with organic ligands that form soluble complexes with the radionuclides, can reduce sorption as well.

### ***Waste form and packaging***

The waste in SFR is packed in packaging of steel or concrete, and in many cases the waste inside the packaging is solidified in cement or bitumen or embedded in concrete.

#### **Steel packaging**

Due to corrosion, steel packaging is not regarded as a barrier to the transport of water, gas or radionuclides. The corrosion products that are formed during the operational phase – iron oxides and possibly iron hydroxides – can be good sorbents for radionuclides that are present in the water as cations. Metal ions with properties similar to iron could also be co-precipitated with the corrosion products. In the assessment, products from the corrosion of iron and steel have not been regarded as a sorption barrier, even though there is a strong body of experimental and conceptual evidence showing that iron oxides and iron hydroxides sorb and co-precipitate many elements. On the other hand, corrosion of iron and steel gives rise to reducing conditions in the repository, which is taken into account.

#### **Concrete packaging and cement matrices**

Calculations regarding the leaching of concrete show that concrete packaging and cement matrices will not be subjected to any significant leaching of cement components during the first 1,000 years (Höglund 2001, Gaucher et al. 2005, Cronstrand 2007, 2014). However it cannot be excluded that local mineral alterations at the surface of the packaging can take place, see Section 6.3.8.

Corrosion of rebar and the resultant volume increase could cause small fractures in the concrete nearest to the rebar. This is not expected to be of importance for the properties of the concrete packaging as a sorption barrier for radionuclides. But the possibility cannot be ruled out that some fracturing of cement matrices will occur as a result of corrosion of metals in the waste and the volume increase caused there by the corrosion products.

Other processes that could eventually (though hardly during the first 1,000 years) cause fracturing of concrete packaging and cement matrices are carbonatisation and ettringite formation in pores when sulphate from evaporator concentrate and degraded ion-exchange resins reacts with cement minerals. Complete degradation of ion-exchange resins could lead to such extensive ettringite formation that the concrete packaging will burst. However, the chemical conditions in SFR do not favour degradation of the ion-exchange resins. Furthermore, conditions in the waste packages are not particularly favourable for microbial activity.

#### **Waste matrices of bitumen**

Bitumen is a colloidal system consisting mainly of high molecular aliphatic and aromatic hydrocarbons that is used for solidifying low- and intermediate-level waste (Pettersson and Elert 2001). Ion-exchange resins, to some extent mixed with evaporated salts, are solidified in bitumen before

being placed in waste packaging. The bituminised waste is allocated to the silo, 1BMA and BLA. In the bituminisation process, waste is mixed with hot bitumen, resulting in a bitumen matrix with a dispersion of embedded waste particles. Although pure bitumen is a hydrophobic material, water can be transported into a bitumen matrix containing resins or salts. Also, in a waste package where bitumen is mixed with ion-exchange resins and evaporator concentrate, the properties of the bitumen matrix can change with time. Processes that can lead to such changes are radiolysis, chemical degradation, biodegradation, water uptake, swelling and ageing.

Depending on the properties of the waste, the driving force for water uptake can be described as a gradient in chemical potential (Sercombe et al. 2006), water activity or water concentration (Brodersen 1999). However, the different descriptions give similar results. The bituminised waste deposited in SFR consists mainly of ion-exchange resins and relatively small amounts of evaporated salts (Pettersson and Elert 2001). In the case of evaporated salts, the chemical composition of the waste, mainly its solubility, is important. Salts with relatively high solubility such as  $\text{NaNO}_3$  and  $\text{Na}_2\text{SO}_4$  can create low chemical potentials, whereas more insoluble salts such as  $\text{BaSO}_4$  or sludges are relatively inert. As far as ion-exchange resins are concerned, the situation is more complex and depends on the type of resin used (cation- or anion-exchanger, powdered or bead, degree of cross-linking), the extent of drying of the resin, and pre-treatment of the resin by for example heat (Pettersson and Elert 2001).

When ion-exchange resins and evaporated concentrates absorb water, they expand in volume. The theoretical degree of expansion of the waste depends on the type of waste. The degree of swelling will depend on the mechanical properties of the bitumen, the waste loading and the homogeneity of the waste form.

Different strategies are applied to prevent adverse effects of swelling bitumen waste forms on the concrete flow barriers.

- In 1BMA, grouting must be done in such a way that there is enough free volume available to accommodate the increased volume.
- In 2BMA, no bituminised waste form will be deposited.
- In the silo, engineered expansion cassettes are placed between the drums of bituminised waste from the Barsebäck nuclear power plant. Bituminised waste from the Forsmark nuclear power plant has between 5 and 10% free void inside the moulds to accommodate the swelling. However, there is probably not enough free volume to accommodate all volume expansion. According to von Schenck and Bultmark (2014), the internal structure of the silo will probably be affected in the future as a consequence of swelling bituminised waste forms. In their findings the outer silo walls were not affected by this process.

The main degradation of bitumen matrices that will lead to release of radionuclides in the waste is expected to be water uptake and swelling. The time taken for water uptake and how this affects the matrix is very uncertain, however. Some indication of how effective a bitumen matrix is as a barrier for radionuclide transport can be obtained from leaching experiments. Extrapolation of results from such leaching experiments conducted over periods, that are short in a waste disposal context, indicates that it could take several thousand years before all radionuclides have leached out of the bitumen matrix in a 200-litre steel drum (Pettersson and Elert 2001). A more reasonable timescale for the release of radionuclides is, according to Pettersson and Elert (2001), several hundred up to a thousand years. In SR-PSU it is assumed that the radionuclides will be released from the bitumen matrix within 100 years after closure of the repository.

### **Ion-exchange resins and filter aids**

The most abundant organic materials in the SFR repository are different forms of ion-exchange resins used for decontamination of various process waters. Ion-exchange resins are found in all waste vaults, although most of the resins are found in 1BMA and the silo. The ion-exchange resins are solidified in cement or bitumen and packaged in steel moulds, concrete moulds or steel drums. In the BTF vault, the situation differs from the other waste vaults in that the ion-exchange resins are stored unconditioned, but dewatered, in concrete tanks.

Ion-exchange resins may undergo degradation via chemical, radiolytic and microbial processes. The degradation of ion-exchange resins may in turn have an impact on the performance of the SFR repository.

Ion-exchange resins consist of polystyrene chains with amines as active groups in anion exchangers and sulphonic groups in cation exchangers (Allard and Persson 1985). Cation exchangers can also consist of carboxylic groups, weaker than sulphonic groups, with a polyacrylate backbone (Allard et al. 2002). It has been shown that ion-exchange resins are chemically inert under the chemical conditions anticipated in SFR (Bradbury and Van Loon 1997, Van Loon and Hummel 1999a, b), so no organic degradation products are expected or are considered relevant from their chemical degradation. Under the conditions prevailing in SFR, degradation of the ion-exchange resins containing carboxylates as the functional group have been shown not to degrade and are therefore considered to be stable (Allard et al. 2002). Ion-exchange resins containing carboxylates as the functional group are thought to degrade, if any degradation takes place, via decarboxylation and not via cleavage of the polymeric structure (Allard et al. 2002). Savage et al. (2000) noted that experimental data indicate that ion-exchange resins should be stable at the low temperatures and radiation doses that will exist in SFR 1.

The radiolytic decomposition of ion-exchange resins could split off functional groups during irradiation in addition to hydrogen gas evolution. Among the most common types of ion-exchange resins used in the Swedish nuclear reactors are cation exchangers with a sulphonic acid functional group and anion exchangers with tertiary amines as the functional group. During irradiation of sulphonic acid type ion-exchange resins, sulphate ions are formed (which may impact the integrity of concrete structures in the repository). Irradiation of tertiary amine functional groups of anion-exchange resins will form a mixture of trimethyl amine, dimethyl amine, methyl amine, ammonia and nitrogen. The radiation field in SFR is regarded to be low enough not to influence the stability of the ion exchange resins.

The styrene backbone of the ion-exchange resins deposited in SFR is aerobically degradable by different types of bacteria (Omori et al. 1974, 1975, Sielicki et al. 1978, Shirai and Hisatsuka 1979, Grbić-Galić et al. 1990). It has also been shown to be degraded by an anaerobic consortium of microorganisms (Grbić-Galić et al. 1990). Whether microbial degradation will occur under the conditions expected in SFR remains uncertain. SKB does not regard the process as a major degradation pathway.

Dario et al. (2004) reported that a filter aid (acrylonitrile polymer) was degraded 15% in less than two months. On the other hand, there was little degradation of the ion-exchange resin (metacrylic polymer) under the experimental conditions and degradation time considered.

### **Evaporator concentrate**

Some waste types, e.g. the bitumen conditioned ion-exchange resins in BMA, may contain evaporator concentrates and these concentrates may contain a significant amount of highly soluble salts. Sodium sulphate may be released from the salts and potentially affect adjacent cement waste matrices and concrete packaging in the repository through the formation of the expanding mineral ettringite.

In the waste compartments in 1BMA where the waste type F.17 is deposited elevated concentrations of sulphate could appear locally that could cause ettringite formation in the concrete barriers. For a further discussion see Section 6.3.8.

Table 6-2 show the composition of the waste in the 1BMA compartments where the waste type F.17 is deposited.  $C_3AH_6$ , in column 4 of Table 6-2, are reactive cement minerals which have the capacity to react with the sulphate released from the evaporator concentrate and form ettringite within the waste domain. Column 8 shows the total amount of evaporator concentrate in the compartments estimated from the expected number of F.17 waste packages and the average amount of evaporator concentrate per waste package (SKB 2013a).

### **Trash and scrap metal**

Large quantities of metals will be present in the SFR repository, mainly carbon steel, stainless steel, aluminium and zinc. Carbon steel and stainless steel derive from various scrap metal, waste packaging and reinforcement in concrete packaging and concrete structures.

**Table 6-2. Inventory of cement and evaporate concentrate in the compartments containing the waste type F.17 in 1BMA (Initial state report).**

1	2	3	4	5	6	7	8	9	10
Compartment no	Concrete [kg]	Cement [kg]	C <sub>3</sub> AH <sub>6</sub> [mol]	Mono-sulphate [mol]	Capacity sulphate [mol]	F.17	Concentrate [kg]	Sulphate waste [mol]	Capacity/Waste
3	2.65·10 <sup>5</sup>	2.02·10 <sup>5</sup>	1.28·10 <sup>4</sup>	5.14·10 <sup>4</sup>	1.41·10 <sup>5</sup>	144	17,280	1.96·10 <sup>4</sup>	718%
6	2.65·10 <sup>5</sup>	2.05·10 <sup>5</sup>	1.30·10 <sup>4</sup>	5.20·10 <sup>4</sup>	1.43·10 <sup>5</sup>	259	31,080	3.53·10 <sup>4</sup>	404%
10	6.47·10 <sup>5</sup>	2.51·10 <sup>5</sup>	1.92·10 <sup>4</sup>	7.68·10 <sup>4</sup>	2.11·10 <sup>5</sup>	211	25,320	2.88·10 <sup>4</sup>	734%
11	3.92·10 <sup>5</sup>	1.62·10 <sup>5</sup>	1.21·10 <sup>4</sup>	4.85·10 <sup>4</sup>	1.33·10 <sup>5</sup>	211	25,320	2.88·10 <sup>4</sup>	463%
12	3.95·10 <sup>5</sup>	1.62·10 <sup>5</sup>	1.21·10 <sup>4</sup>	4.87·10 <sup>4</sup>	1.34·10 <sup>5</sup>	211	25,320	2.88·10 <sup>4</sup>	465%
13	3.93·10 <sup>5</sup>	1.61·10 <sup>5</sup>	1.21·10 <sup>4</sup>	4.84·10 <sup>4</sup>	1.33·10 <sup>5</sup>	212	25,440	2.89·10 <sup>4</sup>	460%
14	4.21·10 <sup>4</sup>	2.86·10 <sup>4</sup>	1.86·10 <sup>3</sup>	7.46·10 <sup>3</sup>	2.05·10 <sup>4</sup>	53	6,360	7.23·10 <sup>3</sup>	283%
15	4.21·10 <sup>4</sup>	2.86·10 <sup>4</sup>	1.86·10 <sup>3</sup>	7.46·10 <sup>3</sup>	2.05·10 <sup>4</sup>	53	6,360	7.23·10 <sup>3</sup>	283%

**Table 6-3. Corrosion rates for carbon steel, for stainless steel and for Al and Zn. Data taken from the Data report.**

Conditions in the repository	Corrosion rate for carbon steel (µm/yr)	Corrosion rate for stainless steel (µm/yr)	Corrosion rate for Al and Zn (µm/yr)
Alkaline aerobic conditions	0.1	0.02	
Alkaline anaerobic conditions	0.05	0.01	1,000
Non-alkaline, near-neutral pH, aerobic	60	0.3	
Non-alkaline, near-neutral pH, anaerobic	2.8	0.2	

A number of parameters will affect the corrosion rate, in particular metallurgical and environmental factors. The period of aerobic corrosion will be followed by a period where the oxygen will have been consumed and the repository is oxygen-free. Anaerobic corrosion will then take place. From estimations of available metals and initial oxygen trapped in the repository, it is assumed that all the available oxygen will be consumed within 5 years, depending on waste type, after repository closure (Duro et al. 2012).

Corrosion of the metals in the repository will lead to changes in properties in metal packaging, reinforcement, and metal waste (either unconditioned or embedded in concrete). Anaerobic corrosion with water will produce hydrogen gas, which may cause volume changes as the pressure increases.

Sulphate-reducing bacteria form sulphide, which can have a corrosive effect on metals. Under special conditions, with local water flows near metal surfaces and in the presence of organic compounds from the repository, some pitting can occur but such sulphide-related corrosion does not cause more gas production than general corrosion.

Corrosion of metal waste will also govern the release of induced radioactivity, for example in the BWR reactor pressure vessels in SFR 3. A uniform average corrosion rate has been chosen to represent the process in the SFR repository, see Table 6-3.

Corrosion of Al and Zn will be rapid, and all of the metal is assumed to be corroded within a few years after the repository becomes water-saturated, see the Section “Gas formation” below.

### **Water composition**

#### **Cement barrier porewater**

The inflowing groundwater has a pH of 6.6–8.0 and contains significant amounts of CO<sub>3</sub><sup>2-</sup>, SO<sub>4</sub><sup>2-</sup>, Ca<sup>2+</sup> and Mg<sup>2+</sup>, see Table 6-1. However, when mixing in the near-field the reference composition of cement porewater is taken to be formed, as presented in Table 6-4.

**Table 6-4. Cement porewater components (mg/L).**

	Fresh cement porewater <sup>a)</sup>	Leached cement porewater <sup>b)</sup>
SO <sub>4</sub> <sup>2-</sup>	3.84	1.92
Cl <sup>-</sup>	2.13	71
Na <sup>+</sup>	644	69
K <sup>+</sup>	3,237	3.9
Ca <sup>2+</sup>	36	800
Si as SiO <sub>2</sub> (aq)	22.4	0.084
Al <sub>tot</sub>	1.08	0.054
OH <sup>-</sup>	1,938	612
pH	> 13	12.5
Ionic strength (M)	0.12	0.061

a) Lagerblad and Trägård 1994.

b) Engkvist et al. 1996.

The chemical evolution of the concrete barriers over time is further described in Section 6.3.8. The key impacts of the cement on the aqueous speciation are the high pH and the increase of ionic strength. As soon as the repository resaturates, these conditions arise from the leaching of alkali metal hydroxides, and later from the leaching of calcium hydroxide (portlandite). The cement barriers in SFR are made of Degerhamn Anläggningscement. The pH of fresh SFR Degerhamn Anläggningscement porewater is around pH 13, with an ionic strength of ~0.1 M dominated by K<sup>+</sup>, Na<sup>+</sup> and OH<sup>-</sup> ions (Lagerblad and Trägård 1994) (Table 6-4), while the pH is 12.5 during the portlandite phase and the ionic strength is ~0.06 M, dominated by Ca<sup>2+</sup> and OH<sup>-</sup> ions (Engkvist et al. 1996). When the portlandite has leached, incongruent dissolution of calcium silicate hydrate phases will occur resulting in a gradual lowering of the pH to about 10 (SKB 2008a).

The Eh of the cement barrier porewater is expected to become reducing soon after closure, as oxygen introduced during the open phase is consumed by microbial respiration and the iron is corroded by water (Duro et al. 2012).

### Waste/waste packaging leachate

In the case of cement-conditioned waste, the leachate is expected to be dominated by the soluble species in the cement and the pH will be affected by the waste and the amount of cement present, see Table 6-5.

**Table 6-5. Summary of pH regimes for waste vaults. Cells shaded with grey indicate that no further changes are predicted during 100,000 years (Cronstrand 2014). Times refer to AD.**

pH	Date AD								
	1BMA – cement Waste Wall		1BMA – Bitumen Waste Wall		1BLA	1BTF Ash section	2BTF	Silo Waste	Wall
13.0	2,000	2,000	2,000	2,000		2,000	2,000	2,000	2,000
12.5	7,000	6,000	7,000	8,000	2,000	4,000	7,000	26,000	34,000
12.0		22,000		22,000	8,000				
11.5		58,000		50,000	9,000				
10.5					9,200				
9.0					11,000				
7.5					21,000				



### **Fluxes of aqueous species**

Migration of species from the waste and packages will also affect aqueous speciation. Influxes of chloride, sulphate and carbonate and organic complexing agents are important in terms of degradation of the concrete barrier. However, where the waste is conditioned in cement/concrete, the influence of these processes on the barrier will be minimised since the species will react with the conditioning cement and not the concrete in the repository walls.

The release of radionuclides and the salts contained in a bitumen matrix will be dependent on the supply of water. The diffusivity of radionuclides and salt components is very low in intact bitumen. Water supply will therefore only be possible through cracks, bubbles and fissures in the waste matrix.

### **Colloids**

The amount of colloids in the engineered barriers in the silo, BMA, BTF and BRT vaults is assumed to be negligibly small. This is supported by Swanton et al. (2010), as the concrete barriers and the concrete packaging will supply calcium ions, suppressing colloid formation. Furthermore, the calcium content of the intruding groundwater is relatively high, which should also prevent extensive colloid formation in the BLA vaults, where no concrete barriers are present (SKB 2001b). Formation of bentonite colloids is further discussed in Section 6.3.8.

### **Bitumen colloids**

From the discussion in Bruno et al. (2013), as well as evidence from experiments and natural systems, it is concluded that bitumen colloids are likely to occur and would be stable and numerous in cementitious environments. However, the extent of radionuclide complexation by bituminous colloids is expected to be low (Bruno et al. 2013), and therefore their potential contribution to radionuclide transport at SFR is deemed to be limited. Hence, no further consideration in PSU radionuclide transport calculations would appear to be appropriate in the light of the present evidence.

### **Redox**

The evolution of the redox conditions in SFR is of high relevance in the safety assessment. Redox conditions influence the speciation of redox-sensitive elements such as selenium, technetium, neptunium and plutonium, and a change in oxidation state influences their sorption behaviour. An assessment of the evolution of the redox conditions in SFR 1 has therefore been performed. The approach followed is based on evaluation of the evolution of redox conditions and reducing capacity in 12 individual waste packages selected as being representative for most of the different types of waste packages present or planned to be deposited in SFR 1. The redox-conditions in SFR 3 are assumed to be the same as in SFR 1 due to the presence of concrete and iron. Different geochemical reactions of relevance to redox in the system have been considered in the model.

According to the results, the corrosion of steel-based material present in the repository can keep the system under reducing conditions for a long time. In the initial step after repository closure, the microbially mediated oxidation of organic matter rapidly causes the depletion of oxygen in the system. Subsequently reducing conditions prevail in the system and hydrogen is generated by anoxic corrosion of steel. The redox potential in the vaults changes from oxidising (due to the initial oxygen content) to highly reducing within 5 years after repository closure. The redox potential imposed by the anoxic corrosion of steel and hydrogen production is approximately  $-0.75$  V at pH 12.5. If it is assumed that the system responds to the Fe(III)/magnetite system, and considering the evolution of pH due to degradation of the concrete barriers, the redox potential would be about  $-0.7$  V (Duro et al. 2012).

### **Radionuclide speciation**

The major factors affecting radionuclide speciation are pH, Eh, and the concentration and type of other chemicals in the system, including the presence of complexing agents. The pH is fundamentally important, as it defines the balance between protons and hydroxyl ions in the solution. Under the alkaline conditions found in most of the waste vaults, both deprotonation and complexation by

hydroxyl ligands increase the abundance of anionic species. Eh is of critical importance for redox-sensitive elements, and the low Eh in SFR (Duro et al. 2012) favours reduced oxidation states. A key example of a redox-sensitive element in wastes is iron, which corrodes from Fe(0) to Fe(II) and/or Fe(III), depending on the Eh/pH conditions. Technetium is another important example and can be reduced from Tc(VII), as  $\text{TcO}_4^-$ , to  $\text{Tc(IV)O}_2$ . The oxidation state therefore affects the aqueous speciation and solubility of an element, as well as its reactions with other species. Thermodynamic modelling is required to account for all the different interactions occurring within a complex system such as the SFR repository. The speciation controls exerted by pH, Eh, dissolved ions and the presence of complexing agents are important because they control a) the overall solubility of each element present with respect to chemical precipitation in the solution, b) the interactions of the element with surface sorption sites, and c) the potential for the species to migrate with groundwater flow.

Given the modelled redox conditions within the SFR repository, thermodynamic modelling suggests that e.g. Se, Tc, Np and Pu are present in their lower oxidation states as Se(-II), Tc(IV), Np(IV), Pu(III) and Pu(IV) (Duro et al. 2012). Aqueous speciation will affect the amount, composition, volume, pressure and degree of saturation of gases, as the saturation limit of dissolved gas is affected by pH and aqueous speciation. An example of this is the solubility of  $\text{CO}_2$  in water, which increases at higher pH because the  $\text{OH}^-$  ions shift the carbonate equilibria towards  $\text{CO}_3^{2-}$ .

### ***Metal corrosion***

The initial rapid corrosion (under oxic conditions) of aluminium and zinc will dominate the corrosion processes shortly after closure of the repository. When this corrosion is completed, corrosion of iron is the dominant corrosion process during the subsequent period. The redox conditions in all waste vaults will be reducing and the corrosion rates are assessed as 0.05 and 0.01  $\mu\text{m}/\text{yr}$  for carbon steel and stainless steel, respectively.

### ***Organic complexing agents***

A majority of the organic materials in SFR, such as ion-exchange resins, cellulose and detergents, are derived from nuclear installations and to a lesser extent from the structural parts in the repository, e.g. concrete additives. A limited amount of the organic material originates from research, industry and healthcare. The organic substances could be important due to their own capacity to complex radionuclides or due to degradation processes that could result in the formation of new complexing organic ligands not originally present in the repository.

Many of the organic substances in the waste may undergo degradation through a combination of chemical, physical, radiolytic and microbial processes. Consequently, the degradation of the organic material may have a significant impact on the performance of the SFR repository.

### ***Detergents***

Chemicals used for decontamination and cleaning include: DTPA (diethylene triamine pentaacetic acid), EDTA (ethylene diaminetetraacetic acid), NTA (nitrilotriacetic acid), gluconate, citric acid and oxalic acid. Multidentate chelating agents such as DTPA, EDTA and NTA have widespread application in the nuclear industry for decontamination of reactors and equipment (Ayres 1971). Aminopolycarboxylic acids, compounds containing several carboxyalkyl groups bound to one or more nitrogen atoms, are especially versatile because of their ability to form stable, water-soluble complexes with a wide range of metal ions. As reported by Means and Alexander (1981), it appears that the strength of a metal-chelate complex greatly depends on the charge of the complexing ligand. Complexes are weakest for acetic acid, which is not a chelating agent because it possesses only one acidic functional group. For a given metal, the stability of the complexes generally decreases in the order  $\text{DTPA} > \text{EDTA} > \text{NTA} > \text{citric acid} > \text{oxalic acid} > \text{acetic acid}$ . The structure of NTA is more favourable to form stable complexes with cations than citrate, due to the availability of the N-atom electron pair in the chelating process. Thus, NTA is a tetradentate ligand, even though it possesses only three ionisable functional groups. For the same reason, EDTA is a hexadentate ligand, and DTPA is octadentate.

Chemical degradation of the aforementioned organic ligands is not expected to be significant. Chemical conditions more severe than those occurring in the repository might be necessary (Keith-Roach 2008). Nevertheless, those organic substances may themselves be relevant due to their own capacity for complexation with radionuclides (Hummel et al. 2005).

## Cellulose

Under the conditions prevailing in most of the waste vaults, i.e. high pH and a  $\text{Ca}^{2+}$  rich environment, cellulose will degrade to shorter chained organic compounds. Of the acids released in the degradation of cellulose, 3-deoxy-2-C-hydroxymethyl-D-erythro-pentonic acid ( $\alpha$ -ISA) and 3-deoxy-2-C-hydroxymethyl-D-threo-pentonic acid ( $\beta$ -ISA) are the most abundant (see Figure 6-10). A greater proportion of ISA is formed from degradation in the presence of calcium ions than in the presence of sodium ions (Machell and Richards 1960).

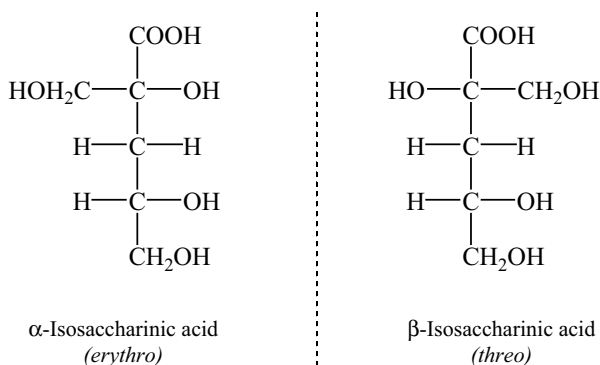
Analyses have confirmed the presence of both isomers of ISA in leachates from the degradation of cellulose in the presence of Ordinary Portland Cement (OPC)/Blast Furnace Slag and Nirex reference vault backfill (NRVB), together with a number of other products (Greenfield et al. 1993, 1994). Besides ISA, different carboxylic acids and hydrocarboxylic acids have also been identified in other alkaline degradation studies (Glaus et al. 1999, Pavasars 1999, Bourbon and Toulhoat 1996).

Among the degradation products of cellulose, ISA has been identified conclusively as a key component and one of the organic compounds with the greatest impact on the speciation and mobility of radionuclides in SFR. The other compounds represent only a small percentage of the total dissolved organic compounds, although all of them could be acids with significant complexing capacity.

The rate of alkaline degradation is one of the factors determining the concentration of cellulose-derived complexants such as ISA in solution (Chambers et al. 2002, Askarieh et al. 2000). Recent experiments on cellulose degradation (Glaus and Van Loon 2008) were carried out under alkaline and aerobic conditions and at room temperature over a time span of 12 years. In view of the new data and the model presented in Glaus and Van Loon (2008), the range of uncertainty for complete degradation of cellulose under SFR conditions can be narrowed down to a best estimate of 1,000 to 5,000 years. Calculations based on the cellulose inventory in SFR suggest that all cellulose will be consumed within some 5,000 years after resaturation of the repository (Keith-Roach et al. 2014).

## Cement additives

Cement additives are used in small amounts (approximately 1%) in different concretes. Water reducers (WRA) include lignosulphonates and sulphonated naphthalenes, formaldehyde and hydrocarboxylic (HC) acids. These additives disperse the cement particles due to their dipolar charging properties and represent 0–0.1% by weight of the concrete mixture. The additives used in the structural concrete in SFR1 are Sika plastiment BV-40 (concrete plasticiser) and Sika retarder (cement hydrating retarder); the amount of plasticiser varies between 0.05–0.5% of the cement weight depending on the concrete recipe. Generally 0.2% retarder is added to the cement weight. The Sika plastiment BV-40 consists of a blend of lignosulphonates. Lignosulphonates have been shown not to significantly reduce the sorption of  $\text{Ni}^{2+}$ ,  $\text{Eu}^{3+}$  and  $\text{Th}^{4+}$  at the concentrations used in the structural concrete in SFR (Glaus and Van Loon 2004).



**Figure 6-10.** Fischer projection of the two diastereomers of isosaccharinic acid.

### **Influence upon sorption**

As pointed out above, the waste and, in some cases the cement/concrete, can introduce a range of soluble organic substances into the porewater. Depending on their concentrations, these substances may have a significant effect on sorption.

The concentrations of various complexing agents present in the SFR waste are presented in Table 3-7 and Table 3-9 in Keith-Roach et al. (2014).

The various processes of relevance to the impact of these organic substances on radionuclide sorption are discussed in the **Waste process report**. Complexation of organic substances with radionuclides is important, but so is the competition of the abundant  $\text{Ca}^{2+}$  ions for the organic ligands as well as the sorption behaviour of the organic substances themselves.

In view of these different interactions, defining reduction factors for radionuclide sorption is difficult, because these factors would depend not only on the concentration of organic substances but also on the  $\text{Ca}^{2+}$  concentration (for a definition of sorption reduction factors see the **Data report**). Hence, the potential impact of organic complexing ligands is assessed as far as possible by defining limiting concentrations of organics below which no effects are expected. The limiting concentrations and reduction factors presented in Table 6-6 are largely based on analogies and approximations since complete data sets for all relevant radionuclides and complexing agents are missing.

The aqueous concentrations of complexing agents present in the waste from the date of closure have been calculated by Keith-Roach et al. (2014). As regards the organic complexing agents deposited in SFR, the impact on sorption is greatest during the first 1,000 years. As time goes on, these complexing agents will be transported away, reducing their concentrations within the waste domain and their potential impact on sorption.

**Table 6-6. Limiting no-effect concentrations and sorption reduction factors for organic complexants exceeding these concentrations. Radionuclides are grouped where appropriate. Those radionuclides where information only applies by analogy are indicated in italics, [org] stands for any of the compounds indicated above. A realistic (best estimate) value is given for all radionuclides. Reduction factors apply to all sorption values (i.e. best estimate and upper/lower limits). Reduction factors refer to each 10-fold increase of [org] above the indicated level; concentrations above 10 mM are not considered.**

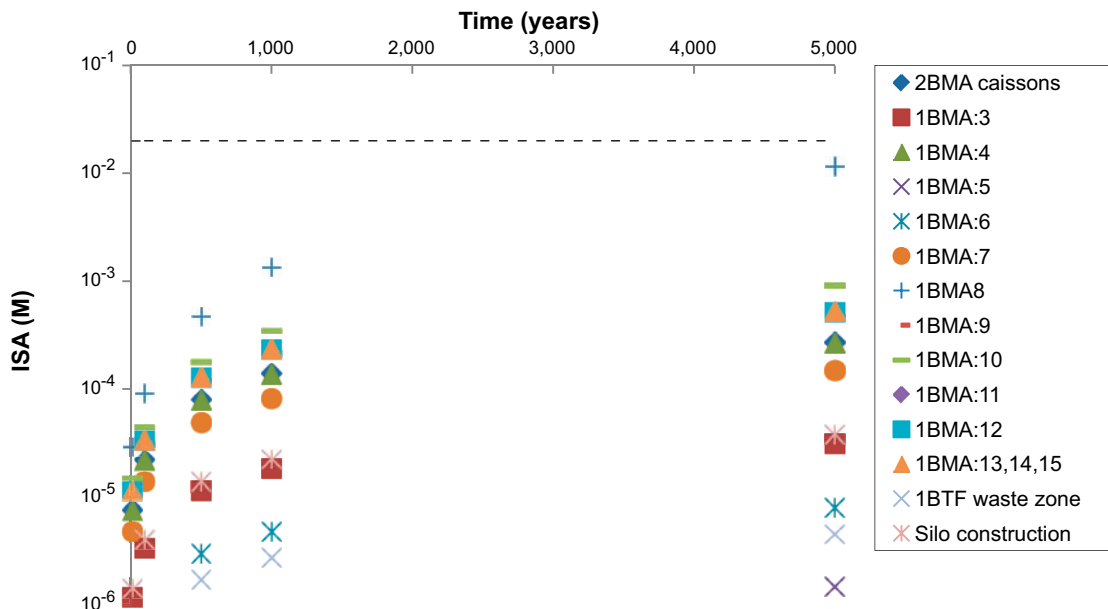
<b>Radionuclide (oxidation state)</b>	<b>No-effect concentration and comments</b>	<b>Reduction factor</b>
Ag(I)	[EDTA, NTA] > [Ca] no effect expected for other organics	– –
$^{14}\text{C}$ , carbonate species	isotope exchange, no effects expected	1
$^{14}\text{C}$ , $\text{CH}_4$ , organic acids	not relevant: $K_d = 0$ assumed	1
Ca (radioactive isotopes)	no effects expected	1
<i>Cd(II)</i>	no effects expected for [org] < 10 mM	10
Cl(-I), I(-I)	no effects expected	1
Cs(I)	no effects expected	1
<i>Ac(III)</i> , <i>Eu(III)</i> , <i>Am(III)</i> , <i>Cm(III)</i> , <i>Ho(III)</i> , <i>Pu(III)</i> , <i>Sm(III)</i>	no effects expected for [org] < 1 mM	10
Mo(VI), Se(VI), Tc(VII)	no effects expected (see text)	1
<i>Nb(V)</i>	no reduction of sorption at [org] < 0.1 mM	10
Ni(II), <i>Co(II)</i>	isotope exchange, no effects expected	1 (10)
Pb(II), <i>Pd(II)</i>	no reduction of sorption at [org] < 0.02 mM	100
Th(IV), <i>Np(IV)</i> , <i>Pu(IV)</i> , <i>U(IV)</i> , <i>Pa(IV)</i> , <i>Tc(IV)</i> , <i>Zr(IV)</i> , <i>Sn(IV)</i>	no reduction of sorption at [org] < 0.1 mM	100
<i>Np(V)</i> , <i>Pu(V)</i>	no effects expected for [org] < 1 mM	10
<i>Pa(V)</i>	no reduction of sorption at [org] < 0.1 mM	100
Se(-II)	not relevant: $K_d = 0$ assumed	–
Se(IV), <i>Po(IV)</i>	no reduction of sorption at [org] < 0.1 mM	10
Sr(II), <i>Ba(II)</i> , <i>Ra(II)</i>	no reduction of sorption at [org] < 10 mM	10
U(VI), <i>Pu(VI)</i>	no reduction of sorption at [org] < 0.5 mM	10

### Cellulose degradation products (ISA)

The situation is somewhat different for ISA, as it is formed by the alkaline degradation of cellulose, which means that its concentration will increase as cellulose degradation proceeds. ISA has also been shown to sorb on cement (Van Loon and Glaus 1998), decreasing the aqueous concentration but also delaying the removal of ISA so that its influence on sorption spans a longer time period than in the case of non-sorbing complexing agents. The evolution of the ISA concentration in 1BMA is shown in Figure 6-11. With the calculated concentrations of ISA, and with fully degraded cellulose, the sorption of certain radionuclides will be affected. According to Keith-Roach et al. (2014), the concentration of ISA reaches such values that the sorption is affected before all cellulose is degraded. Hence, the sorption reduction is included in the radionuclide transport calculation even at times before full degradation of cellulose, see Figure 6-11.

### Microbiology

Biological processes can take place from  $-20^{\circ}\text{C}$  up to above  $113^{\circ}\text{C}$ , where in general all life processes stop. Life is also possible within a wide pH range, from pH 1 up to above pH 12 (Pedersen et al. 2004, Yumoto 2007, Brazelton et al. 2013). Assuming that there will be no microenvironments, the pH in the water in contact with the waste is expected to follow the concrete degradation stages, i.e. initial pH 13.3, which rapidly decreases to 12.5 in the concrete-containing waste vaults. Microbial growth will increase during the saturation phase due to the input of energy (e.g.  $\text{H}_2$ , which is the main energy source for sulphate-reducing bacteria) and other dissolved nutrients, but will slow down when saturation is reached and the recharge ceases. According to the modelling performed by Cronstrand (2014), hyperalkaline conditions will prevail when saturation is reached and these conditions will last for a long time. During that period, microbial activities are expected to slow down significantly. As the pH in SFR decreases over time, the influence of microbial processes will increase in magnitude concomitantly and could result in a further decrease in pH due to acidogenic activity such as fermentation. It has been shown by Small et al. (2008), among others, that microniches have a great potential to develop in such a heterogenic environment as SFR even though hyperalkaline conditions will dominate in all waste vaults. One important mechanism is the likely formation of microbial biofilms on the waste surfaces and on the surfaces inside the packaging.



**Figure 6-11.** The evolution of ISA concentrations in the 1BMA compartments (denoted 1BMA:X), the 2BMA caissons, the silo and 1BTF over time. Note sorption of ISA to available hydrated cement has been taken into account (Keith-Roach et al. 2014).

The amount of organic carbon, nutrients and electron acceptors in the water interacting with the waste influences the microbial activity. Of great importance is the availability of electron acceptors, such as oxygen, nitrate, ferric iron, sulphate and carbon dioxide. SFR is rich in nutrients and energy, and these components will not be limiting for microbial activity *per se*. The magnitude, direction and distribution of water flow in the different waste vaults will influence the transport of microbes and, much more importantly, the transport of electron acceptors to, and degradation products from, microbes dwelling in the SFR waste form locations. The most favourable position for microbes, with respect to available energy, is inside the BLA packages with a large amount of organic waste. However, restricted availability of electron acceptors and build-up of toxic degradation products may reduce the diversity, but not necessarily the activity of remaining organisms that can proliferate inside packages. Bitumen can be degraded by microbes and is therefore a possible substrate for microbial activity, but only to a minor extent in BLA, as the dominating substrate is cellulose. The growth of microbes will predominantly occur on bitumen surfaces inside waste packages, locally generating large numbers of microbes. The availability of electron acceptors will control microbial processes inside the waste packages.

Microbial growth is possible in a waste form that has been solidified with cement (Gorbunova and Barinov 2012) and on concrete structures. This diversity and activity may be significant if an advective flow supplies the microbes with electron acceptors, removes degradation products and leaches the concrete. The effect may be less significant under stagnant hydraulic conditions. Microbial biofilms can develop on the surfaces of bitumen-solidified waste. This growth may be significant if there is an advective flow to supply the microbes with electron acceptors and remove degradation products. The bitumen will be degraded at a slow rate if conditions are anaerobic; access to oxygen is then an important boundary condition. Degradation is much higher under aerobic conditions.

Non-conditioned waste has the greatest potential for microbial degradation. The organic carbon content of this waste is very high and its pH will be less alkaline than in cement-solidified waste. The large mobility of microbes and waste components inside a package suggests that gas production may become significant there. Microbial growth is possible on the outside of cement packages. The pH gradients will control microbial growth; the limit is not well known.

Microbial corrosion is a well-established process, and pitting corrosion by sulphate-reducing bacteria could rapidly corrode holes in the steel packaging. Growth and corrosion may be significant if there is an advective flow to support microbes locally with sulphate and organic substrates. Microbial growth is possible in the backfill too and may be significant in the presence of an advective flow. The effect will, however, be lower under stagnant hydraulic conditions.

The most important boundary conditions are access to water and the high pH in the repository once it is filled with water, since most of the waste is either encapsulated in concrete/cement or at least in close contact with it. The system is thus buffered with  $\text{Ca}(\text{OH})_2$ , sustaining the high pH. It has been demonstrated that microorganisms could grow and be metabolically active under aerobic as well as anaerobic alkaline conditions, i.e. at pH 10–11 (Pedersen et al. 2004) and even higher pH (Yumoto 2007, Brazelton et al. 2013). However, since growth is slow, the numbers of bacteria will be low and metabolic activity will also be low.

### **Gas formation**

Gas can be formed in the repository by corrosion of metals in the waste, the waste packaging and the rebar in the concrete structures, as well as by microbial degradation of organic material in the waste. Radiation from the radioactive waste can also generate gas by radiolysis of water.

Large quantities of gas can potentially be formed in a repository for low- and intermediate-level waste. In order for the gas to escape into the surrounding rock, gas-conducting passages must be created in the repository. A possible consequence of the pressure build-up that is required to create these passages is fracturing of repository barriers and displacement of contaminated water.

When the repository is closed and pumping ceases, the lower pressure in the repository will allow groundwater to flow in. Total saturation of the silo takes around 25 years, whereas the other vaults are saturated in just a few years (Holmén and Stigsson 2001). Remaining atmospheric oxygen and oxygen dissolved in water in the repository will be consumed by aerobic corrosion of metals or some

other oxygen-consuming process such as microbial degradation of organic matter. Aerobic conditions are therefore only expected to prevail for a short time (Duro et al. 2012). Anaerobic conditions will first develop locally and then gradually spread until they prevail in the whole repository.

### **Gas formation due to corrosion**

When the oxygen in the repository has been consumed, hydrogen gas can be formed by anaerobic corrosion of metals, which is the process that is expected to contribute the largest quantities of gas in low- and intermediate-level repositories. A prerequisite for hydrogen-generating corrosion is a supply of water. This is rarely a limiting factor in an underground repository, and even the initial content of water in the waste and the engineered barriers is often sufficient to generate gas. Theoretically, approximately 1 litre of water is needed to generate 1 Nm<sup>3</sup> (N stands for normal, 0°C and 101.325 kPa) of hydrogen. Another factor that affects corrosion is water chemistry – mainly pH, Eh and the concentration of dissolved salts (Duro et al. 2012). Temperature and radiation level can be of importance in repositories with high-level waste, but are of little importance in repositories with low- and intermediate-level waste. It has also been found that the high pressures that are required in order for the hydrogen gas pressure to significantly inhibit the corrosion rate exceed the pressures needed for the gas to escape through the surrounding barriers (Moreno et al. 2001).

### **Gas formation due to microbial activity**

Microbial processes will utilise hydrogen from corrosion processes in SFR. Hydrogen gas will thereby have a profound influence on the extent and rate of microbial processes in SFR when the pH has fallen enough to allow uninhibited respiration by the microbes. Many microbial processes generate gases such as carbon dioxide, nitrogen, nitrous oxide and methane. Significant pressure build-up can consequently occur as a result of microbial processes. However, gases are also consumed by microbial processes, such as the reduction of CO<sub>2</sub> by 4 H<sub>2</sub> yielding 1 mole of CH<sub>4</sub> from 5 moles of gas (Equation 6-1).

Microbial degradation of organic materials under conditions expected to prevail in SFR 1 after closure has been investigated by Pedersen (2001). Experiments cited there indicate that the rate of gas formation is initially rapid but decreases after the initial phase. According to Pedersen (2001), the environment in SFR 1 is not optimal for microbial degradation, but even a pH as high as 12 is no obstacle to microbial activity. Gas formation due to microbial activity in SFR 1 could be limited by the supply of oxidants and nutrients and the removal of reaction products. A possible positive aspect that could limit total gas formation in the repository is that many microorganisms can utilise hydrogen as an energy source and could thereby reduce the quantity of hydrogen formed by corrosion. This process, which is considered favourable, has not been included in the assessment. However, cellulose degradation rates corresponding to complete consumption in less than 200 years have been assumed in the calculations of gas formation. This is equivalent to a degradation rate of 0.2 mol/kg·year and a gas formation rate of about 2 L/kg·year, assuming that 50% of the gases do not react with repository materials (Rout et al. 2014, Askarieh et al. 2000).

The few experiments that have been done on microbial degradation of bitumen, ion-exchange resins and plastics indicate that the processes are very slow. In the calculations it has been assumed that 0.002 mol/kg·year is degraded, corresponding to a degradation of all material in 15,000 years and a gas formation rate of 0.02 L/kg·year, assuming that 50% of the gases do not react with repository materials (Moreno et al. 2001).

### *Methanogenesis*

Methanogens are found in nearly every anaerobic environment. They can respire across a wide environmental pH range from 4 to 10, although their optimum pH generally ranges from 6 to 8 (e.g. Ferry 1993).

The activity of microbes under anaerobic conditions may eventually lead to significant production of gases such as CH<sub>4</sub>, CO<sub>2</sub> and H<sub>2</sub>. However, autotrophic methanogenesis will also consume gas according to the reaction below:



$^{14}\text{C}$  can be released as  $^{14}\text{CH}_4$  and  $^{14}\text{CO}_2$ , but due to carbonation of the cement present in the near-field, the bulk carbon dioxide will be removed and radioactive  $^{14}\text{CO}_2$ , which will be generated largely by degradation of  $^{14}\text{C}$ -labelled organic compounds within the waste, will be immobilised, subsequently preventing or at least limiting the formation of  $^{14}\text{CH}_4$  by methanogenesis. The potential methanogenesis is not likely to start until the pH has dropped below hyperalkaline values (Ferry 1993). Thus, lowering of pH mitigated by acid production from fermentation by syntrophic bacteria present may activate methanogenesis. However, in a recent study by Brazelton et al. (2013), they observed increased cell amounts over a pH of 12 (Figure 6-12), which could be a contradiction to the general view that microbial growth decreases with increased pH. This opens up the possibility of microbially produced metabolites that could include methane production under hyperalkaline conditions as well.

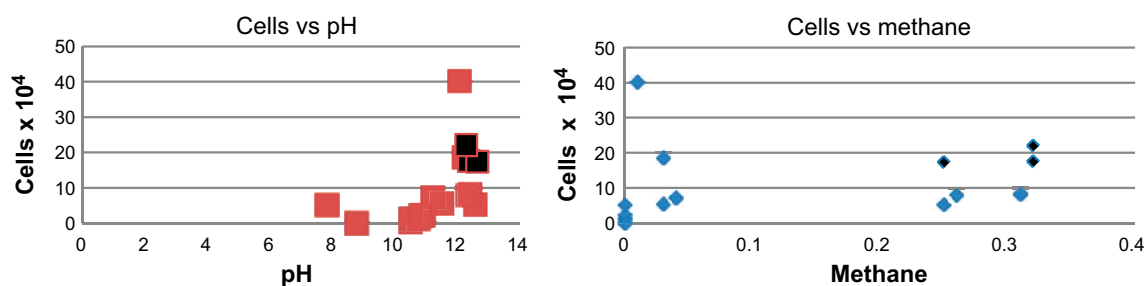
### Gas formation due to radiolysis

Radiation from the radioactive waste in SFR 1 can act on materials and cause formation of gas and species that can affect the water chemistry. The materials in the waste and the immediate environs will be exposed to the greatest amount of radiation. G values, which express the number of molecules formed due to irradiation, are used in calculating gas formation due to radiolysis. G values have been determined experimentally for various materials and types of radiation. The effect of irradiation is proportional to the absorbed dose and dependent on the composition and water content of the material. Inorganic materials are often more stable than organic ones. G values for water have been assumed in the simplified calculations of gas formation due to radiolysis. It has also been assumed that all the energy is absorbed in the water present in the ion-exchange resins, the conditioning material and the surrounding material. Radiolysis of water generates hydrogen and oxygen gases. However, the radiation field in the SFR repository is relatively low and the predicted gas formation even in the wastes is negligible in comparison with the gas formation from metal corrosion (Moreno et al. 2001).

### Calculated gas quantities

The gas formation rates in the silo are calculated separately for structures, packaging, reinforcement in packaging and waste. “Packaging” includes metals used in the packaging of the waste, excluding reinforcement bars in concrete packaging, which are accounted for separately. The category “waste” includes steel and aluminium in the waste. “Structures” includes gas formed from corrosion of reinforcement bars in the concrete structures.

For the first 2.5 years, corrosion of aluminium in the waste will dominate gas formation in the silo (Moreno and Neretnieks 2013). The situation is roughly the same in the 1BMA vault (Moreno and Neretnieks 2013). In the 2BTF and the BLA rock vaults, gas generation is much lower due to the lack of gas-generating materials.



**Figure 6-12.** The samples filled with black are the same in both figures and show that some bacteria are able to produce methane at pH > 12. Methane concentrations are expressed in mg/L. Data plotted from Table 1 in Brazelton et al. (2013).



### **Impact of gas formation**

Gas formation will cause contaminated water to be expelled into the buffer or gravel/sand around the concrete structure and finally into fractures in the rock surrounding the vaults. The amount of water expelled depends on the increased pressure in the vaults caused by the gas generation. The gas cannot escape unless it reaches a sufficient pressure to overcome the capillary forces in the media surrounding the waste. This may be the buffer surrounding the silo or fine fractures in the concrete walls of the different concrete structures. In most cases it is assumed that the pressure that builds up is on the order of 1.5 to 5 m water gauge. The possibility cannot be excluded that contaminated water might be expelled from the repository due to gas pressure build-up. Water expulsion could happen within the first few years due to the rapid corrosion of aluminium. If this happens, the expelled water will contain very limited amounts of radionuclides so the impact will be limited. The 2BMA vault will be constructed in such a way that generated gas will be able to escape from the waste domain without expelling any contaminated pore water.

### **Gas transport**

Gases generated by the above processes will be dissolved in the water according to the solubility equilibrium (Henry's law). Gases dissolved in water can be transported across the waste form to the outer part of the waste by diffusion or advection. If the solubility of the gas is exceeded, bubbles can form. The formation of a differentiated gas phase can produce a two-phase flow. This process, with gas originating from corrosion of the waste, may expel water from the system, resulting in a certain degree of desaturation.

Gas transport through the porous material of the matrices will follow the same laws as gas transport through the backfill and the engineered barriers in the repository.

Transport of gas can only affect the stability of the concrete structures if the gas pressure exceeds the local hydrostatic pressure. The rate of gas generation, which is directly related to the rates of corrosion and organic degradation, has an influence on the rate at which the gas pressure increases. The generation of a gas phase can facilitate transport of gaseous radionuclides.

### **6.3.8 Evolution of engineered barriers**

Several internal and external processes are of importance for the long-term safety of the engineered barriers in the repository. Climate variations and shoreline displacement, as described in Section 6.2, have an impact on the groundwater flow which in turn has an impact on the barriers. Low ground temperatures may lead to the development of permafrost, which if it reaches deep enough can cause freezing of the water contained in the engineered barriers. The durability of the barriers is also affected by the interaction with the groundwater and naturally occurring solutes or agents formed by degradation of the waste in the groundwater (see also Section 6.3.7). Of these processes, the leaching of portlandite and CSH gel caused by contact with groundwater is judged to have the greatest impact on the evolution of the barriers. Finally, the barriers may also be affected by pressure from the waste and its packaging caused by e.g. swelling waste.

#### ***Bentonite barriers***

Bentonite consists mainly of montmorillonite, a clay mineral with plastic properties and a high capacity for ion exchange. As a barrier in a final repository, one of the most important properties of bentonite is its swelling capacity. It gives the material low hydraulic conductivity and also enables the clay to self-heal if fractures, channels or other forms of voids occur.

#### **Montmorillonite transformation**

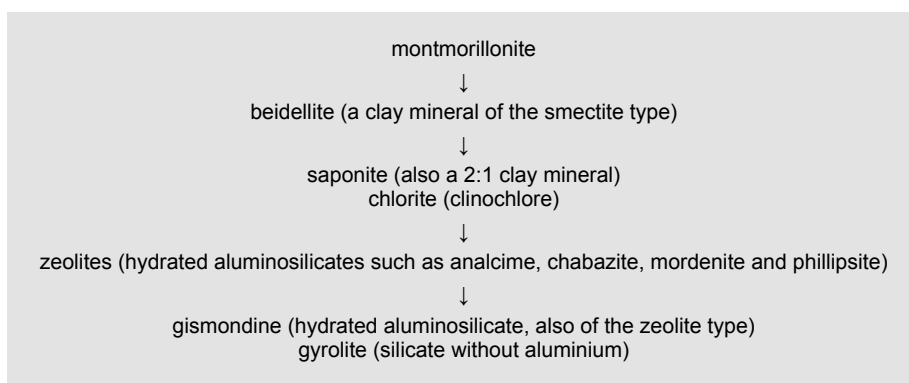
Under normal groundwater conditions (see Table 6-1), montmorillonite is considered to be stable during the time period covered in the assessment of the long-term safety of the repository.

Since the bentonite is placed between concrete components and the rock wall, the groundwater interacting with the bentonite will be significantly more alkaline and have higher contents of  $\text{Ca}^{2+}$ ,  $\text{Na}^+$  and  $\text{K}^+$  than fresh groundwater. Even though the composition of the altered groundwater as well as the processes that control the transformation of montmorillonite are thought to be known, there are still large uncertainties regarding reaction pathways and end products as well as the extent of the reactions and the kinetics of the transformation reaction. A substantial degree of this uncertainty results from the kinetic control of the process.

Cement–clay interactions were studied by Smellie (1998) and in the EU project ECOCLAY-II (EC 2005). Based on the results of this project, a simplified but reasonably realistic view of the transformation process in alkaline solutions should include the processes dissolution of montmorillonite during release of Al, Si, Mg and Na ions followed by precipitation of a range of  $\text{Si}_x\text{O}_y$  (silicates) and aluminosilicates (see Gaucher et al. 2005).

Additional solutes are supplied by the alkaline solution itself. Depending on the degradation state of the concrete, solutions leaching out from cementitious silo components would mainly supply Na, K or Ca ions.

With respect to the results from ECOCLAY-II, Gaucher et al. (2005) summarises the transformations that will take place when montmorillonite is exposed to alkaline solutions (with low concentrations of potassium) as follows:



Considering the uncertainties already mentioned, the reaction sequence above should be regarded as one of several possible sequences. If the alkaline water is rich in  $\text{K}^+$ , illite can be formed, possibly followed by the formation of phillipsite (e.g. Savage 2011).

In comparison with the original present montmorillonite, the secondary phases according to the summary above have a high molar volume but lack the swelling properties of the bentonite. This means that the transformation of montmorillonite can either lead to the available porosity being reduced or completely filled out or to a decrease in or complete loss of swelling pressure. Depending on to what degree the aforementioned transformations occur, a loss of barrier functions cannot be ruled out. Modelling by Gaucher et al. (2005) indicates an almost complete transformation of montmorillonite in the long term, while other studies (e.g. Cronstrand 2007, Fernández et al. 2009) show a considerably smaller effect.

## Cementation

The process of “cementation” has a great impact on the hydraulic, swelling and rheological properties of the bentonite barrier and is directly related to the processes “transformation of impurities”, “dissolution/precipitation” and “montmorillonite transformation”. Cementation is primarily caused by (re-)precipitation of gypsum/anhydrite, calcite and a number of silicate minerals in the bentonite pores. The dissolved components may be supplied from the groundwater or derive from the dissolution of montmorillonite and accessory minerals.

The main effects of cementation include increases in hydraulic conductivity, reduction of swelling capacity and decreases in plasticity. The beneficial properties of bentonite are the result of a

montmorillonite/water interaction; i.e. the formation of a clay gel. This explains why bentonite with a high porosity (about 40%) still has very low hydraulic conductivity. The effect of the precipitation of other minerals in the bentonite pores can be seen as a dilution of the clay gel with relatively large and rigid solids.

### **Bentonite colloid formation**

In a confined space, such as outside the concrete wall of the silo, the water uptake by the bentonite leads to a swelling pressure developing in the bentonite. In case openings occur in the confining walls (e.g. fractures), local swelling of the bentonite can progress until a thermodynamic equilibrium is reached. This free swelling may lead to separation of individual clay particles, which may result in a dispersion of the clay and the clay being transported away with the groundwater as individual colloids.

The dispersion behaviour of the montmorillonite is strongly dependent on the valence and concentration of ions in the pore space. Dispersion (formation of a clay sol) from aggregated clay (clay gel) is primarily relevant in the presence of diluted groundwater and especially at low concentrations of divalent cations in the groundwater ( $\text{Ca}^{2+}$ ,  $\text{Mg}^{2+}$ ).

For the first 1,000 years after closure, the  $\text{Ca}^{2+}$  concentrations in the interface between bentonite and shotcrete are predicted to be high enough to avoid clay dispersion forming a clay sol (Birgersson et al. 2010, 2011, Gaucher et al. 2005).

### **Mobility of colloids**

Stable colloids in 1BMA can be transported with the groundwater through fractures and pores in the barriers. The extent of the transport and filtration of colloids depends on both the flow rate and the physical properties of the flow path and the colloids. The main mechanism of filtration is “(pore) filtration”, when colloids are too large to pass through the apertures, and “sorption”, when colloids attach to solid surfaces through for example electrostatic, van der Waals, physical or hydrophobic interactions. Another relevant process is “ripening”, an increase in pore surface roughness by colloid deposition which increases the probability for further colloid deposition. The sorption process is mainly dependent on solution and surface chemistry, while other transport mechanisms depend on the size and density of colloids as well as pore structure and flow rate. Colloid filtration can occur via either mechanical or electrostatic processes (e.g. Swanton et al. 2010).

For most colloids, the transport through compacted bentonite is negligible, due to the low hydraulic conductivity and the small pore sizes. Under normal conditions no advective flow is expected and the diffusive transport of most colloids is not normally relevant.

At present, it is difficult to decide which properties of relevance for release and filtration of colloids are possessed by the sand/bentonite mixture (90/10) which is placed under the concrete silo and which will also be placed on top of the silo at closure. The sand that will constitute the top layer of the backfill above the silo is, however, not expected to constitute an efficient filter, due to the large pore size and the relatively limited reactivity of the backfill material.

### **Montmorillonite–iron interaction**

Several parts of the repository contain large amounts of Fe(0), which is not thermodynamically stable under repository conditions. The anaerobic corrosion that is expected to occur after closure of the repository will produce Fe(II), that can then react with the available barrier materials as well as with constituents dissolved in the pore water. Fe-bentonite interaction is a complex process which is not yet well understood.

An important consideration for the silo is that the iron and steel that occurs there is contained in concrete and/or cementitious grout. This means that corroding iron will primarily be in contact with cement and the effect on bentonite will depend on the transfer of dissolved Fe(II) through the cement mass. It can be expected that this transfer will be small enough to make the process non-significant in comparison with the interaction between bentonite and alkaline pore water from cement-based grout and concrete.

### **Piping and erosion in the bentonite surrounding the concrete silo**

After closure, the drainage of water from rock surfaces will fill the drainage system. Water can enter the unsaturated bentonite filling either from points in the drainage system or through fractures in the rock surface not covered by the drainage system. Since there is no swelling pressure that can withstand the water pressure, water can enter into the bentonite faster than the bentonite can handle, which may lead to water-filled channels forming in the bentonite. These channels will penetrate the bentonite and eventually end up out in the top backfill of the silo. Water transport in a channel will erode the bentonite which then follows the water flow through the channel and out into the top backfill. The erosion will continue until the open parts in the silo available for water are filled with water and water pressure equilibrium with stagnant water is reached in the silo and surrounding rock. The erosion channels may then self-seal.

Piping is regarded as a hydraulic process with water transport through a channel or a pipe that is maintained as long as the pore pressure is equal to, or exceeds, the swelling pressure in the surrounding bentonite. The flow rate is related to the hydraulic gradient and the radius of the channel.

When the drainage of the rock around the silo is terminated and the silo closed, the water pressure will increase until it either reaches the hydrostatic water pressure at the position equal to the silo depth (64–133 m u h) or until the water penetrates the bentonite barriers. Since the bentonite barrier in the silo has a swelling pressure that is not high enough to withstand the water pressure at silo depth (0.64–1.33 MPa), piping will most likely occur in the bentonite with subsequent bentonite erosion. An alternative is that piping does not occur due to valve formation in the bentonite, which means that the bentonite could be sealed locally and this can instead lead to the formation of closed water pockets (see also Börgesson et al. 2014).

Both processes lead to a local loss of bentonite and the formation of an open channel or void. The question is then how well this void is sealed by the swelling bentonite. It is possible that bentonite erosion will continue until the silo is filled with water or the pressure gradient has moved from the rock/bentonite interface into the bentonite barrier. The worst case is if the erosion creates an open hemisphere around the inflow point. A finite element calculation of self-sealing of a spherical void with a radius of 0.5 m, arbitrarily chosen by the bentonite thickness, has been made (Börgesson et al. 2014). Although the results cannot be used without reservation, they suggest that the bentonite is relatively unaffected close to the concrete silo, which means that the sealing function still works for half a metre of the bentonite filling.

Based on the study in Börgesson et al. (2014), it is judged unlikely that piping and erosion will have a significant impact on the performance of the bentonite barrier.

### **Mechanical processes in the silo bentonite**

The bentonite barrier around the silo was installed directly after the silo was constructed. Since the silo is kept open during the first ~50 years of operation, the rock wall surrounding the silo is provided with drainage which prevents water from entering the bentonite. After closure, the repository is filled with water and the clay absorbs water.

When the bentonite absorbs water, it will start swelling and after full water saturation, a swelling pressure of about 100 kPa is expected. With time, ion exchange in the clay between sodium and  $\text{Ca}^{2+}$  will transform the original Na-bentonite to a Ca-bentonite. This type of ion exchange may lead to a reduction in swelling pressure of up to a factor of five for the relevant dry density (about  $1,000 \text{ kg/m}^3$ ) (Börgesson et al. 2014), a process that could cause a subsidence in the bentonite.

### **The impact of gas on the silo bentonite barrier**

There are a number of processes that generate gas in SFR. The main source is corrosion of metal components, in particular reinforcement in the concrete and waste containers, but degradation of organic material and radiolysis also contribute (see Section 6.3.7).

Bentonite is known to have relatively high transport resistance in general and for gas in particular. Besides the evacuation pipes, the silo in SFR is planned to be completely embedded in bentonite and sand/bentonite mixtures. If the evacuation pipes are functional, there is no reason to assume that any significant gas pressure will form inside the silo.

As concluded from a relatively large set of tests of gas migration on bentonite and montmorillonite (Birgersson and Karnland 2014), the general picture is that diffusion is the only mass transfer mechanism for gas when the gas pressure is lower than the pressure in the bentonite. When the gas pressure exceeds the bentonite pressure, on the other hand, mechanical interaction between the two phases is inevitable. The mechanical interaction may manifest as gas breakthrough events, or possibly as a consolidation of the clay phase (with only diffusive transfer in the bentonite).

Under conditions where the gas pressure exceeds the bentonite pressure, it has been demonstrated that mechanical interaction between the gas phase and the bentonite will inevitably occur (Karnland and Birgersson 2014). Furthermore, when such interactions occur the gas has been demonstrated to primarily follow flow paths in the interfaces between bentonite and other materials. A probable scenario is, therefore, that the gas will be propagated to the bottom of the silo, where it will escape through the bentonite/sand mixture. Since this mixture contains 90% sand, it will reasonably contain bentonite/sand interfaces on the pore scale to such an extent that gas may escape there in a controlled manner.

### **Concrete barriers**

Concrete consists of hydrated cement clinker minerals mixed with various filling and aggregate materials such as sand and gravel. A majority of the concrete structures also contain reinforcing bars. In some structures form rods are embedded in the concrete, which has been used during construction.

Transport of radionuclides mainly occurs in the water phase through fractures and the concrete pore structure. Since concrete has a high specific surface area that provides sorption capacity, the mobility of radionuclides is limited by sorption.

The most important processes that can affect the function of the concrete barriers are:

- Widening of existing fractures, which gives rise to an increased and more localized water flow.
- Formation of new fractures and fracture networks that could increase the hydraulic conductivity in the barrier and, depending on network structure, create a more localized flow.
- Loss of cement minerals which will alter the composition and transport properties of the cement and pore water.
- Clogging of fractures by precipitation of mineral phases, for example calcite.

This section begins with a general description of the concrete barriers followed by a description of the processes that are judged to be most important for the long-term function of the concrete barriers. Furthermore, the section gives a description of the evolution of the concrete barriers based on the processes likely to affect the concrete barriers in the waste vaults (1BMA, 2BMA and 1BTF, 2BTF and the silo) during the first 1,000 years after closure.

### **General description of the concrete barriers**

The composition of the hydrated cement minerals in the concrete, resulting from the initial hardening of the concrete, has been calculated and is presented in Table 6-7. The main binding phases of hydrated cement is calcium silicate hydrates (CSH) and portlandite ( $\text{Ca}(\text{OH})_2$ ).

The concrete barriers will initially have a total porosity of about 10%. The pore structure consists of connected and unconnected pores, see pore structure A in Figure 6-13. The connected pores influence the transport properties of the concrete such as its hydraulic conductivity and diffusivity. The concrete structures will also contain some fractures caused by volume changes such as shrinkage during hydration of the cement paste, changes in humidity and temperature during operation and water saturation after repository closure, see fracture C in Figure 6-13.

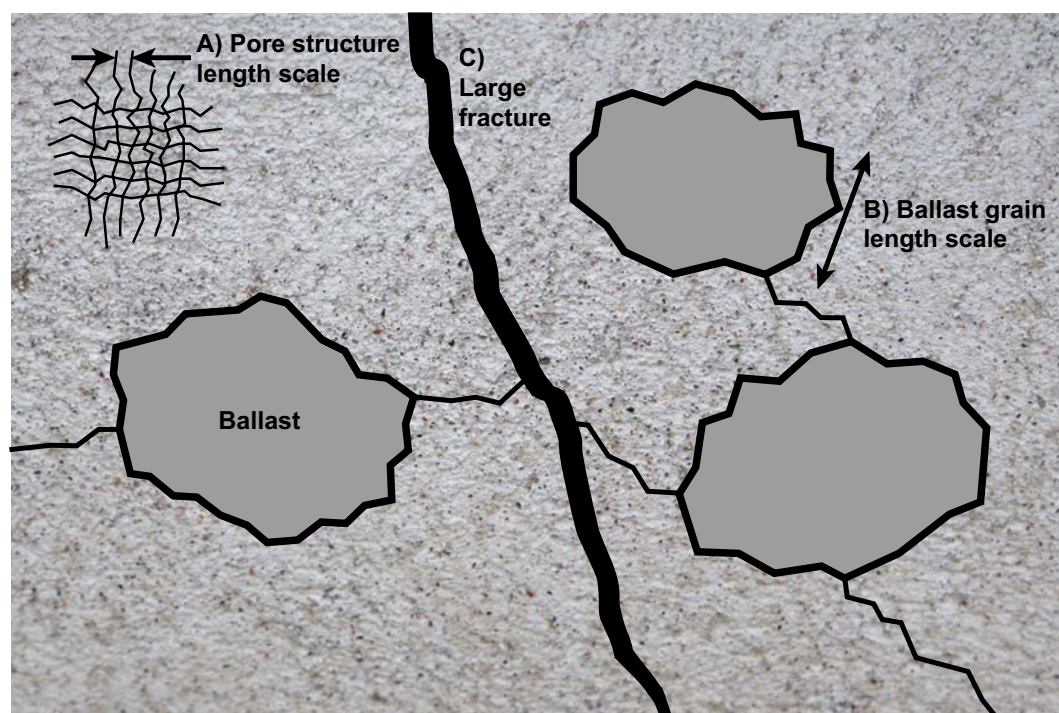
New fracture networks may be formed as a result of a number of different processes, the most important of which are discussed in this section. The aperture of the largest penetrating fracture is a critical parameter, since the hydraulic conductivity of a fracture network increases with the cube of the fracture aperture (Höglund 2014). The average pore size or fracture aperture in a fracture network is determined by the number of fractures between which the volume of the network is distributed. For a fracture network with high fracture density, the average fracture aperture is small, since the volume of the fracture network is distributed over a large number of fractures. The average distance between pores or fractures in a fracture network defines the extent of the pore or fracture network, see Figure 6-13.

For the BMA vaults, the water flow through the waste is determined by the hydraulic contrast, i.e. the ratio between the hydraulic conductivity of the concrete barrier and the backfill material. This contrast can be estimated using the Kozeny–Carman equation for the backfill material and barrier (Neretnieks and Moreno 2013, Höglund 2014), see Figure 6-14. The Kozeny–Carman equation relates the hydraulic conductivity of a porous or fractured material to the porosity of the material (Bear 1988). It also includes a factor that depends on the average particle size or the average inter-fracture distance.

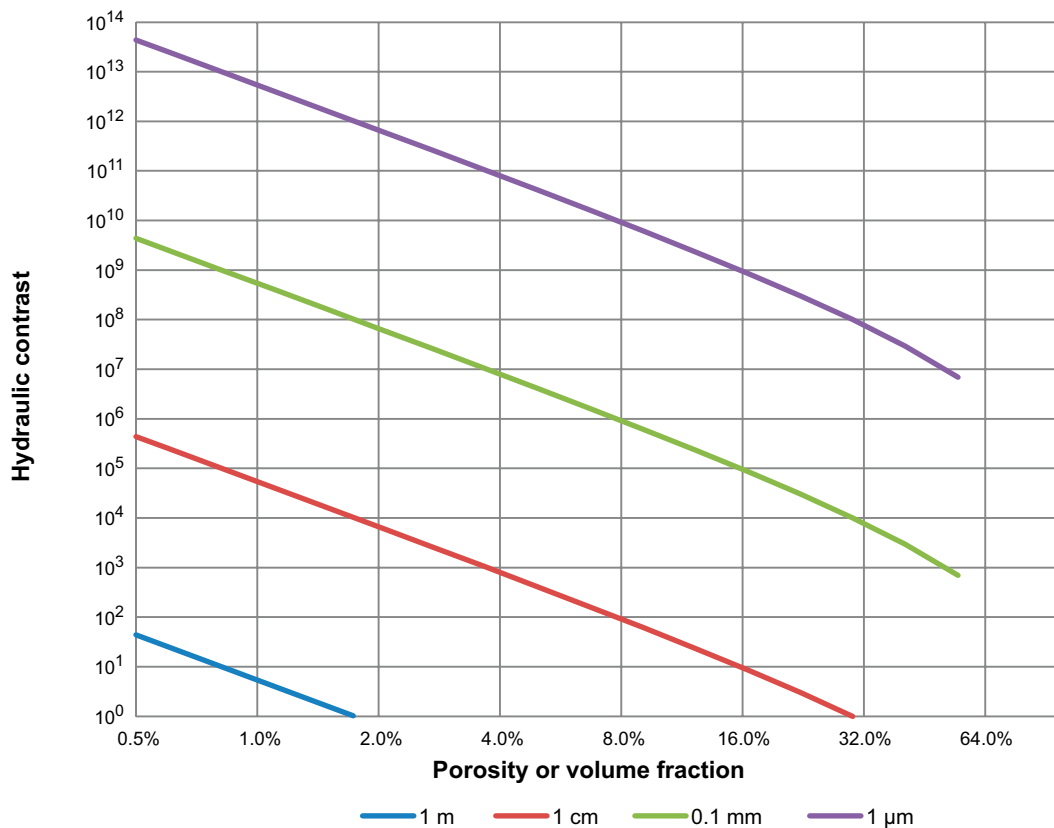
Initially, fractures up to a width of 0.1 mm may occur in the concrete structures in BMA (**Initial state report**).

**Table 6-7. Composition of hydrated cement used in SFR (Höglund 2014).**

Hydrate	Amount kmol/m <sup>3</sup> concrete	Fictive concentration kmol/m <sup>3</sup> pore water
C <sub>3</sub> FH <sub>6</sub>	0.1008	1.020
C <sub>3</sub> AH <sub>6</sub>	0.02397	0.2424
Monosulphate	0.09613	0.9722
Ettringite	0	0
CSH-gel (Ca/Si=1.8)	1.225	12.39
Portlandite	1.036	10.48
Brucite	0.06079	0.6149
KOH	0.04607	0.4660
NaOH	0.007903	0.07993
CaCO <sub>3</sub>	0.06295	0.6367
Porosity	0.099 m <sup>3</sup> /m <sup>3</sup> concrete	



**Figure 6-13.** Fractures in concrete, A) Pore structure in micrometre scale formed during hardening of the cement paste. B) Fractures in cement/aggregate interface on millimetre to centimetre scale. C) Fractures due to other processes such as shrinkage or external forces, centimetre to metre scale.



**Figure 6-14.** Hydraulic contrast between barrier and backfill material as a function of the barrier's porosity for fracture networks with inter-fracture distances of 1 m, 1 cm, 0.1 mm and 1 μm. The backfill is assumed to have a grain size of 1 cm and 30% porosity.

### Leaching of concrete

With time, the transport properties of the concrete will change due to a number of chemical processes. Interaction between concrete and groundwater first leads to the highly soluble alkali hydroxides leaching from the cement paste. This is followed by  $\text{Ca}(\text{OH})_2$  (portlandite), which is an important constituent in the cement paste in the concrete, starting to dissolve and leach. Finally, when the portlandite has been leached out, an incongruent dissolution of calcium silicate hydrates (CSH) begins. Dissolution of CSH is an incongruent dissolution of a solid solution usually represented by a set of equilibrium phases  $\text{CSH}_X$ , where X is the ratio of  $\text{Ca}^{2+}$  to  $\text{Si}_x\text{O}_y$ . The leaching process leads to a gradual decrease of pH in the concrete pore water. A more complete description is given in Höglund (2014) and in Section 6.4.8 (Degradation of concrete).

### Chemical interactions with groundwater and substances leached from the waste

Substances dissolved in the groundwater, such as  $\text{SO}_4^{2-}$ ,  $\text{HCO}_3^-$  and  $\text{Cl}^-$ , will react with minerals in the cement, giving rise to precipitation of secondary phases (Höglund 2001, 2014, Gaucher et al. 2005, Cronstrand 2007, 2014). In addition, the exposure to increased concentrations of solutes released from the waste may give rise to dissolution–precipitation. Important dissolution and precipitation processes include: The formation of ettringite from monosulphate after increased sulphate exposure, the formation of Friedel's salt as a result of increased  $\text{Cl}^-$  concentrations; or precipitation of thaumasite as a result of increased exposure to  $\text{CO}_2/\text{CO}_3^{2-}$  (aq) and  $\text{SO}_4^{2-}$ .

### **Fracturing due to pressure from the waste**

As the waste domain becomes saturated with water, a number of processes will start that could exert a pressure on the barriers, such as corrosion of metallic waste and gas production, see Section 6.3.7.

In order for the gas formed in waste packages and concrete structures in the repository to escape, passages for gas transport must be formed in the barriers. Gas transport and the quantity of water expelled from the silo and rock vaults are determined by the design of the barriers and the properties of the barrier materials. In materials with a fine pore structure, such as concrete, capillary forces are important for the pressure build-up that is needed to expel gas. Water will be expelled from the concrete until a network of empty pores for transport of gas has been formed. When passages for gas transport have been formed in the barrier, gas will escape as long as the pressure difference exceeds the capillary pressure. When the pressure drops below the breakthrough threshold, the pores will be resaturated until a sufficiently high pressure has built up to once again form a transport path. In concrete waste packages and concrete structures, a number of small fractures are sufficient to expel all the gas. If the available transport paths are not enough to expel the formed gas sufficiently, additional fracturing in the barriers may occur.

Pressure on the barriers may also be caused by for example swelling ion exchange resins or by corrosion products formed by metal corrosion congregating around the original metal components and exerting there an internal pressure.

In 1BMA and 2BMA this is handled by grouting of waste compartments in such a way that there is adequate void volume to prevent potentially swelling waste from exerting excessive pressure on the surrounding barriers.

In the silo this is handled by the bitumen-solidified ion exchange resins being deposited in some of the most central shafts. A study concerning these effects shows that even though the swelling pressure may cause damages in the interior of the silo by crushing the grout and causing fracturing in the shaft walls, the outer walls will not be affected (von Schenck and Bultmark 2014).

Finally, the concrete tanks in BTF contain sufficiently large void volume to prevent the pressure from potentially swelling waste causing damage to the walls of the tanks.

### **Corrosion of reinforcement and other steel components**

Initially, reinforcing bars and other steel components embedded in the concrete structures such as form rods from casting are passivated by the high pH of the concrete. With time, intrusion of  $\text{Cl}^-$  and  $\text{CO}_3^{2-}$ , in combination with groundwater leaching of alkaline components, can depassivate the steel surfaces so that corrosion is initiated. Although chloride intrusion is delayed by the formation of chloride containing minerals, for example Friedel's salt, depassivation cannot be ruled out after Friedel's salt has formed (Höglund 2014). As a result of the corrosion processes, a layer of corrosion products will form on the metal surface. These corrosion products will mainly consist of  $\text{Fe}_x\text{O}_y$  and  $\text{Fe}(\text{OH})_x$ . As the molar volume of the corrosion products is larger than the volume of the iron, a gradual volume expansion will occur in the interface between concrete and metal with mechanical stress in the concrete surrounding the reinforcing bars as a result. If the stress exceeds the concrete tensile strength fractures will form in the concrete (Höglund 2014). If the corrosion process is allowed to progress, the continued accumulation of corrosion products will lead to an increasing fracture width and ultimately to spalling of the concrete cover. For penetrating steel components such as form rods, corrosion can cause fractures that penetrate the barrier rather than spalling of the cover. If the corrosion products are instead dissolved in the water and transported away from the source, a void will form in the space that previously contained the corroding material.

In order to avoid the negative effects of reinforcement corrosion and corrosion of form rods, the concrete caissons in 2BMA will be designed without reinforcement and the casting process will be completed in such a way that the use of form rods can be avoided. The measures that will be adopted to avoid corrosion of form rods causing penetrating fractures or channels in 1BMA are described in the Closure plan for SFR (SKBdoc 1358612).

The concrete tanks in BTF contain various metal components embedded in the concrete walls. Some fracturing may occur near the metal components during the first 1,000 years after closure.



Chloride intrusion in the silo will probably be low, but it cannot be excluded that the chloride concentration towards the end of the time period in question will be higher than the threshold at which corrosion may be initiated in the outer parts of the silo walls.

### **Intrusion of chemicals dissolved in the groundwater and solutes from the waste**

After closure, the concrete barriers will become saturated by groundwater. Solutes will start to diffuse into the concrete structure and lead to the formation of secondary minerals, primarily in the outer parts of the structure. Some secondary minerals, for example ettringite, have the ability to bind large quantities of water as water of crystallisation, which means that this mineral has large potential for expansion when absorbing water. If insufficient pore volume is available for mineral expansion, this process could lead to fracturing and mechanical degradation of the concrete (Höglund 2014). During the first 1,000 years, ettringite will form in a thin layer on the outer parts of the concrete barriers (Höglund 2014).

Some waste forms in 1BMA contain significant quantities of soluble salts. For some waste compartments, this will mean that the formation of new minerals will occur at a higher rate in the concrete and cement in the waste, compared with the parts of the concrete barriers exposed to groundwater.

The main sulphate inventory in 1BMA stems from evaporator concentrates and the quantity of ettringite that can be formed inside waste compartments is limited by the amount of  $\text{SO}_4^{2-}$  that can be released from the waste. Waste compartments in 1BMA containing evaporator concentrates also contain a sufficient quantity of cement for the largest fraction of  $\text{SO}_4^{2-}$  released from evaporator concentrates to form ettringite within the waste domain and/or grout, see Table 6-2. Some local impact by the concrete barrier itself cannot, however, be fully excluded.

During the first 1,000 years after closure, small amounts of ettringite may form in the concrete barriers close to sulphate containing waste.

### **Local concrete degradation**

After closure and resaturation of the waste vaults, the groundwater and solutes in the groundwater will react with cement minerals. The processes that occur in connection with fractures and other local weaknesses are the same as generally apply for degradation of concrete in this type of environment and are not repeated here. In studies of local concrete degradation, water is assumed to flow only in the fracture, while diffusion is the dominant transport mechanism in the concrete between fractures.

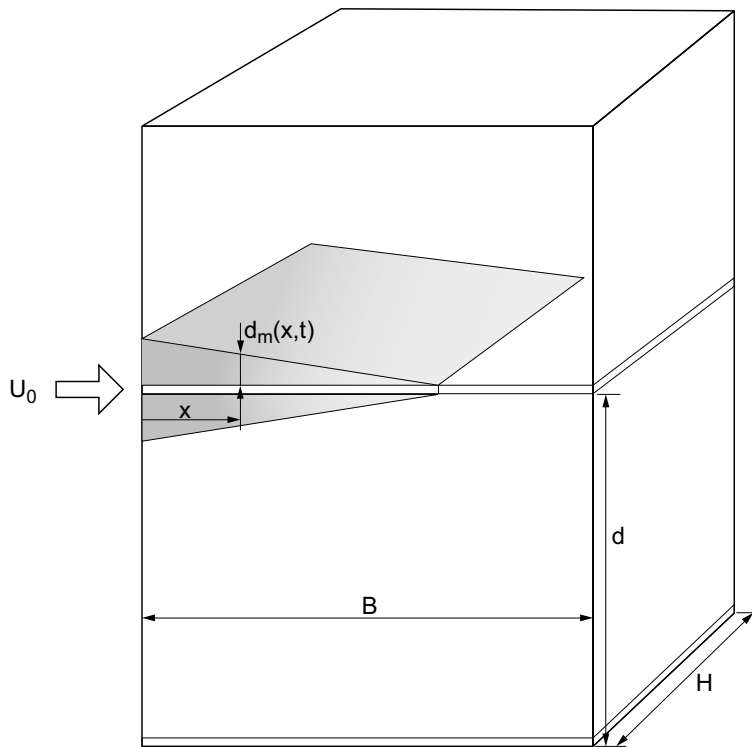
The effect of local leaching processes is the formation of a portlandite-depleted zone in connection with for example a fracture, through which a certain amount of water flows. This zone will be developed both along the length of the fracture but also in a direction essentially perpendicular to the extent of the fracture, see Figure 6-15, which will lead to a wedge-shaped dissolution front propagating through the concrete barrier (Höglund 2014). The portlandite-depleted zone may have a higher porosity and could be more permeable to water than intact concrete.

When the portlandite-depleted zone has extended along the whole length of the fracture, water which is unsaturated with respect to portlandite will start to flow in through the concrete wall.

The hydraulic properties of a fracture are not expected to change until the portlandite-depleted zone has penetrated the entire fracture, i.e. corresponding to the whole thickness of the concrete barrier. For 1BMA and 2BMA, where the fractures in the concrete barrier have apertures less than 0.1 mm, the water flow rate in the fractures is sufficiently low to ensure that this will not occur during the first 20,000 years after closure (Höglund 2014).

A thin layer of portlandite-depleted concrete will also form along with the surface of the concrete barriers due to portlandite dissolution. The formation of such a layer with higher porosity at the barrier surface will not affect the barrier's hydraulic properties during the first 1,000 years after closure.

For the concrete tanks in BTF, the local degradation due to portlandite leaching in fractures is not considered to cause any significant changes in the hydraulic properties of the tanks during the first 1,000 years.



**Figure 6-15.** Wedge-shaped portlandite-depleted zone formed at a barrier-penetrating fracture.

The water that enters the fractures will contain several solutes that can form secondary minerals. This may lead to closure of fractures or the formation of secondary minerals in the concrete close to the fracture. The positive effects of these processes are not, however, considered in the safety assessment.

### **Backfill material**

At closure, the voids outside the concrete barriers in 1BMA and 2BMA will be backfilled with macadam, i.e. crushed rock with no or very small amounts of fine-grained material. Depending on the chosen quality of the backfill material, there may be differences in sensitivity to chemical interaction with the concrete barriers and the groundwater/surrounding rock. Assuming that the backfill material will be similar to the aggregate used for the concrete, which consists of Baskarp sand and is essentially pure quartz with low contents of reactive silica, a detrimental reaction with the alkaline pore water in the concrete barrier is unlikely.

Although the backfill material may be resistant to chemical interactions with the concrete pore water, at least in a short-term perspective, the backfill may constitute a mixing point between the leachate from the concrete barrier and the surrounding groundwater, see Section 6.3.6.

Radionuclides and ions dissolved in water transported through the backfill can be sorbed to the material.

In gravel obtained from (freshly) crushed crystalline rock, the principal (primary or rock-forming) minerals which provide surfaces for sorption are typically micas. In comparison, other important primary minerals in typical crystalline rock (quartz and feldspars) have a considerably smaller specific surface area and/or lower concentration of relevant surface sites per unit mass. The importance of micas, and in particular biotite that contains large amounts of structural Fe(II), has been confirmed experimentally for sorption of various radionuclides on fresh granitic rock and weathered fracture surfaces, e.g. Kienzler et al. (2009) and Koskinen et al. (1988). In substantially altered or weathered material, clays, iron (hydr)oxides and other filling minerals may become more significant. Generalisations regarding the sorption properties of such materials are difficult to make, since they may depend to a high degree on the specific alteration or weathering history.

In the case where the backfill consists of sand/macadam (see Section 4.3), it may be assumed that mineralogy is dominated by quartz. Quartz surfaces in contact with water have SiOH-groups that can bind solutes through surface complexation/ligand exchange because of their acidic character (Stumm and Morgan 1996), which makes retention of radionuclides possible in the backfill.

### Transport of solutes

What happens to the dissolved  $\text{CO}_3^{2-}$  and  $\text{Ca}^{2+}$  present in the groundwater when it interacts with concrete environments with high pH will be determined by precipitation and dissolution of calcite or more complex mineral phases. Furthermore, supply of  $\text{SO}_4^{2-}$  and  $\text{Cl}^-$  may affect the concrete structure.

Concentrations of  $\text{K}^+$  and  $\text{OH}^-$  are much higher in the cement pore water than in the groundwater, which generates a diffusion gradient. Hydroxide penetration will increase the pore water pH.

## 6.4 Periods of temperate climate domain more than 1,000 years after closure

The temperate climate domain is defined as regions without permafrost or the presence of ice sheets (**Climate report** Section 1.3.2). In a broad sense the area is dominated by a temperate Baltic Sea coast climate, with cold winters and either cold or warm summers. It includes period of different degrees of global warming and also periods of submerged conditions. According to the reference climate cases (see Section 6.2), temperate conditions will prevail in Forsmark at least until circa 52,000 AD. The only exception is the relatively short period of periglacial climate between 17,500 AD and 20,500 AD in the *early periglacial climate case*.

The influence of the shoreline regression on the evolution of the repository system will become less and less important as the shoreline becomes located further away from the repository.

The description of the repository evolution during periods of temperate climate domain more than 1,000 years after closure exhibits continuity with what has been described in Section 6.3. The following description is thus a continuation of the preceding section and the backgrounds to the various topics are not repeated here.

### 6.4.1 Evolution of surface systems

The presentation of the development of the surface systems during periods of temperate climate domain more than 1,000 years after closure has been divided into two time periods:

- The period from 3000 AD to 12,000 AD.
- The remaining part of the assessment period.

At about 12,000AD, succession has turned all lakes that may receive radionuclides originating from the repository (so called “biosphere objects” in Appendix H, see also the **Biosphere synthesis report**) into terrestrial areas (wetlands, forests or agricultural land). It is also consistent with the time when geohydrological water flows have come to steady state and thereby is the latest time step studied in the hydrological analyses producing exit points for the biosphere modelling and water flows used in radionuclide transport and dose calculations (Odén et al. 2014, Werner et al. 2014). Furthermore, this is also the approximate time when the sea disappears from the model area (see Figure 6-16 and Figure 6-17), which implies a transition from landscape development affected by both shoreline evolution and climate change to development affected by climate only.

Note that whereas a similar subdivision of the assessment period was considered also in earlier safety assessments e.g. SAR-08 and SR-Site (SKB 2008a, 2011), the motivation for it is somewhat different in the present assessment. Specifically, in earlier assessments the 10,000-year time frame was relevant because it marked the initiation of a colder climate with permafrost in the *Weichselian glacial cycle climate case* then considered as the “climate base case” in the main safety assessment

scenario. This differs from the various global warming-based climate cases considered in the present safety assessment, where the first occurrence of periglacial climate comes later (even in the *early periglacial climate case*).

As discussed in Lindborg (2010), the **Biosphere synthesis report** and illustrated below, human land-use is another factor that could have a large impact on landscape development. As discussed in Section 6.2, the different climate scenarios will have different effects on the shoreline evolution due to increased sea levels in the *extended global warming case* as compared with the *global warming climate case*. Below, focus is on the description of the global warming case which is the base case, but also the effects of extended global warming are visualised.

The modelled landscape development described below should be seen as an example of a possible future. The uncertainties in the description of landscape development are essentially the same for all three parts of the assessment period (first 1,000 years, 3000–12,000 AD and 12,000–100,000 AD), and also the same as in the earlier SR-Site safety assessment (SKB 2011). The present description is judged to be associated with the following three major uncertainties:

- The configuration of the landscape, e.g. location and size of future lakes and streams, and depth and stratigraphy of regolith layers.
- The timing of different events, e.g. withdrawal of the sea, and isolation and infilling of lakes.
- The composition and properties of species and communities inhabiting the future landscape.

Uncertainties in the development of the landscape configuration in Forsmark are not handled explicitly in the modelling. Thus, the modelled landscape development should be seen as an example of a possible future, based on a thorough understanding of present-day geometries and an expected shoreline evolution. The topography is not expected to vary significantly during the period, and the main uncertainties in the future landscape configuration are associated with the locations of the thresholds that determine where future lakes are formed in the landscape. However, since previous safety assessments, additional site data have been gathered and new digital elevation and landscape development models have been produced (Strömngren and Brydsten 2013, **Biosphere synthesis report**), resulting in a higher confidence in the thresholds of the future lakes of interest for the present safety assessment.

In the safety assessment, low-lying areas that potentially will be affected by discharge of groundwater from the SFR repository are identified and fully described over time. From the primary release location in the biosphere, to a so called biosphere object, radionuclides can be transported to downstream biosphere objects (See Chapter 8). Each biosphere object included in this analysis will go through a succession, either from being part of the open sea, over a sea bay phase, to a wetland phase and possibly further to agricultural land, or from open sea to sea bay to a lake that with time eventually transforms to a wetland and possibly agricultural land. In the calculation case of extended global warming, effects of alternative timing of the withdrawal of the sea are evaluated. The biosphere objects also encompass variation, both in size and in the timing and rate of succession of events, which means that a range of conditions are covered in the analysis.

Uncertainties associated with the depth and development of regolith layers, the infilling of lakes, the future surface hydrology and the properties of species and communities that may inhabit the future landscape, are handled either as parameter uncertainties or in systematic studies of alternative scenarios in the modelling of radionuclide transport and accumulation in the surface system. Natural variations of biomass and primary productivity in temperate aquatic and wetland ecosystems similar to those observed in Forsmark today, or expected to develop in the area, have been used to characterise uncertainties in the properties of plant or animal communities that may inhabit the future landscape.

### ***The period from 3000 AD to 12,000 AD***

During this period, the regressive shoreline displacement is assumed to continue, but at a gradually declining rate (**Biosphere synthesis report**, see also Section 6.2). Initially, the shoreline will be subject to a horizontal transfer of approximately 1 km per 1,000 years. This will strongly influence the landscape, especially during the first part of the period, and it will result in a situation where the SFR repository has an inland rather than a coastal setting (see Figure 6-16). The strait at Öregrund, south

of the modelled area, is expected to be cut off about 3000 AD, and Öregrundsgrepen will turn into a bay. This will affect the water circulation, and, due to the continued narrowing of the bay, the water turnover will be further restricted.

During the period from 3000 to 5000 AD, an archipelago is expected to develop east of the repository. Around 5000 AD, many straits in this archipelago will close and a number of lakes will be isolated from the sea. At 5000 AD, the shoreline has withdrawn circa 5 km from the SFR repository. A network of streams connecting the new lakes develops in the new terrestrial areas. These streams are small, but streams dewatering parts of the area will join a larger stream in the south-east at about 5000 AD. This large stream consists of the merged Forsmarksån and Olandsån, draining a large part of Northern Uppland.

During the period from 3000 AD to 12,000 AD, the Öregrundsgrepen bay gradually shrinks to form a narrow bay along Gräsö Island, which at 12,000 AD has become a set of lakes; at this time, the sea has left the model area (Figure 6-16). A large number of lakes will be isolated from the sea during the period. Most of the new lakes are small and shallow, and are expected to be infilled and transformed into mires within a period of 2,000 to 6,000 years (Brydsten and Strömgren 2010, **Biosphere synthesis report**). As shown in Figure 6-16, almost all lakes in the area have been infilled and only some initially relatively large and deep lakes near Gräsö Island are expected to remain at 12,000 AD.

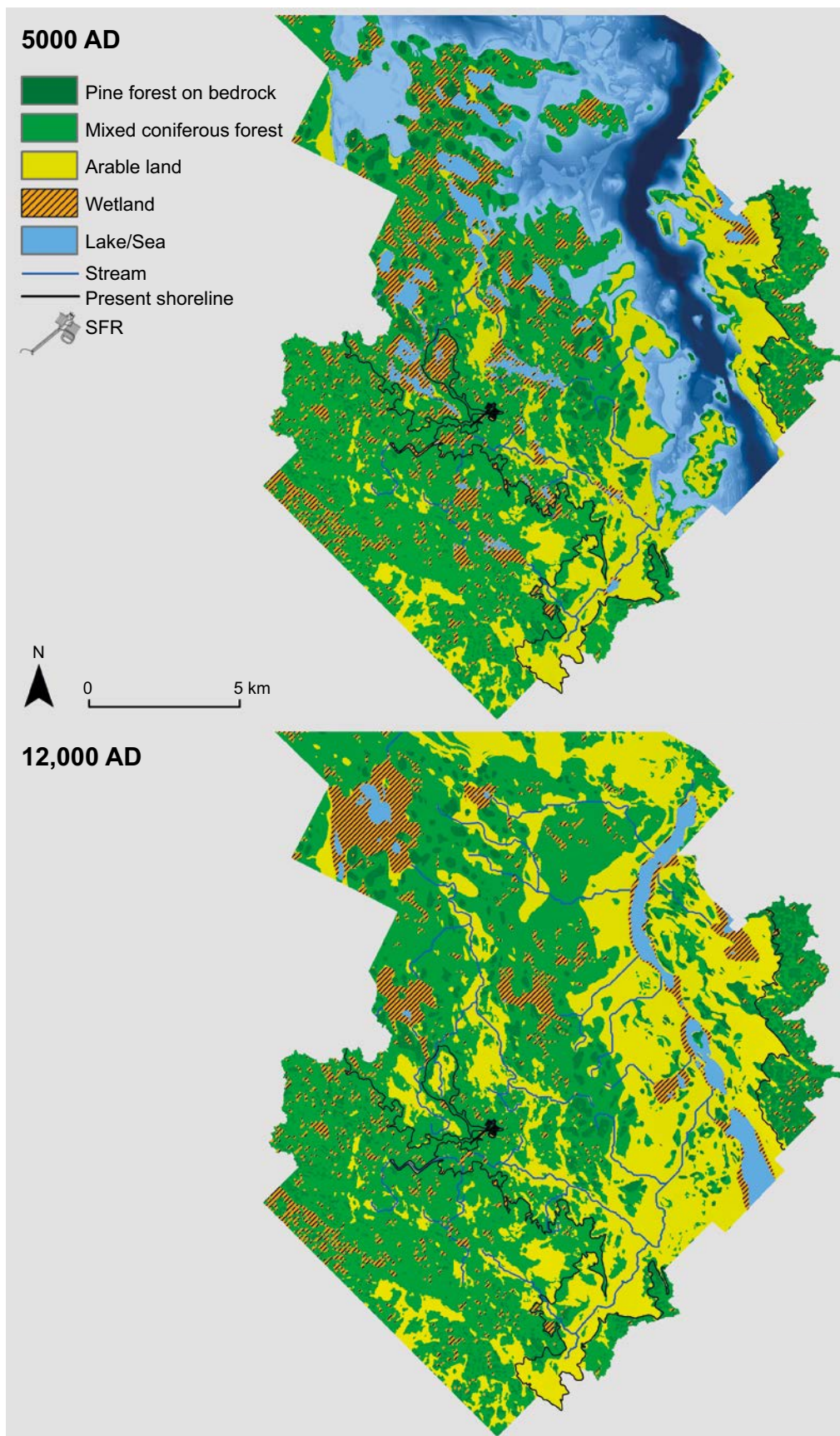
Around 6000 AD, the salinity in the marine basins is expected to have decreased to 3–4‰, which means that an ecosystem similar to that in the Northern Kvarn today, with lower abundance of marine species and higher of freshwater species, will develop. According to Brydsten (2009), accumulation of sediments may occur both on bottoms at greater water depths and on shallow bottoms that are sheltered from wave exposure inside a belt of the skerries. Erosion occurs mainly on shallow bottoms exposed to waves. Transport bottoms can be found in all places between these two extremes, i.e. at intermediate depth with moderate wave exposure.

When new areas of the present seafloor are raised above sea level, weathering of the lime-rich regolith is initiated. Most of the easily weathered calcite in the upper regolith will be dissolved and washed out within a period of some thousands of years (Tröjbom and Grolander 2010). This means that the strong influence of the calcium-rich deposits on the terrestrial and limnic ecosystems will be reduced over time. For instance, the oligotrophic hardwater lakes that are characteristic of the coastal area in Forsmark will likely be transformed to more dystrophic (low pH, brown-water) conditions within some thousands of years after isolation from the sea (see Andersson 2010).

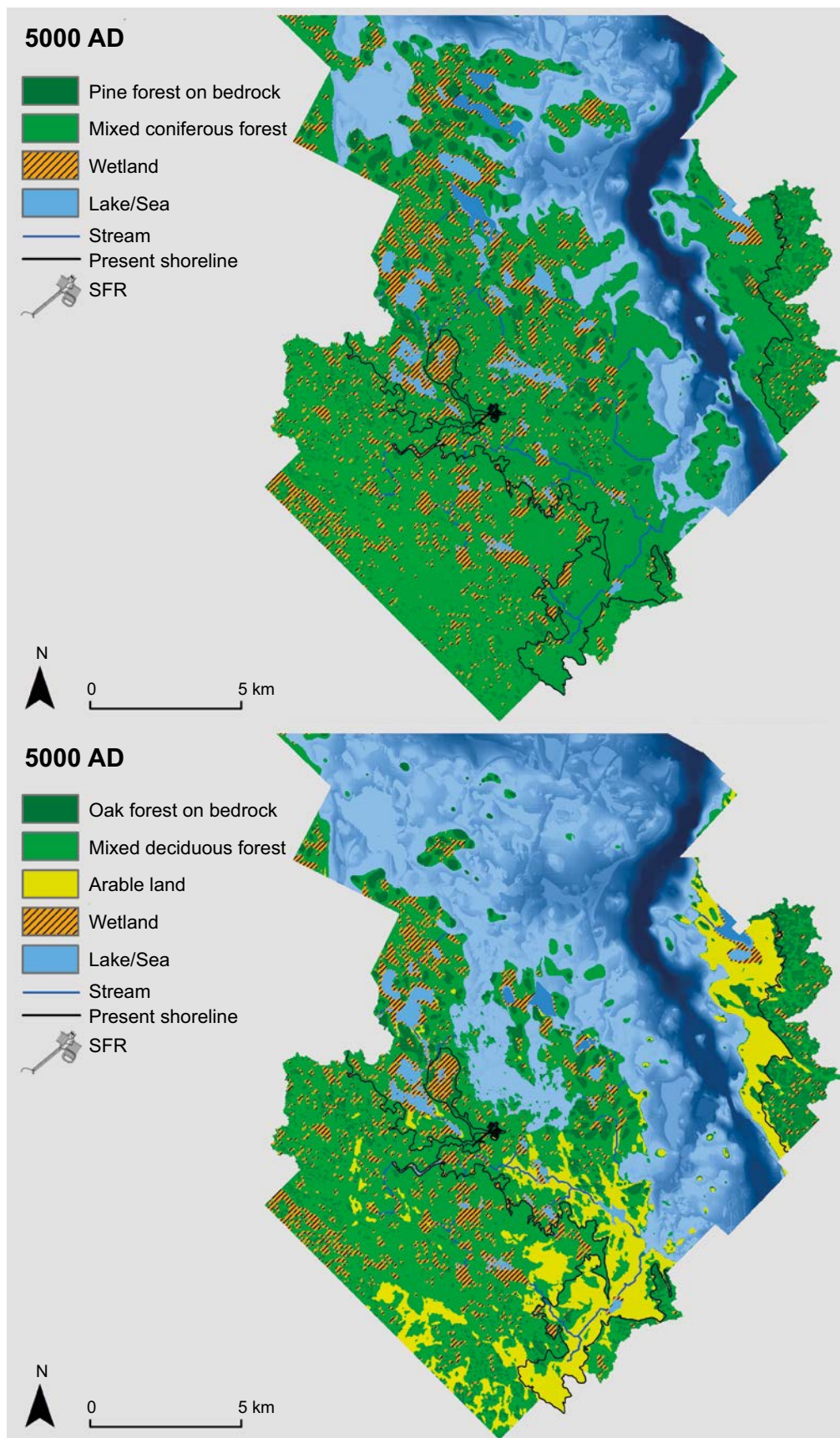
Much of the newly formed land will be unsuitable for farming due to boulder- and stone-rich deposits (see Lindborg 2010), but there are large areas in central Öregrundsgrepen with fine-grained sediments that can be cultivated (as indicated by the yellow areas in Figure 6-16). Also patches of organic soils on previous lakes/mires may be cultivated, but presumably these soils can be sustainably utilised only for limited periods, since compression and oxidation of the organic material will lower the ground surface and cause problems with drainage (see Lindborg 2010).

The food productivity in agricultural areas is several hundred times higher than that in aquatic or non-cultivated terrestrial areas (Andersson 2010, Aquilonius 2010, Löfgren 2010). This means that the potential food productivity in the total modelled area is expected to increase during the period. The availability of freshwater for human supply is expected to gradually increase. New groundwater, potentially useful as drinking water, will be available when the shoreline moves eastwards. Among already existing geological formations, the Börstilåsen esker may provide groundwater of drinking-water quality.

As discussed above, climate variations and shoreline evolution are major factors affecting landscape development, which, however, also is influenced by the human utilisation of the landscape. In the landscape development modelling, the effects of these factors are studied by formulating a set of landscape development variants based on different assumptions regarding climate, land-use and related processes. Figure 6-17 shows two examples of the results for 5000 AD illustrating different variants, which can be compared with each other and with the top map in Figure 6-16. A detailed presentation of the modelling, including the assumptions associated with the variants, is provided in the **Biosphere synthesis report**.



**Figure 6-16.** Modelled distributions of vegetation and land-use in Forsmark at 5000 AD and at 12,000 AD for the global warming climate case. All areas that potentially can be cultivated are represented on the map as arable land; see the **Biosphere synthesis report** for details on the landscape development modelling. The present shoreline is marked as a black line and darker shades of blue represent deeper sea.



*Figure 6-17. Modelled distributions of vegetation and land-use in Forsmark at 5000 AD for two landscape development variants, resulting from the global warming climate case assuming a landscape unaffected by humans (top) and from the extended global warming case assuming a land-use similar to that today (bottom); see the **Biosphere synthesis report** for details on the landscape development modelling and the assumptions underlying the different variants. The present shoreline is marked as a black line and darker shades of blue represent deeper sea.*

The top map in Figure 6-17 shows a landscape unaffected by humans, the most obvious difference compared to that in Figure 6-16 being the absence of arable land. The bottom map in Figure 6-17 shows results for modelling based on the extended global warming climate case. This climate case implies larger effects of human activities on the climate than the other climate cases that involve global warming, which leads to different underlying assumptions for the landscape development modelling. As indicated by the comparison between the extended global warming case results in Figure 6-17 and the 5000 AD global warming results in Figure 6-16, these differences in assumptions concern both the shoreline evolution and the future vegetation. In particular, the extended global warming case is based on a 1,000-year delay of shoreline evolution, which results in a larger area of sea at 5000 AD, and has some differences in the types of vegetation, with oak and deciduous forest replacing pine and mixed coniferous forest, respectively.

### ***The remaining part of the assessment period***

In the global warming climate case, the temperate climate domain prevails during 69% of the assessment period, whereas the corresponding fraction is 66% for the early periglacial case which includes an additional 3,000-year period of periglacial domain (**Climate report**). The extended global warming climate case assumes that the onset of a colder climate is delayed, which implies that the whole 100,000-year period is characterised as belonging to the temperate domain. For the global warming and early periglacial cases, the second half of the assessment period is projected to consist of alternating periods of temperate and periglacial climates (Section 6.2).

During future periods of temperate conditions, Forsmark is assumed to show biosphere characteristics similar to those of the later parts of the initial 10,000 years of the temperate period, i.e. the landscape will consist of terrestrial ecosystems, mainly forests and mires, with few or no lakes and no sea. Parts of the area, especially those with fine-grained sediments in central Öregrundsgrepen (see Figure 6-16), can potentially be used for long-term agriculture (see the **Biosphere synthesis report**). Patches with mainly organic soils may also be cultivated for limited periods. Higher altitude areas with outcrops of bedrock will be forested with pine. Also, the pattern for discharge of deep groundwater and the conditions determining transport and accumulation of radionuclides in the landscape are expected to be similar to those prevailing during the latter part of the initial temperate period (Odén et al. 2014).

Figure 6-18 shows an example of a modelled landscape representing 40,000 AD, which is the last time step considered in the landscape development modelling. It can be seen that succession has turned the lakes into terrestrial areas, including the deeper sea bay/lakes adjacent to the present Gräsö Island (Figure 6-16). These areas are for the most part marked as arable land in Figure 6-18, which to some extent is a consequence of the fact that the figure displays results for a model variant where all land that can be cultivated is assumed to be used as arable land.

## **6.4.2 Thermal evolution**

See Section 6.3.2.

## **6.4.3 Mechanical evolution**

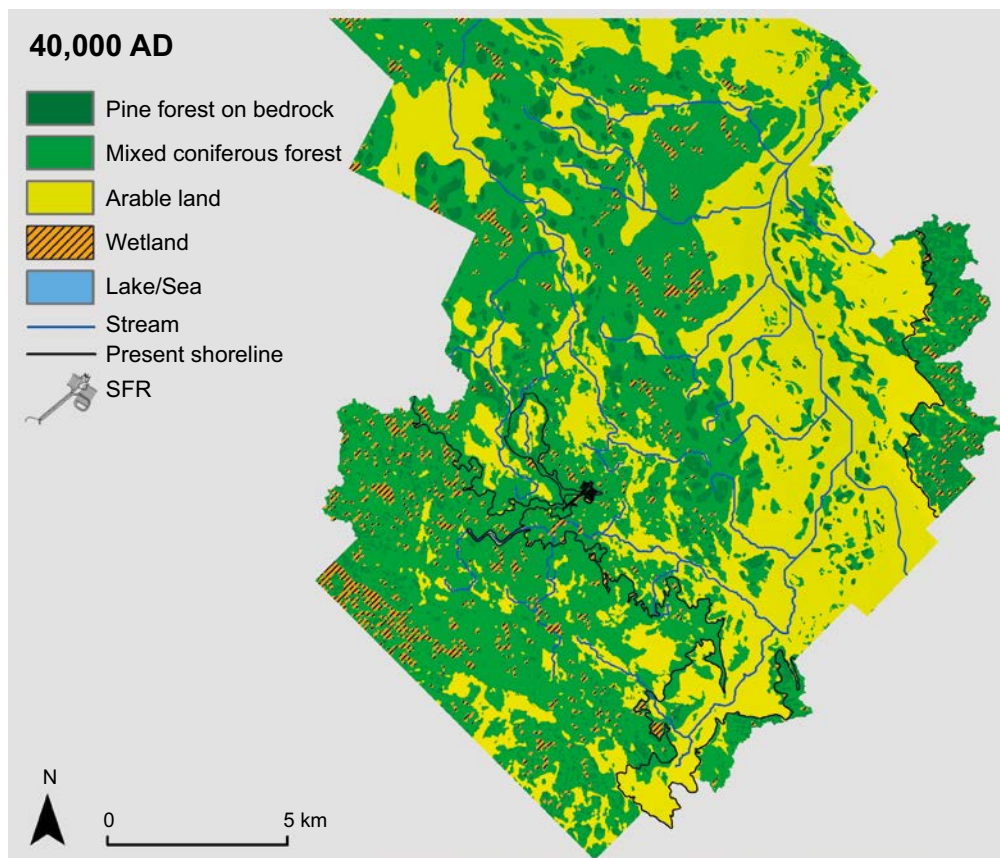
See Section 6.3.3.

## **6.4.4 Hydrogeological evolution**

### ***Terrestrial conditions***

When the shoreline is far away from the repository, the effect of the shoreline as the main discharge area for discharging groundwater flow becomes negligible. Terrestrial conditions with almost steady-state flow are assumed from about 5000 AD and the situation at 9000 AD can be assumed to represent all future temperate climate domains in the assessment period (Odén et al. 2014). Almost every particle from SFR 1 exits in a depression in the topography close to where ZFMNNE0869 and ZFMNW0805A outcrop, see Figure 6-19. During the early stages, SFR 3 has exit locations both north and south of the SFR pier. As the horizontal component in the flow regime successively grows, the exit locations are driven north towards the same depression in the topography as where the particles from SFR 1 exit. However, owing to its deeper location, a small number of particles from SFR 3 discharge into lakes and streams further away from the repository, see Figure 6-19.





**Figure 6-18.** Modelled distribution of vegetation and land-use in Forsmark at 40,000 AD for the global warming climate case. All areas that potentially can be cultivated are represented on the map as arable land; see the *Biosphere synthesis report* for details on the landscape development modelling. The present shoreline is marked as a black line.

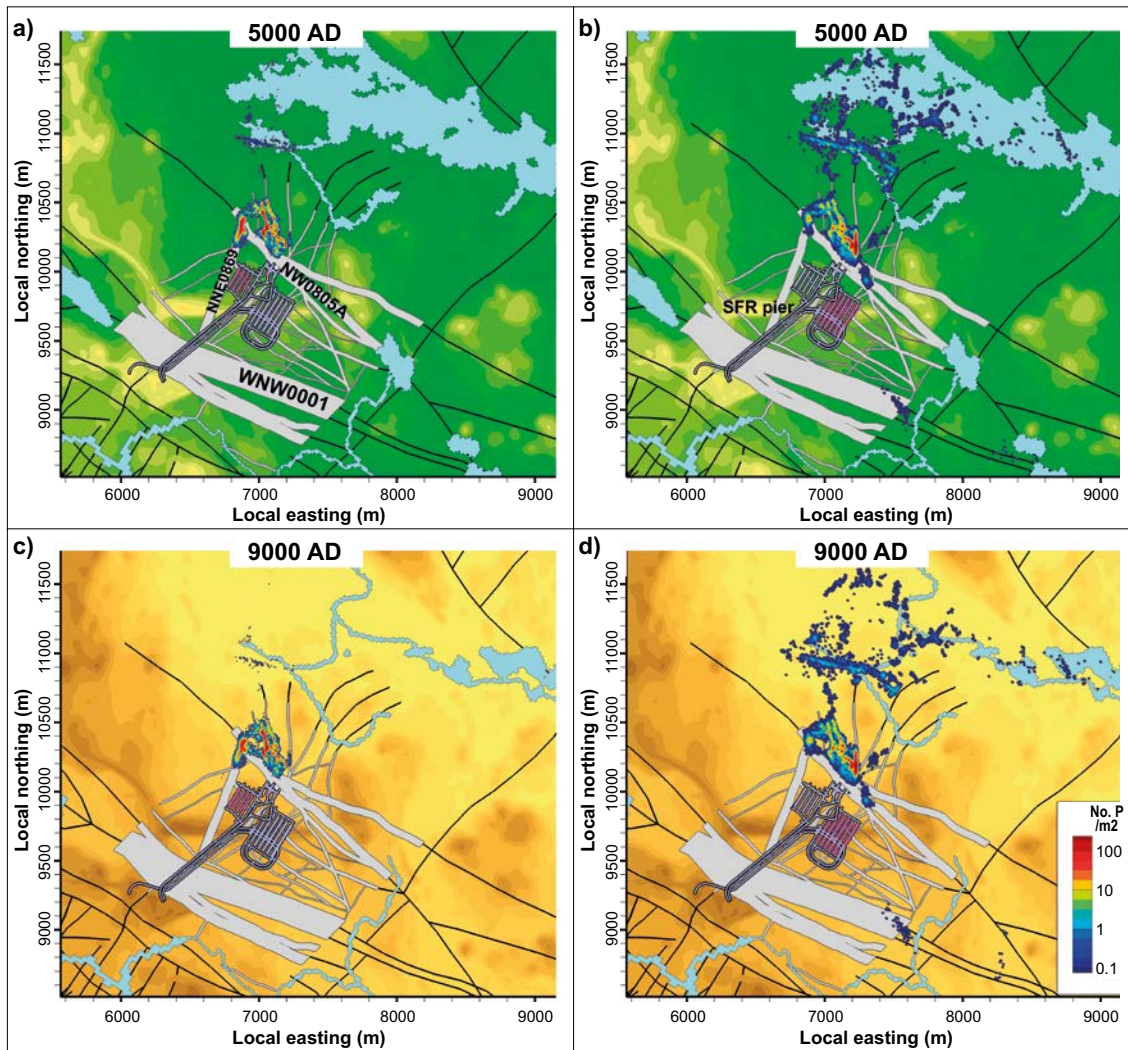
Future human actions may have impact on the groundwater flow system. Groundwater abstraction from a borehole may change the flow field in the vicinity of the borehole and lower the water table locally. The effects can extend for some distance from the borehole, if it is drilled into a major permeable deformation zone, which is usually attempted (in order to be able to abstract as much water as possible). If the repository is located within the zone of influence of a water-abstraction borehole (taking into account the effects of intersected fracture zones), then the flow through the repository may be affected by the abstraction. Vaults, tunnels and shafts are likely to have a similar but greater effect on groundwater flow than water abstraction from boreholes. Activities that may affect groundwater flow are further discussed in Chapter 7 and in the **FHA report**.

#### 6.4.5 Near-field hydrological evolution

Transition from the shoreline domain to the terrestrial domain increases the repository vault flows by approximately 50–100% (see Figure 6-8). Once terrestrial conditions (Shoreline position 3) prevail above the repository, the groundwater flow is assumed to reach a steady-state.

##### **Impact of concrete barrier degradation**

The impact of concrete degradation on the water flow through the repository has been studied by assigning an increasing hydraulic conductivity to the concrete materials in the vaults. The initial state of the concrete and a completely degraded state were set as limits for this parametric investigation (Abarca et al. 2013). In the completely degraded state it is assumed that the concrete no longer constitutes a flow barrier.



**Figure 6-19.** Exit locations (coloured by particle density, bottom right) for particles starting in the SFR 1 waste vaults (pink shade; left) and in the SFR 3 waste vaults (pink shade; right), time slices 5000 and 9000 AD. The black lines represent deformation zones. The white areas also represent deformation zones, but zones closer to the SFR repository where the width of a white area indicates the zone thickness at ground surface.

The flows through the BLA vaults are not affected by the degradation of concrete, as they do not have such barriers. The silo also displays a more or less constant flow rate through the waste for all investigated degradation states of the concrete. This is because even though the internal structure is made of concrete, the silo remains protected by the external flow barrier of bentonite.

As concrete degradation progresses the fraction of the vault flow that passes through the waste increases. In the 1BTF and 2BTF vaults, the flow through the waste increases by approximately one order of magnitude going from the initial state to a state where the concrete no longer restricts flow. Degradation also affects the longitudinal distribution of flow through the vaults. In the initial concrete state, there is a clear correlation between the local flow through the waste and the deformation zones in the rock (Abarca et al. 2013). In a moderate degradation state, the longitudinal distribution of flow remains the same but with an increased flow in the sections affected by the fault zones. As concrete degradation continues to progress, flow through the waste increases. The flow profiles show less structure, indicating a more evenly distributed flow through different sections of the waste vault (see Figure 6-20).

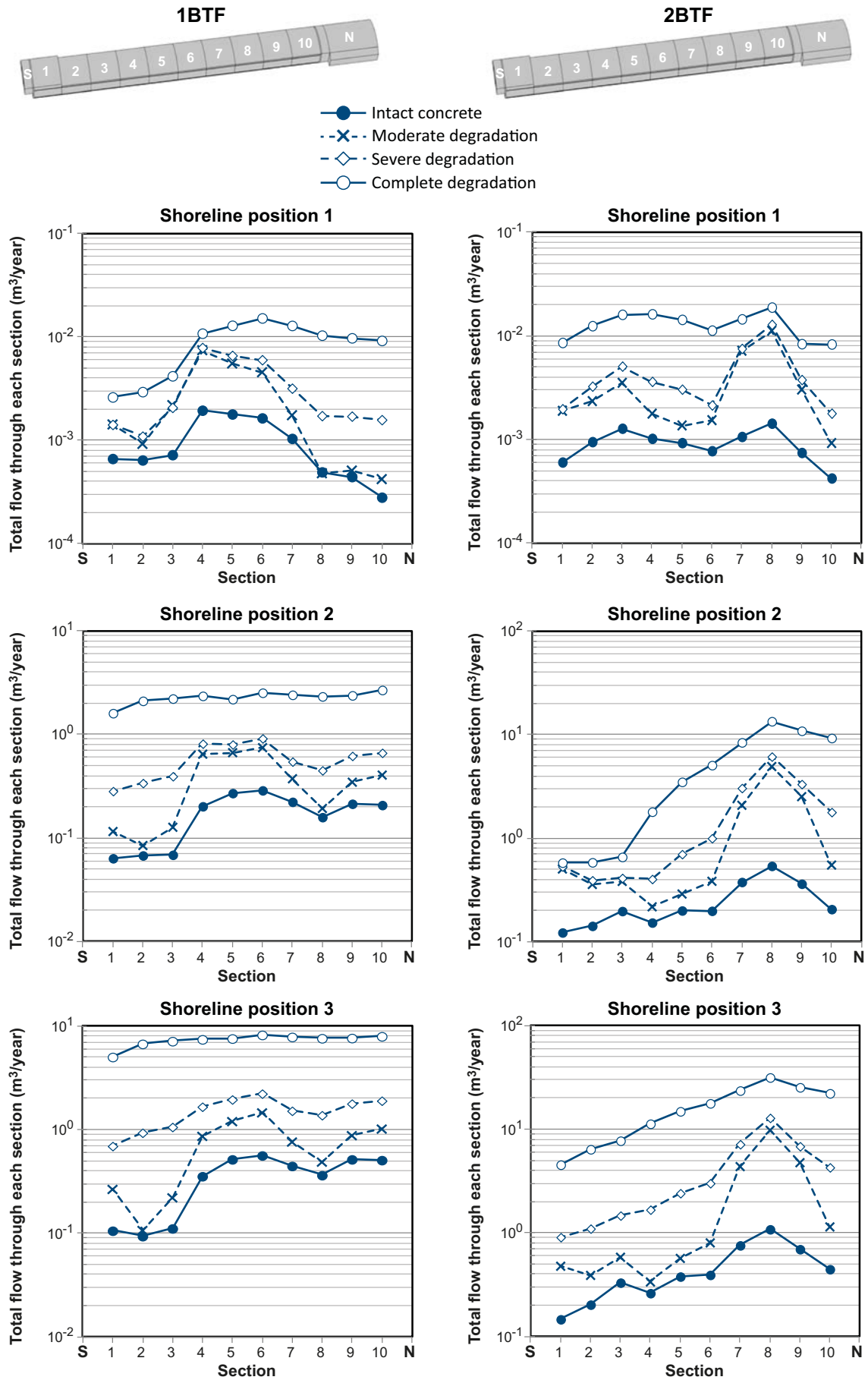


Figure 6-20. Total flow (m<sup>3</sup>/year) in sections of 1BTF (left) and 2BTF (right) for the three shoreline positions.

The BRT and BTF vaults are represented in a similar way in the near-field models (see Abarca et al. 2013). Hence, flows through the waste domain as a function of concrete degradation are also similar. It should be noted, however, that several mechanisms in addition to advective transport contribute to the net release of radionuclides from the vaults. The BTF vaults contain, to a large extent, dewatered ion-exchange resins packaged in concrete tanks. Once the tanks no longer resist flow, the radionuclides can be transported by the penetrating water. However, even degraded concrete will retain radionuclides in the vaults due to sorption. The waste in the BRT vault consists of reactor pressure vessels made of steel, with induced activity in the metal. The release of radionuclides therefore also depends on the corrosion rate, which is kept at a minimum due to the high pH conditions set by the concrete in the vault. This serves to illustrate the fact that even though two vaults experience a similar increase in flow through the waste due to concrete degradation, the actual release rates of radionuclides may differ because of the differing waste matrices.

The 1BMA and 2BMA vaults rely on a hydraulic contrast to redirect water flow away from the concrete barriers. The waste compartments in 1BMA are immediately adjacent to one another, and a high permeability material is installed underneath, on the sides, and on top of the concrete structure. The concrete waste compartments in 2BMA constitute individual units, separated by a high permeability backfill. Modelling results point to the effectiveness of this design (Abarca et al. 2014), with flows through the waste on the order of litres per year or less. With such low flows through the waste as a reference point, any disturbance in barrier performance will produce a large relative impact on the flow. However, the absolute flow through the waste may still be modest. An order of magnitude increase in the hydraulic conductivity of concrete yields approximately an order of magnitude increase in the flow through the waste. For severely degraded concrete barriers, the hydraulic contrast still contributes to direct 80% or more of the vault flow through the backfill.

### ***Degradation in sealed hydraulic sections of bentonite***

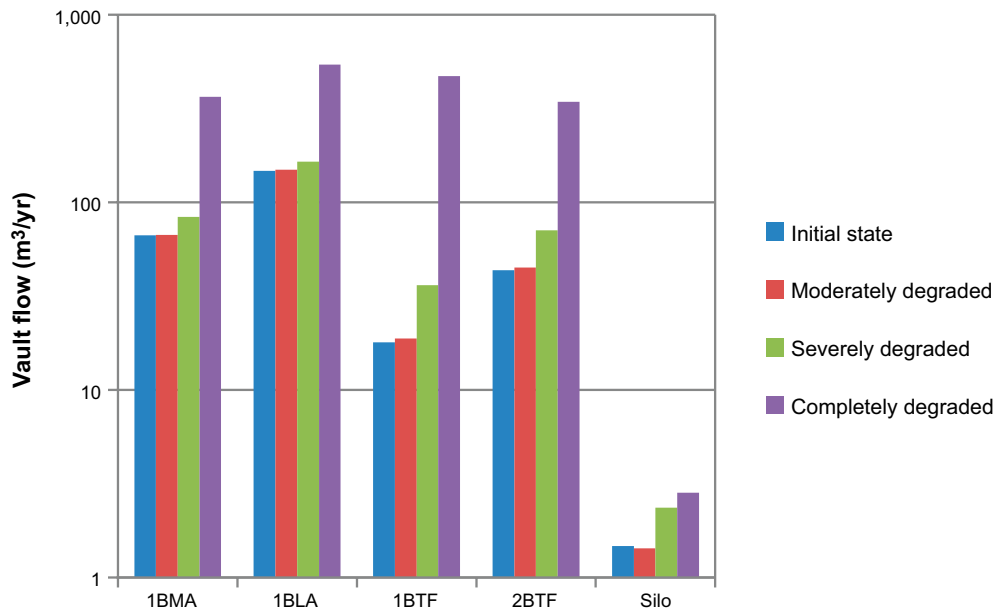
In order to restrict water flow through the waste vaults, the tunnel sections closest to the vaults will be sealed with sections of bentonite. These sections are supported by mechanical plugs. The hydraulic properties of bentonite can degrade due to various processes (this is further described in the **Barrier process report**). The degradation of supporting mechanical plugs may permit swelling of the bentonite section, reducing the internal swelling pressure and increasing the hydraulic conductivity. The sealing capacity of the bentonite may also be affected by the water flow, carrying away material (erosion) and creating channels in the clay (piping). Chemical processes may furthermore cause montmorillonite alteration, which reduces the swelling capacity of the bentonite.

The impact of the degradation of sealed hydraulic sections of bentonite on the water flow through the repository has been studied by assigning an increased hydraulic conductivity to the bentonite sections in the repository. The initial state of bentonite and a completely degraded state were taken as limits for this parametric investigation (Abarca et al. 2013). In the completely degraded state it is assumed that the bentonite no longer constitutes a flow barrier.

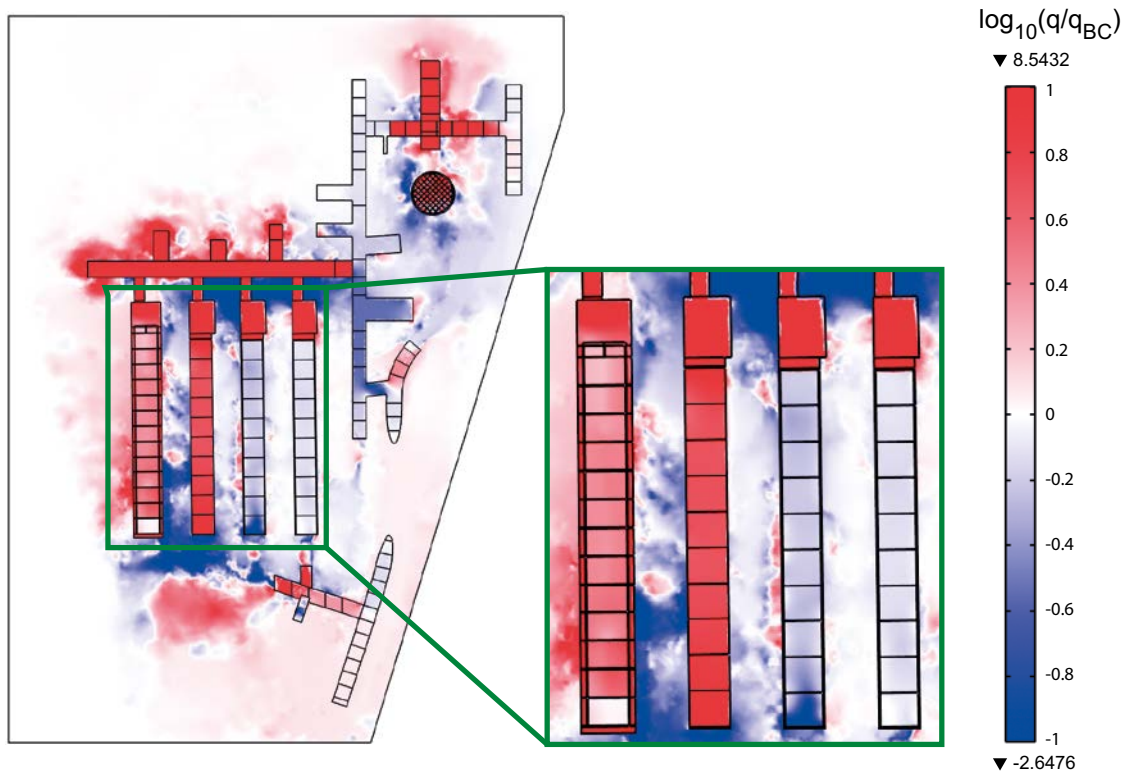
The calculated flows through the vaults in SFR 1 are presented in Figure 6-21.

Moderately degraded bentonite has little impact on flow through the vaults. The most notable effect of the severely degraded bentonite state is a doubling of the flow through the vault for 1BTF. When the bentonite is completely degraded, the flow increases several-fold in most vaults, with a one order of magnitude increase observed for the 1BMA and BTF vaults.

When the plugs are intact, the water reaches the vaults in SFR 1 mainly through deformation zones in the rock. These zones also connect vaults and distribute flow among them. As the bentonite degrades, the water flow is redistributed and the preferential flow paths are along the access tunnels and the highly permeable backfill in the vaults. At the same time, the flow decreases in the rock structures intersecting the vaults. The redistribution of flow is illustrated in Figure 6-22. The plot illustrates the increasing flows in the entire 1BLA vault and porous backfill of 1BMA. However, the BTF vaults, which exhibit the greatest increase in flows through the vaults as the bentonite degrades, display an increase in flow mainly in the loading areas, whereas flows through the waste domain actually decrease slightly.



**Figure 6-21.** Flow ( $m^3/yr$ ) through the vaults in SFR 1 as function of bentonite degradation.



**Figure 6-22.** Comparison of the logarithm of the ratio of the Darcy velocity magnitude for completely degraded sections of bentonite and the initial state at the terrestrial position, in a horizontal cross section at 82.5 m depth. Values greater than zero indicate a higher flow in the case of completely degraded bentonite.

The calculated flows through the vaults in SFR 3 are presented in Figure 6-23. The impact on the flow of water through the vaults is moderate, even with completely degraded bentonite sections. In general, there is less of an effect than observed for SFR 1. The difference in vault flow between completely degraded and intact bentonite sections (initial state) decreases with distance from the access ramp. The BRT vault, closest to the access ramp, shows a three-fold increase in vault flow for the case of completely degraded bentonite sections as compared to the initial state.

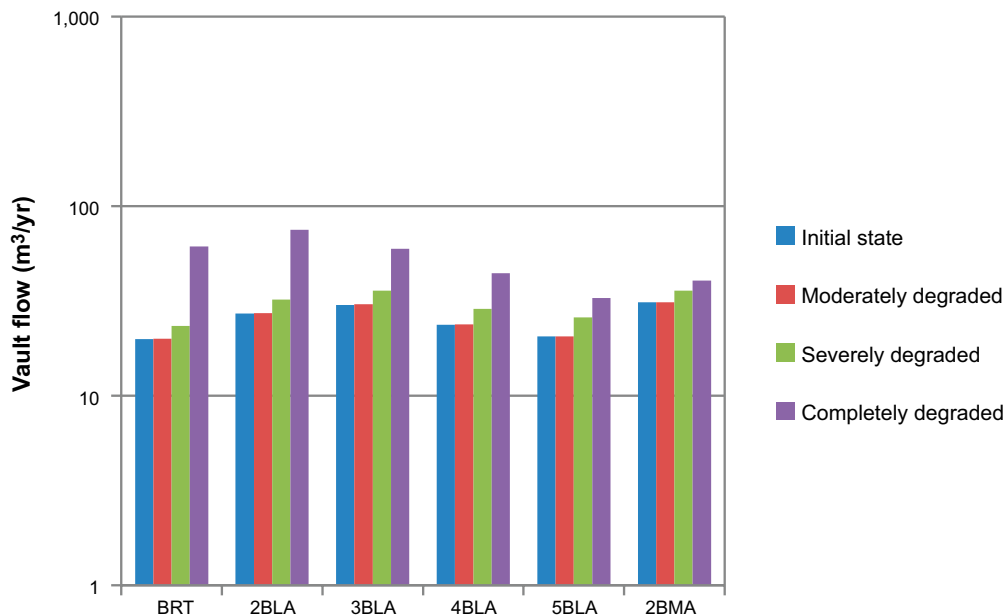


Figure 6-23. Flow ( $m^3/yr$ ) through the vaults in SFR 3 as a function of bentonite degradation.

#### 6.4.6 Geochemical evolution

The brackish groundwater in the bedrock surrounding SFR may start to change and become more and more diluted with time, as the shoreline becomes located further east. During this period, the groundwater composition will be influenced by the introduction of meteoric water into the uppermost part of the bedrock, promoting dissolution of e.g. pyrite and precipitation of Fe(oxy)hydroxides. Further uplift above the sea level will affect the groundwater flow pattern through dynamic changes in hydraulic properties and changes in the direction of groundwater flow, from being a discharge area to a situation with more horizontal groundwater flow (Section 6.4.4).

The extent and direction of solute transport by advection will hence change in response to the prevailing groundwater flow field (**Radionuclide transport report**). Liquid-phase diffusion in stagnant water may continue to be of importance for radionuclide retention (**Geosphere process report**), but the process will probably be more important for the evolution of the groundwater composition in the long-term.

During periods of temperate climate domain, dissolution/precipitation of fracture minerals will influence the groundwater composition and act as a buffer against acidification and changes in the redox conditions. The groundwater, initially similar to the present brackish marine groundwater, will successively become more and more dilute, especially in the temperate climate periods extending for more than 40,000 years (Table 6-8).

#### 6.4.7 Chemical evolution of the waste

During longer time periods, beyond 1,000 years after closure, the chemical evolution is of importance for the release of radionuclides and other species, particularly with regard to sorption. The point of departure for the chemical evolution during longer time periods under temperate conditions is the evolution that has taken place during the first thousand years. The following description is thus a continuation of Section 6.3.7. The background to the assessments described in the preceding section is not repeated here.

Among the external changes that have a bearing on the chemical evolution is the fact that the groundwater after about 1,000 years is expected to be fresh water, see Section 6.4.6. The altered direction and magnitude of water flow due to land uplift is also of importance for many processes.

**Table 6-8. Expected composition of shallow groundwater in the SFR area during both temperate and periglacial periods when the repository is not covered by the sea (based on site data from shallow groundwaters (0–100 m.b.s.l.) in terrestrial areas). Table modified from Auqué et al. (2013).**

	Reference composition	Range	Range
	For the period until approximately 40,000 years		For the period extending beyond 40,000 years
pH	7.4	6.6–8.3	6.6–8.3
Eh (mV)	–210	–135 to –300	–135 to –300
Cl <sup>–</sup> (mg/L)	190	16–503	5–357
SO <sub>4</sub> <sup>2–</sup> (mg/L)	50	25–163	17–110
HCO <sub>3</sub> <sup>–</sup> (mg/L)	300	300–500	120–324
Na <sup>+</sup> (mg/L)	180	65–400	38–250
K <sup>+</sup> (mg/L)	5	5–15	2–5.3
Ca <sup>2+</sup> (mg/L)	50	24–105	7–48
Mg <sup>2+</sup> (mg/L)	12	7–24	2–13
SiO <sub>2</sub> (mg/L)	12	2–21	12–31

### **Evolution of the waste domain**

Based on the calculations that have been carried out regarding leaching of concrete in the waste domain, concrete moulds and cement matrices are not expected to be subjected to significant leaching of cement components during the period up until 12,000 AD (end of the simulated study period) (Höglund 2001) and for the silo vault up until 100,000 AD (Gaucher et al. 2005). However it cannot be excluded that local mineral alterations at the surface of the concrete packaging can take place, see Cronstrand (2014, Section 6.4.8), the pH of the different waste domains shows no variation, since it is determined by the portlandite equilibrium.

### **Water composition**

#### **Groundwater**

Land uplift has proceeded so far that the groundwater flowing into the repository will be fresh (non-saline) throughout the period. For details about the composition of the groundwater, see Section 6.4.6 and Table 6-8.

#### **Cement porewater**

According to Cronstrand (2014), the pH will stay at approximately 12.5, corresponding to buffering by portlandite dissolution in all waste domains, except for 1BLA, in SFR 1 for at least 100,000 years, see Table 6-5. In 1BLA, the pH will gradually decrease, due to the lack of concrete structures, and finally reach the pH of the intruding groundwater after about 19,000 years. The pH in the concrete walls surrounding the waste domain of 1BMA will gradually decrease and reach a value of 11.5 after 48,000 years in compartments with bituminised waste and 56,000 years in compartments with cement-conditioned waste. The modelling performed by Cronstrand (2014) uses a simplistic stirred reactor tank approach for the examined compartments, silo wall, silo waste domain, 1BMA wall, 1BMA bitumen-conditioned waste compartment, 1BMA concrete-conditioned waste compartment, 2BTF, 1BTF and 1BLA. The model also accounts for the influence on pH by the waste i.e. potential ions that might influence the pH from ion-exchange resins are taken into account. In the model, the shotcrete surrounding the rock vaults has been credited as a pH-governing material.

It is emphasised that the method is an approximate and conservative approach used solely to determine the global average pH evolution. Substantial local deviations are expected due to the inhomogeneous character of the waste compartments, flow path restrictions etc. Nevertheless, in spite of the uncertainties associated with each set of input data, the results show a significant stability with respect to variation of the input data as long as portlandite and CSH stabilise the pH.

## Waste leachate

In the case of cement-conditioned waste, the leachate is expected to be dominated by the soluble species in the cement and the pH will be affected by the waste and the amount of cement present, see Table 6-5..

## Fluxes of aqueous species

The release of radionuclides and the salts contained in the bitumen matrix will be dependent on the supply of water. In SR-PSU it is assumed that all radionuclides will have been released from the bitumen matrix within the previous time period. Therefore, radionuclides are not considered to be retained in the bitumen matrix during this period.

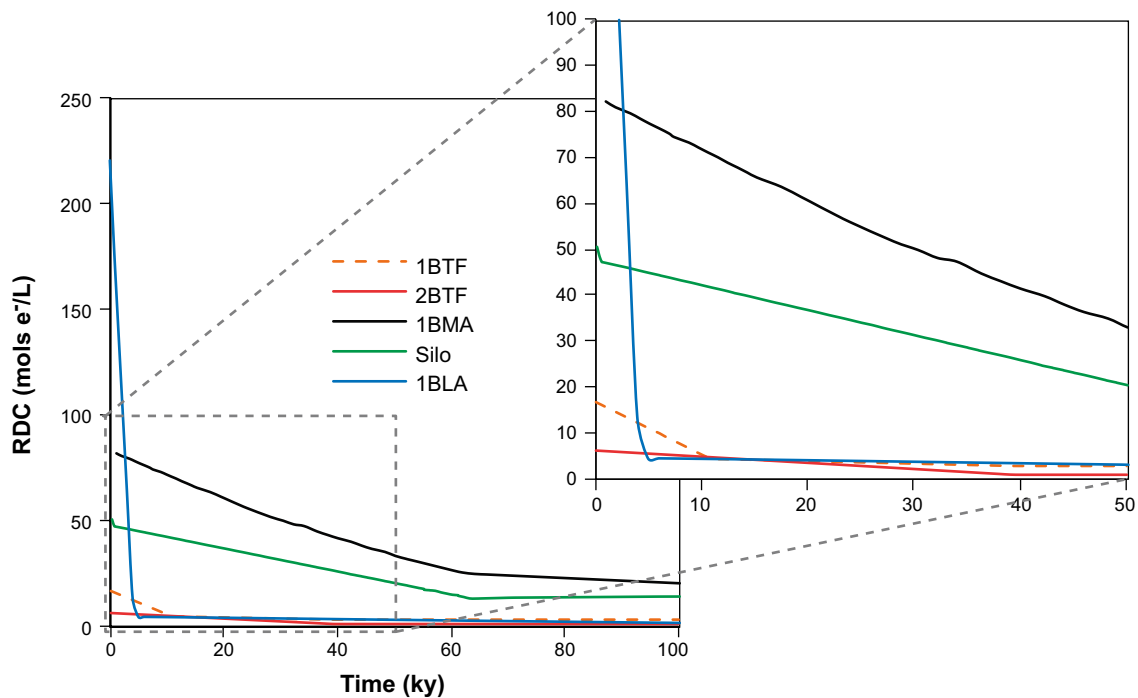
## Colloids

See water composition for the initial 1,000 years.

## Redox

Reducing conditions are assumed to prevail in all barriers and during the entire period in all waste vaults, see preceding period "Redox". The time required for exhaustion of all steel contained in the vaults varies from 5,000 years in 1BLA to more than 60,000 years in 1BMA and the silo, depending on the amount and surface area of the steel. After the complete corrosion of steel, the system still possesses a high reducing capacity due to the magnetite previously formed as a steel corrosion product, see Figure 6-24. As long as there is RDC (reducing capacity) left in the system, the redox potential will be low. The amount of electrons, which is how the reducing capacity of the system is represented, gives an idea of the amount of oxidants that the system can buffer as indicated below:

- 1BLA: 56.25 moles of oxygen/ L waste.
- SILO: 12.5 moles of oxygen/ L waste.
- 1BMA: 20 moles of oxygen/ L waste.
- 1BTF: 4.5 moles of oxygen/ L waste.
- 2BTF: 1.5 moles of oxygen/ L waste.



**Figure 6-24.** Temporal evolution of the reducing capacity (RDC in moles  $e^-/L$ ) calculated for each of the vaults, 1 and 2BTF, 1BMA, silo and 1BLA.



### **Radionuclide speciation**

As the pH decreases, the speciation of some radionuclides will change. This is reflected in changed  $K_d$  factors for the affected elements (see the **Data report**). Reducing conditions in the repository persist during the whole period and the speciation of the redox-sensitive radionuclides does not change.

### **Metal corrosion**

The initial rapid corrosion of aluminium and zinc is completed and corrosion of iron is the dominant corrosion process during the period. The redox conditions in all waste vaults are still reducing and the corrosion rate is still 0.05 and 0.01  $\mu\text{m}/\text{yr}$  for carbon steel and stainless steel, respectively.

### **Organic complexing agents and sorption**

During the period following 1,000 years after closure, sorption effects due to complexation with organics present in the waste at closure become less important. This is due to the transport of such species out of the waste domain. Degradation of cellulose continues, and all cellulose is expected to be degraded roughly 5,000 years after closure, see Table 6-9. The impact of the presence of ISA on sorption ( $K_d$  values) is taken into account during the whole period with the sorption reduction factors presented in Table 6-6. The complexation also becomes less important because almost all radionuclides have decayed and C-14, Tc-99 and Ni-59 are the only remaining dominant radionuclides. These radionuclides do not form strong complexes with organics.

**Table 6-9. ISA concentrations after 5,000 year of cellulose degradation (sorption of ISA on available hydrated cement is taken into account (Keith-Roach et al. 2014)).**

	ISA Concentration (M)
<b>1BMA</b>	
Compartments	
1	0
2	0
3	$3.1 \cdot 10^{-5}$
4	$2.7 \cdot 10^{-4}$
5	$1.5 \cdot 10^{-6}$
6	$8.0 \cdot 10^{-6}$
7	$1.5 \cdot 10^{-4}$
8	$1.2 \cdot 10^{-2}$
9	$4.6 \cdot 10^{-4}$
10	$9.2 \cdot 10^{-4}$
11	$5.2 \cdot 10^{-4}$
12	$5.2 \cdot 10^{-4}$
13	$5.3 \cdot 10^{-4}$
14	$5.1 \cdot 10^{-4}$
15	$5.1 \cdot 10^{-4}$
Total 1BMA construction	$2.9 \cdot 10^{-4}$
1BMA vault incl. macadam and shotcrete	$2.7 \cdot 10^{-4}$
<b>2BMA</b>	
2BMA per caisson (waste deposited in 8.4 caissons)	$2.6 \cdot 10^{-4}$
<b>Silo</b>	
Within the outer walls of the silo construction	$4.5 \cdot 10^{-5}$
Silo construction	$3.8 \cdot 10^{-5}$
Entire vault	$3.8 \cdot 10^{-5}$
<b>1BTF</b>	
Waste zone	$4.7 \cdot 10^{-6}$
Entire vault	$4.5 \cdot 10^{-6}$
<b>2BTF</b>	
Waste zone	0
Entire vault	0

## **Microbiology**

As the pH of the system controls the microbial activity to great extent, extensive microbial activity will not occur until pH has dropped to optimum pH for microbial activity. Nevertheless, the pH in the repository will still be unfavourable for microbial activity during this period. The time scale or time scales on which microbial processes occur is related to the amount of available nutrients and energy sources in the system. As regards the BLA waste vaults, the possibility cannot be excluded that microbial activity will be extensive after about 19,000 years when the pH has dropped to groundwater levels.

## **Gas formation**

### **Gas formation due to corrosion**

For the period following 1,000 years it is foreseen that all aluminium and zinc will have corroded. Anaerobic corrosion of iron will be the dominating gas producing process during this period.

### **Gas formation due to microbial activity**

Microbial activity will increase as the pH decreases. Nevertheless, the pH in the repository will still be unfavourable for microbial activity during this period. The exception is 1BLA, where the pH will be the same as in groundwater after about 19,000 years.

### **Gas formation due to radiolysis**

Gases generated due to radiolysis of water and other materials are negligible also during this period.

## **Calculated gas quantities**

After all the aluminium and zinc have corroded, the gas volumes that are generated are significantly lower. For the period after the first 1,000 years, gas generation is dominated by either degradation of organic material and/or steel corrosion. The gas volumes ( $\text{Nm}^3/\text{yr}$ ) vary between 10 and 275  $\text{Nm}^3/\text{yr}$  between the different waste vaults in SFR 1 (Moreno and Neretnieks 2013).

## **Gas transport**

Gas transport through the porous material of the matrices will continue according to the description in the section on Gas formation in Section 6.3.7.

## **6.4.8 Evolution of engineered barriers**

### **Bentonite barriers**

Montmorillonite is gradually transformed in contact with water with a high pH. After 10,000 years, a third of the total amount of montmorillonite in the bentonite has been dissolved and after 100,000 years only a small part remains. Calcium silicate minerals, zeolites and new clays will form in the bentonite at the interfaces to the concrete silo and the shotcrete on the rock walls and roof. These minerals have slightly different properties compared with the original montmorillonite, such as inferior swelling properties and higher molar volume (Gaucher et al. 2005). The possibility cannot be ruled out that the extent of the transformation is so large that the bentonite barrier loses its swelling capacity during this period, which could lead to a higher risk of fracturing and higher hydraulic conductivity. The changes in porosity and mineral composition caused by the transformation processes are not expected to lead to higher diffusion coefficients than for unaffected barriers. When it comes to sorption, the values used are based on the occurrence of a sufficient fraction of bentonite for all time scales and the minerals likely to form, such as zeolites with generally high sorption of cations, are judged to have at least as good sorption properties as the original minerals. The values chosen for the unaffected bentonite barriers are, therefore, cautiously assumed to be representative for the entire assessment period.

### Bentonite colloid formation

Even for the longest time frame considered in the assessment of repository safety after closure (up to 100,000 years), sufficiently high  $\text{Ca}^{2+}$  concentrations are expected at the interface between bentonite and shotcrete to avoid the dispersion of clay and the formation of a clay sol (Gaucher et al. 2005). This process is therefore not deemed to have any significant impact on the design used in the silo. Based on these results, the safety assessment does not consider the possible impact on the bentonite from changes in groundwater composition. This could be caused for example by increased recharge of meteoric water during long periods, as in the climate cases of *global warming* and *prolonged global warming* (Climate report, Sections 4.1 and 4.3).

### Cement degradation in the concrete wall

No major changes in the volume of the silo wall are expected during the first 100,000 years or more after closure (Gaucher et al. 2005). Bentonite expansion/intrusion into the silo walls can thus be neglected.

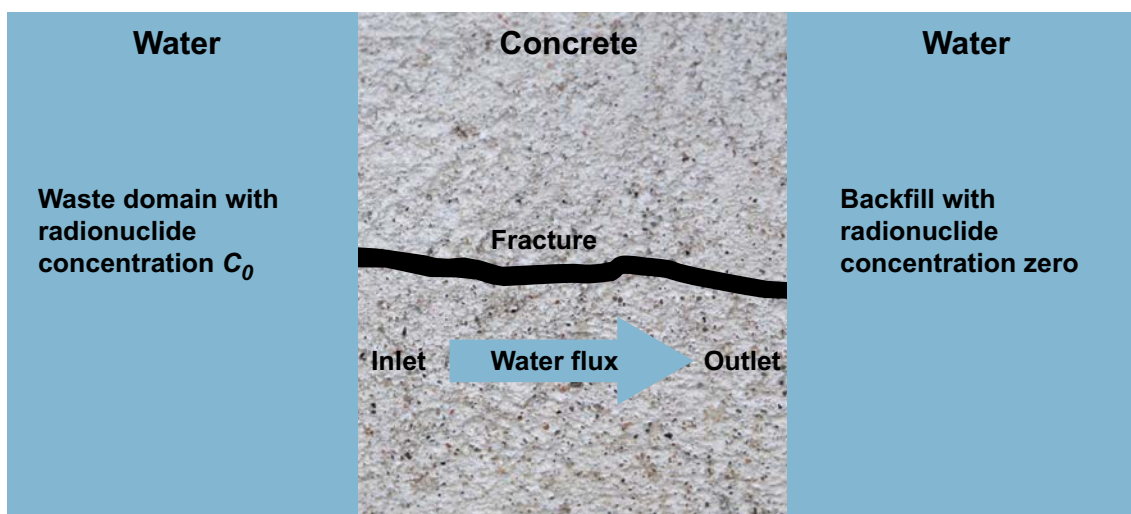
### Concrete barriers

#### Local concrete degradation

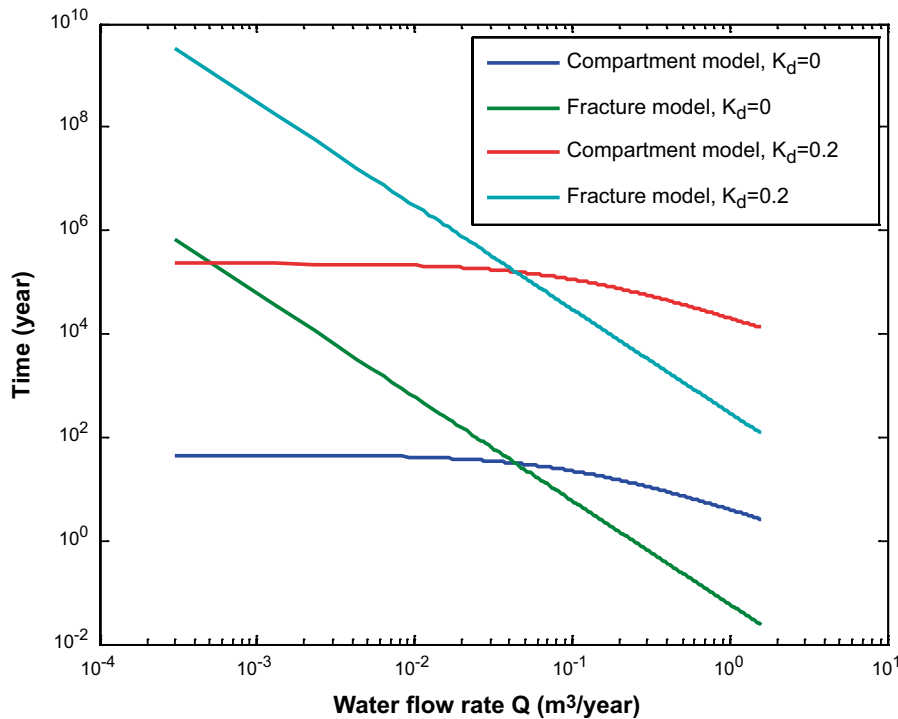
The occurrence of fractures results in a local flow that increases the concentration gradient, which in turn can accelerate dissolution and subsequent diffusive transport of dissolved cement minerals. As the portlandite-depleted zone near the fracture expands, the zone will eventually be able to propagate throughout the entire concrete barrier. This may lead to an increased hydraulic conductivity in the fracture, which can be regarded as an effective widening of the fracture and can result in a more localised flow through the concrete barrier, see also Section 6.3.8.

A sorbing nuclide with an initial concentration  $c_0$ , which is led into a fracture where advection is considered to be the most important transport mechanism through the barrier will, after some delay, emerge at the outlet, see Figure 6-25. The concentration of radionuclides in the outlet from the fracture has been calculated by Neretnieks and Moreno (2013) and the time to reach half the steady-state concentration is shown in Figure 6-26.

In the case of radionuclide transport through a porous barrier, the retention of radionuclide release due to sorption can be calculated with a compartment model (**Radionuclide transport report**) and the time to reach half the steady-state concentration at the outlet of the fracture is also shown in Figure 6-26.



**Figure 6-25.** Water-bearing fracture through a concrete barrier



**Figure 6-26.** Time delay as a function of flow through a fracture and a compartment for different  $K_d$  values. The time to reach half the steady-state concentration at the outlet is calculated with two different models. The properties assumed for the concrete wall in the calculations are taken from the Data report. The geometry investigated is a 2BMA concrete wall, see the **Initial state report**, with one fracture per metre.

A comparison between the time to reach half the steady-state concentration at the outlet from the fracture model and the compartment model can be used to estimate when the compartment model overestimates the retention related to sorption (**Radionuclide transport report**). Such a comparison is also useful for assessing when fractures will have an effect on the available sorption surface area. The two models are compared in Figure 6-26.

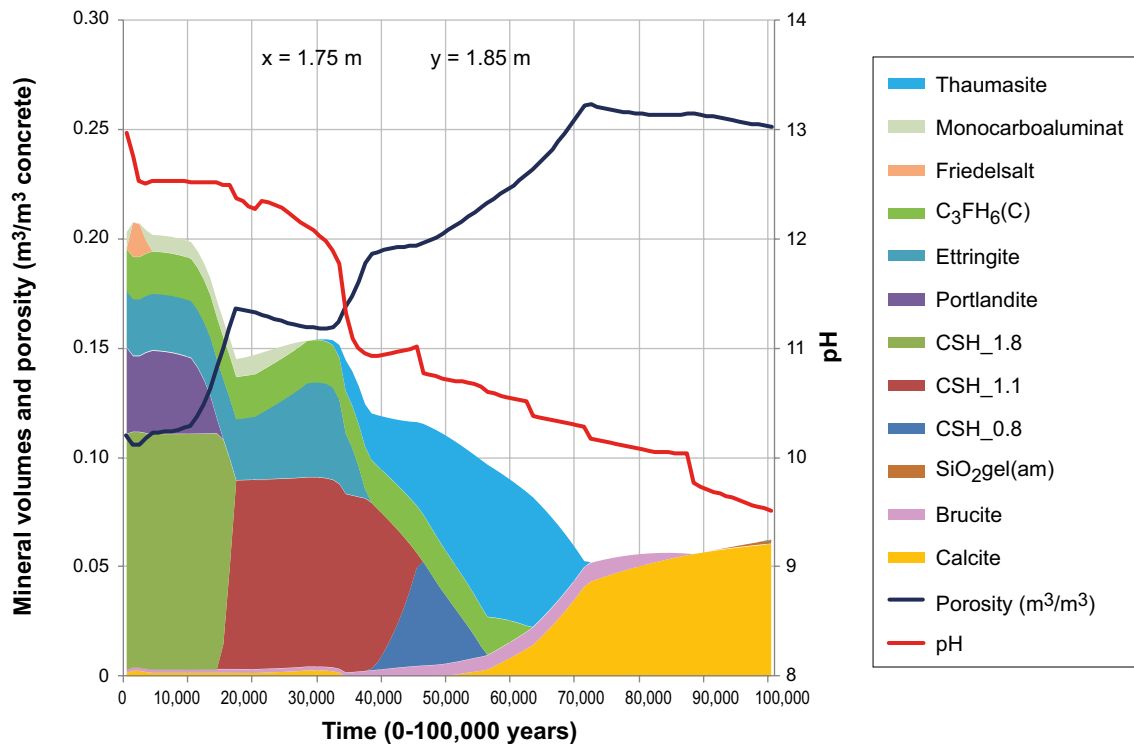
At a sufficiently low flow,  $Q < 4 \cdot 10^{-2}$  [ $\text{m}^3/\text{year}$ ] through a 2BMA caisson, the presence of fractures will not affect the concrete wall's ability to sorb radionuclides. The flows through all concrete barriers are sufficiently low for effective sorption as long as the flow barriers are not completely degraded and the flow becomes concentrated to a few large fractures.

### Concrete degradation

The evolution of mineral composition, pH and porosity in the middle of the concrete barrier on the inflow side of the 2BMA construction, which can be regarded as a representative example for the concrete barriers in 1BMA and 2BMA, is shown in Figure 6-27 (Höglund 2014).

As shown in Figure 6-27, both porosity and pH change as a result of changes in the mineral composition, which can be explained by the different molar volume and composition of the minerals.

The change in porosity of the concrete is of importance as it affects both its hydraulic conductivity and the effective diffusivity. The results indicate that an initial concrete porosity of 11% would increase marginally to about 11,5% about 10,000 years after closure. A slight decrease in porosity occurs as a response to an early reaction between  $\text{Cl}^-$  in the groundwater and monocarboaluminate in the concrete. This leads to the precipitation of Friedel's salt, a process that begins after about 300 years and is completed at 700 years after closure. The reaction also consumes some portlandite in the concrete. From 2,300 to 3,300 years after closure, Friedel's salt decomposes and monocarboaluminate and portlandite are re-formed. There is no significant change in the amount of ettringite during the first 10,000 years and hence the risk of fractures due to ettringite formation is low. Significant changes in the amount of ettringite and thaumasite which could cause fracturing occur first during the period from 20,000 years up to about 70,000 years.



**Figure 6-27.** Change in mineral volumes and porosity over time in the middle of the most degraded concrete walls in 2BMA. Time is given in relation to the present, where 0 corresponds to 2000 AD (Höglund 2014).

After 10,000 years, the occurrence of substantial portlandite leaching causes a steady increase of the porosity to about 14% at 15,000 years, when portlandite is depleted. The porosity continues to increase to 17% after 19,000 years, as a consequence of incongruent leaching of CSH\_1.8 which is transformed to CSH\_1.1. Between 19,000 years and 31,000 years, the transformation of monocarboaluminat to ettringite once again reduces the porosity to approximately 16%. After 31,000 years, ettringite and CSH\_1.1 have destabilised and transformed to thaumasite and CSH\_0.8. Ettringite is depleted after 38,000 years and CSH\_0.8 disappears after 56,000 years. The porosity increases during this period to about 21% and reaches a maximum value of about 26% after 72,000 years, after which it slowly decreases to about 25% at 100,000 years. Thaumasite increases steadily from 31,000 years to 56,000 years, when a decrease begins. Thaumasite is completely depleted after 72,000 years. The iron-substituted hydrogarnet phase  $C_3FH_6$  remains passive until 38,000 years, when a small amount of precipitation starts, to reach a peak at 46,000 years, followed by dissolution and depletion after 63,000 years. From 32,000 years, an increased precipitation of brucite will be observed. A peak in the amount of brucite occurs at 70,000 years, after which dissolution starts, which eventually leads to depletion of brucite after 88,000 years. After 48,000 years calcite starts to precipitate, a process that will still be in progress at 100,000 years. A small formation of amorphous silica  $SiO_2$  gel(am) is noted from 91,000 years and onwards.

Significant changes in the amount of ettringite and thaumasite show that there is a risk of fracturing, but it occurs only after 20,000 years up to about 70,000 years and is therefore considered to be a long-term effect.

Calculations (Gaucher et al. 2005, Cronstrand 2007) show that after 100,000 years the portlandite has been completely leached out from the surface of the silo walls and calcium silicate hydrates have been transformed. Only the first step in the transformation has occurred in the innermost part of the silo walls, i.e. the portlandite has been leached out, but CSH\_1.8 remains. In the middle, a second step in the transformation has occurred (CSH\_1.1 has replaced CSH\_1.8), and in the outermost part the third step in the transformation has also occurred (CSH\_0.8, also called tobermorite, has replaced CSH\_1.1) (Gaucher et al. 2005). As long as the leaching has not progressed longer than to these calcium silicate hydrates, the silo walls can be considered a concrete material in terms of material and sorption properties.

A higher water flow is expected through the concrete tanks in the BTF vaults than through the concrete moulds in 1BMA, see Section 6.4.5. Higher water flow entails more rapid concrete degradation. After 1,000 years, an extensive chemical degradation of the BTF tanks is expected, which entails a large change in their porosity and hydraulic conductivity. According to the hydrogeological calculations, the water flow through the waste in the BTF vaults is expected to increase with one order of magnitude compared with the situation when the concrete keeps the same hydraulic conductivity as during the first 1,000 years.

### **Water composition in the concrete barriers**

The composition of water in the concrete pore water at the inflow side of the concrete barriers is determined by the interaction between groundwater and concrete. The gradual evolution of water composition has been evaluated (Höglund 2014) and the pH evolution is shown in Figure 6-27. The composition of water in the concrete pore water at the outflow side of the concrete barriers is strongly affected by the interaction between water and waste, see Section 6.4.7. The evolution of pH on the outflow side of the barriers differs from the evolution on the inflow side of the barriers, which explains why the pH evolution presented in Table 6-5 differs from the pH evolution in Figure 6-27.

## **6.5 Periods of periglacial climate domain more than 1,000 years after closure**

During periods of periglacial climate domain permafrost is present at the surface above SFR. The permafrost can be continuous or discontinuous with unfrozen areas (taliks). Periods of periglacial conditions, which are characterised by tundra vegetation and permafrost features, correspond to 31% and 34% of the assessment period for the *global warming* and *early periglacial climate cases*, respectively. The periglacial domain often occurs during relatively short periods interrupted by other climate domains (the temperate, in the present cases). The longest uninterrupted period of periglacial conditions starts around 67,000 AD and continues for circa 10,000 years.

As described in Section 6.2.3, the maximum isotherm depth during periods of periglacial climate domain in the early periglacial and global warming climate cases was determined based on a study on the potential for cold climate conditions and permafrost in Forsmark in the next 60,000 years (Brandefelt et al. 2013). At the time of the first occurrence of periglacial climate conditions in the *early periglacial climate case*, around 17,500 AD, the maximum depth of the 0°C isotherm is about 150 m (i.e. below SFR 3). It is however unlikely that bedrock temperatures of -3°C or less, would occur at SFR depth during this period (see the **Climate report** Section 4.2.4). At the time of the first occurrence of periglacial climate conditions in the global warming climate case, around 52,000 AD, bedrock temperatures of -3°C or less cannot be excluded (see the **Climate report** Section 4.2.4).

### **6.5.1 Evolution of surface systems**

When considering climate cases comprising sequences of climate domains in the whole modelled area at Forsmark, it should be noted that the change from one climate domain to another is a smooth transition; see the **Climate report** for a discussion on transitions between domains. In addition, it takes time for the environment and its predominant processes to adapt even to an abrupt change in climate (e.g. Lindborg 2010).

Figure 6-28 shows a modelled periglacial landscape at Forsmark representing 20,000 AD, which coincides with the early periglacial period. The landscape is characterised by other vegetation types than those existing under temperate conditions. However, the locations of lakes and wetlands, which are governed by topography, are the same.

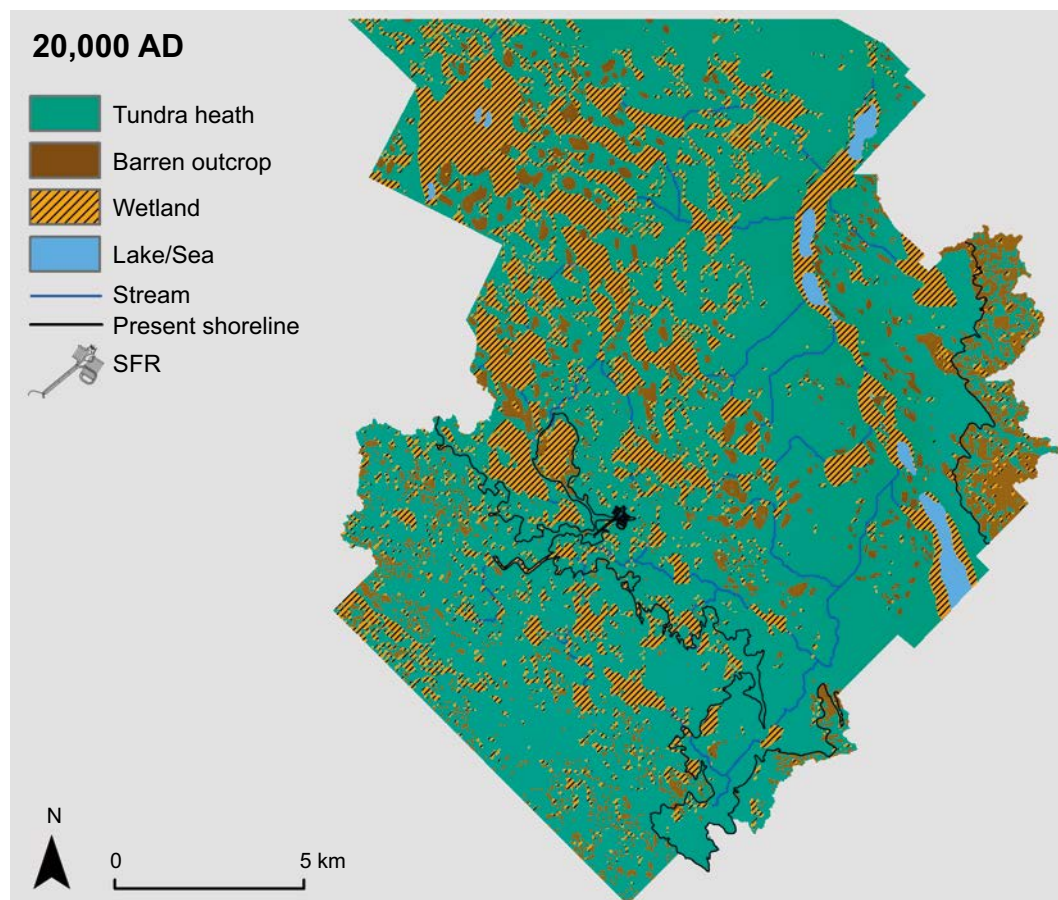
The vegetation period in the periglacial domain is short. Nevertheless, primary production may be high in some environments, e.g. in shallow lakes (Andersson 2010). The terrestrial vegetation consists of sedges, herbs and shrubs. At more exposed and drier localities, lichens dominate, whereas wet ground is dominated by mosses. The precipitation will likely be lower than during temperate conditions, due to the limited evapotranspiration transporting water to the atmosphere (Kjellström

et al. 2009). The low evapotranspiration means that wet ground is prevalent, because surplus water is unable to infiltrate into the ground (Bosson et al. 2010, French 2007). This may result in larger areas of wetlands compared with a temperate climate but, on the other hand, the peat formation rate is lower, partly because the terrestrial plant productivity is low.

Taliks are unfrozen areas, often occurring under lakes or rivers in the permafrost region (see Hartikainen et al. 2010). Through taliks, which are unfrozen throughout the entire permafrost layer, are the only spots in the periglacial landscape where radionuclides potentially released from the repository can be transported up to the biosphere. Given that lakes and streams often are locations for human settlement and land use, taliks can potentially be locations where humans are exposed to radionuclides during periods of periglacial conditions (see Section 6.5.4). However, the generally low productivity in the permafrost region requires utilisation of a larger area to supply the resources needed by even a small community, which means that radionuclide discharge through a talik may affect a comparatively small part of the food consumed by humans living in the talik area.

### 6.5.2 Thermal evolution

The thermal evolution of the repository is controlled by the temperature in the surrounding rock and groundwater, which is in turn controlled by the climate. During periods of periglacial conditions it is possible for temperatures to be low enough for the entire repository to freeze. A ground temperature below 0°C at repository depth cannot be ruled out during the first possible occurrence of permafrost between 17,500 AD and 20,500 AD in the *early periglacial climate case*. A ground temperature of -3°C or less at repository depth cannot be ruled out during the occurrence of permafrost around 52,000 AD both in the *early periglacial climate case* and the *global warming climate case*.



**Figure 6-28.** Modelled distribution of vegetation and land-use in Forsmark at 20,000 AD for the early periglacial climate case. Note that the vegetation types are different from those existing under temperate conditions and that no agriculture is possible; see the **Biosphere synthesis report** for details on the landscape development modelling. The present shoreline is marked as a black line.

### 6.5.3 Mechanical evolution

In the periods of periglacial climate domain, a lower ground temperature and permafrost conditions are expected. This temperature change and the freezing process of the ground water will lead to mechanical processes, including deformation of intact rock, fracture opening and the formation of new fractures (**Geosphere process report** Section 2.2 and Chapter 4). The near-surface air temperature evolution and associated geosphere temperatures during periglacial periods, in the *global warming* and *early periglacial climate cases*, included in the SR-PSU reference evolution, are described in the **Climate report** (Chapter 4).

### 6.5.4 Hydrogeological evolution

During periods of permafrost, the main factor of importance for groundwater flow is the extent of perennially frozen ground. Frozen ground can be more or less impermeable, and the presence of permafrost and a seasonally frozen active layer restricts the infiltration of meteoric water and its recharge to groundwater systems. The presence of frozen ground will also change the locations of recharge and discharge and drive groundwater flow to greater depth. In the vicinity of unfrozen areas, potential gradients may be high.

Under periglacial climate conditions, the most relevant scenarios for the SFR area predict significantly lower total flow through the waste vaults, longer path lengths and travel times and higher flow-related transport resistance values compared with the values under temperate conditions. However, the results are dependent on the extent, position and number of taliks in the flow domain. In consequence, some of the waste vaults may experience small increases in total flows under periglacial relative to temperate conditions. Figure 6-29 illustrates the effect of shallow permafrost on calculated cross flows (total flow through a waste vault) for the different landscape descriptions investigated (see Odén et al. 2014). The lowest cross flows are exhibited for a landscape variant with few open taliks. It is also noted that in a case with many open taliks located close to or above the SFR repository, the total flows through some of the waste vaults are increased compared with temperate conditions. This is especially the case for SFR 3, which for all disposal vaults shows an increase in cross flow.

The exit locations are predominantly found within the physical boundaries of the model domain (see Figure 5-9 and 5-10 in Odén et al. (2014)), and in fact mostly within the lake taliks in the domain. In Figure 6-30, more than 99% of the particles discharge in the taliks to the northeast, whereas some particles discharge through the permafrost layer. In other words, the permafrost has low permeability (bedrock permeability is reduced at most by five orders of magnitude), but it is not impermeable in the assessment modelling. It should also be noted that the deformation zones govern the exit locations in the permafrost.

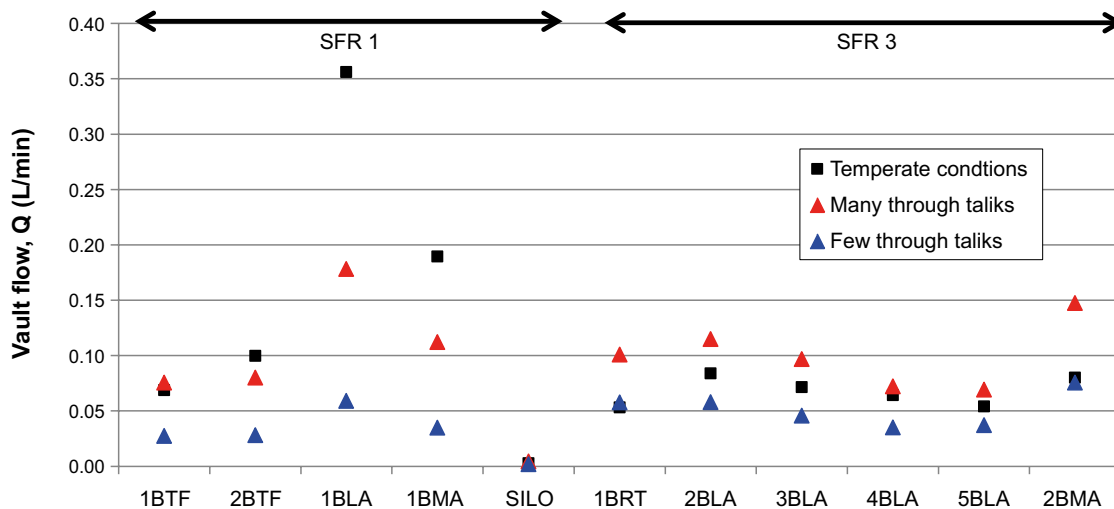
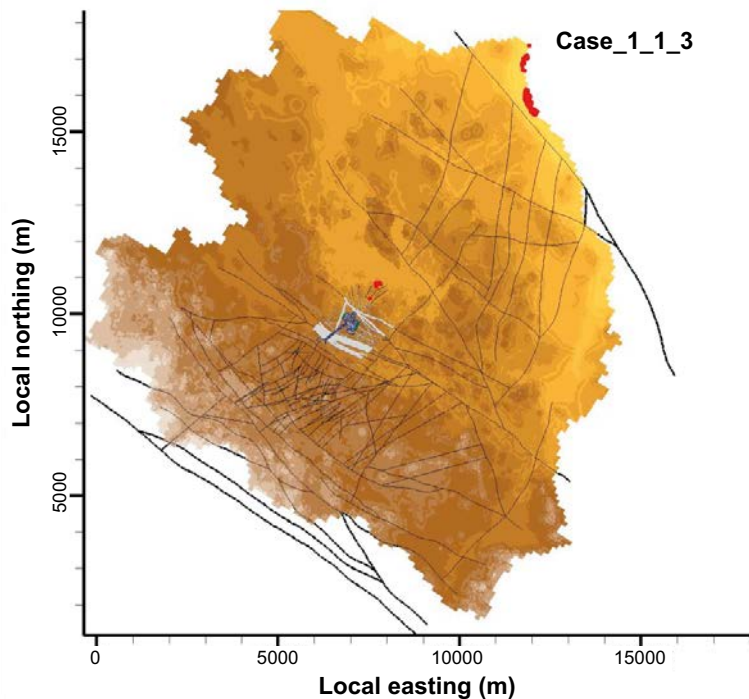


Figure 6-29. Median values of the cross flows through the different waste vault in SFR 1 and in SFR 3.





**Figure 6-30.** Illustration of exit locations for SFR 1 and SFR 3 (red dots) for shallow permafrost (above SFR 1), and the most limited presence of open taliks.

During the earliest periglacial period, in the *early periglacial climate case*, the permafrost is shallow, but its presence at repository depth cannot be ruled out. In the parts of the geosphere that freeze, the hydraulic conductivity will decrease and no significant groundwater flow will occur in the frozen parts. Since the groundwater transports any released radionuclides from the repository, no release into the biosphere should occur during periods of continuous permafrost.

### 6.5.5 Near-field hydrological evolution

The influence of permafrost on the water flow through the repository has been simulated, with the frozen front located above the waste vaults, at a depth of 59 m. The average reduction in the flow through the repository structures is approximately 80% compared with the base case. This value correlates with the average rock permeability decrease around the frozen front. Should the permafrost reach the waste vaults and their structures, the flow of water through the waste will effectively stop.

The internal freezing of water-saturated concrete causes penetrating fractures that loosen up the concrete. This causes structural deterioration of the concrete such that it cannot be relied on as an effective flow barrier after thawing, see Section 6.5.8.

#### **Impact of concrete barrier degradation**

See Section 6.4.5.

#### **Degradation in sealed hydraulic sections of bentonite**

See Section 6.4.5.

#### **Ice-lens formation**

Extensive periglacial conditions may lead to the formation of ice-lenses in the silo bentonite to such extent that in combination with uncertainties in the sealing properties of the bentonite may lead to increased hydraulic conductivity of the bentonite. Ice-lens formation is further detailed in Section 6.5.8.

In the modelling of the near-field hydrology, a calculation case was set up to evaluate the influence of an ice-lens on the local silo flow. In the model, the affected bentonite barrier was simulated by assigning a ring of high permeability material, surrounding the silo concrete structure (see Abarca et al. 2013). The hydraulic properties of the concrete were assumed to be unaffected. Results show an order of magnitude increase of the flow in the degraded volume, whereas the flow increase in the rest of the silo is moderate. Figure 6-31 shows the velocity field in a plane intersecting the volume affected by the ice lens. As can be seen, water enters and recirculates in the damaged bentonite section. The silo concrete structure limits the amount of water that can penetrate to the waste.

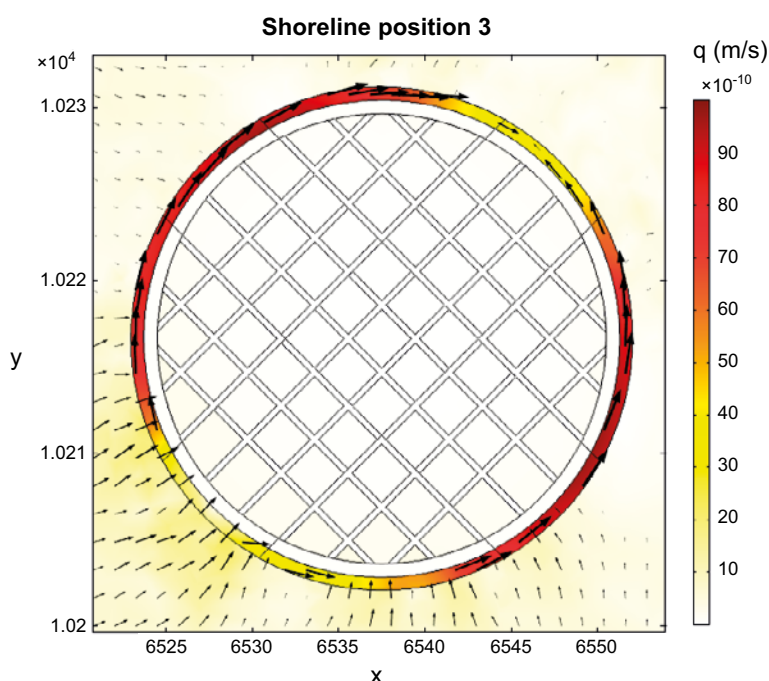
A case analysing the effect of both degraded concrete and bentonite barriers has also been evaluated (Abarca et al. 2013).

### 6.5.6 Geochemical evolution

Generally, water flow and solute transport to and from SFR ceases or is substantially decreased during times of periglacial conditions, except in the presence of taliks (Section 6.5.4). Advective solute transport is limited by the restricted flow during this period. If the water in the fractures is frozen, no exchange between fracture water and the rock matrix by diffusion is expected.

Based on currently available hydrogeochemical information, the groundwater expected to be present around the repository during periods of a periglacial climate domain will be similar to the waters expected during the temperate domain under terrestrial conditions, when the repository is not covered by the sea (see the chosen groundwater composition in Table 6-8). Freeze-out of constituents dissolved in the groundwater can increase the salinity of the liquid phase. Although somewhat dependent of the timing of this period, the effect of such a process is not expected to have any major impact on the salinity distribution in a groundwater that will be substantially diluted by meteoric water at that time. Other processes, e.g. mixing (with older groundwater types), may still be important for the spatial distribution of the groundwater composition. For the long-term evolution of the groundwater composition however, geochemical processes in reactive transport models need to be further considered.

Since the onset of a coming periglacial climate domain is uncertain, two sets of groundwater compositions are proposed, one for a periglacial period within the next 40,000 years, and another for a corresponding period in a more remote time (Table 6-8).



**Figure 6-31.** Darcy velocity (m/s) distribution and vectors in a cross section of the silo traversing the degraded ring of the ice lens ( $z = -105$  m).

### **6.5.7 Chemical evolution of the waste domain**

During times of periglacial conditions, the water in the repository is frozen and all chemical processes (including radionuclide transport) will proceed very slowly, assuming continuous permafrost without taliks. During periods when the water becomes liquid again, the processes continue. As described in Section 6.5.8, the concrete may freeze if the ground temperature at repository depth drops below  $-3^{\circ}\text{C}$ , affecting the structural integrity of the repository. However, the sorption partitioning coefficients ( $K_d$ ) between water and concrete are considered to be unaffected by the concrete structural changes occurring after permafrost. Hence sorption of radionuclides is still accounted for after the permafrost period.

#### ***Water composition***

##### **Groundwater**

Under periglacial conditions, no large changes are expected in the salinity of the groundwater; non-saline groundwater is expected, see Section 6.5.6.

##### **Cement barrier pore water**

The pH of the cement barrier pore water depends on when in time the permafrost occurs. During periods of permafrost at repository depth, all water will be in the solid state.

##### **Waste leachate**

In cement-conditioned waste the leachate is expected to be dominated by the soluble species in the cement, and the pH will be affected by the waste and the amount of cement present, see Table 6-5.

##### **Fluxes of aqueous species**

There will be no fluxes of water when water is in the solid state.

##### **Colloids**

Colloids are not mobile when water is present in the solid state.

##### **Redox**

Redox conditions will not change during permafrost. All relevant processes affecting the redox conditions of the waste domain will cease under such conditions.

##### **Radionuclide speciation**

Speciation of radionuclides is not expected to change during periods of permafrost.

##### **Metal corrosion**

For corrosion to occur liquid water must be present. During periods of permafrost at repository depth, water will be in the solid state, so no or very slow corrosion will take place.

##### **Organic complexing agents and sorption**

During periods of permafrost at repository depth water will be in the solid state, hence chemical equilibria will not be affected. The radionuclides already complexed with organic complexants are expected to still exist as metal-organic complexes. No new complexation between radionuclides and organic complexing agents is taken into account. The radionuclides already sorbed to cementitious materials will remain so. For periods after the permafrost sorption will still take place upon the cementitious materials.

## **Microbiology**

During periods of permafrost, no microbial activity is deemed possible.

## **Gas formation**

The gas formation processes are dependent on liquid water, so gas formation and gas transport are not expected to take place during periods of permafrost at repository depth.

## **6.5.8 Evolution of engineered barriers**

### **Bentonite barriers**

#### **Ice lens formation**

In partially frozen bentonite, non-frozen water will be transported towards the already-frozen parts and contribute to the formation of an ice lens. The process, which ends when there is no longer access to non-frozen water, may lead to increased tensions and displacement of material in connection with the lens. Any possible ice lens formation in the bentonite surrounding the silo will likely be distributed on several lenses. Ice-lens formation is also discussed in Section 6.5.5. With the current knowledge (Birgersson and Andersson 2014), it cannot be excluded that frost heave will occur in the bentonite. This could occur exclusively during periods of permafrost at repository depth.

#### **Consequences of possible ice lens formation**

If the bentonite in the silo is compressed by 1 m, corresponding to approximately 2% of its total height, without water loss, it may lead to a relatively high pressure build-up. However, it has been demonstrated that no detrimental pressure will be caused by ice-lens formation in the silo (Birgersson and Andersson 2014).

The ability of the bentonite surrounding the silo to self-heal after thawing is dependent on how the ice lenses are distributed in the material. As the detailed dynamics of ice lens formation in compacted bentonite is not yet completely clear, this must be considered an open question. The consequences of an unsealed ice lens are discussed in Section 6.5.5.

#### **Freezing of entrapped water**

If a permafrost front passes the repository, a situation could arise where all drainage passages to bentonite components in various parts of the repository (silo, tunnel plugs and backfill) are blocked due to ice-filled fractures in the rock. If the temperature in this case continues to decrease, more water will in turn be converted to ice in the bentonite, which contains substantial amounts of unfrozen water even at temperatures of  $-10\text{ }^{\circ}\text{C}$  or lower. So called frost weathering pressure peaks may then occur. An estimate of the maximum value for such peaks, based on simple elastic mechanical reasoning, has been made. The analysis clearly showed that pressure peaks in a range of a few hundred kPa cannot be excluded (Birgersson and Andersson 2014).

### **Concrete barriers**

#### **Freezing of concrete**

If the temperature at repository depth sinks below  $-3\text{ }^{\circ}\text{C}$ , the concrete may freeze (Thorsell 2013). In concrete with pores completely filled with water, internal freezing may cause penetrating macro-fractures that loosen up the concrete. Loosening of this kind causes such a serious structural degradation of the concrete that it cannot be expected to remain intact after freezing and thawing. The material would disintegrate to such a degree that its function as a diffusion barrier is lost, but it would still function as a sorption barrier and, to a limited extent, as an advective barrier.

## **6.6 Summary of the reference evolution**

This summary gives snapshots of the state of the repository and of its environs at 1,000 years after closure, at the time for the early periglacial conditions around 17,500 AD, at the time for periglacial

conditions around 52,000 AD and at the end of the assessment period. The purpose is to give a summary narrative description of different aspects of the reference evolution and how the details included in the chapter fit into a bigger picture.

### **6.6.1 At 1,000 years after closure**

Two important factors for the reference evolution of the repository and its environs are climate variations and shoreline evolution. 1,000 years after closure the climate will remain temperate and similar to today's climate. With a shore-level change rate of 6 mm/yr the coastline after 1,000 years will be located above to the SFR repository. Some coastal bays have been isolated and transformed to lakes. Shore vegetation will dominate but will be replaced by forest vegetation. Only minor parts of the newly formed land will have the potential for cultivation due to the boulder-rich sediments in the former sea. Food resources and water supply for humans will be similar to present conditions.

Changes in groundwater flow and chemical composition of the groundwater affect the transport of potentially released radionuclides. The groundwater has gradually become more dilute, changing from a composition influenced by the Baltic towards a more fresh composition due to increasing inflow of meteoric waters. The groundwater flow regime at this time is almost parallel to the topographic gradient. In addition, the hydraulic gradient increases, resulting in higher flow rates through the repository. Effects of concrete degradation on the flow through the waste are minor and the sealed hydraulic sections of bentonite, installed at closure to limit vault flow, will still be intact. The discharge areas for the groundwater that has passed through the waste vaults will be at the sea floor (Odén et al. 2014) and the density of exit locations is strongly correlated to outcropping deformation zones.

The chemical evolution of the engineered barriers affects the durability of the barriers as well as sorption and release of radionuclides. The redox potential in the vaults changes from oxidising (due to the initial oxygen content) to highly reducing within 5 years after repository closure and the corrosion of steel-based material processes will keep the system under reducing conditions during the assessment period. Corrosion of metals and microbial processes also generate gas. The possibility cannot be excluded that contaminated water might be expelled from the repository due to gas pressure build-up. Water expulsion could happen within the first few years due to the rapid corrosion of aluminium. If this happens, the expelled water will contain very limited amounts of radionuclides so the impact will be limited. Leaching from cement is expected to keep the pH above 13 in all waste domains where sorption is of importance. Initially the aqueous concentration of complexing agents will be governed by the presence of complexing agents deposited in the waste from the beginning, but the amount will be reduced as they are transported away. With time the ISA concentrations will increase due to alkaline degradation of cellulose. ISA concentrations are expected to reach levels that have an effect on sorption in some compartments in 1BMA, after about 1,000 years. The calculated levels for NTA exceed the levels where sorption is affected (in both 1BMA and the silo) (Keith-Roach et al. 2014).

The bituminised waste deposited in SFR consists mainly of ion-exchange resins and relatively small amounts of evaporator salts. Water uptake and swelling of the bitumen matrix is expected to result in degradation of the bitumen matrix and radionuclide release in the first several hundred to one thousand years after closure (Pettersson and Elert 2001).

Degradation of concrete barriers influences the transport of radionuclides. New fracture networks in the concrete barriers are formed due to volume changes and changes in humidity and temperature during operation and water saturation upon closure of the repository. Corrosion of rebar and the resulting volume increase may cause small fractures in the concrete closest to the rebar, which are then gradually widened. Production of gas, due to corrosion of metals, might exert a pressure on the barriers. In concrete structures, a number of small cracks are sufficient to expel all the gas produced. Interaction between concrete and groundwater leads primarily to the leaching of highly soluble alkali-hydroxides followed by leaching of portlandite. Zones depleted of portlandite may occur along fractures but are not considered to cause any significant changes in hydraulic properties of the barriers during the first 1,000 years. Ettringite will be formed in a thin layer of the concrete barriers near the sulphate containing waste. Formation of ettringite can locally result in cracking and mechanical deterioration of the concrete (Höglund 2014).

## 6.6.2 At the time for possible early periglacial conditions around 17,500 AD

The reference evolution is based on three alternative climate evolutions: the *global warming climate case*, the *early periglacial climate case* and the *extended global warming climate case*. The *early periglacial climate case* describes an evolution where an early (around 17,500 to 20,500 AD) occurrence of cold climate conditions is considered. The climate conditions at this time are cold enough for permafrost development in Forsmark. It is however unlikely to get ground temperatures at repository depth of  $-3^{\circ}\text{C}$  or less, relevant for freezing of concrete repository structure.

The reference evolution is the same in both cases until the first occurrence of cold climate. The transition from temperate climate domain to periglacial climate domain is described in the following in terms of conditions prior to the transition (temperate climate domain) and after the transition (periglacial climate domain).

At the time of the transition to periglacial climate domain, the shoreline is far away from the repository and the landscape consists of terrestrial ecosystems, mainly forests and mires. A number of lakes have been isolated from the sea, infilled and transformed into mires. Larger areas in the former central Öregrundsgrepen have fine-grained sediments that can be cultivated and previous lakes/mires may also be cultivated. Also, the availability of freshwater for human supply is expected to gradually increase. When the temperatures drop and the climate changes to a periglacial domain, the vegetation period becomes short and the terrestrial vegetation consists of sedges, herbs and shrubs. Nevertheless, primary production may be high in some environments, e.g. in shallow lakes (Andersson 2010). Taliks, which are unfrozen throughout the entire permafrost layer, are the only spots in the periglacial landscape where radionuclides potentially released from the repository can be transported up to the biosphere. Given that human settlement and land use often are located near lakes and streams, humans can potentially be exposed to radionuclides at taliks during periods of periglacial conditions.

During the temperate climate domain prior to the transition to periglacial climate domain, the groundwater flow is essentially at steady-state and parallel to the topography. Exit locations for particles from SFR 1 and SFR 3 are driven towards the same depression in topography, see Figure 6-19. However, owing to its deeper location, a small number of particles from SFR 3 discharge into lakes and streams further away from the repository. When the temperature decreases to a point where the geosphere freezes, the water flow and solute transport to and from SFR ceases or is substantially decreased. Hence advective transport is limited and if the water in the fractures is frozen, no exchange between fracture water and the rock matrix by diffusion is expected. The most relevant scenarios for the SFR area during periods of periglacial climate conditions, predict significantly lower total flow through the waste vaults, longer path lengths and travel times and higher flow-related transport resistance values compared with the values under temperate conditions. However, the results are dependent on the extent and number of taliks in the flow domain. Most exit locations are found in the lake taliks and more than 99% of the particles discharge in the taliks to the northeast, see Figure 6-12. Simulations of the flow through the repository during permafrost show that the flow is reduced by approximately 80%.

The chemical conditions described for 1,000 years after closure (summarised in Section 6.6.1) are applicable also at this time. The groundwater can be considered as fresh, reducing conditions prevail in the repository and the pH is approximately 12.5 in all waste domains, except for 1BLA. In 1BLA, the pH will gradually decrease, due to the lack of concrete structures, and at this time it has reached the pH of the intruding groundwater. For 2–5BLA the pH evolution is assumed to follow the 1BLA evolution. It cannot be ruled out that microbial activity can be large in the BLA waste vaults when the pH has dropped to groundwater levels. At this time all cellulose is expected to be degraded. If the water in the repository is frozen all chemical and transport processes will proceed very slowly and when the water becomes liquid again, the processes will continue.

The montmorillonite is gradually transformed in contact with water with a high pH and at this time more than one third of the total quantity of montmorillonite in the bentonite has been transformed to other minerals. The montmorillonite is replaced by calcium-silicate minerals, zeolites and new clays. These minerals have different properties from the original montmorillonite, including poorer swelling properties and a higher molar volume. The possibility cannot be ruled out that the extent of transformation is so great that the bentonite barrier loses its swelling capacity with time, which could entail a higher risk of fracturing and higher hydraulic conductivity. When it comes to sorption,

it is based on the presence of a sufficient fraction of bentonite for all time scales, and the zeolites that are formed, with generally high sorption of cations, should be as good or better sorbents than the original minerals. If permafrost reaches the repository, an ice lens may form in the silo bentonite. Bentonite will gradually be displaced as the lens grows. After thawing, when the ice lens melts and the bentonite swells, the sealing properties of the bentonite are expected to be locally degraded. Simulations show an order of magnitude increase of the flow in the degraded volume, but the silo structure will limit the amount of water that can penetrate to the waste, since the concrete barriers are not expected to be degraded during this early period of permafrost. Another possible process in the bentonite during permafrost is freezing of trapped water which may cause a considerable pressure increase.

Fracturing of concrete packaging and cement matrices, might occur due to processes such as carbonatisation and ettringite formation in pores when sulphate from degraded ion-exchange resins reacts with cement minerals. Complete degradation of ion-exchange resins could lead to such extensive ettringite formation that the concrete packaging bursts. However, the chemical conditions in SFR do not favour degradation of the ion-exchange resins.

Portlandite in the concrete barriers is being leached out, keeping the pH high in the pore water. Although the alteration of the concrete is ongoing and the porosity varies during the studied period, the concrete barriers can still be regarded as concrete material. As the extension of the portlandite-depleted zone at fracture surfaces in the concrete increases, the zone could eventually propagate through the whole concrete barrier. This can lead to an increased hydraulic conductivity of the fracture which could be considered as an effective widening of the fracture and as a result give a more localised flow through the concrete barrier. At this time the bulk concrete in the most exposed concrete structures is depleted of portlandite and an incongruent leaching of calcium silicate hydrate phases has started. In the *early periglacial climate case* the temperature at repository depth is not expected to be low enough for concrete to freeze ( $-3^{\circ}\text{C}$ ).

### **6.6.3 At the time for periglacial conditions around 52,000 AD**

In both the global warming climate case and the early periglacial climate case, a periglacial period occurs at about 52,000 AD. The difference from the early periglacial period briefly described in Section 6.6.2 is that ground temperatures below  $-3^{\circ}\text{C}$  at repository depth cannot be ruled out. These temperatures lead to freezing of cement which, in turn, will result in penetrating macro-cracks that loosen up the concrete. Loosening of this kind cause such a serious structural deterioration of the concrete that it cannot be relied on to remain intact after freezing and thawing. The material no longer limits advective flow, although it continues to act as a sorption barrier.

### **6.6.4 At the end of the assessment period**

At the end of the assessment period a succession of periods of temperate and periglacial climate domains have passed. The biosphere and geosphere characteristics are similar to those at the time for the early periglacial climate conditions (Section 6.6.2). The groundwater has successively become more and more dilute. All steel contained in the vaults should be exhausted but the system will still possess a high reducing capacity due to the magnetite previously formed as a steel corrosion product. The pH of the different waste domains is determined by the portlandite equilibrium and is still at approximately 12.5 except for 1BLA and 1BMA. In 1BLA the pH is the same as the pH of the intruding groundwater and the pH in 1BMA is 11.5. The pH evolution in Figure 6-27 indicates the pH at a specific point in a 2BMA concrete barrier and it thus differs from the pH evolution shown in Table 6-5, where the waste domain is represented as a stirred tank in the pH calculations. Only a small portion of the montmorillonite in the bentonite barriers remains. Freezing and thawing has degraded the concrete barriers completely.





## 7 Selection of scenarios

### 7.1 Introduction

The safety assessment scenarios for evaluation of the long-term safety of the SFR repository are selected and described in this chapter. The long-term safety of the repository is evaluated using radionuclide transport calculations with radiological risk as the primary endpoint. SSM's regulations SSMFS 2008:21 require that scenarios are used to describe future potential evolutions of the repository and that among these there should be a main scenario that takes into account the most likely changes within the repository and its environs. The general advice to SSMFS 2008:21 describe three different categories of scenarios:

- main scenario,
- less probable scenarios,
- other scenarios or residual scenarios.

The main scenario is based on the probable evolution of external conditions, and realistic, or, where justified, pessimistic assumptions with respect to the internal conditions, as described in the reference evolution (Chapter 6). It is also based on the initial conditions specified in Chapter 4. In summary, the description of the main scenario comprise descriptions of external conditions, the evolution of the geosphere, the repository and the surface system as well as the data needed and the approach chosen for radionuclide transport modelling. The main scenario is complemented by a number of less probable and residual scenarios as further described in Section 7.3.

The radionuclide transport calculation cases that have been identified to analyse the scenarios are described in Chapter 8. The radiological consequences of the different scenarios are presented and discussed in Chapters 9 and 10.

### 7.2 Regulatory requirements – Scenario selection

SSM's regulations SSMFS 2008:21 require that scenarios should be used to describe future potential evolutions of the repository and that among these there should be a main scenario that takes into account the most likely changes within the repository and its environs.

The general advice to SSMFS 2008:37 defines a scenario as:

*A description of the potential evolution of the repository given an initial state and specified conditions in the environment and their development.*

The general advice to SSMFS 2008:21 states the following:

*A **scenario** in the safety analysis comprises a description of how a given combination of external and internal conditions affects repository performance.*

Regarding the selection of scenarios, the general advice to SSMFS 2008:37 states the following:

*An assessment of the protective capability of the repository and the environmental consequences should be based on a set of scenarios that together illustrate the most important courses of development of the repository, its surroundings and the biosphere.*

#### **Dealing with climate evolution**

*Taking into consideration the great uncertainties associated with the assumptions concerning climate evolution in a remote future and to facilitate interpretation of the risk to be calculated, the risk analysis should be simplified to include a few possible climate evolutions.*

*A realistic set of biosphere conditions should be associated with each climate evolution. The different climate evolutions should be selected so that they together illustrate the most important and reasonably foreseeable sequences of future climate states and their impact on the protective capability of the repository and the environmental consequences."*

The general advice to SSMFS 2008:21 describes three types of scenarios: the main scenario, less probable scenarios, and residual scenarios.

For these categories the general advice to SSMFS 2008:21 states the following:

*The **main scenario** should be based on the probable evolution of external conditions and realistic, or where justified, conservative assumptions with respect to the internal conditions. It should comprise future external events which have a significant probability of occurrence or which cannot be shown to have a low probability of occurrence during the period of time covered in the safety analysis. Furthermore, it should as far as possible be based on credible assumptions with respect to internal conditions, including substantiated assumptions concerning the occurrence of manufacturing defects and other imperfections, and which allow for an analysis of the repository barrier performance (for example, it is insufficient to always base the analysis on leaktight waste containers over an extended period of time, even if this can be shown to be the most probable case). The main scenario should be used as the starting point when analysing the impact of uncertainties (see below), which means that the analysis of the main scenario also includes a number of calculation cases.*

***Less probable scenarios** should be prepared for the evaluation of scenario uncertainty (see also below). This includes variations of the main scenario with alternative sequences of events and periods of time as well as scenarios that take into account the impact of future human activities, such as damage inflicted on barriers. (Detriment to humans intruding into the repository is illustrated by residual scenarios; see below.) An analysis of less probable scenarios should include analyses of uncertainties that are not evaluated within the framework of the main scenario.*

***Residual scenarios** should include sequences of events and conditions that are selected and studied independently of probabilities in order to, inter alia, illustrate the significance of individual barriers and barrier functions. The residual scenarios should also include cases to illustrate detriment to humans intruding into the repository as well as cases to illustrate the consequences of an unclosed repository that is not monitored.*

The general advice to SSMFS 2008:37 states:

*A number of future scenarios for inadvertent human impact on the repository should be presented. The scenarios should include a case of direct intrusion in connection with drilling in the repository and some examples of other activities that indirectly lead to a deterioration in the protective capability of the repository, for example by changing the hydrological conditions or groundwater chemistry in the repository or its surroundings. The selection of intrusion scenarios should be based on present living habits and technical prerequisites and take into consideration the repository's properties.*

*The consequences of the disturbance for the repository's protective capability should be illustrated by calculations of the doses for individuals in the most exposed group and be reported separately from the risk analysis for the undisturbed repository. The results should be used to illustrate conceivable countermeasures and to provide a basis for the application of best available technique (see the advice on optimisation and best available technique).*

The general advice to SSMFS 2008:37 also mentions that in respect of:

*Special scenarios .... an analysis of a conceivable loss during the first thousand years after closure of one or more barrier functions of key importance for the protective capability should be presented separately from the risk analysis. The intention of this analysis should be to clarify how the different barriers contribute to the protective capability of the repository.*

## **7.3 Method for scenario selection**

### **7.3.1 The main scenario**

The main scenario is based on the initial state and the processes that are found to be of importance for the long-term evolution and safety of the repository as described in Chapter 6. The reference evolution, as presented in Chapter 6, is defined as a range of possible future evolutions of the repository system, while the main scenario is more specific in order to permit the evaluation of the radiological risk. The main scenario consists of two variants, based on the *global warming* and the *early periglacial variants* of the reference evolution (see Chapter 6). The main scenario is described in Section 7.4.

### 7.3.2 Less probable scenarios

Less probable scenarios of relevance for assessing the long-term safety of the repository are arrived at by considering the safety functions presented in Table 5-3. Scenarios are selected by going through possible routes to violation of each safety function, i.e. by examining the uncertainties in initial state, internal processes and external conditions and assessing if there is a possibility that the status of the safety function deviates from that in the main scenario in such a way that a lower degree of safety is indicated. Thereby an alternative evolution of the repository system deemed to be of importance for the long-term function of the repository is identified. The probability of each scenario is assessed based on the scenario-generating uncertainty in the initial state, internal processes and/or external conditions. Less probable scenarios are selected in Section 7.5 and described in Section 7.6.

### 7.3.3 Residual scenarios

A set of residual scenarios is also defined. These consist of scenarios chosen in order to illustrate:

- The significance of individual barriers and barrier functions.
- Damage to humans intruding into the repository and the consequences of an unclosed repository.
- Consequences of external conditions within the range defined by the SR-PSU climate cases that are not included in the main scenario.

The residual scenarios are analysed regardless of their probability. The residual scenarios are described in Section 7.7.

### 7.3.4 Combinations of scenarios

For the scenario selection to be comprehensive, combinations of the scenarios and variants must be considered. This is done when all the scenarios have been selected. The number of possible combinations could become large, even considering that mutually exclusive scenarios should not be combined, and a practical approach for handling this situation has to be adopted. The evaluation of combinations of scenarios is described in Section 7.8.

## 7.4 Main scenario

The main scenario is defined based on the *global warming* and the *early periglacial* variants of the reference evolution, as described in Section 7.3.1. The description below of the main scenario begins with a description of external conditions, i.e. climate evolution and shoreline displacement. This is followed by descriptions of the evolution of the geosphere, the repository and the surface system, including descriptions of the approach chosen for radionuclide transport modelling and the data needed in the modelling. The exposure of humans and non-human biota in the main scenario is also described. Finally, the assumptions regarding the status of the safety functions in the main scenario are given.

### 7.4.1 External conditions

Based on the reference evolution, the main scenario consists of a climate evolution representing prolonged interglacial conditions, as described in Section 6.2. Two variants of the main scenario are defined based on two of the climate cases included in the reference evolution:

- The global warming climate case.
- The early periglacial climate case.

The *extended global warming climate case*, included in the reference evolution, is not included in the main scenario. This climate case is included in the range of future evolutions in SR-PSU in order to analyse the possible impact on repository safety of groundwater recharge by meteoric water over prolonged periods of time affecting groundwater geochemistry (**Climate report** Section 1.2). Since no negative such effects were identified in the reference evolution, and in particular since dispersion of bentonite clay during extended periods of meteoric groundwater recharge has been judged as not posing a problem for the SFR repository (Sections 6.3.8 and 6.4.8), this evolution is not included in the main scenario.

The *global warming climate case* is based on the assumption that the combination of anthropogenic greenhouse gas emissions and the characteristics of the known future variations in incoming solar radiation (insolation) will result in a warmer climate and a prolonged interglacial period, see Section 6.2. The *early periglacial climate case* describes a faster decrease in the anthropogenic influence on global climate and, therefore, an earlier onset of cold climate conditions in Forsmark, see Section 6.2. In the climate cases, climate-related conditions in Forsmark are represented by a sequence of so-called climate domains, as described in Section 6.2. The evolution of climate and climate-related issues in the two variants of the main scenario are described in the following.

### The global warming climate variant of the main scenario

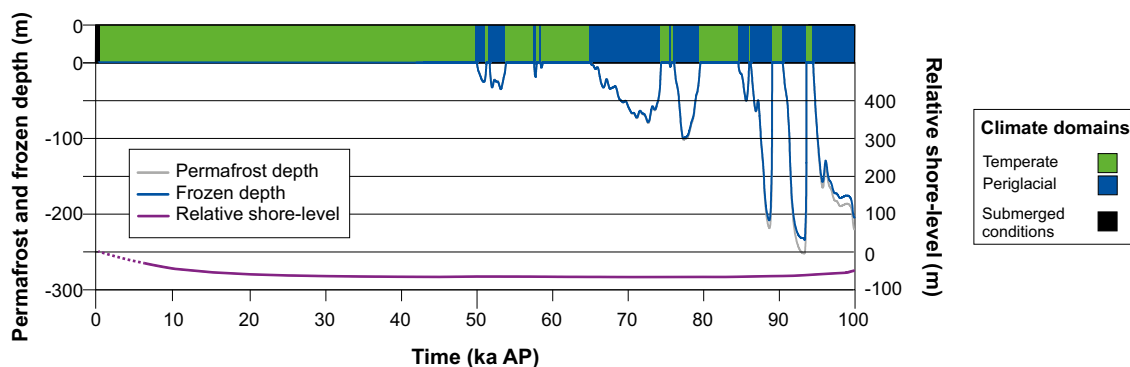
The evolution of climate and climate-related conditions in Forsmark in the *global warming variant* of the main scenario is defined by the evolution in the *global warming climate case*, displayed in Figure 7-1. The *global warming climate case* describes a situation combining future low-amplitude variations in insolation with moderate carbon emissions in the current and next century, followed by a slow decrease in atmospheric CO<sub>2</sub> concentration. The first occurrence of the periglacial climate domain occurs at 52,000 AD. At this time, it cannot, under pessimistic assumptions, be excluded that bedrock temperatures at repository depth might decrease to  $-3^{\circ}\text{C}$  or lower, i.e. the temperature relevant for freezing of concrete structures (Section 6.5.8). This climate case thus comprises an evolution initially dominated by moderate global warming, followed by a period dominated by cold climate conditions.

### The early periglacial variant of the main scenario

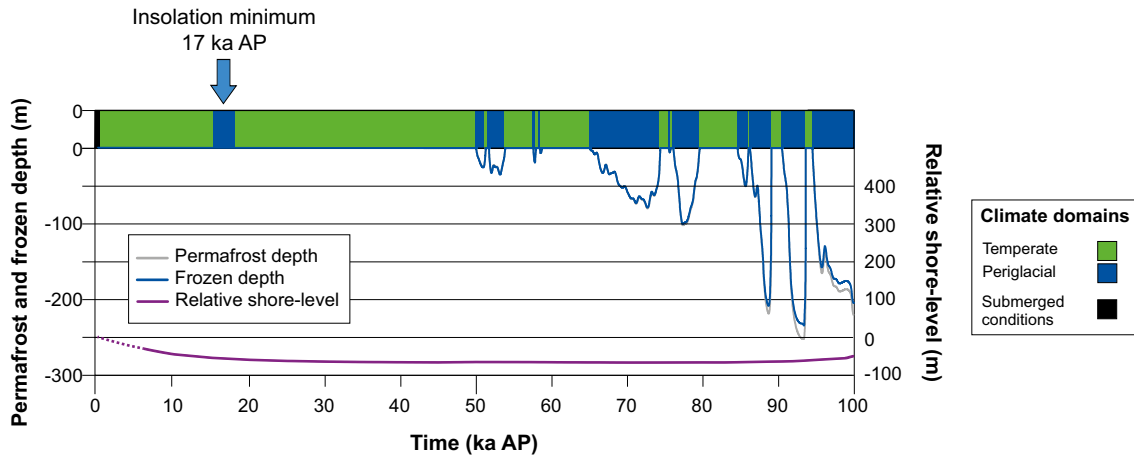
The evolution of climate and climate-related conditions in Forsmark in the *early periglacial variant* of the main scenario is defined by the evolution in the *early periglacial climate case*, displayed in Figure 7-2. The evolution represents a similar development as in the *global warming variant*, but with a faster decrease in atmospheric CO<sub>2</sub> concentration resulting in a period of periglacial conditions with permafrost in Forsmark during the period of minimum insolation around 17,500 to 20,500 AD. During this period, frozen ground cannot be excluded at repository depth (60 to 140 m), see Section 6.2.3. However, it is very unlikely that the bedrock temperature at repository depth during this period of periglacial climate domain would decrease to  $-3^{\circ}\text{C}$  or lower, i.e. the temperature relevant for freezing of concrete repository structures (Section 6.5.8). After this period, the Forsmark climate returns to the temperate climate domain and the succession of climate domains is identical to that in the *global warming climate case*.

### Shoreline displacement

Shoreline displacement controls groundwater flows and retention times in the rock, which in turn control the velocity at which radionuclides are transported from the repository to the discharge locations in the surface systems. The SFR repository covered by 60–120 metres of bedrock is currently situated below the Baltic Sea. The location of the repository in relation to the shoreline will in the future vary over time due to isostatic and eustatic (sea level) variations. At present, the resulting shore-level change is circa 6 mm/yr vertically at Forsmark with the land emerging from the sea (Section 6.2.2).



**Figure 7-1.** Evolution of climate-related conditions at Forsmark as a time series of climate domains and submerged periods in the global warming variant of the main scenario. Time is given in relation to the present day, where 0 ka AP corresponds to 2000 AD. The figure is identical to Figure 6-1.



**Figure 7-2.** Evolution of climate and climate-related conditions at Forsmark as a time series of climate domains and submerged periods in the early periglacial variant of the main scenario. The corresponding evolution of permafrost and frozen depth, as well as relative shore-level, is shown in the lower panel. Note that the permafrost and frozen ground evolution is not shown for the period 0 to 50 ka AP. Permafrost and frozen ground can however not be excluded to a depth of about 150 m for the periglacial period from 15.5 to 18.5 ka AP (see Section 6.2.3). Time is given in relation to the present day, where 0 ka AP corresponds to 2000 AD. The figure is identical to Figure 6-2.

The shore-level evolution is identical in the two variants of the main scenario (see Figure 7-1 and Figure 7-2). The duration of the transition from present-day conditions to terrestrial conditions above SFR is circa 1,000 years (Section 6.2.2). Just as in the past, this future shore-level evolution results in a dynamical evolution of the landscape, with the formation of new land areas affecting geochemical and hydrological conditions, which in turn affect transport properties and velocities.

### Radionuclide transport modelling

The succession of climate domains in the two variants of the main scenario, presented in Figure 7-1 and Figure 7-2, as well as shoreline position, are used in modelling activities, such as the hydrogeological estimation of water flows (Section 7.4.2) and simulation of the development of the surface systems (Section 7.4.5) that are used as input to the radionuclide transport calculations.

### 7.4.2 Geosphere

The consequence of shoreline displacement is that the hydraulic gradient in the area increases and the flow direction goes from being upward to being more horizontal and parallel to the topographical gradient. After the land over the repository has risen above sea level, the groundwater flow becomes less influenced by the landscape development and is expected to reach steady state. Constant flow rates in the region of the repository can be expected from around 5000 AD and for as long as temperate conditions prevail. The change of groundwater flow with time in the bedrock results in changes in the flow through the waste vaults, see Figure 7-7.

Under periglacial conditions, advective transport is restricted due to the low permeability of frozen ground. However, unfrozen taliks in the otherwise frozen landscape may occur under lakes, streams and mires. All lakes in the Forsmark area are expected to be infilled and transformed into mires at the time of occurrence of periglacial conditions in the main scenario. Taliks may form in these mires in periods of shallow permafrost. The permafrost is expected to be deeper during later periods of periglacial conditions after 52,000 AD due to colder climate conditions, than during the first period of periglacial conditions in the main scenario about 17,500 AD to 20,500 AD (Section 6.2.3). This first period of periglacial conditions in the *early periglacial variant* of the main scenario is therefore chosen for the evaluation of potential doses to humans and non-human biota during a period of discontinuous permafrost with taliks. The radionuclide inventory is larger at this time than during the remaining periods of periglacial conditions in the main scenario. For the later periods of periglacial conditions continuous permafrost without taliks is assumed.

Discharge locations, i.e. where groundwater from the repository may reach the biosphere, are determined by modelling of groundwater passing through the waste vaults. The discharge areas are strongly correlated with the locations of the deformation zones. As the shoreline moves, the discharge areas change together with the lengths and travel times of the discharged water pathways (Figure 7-3). However, the vast majority of the discharge occurs in the same discharge area, a small area in the direct vicinity downstream of the repository. The changes in flow-related transport resistance, travel time and path length at different future times are shown in Figure 7-4, Figure 7-5 and Figure 7-6.

The geochemical conditions are closely related to the hydrological conditions, because water flow is of great importance in influencing groundwater composition. The groundwater is initially brackish/saline (Table 4-14 and 6-1), but becomes increasingly diluted after the shoreline has passed the discharge area. When the area above the repository is above sea level, meteoric water is expected to infiltrate. The expected groundwater composition under periglacial conditions differs only slightly from the expected composition under temperate conditions, hence the two groundwater compositions given in Table 6-8 (for climate domains persisting for shorter and longer periods than 40,000 years) are valid for both temperate and periglacial domains. In the main scenario, reducing conditions in the geosphere will prevail for the entire assessment period.

The mechanical conditions in the bedrock around SFR are not expected to change significantly during the assessment period. The rock stresses will only change to a small extent, but not in such a way that the conditions for the repository are altered (Sections 6.3.3 and 6.4.3). There is a possibility of an earthquake large enough to lead to damage during the assessment period, but the probability for this is low. Hence, such an earthquake is handled in a less probable scenario, see Section 7.6.5.

### **Radionuclide transport modelling**

The main processes related to radionuclide transport identified in the geosphere are radioactive decay and in-growth, advection, dispersion, rock-matrix diffusion, and sorption (**Geosphere process report** Chapter 6). Modelling of these processes is briefly described below.

**Radioactive decay and in-growth:** radioactive decay and in-growth were included in the modelling by means of rates for decay and in-growth proportional to the inventory of the corresponding radionuclide or its parent, respectively, and parameterised with decay constants and branching ratios.

**Advection:** advection in the geosphere is driven by the flow of groundwater in host rock fractures.

**Dispersion:** dispersion along the individual flow paths due to velocity variations was modelled by means of a dispersion term parameterised with the dimensionless Peclet number that quantifies the ratio between advective and dispersive transport.

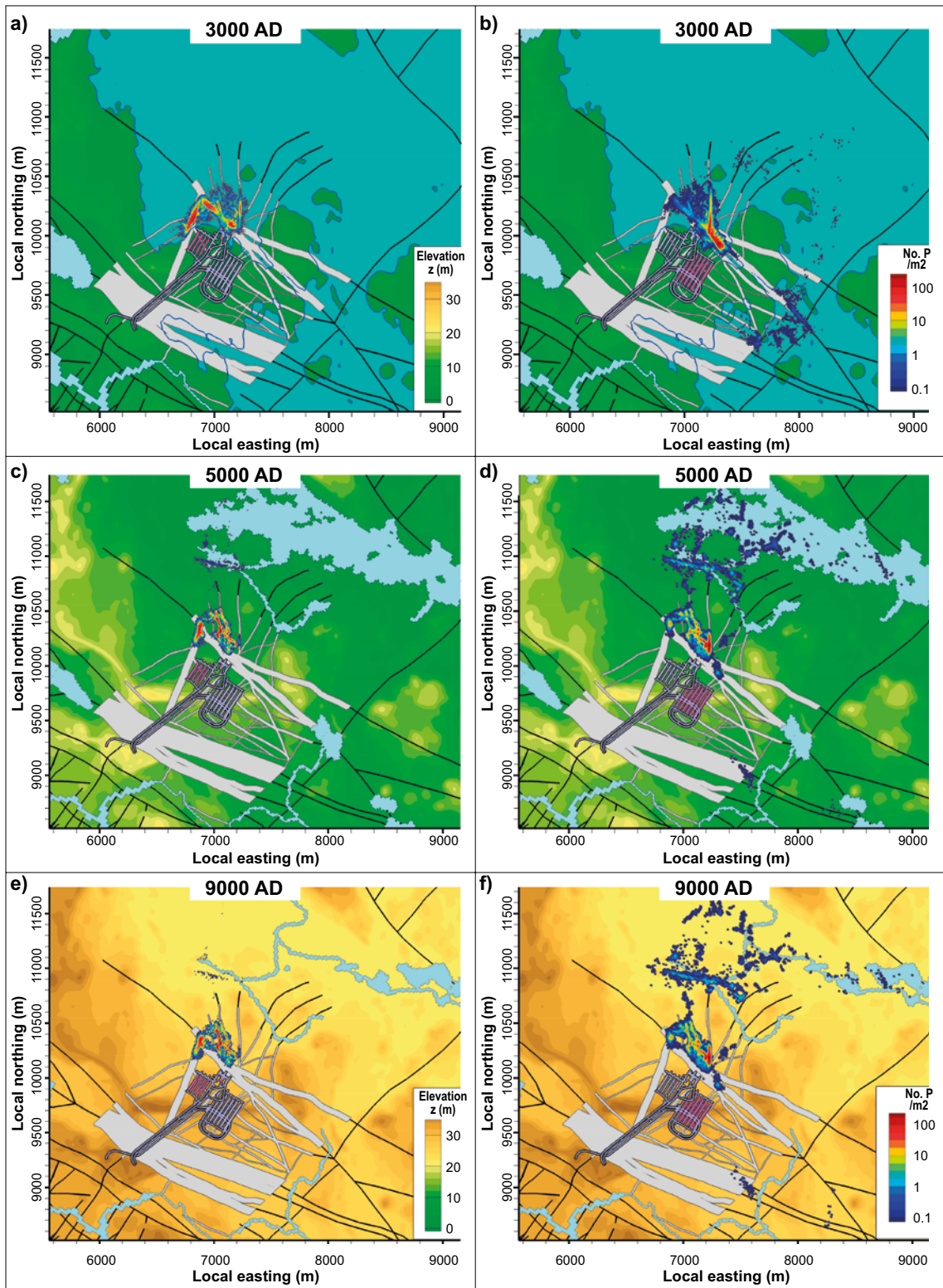
**Sorption:** sorption in the rock matrix is of importance for radionuclide transport. Sorption on the rock matrix was modelled using a linear equilibrium approach, based on element specific  $K_d$  values.

**Rock-matrix diffusion:** rock-matrix diffusion is the process by which solutes enter and leave the rock-matrix porosity under the influence of a concentration gradient driving force. It is described as a random walk process whereby solute moves from a region of high concentration to a region of low concentration (i.e. Fickian diffusion). The effective diffusivity of a solute in the rock matrix is approximated as the product of the geometric formation factor and the diffusivity of the solute in water at infinite dilution.

### **Data**

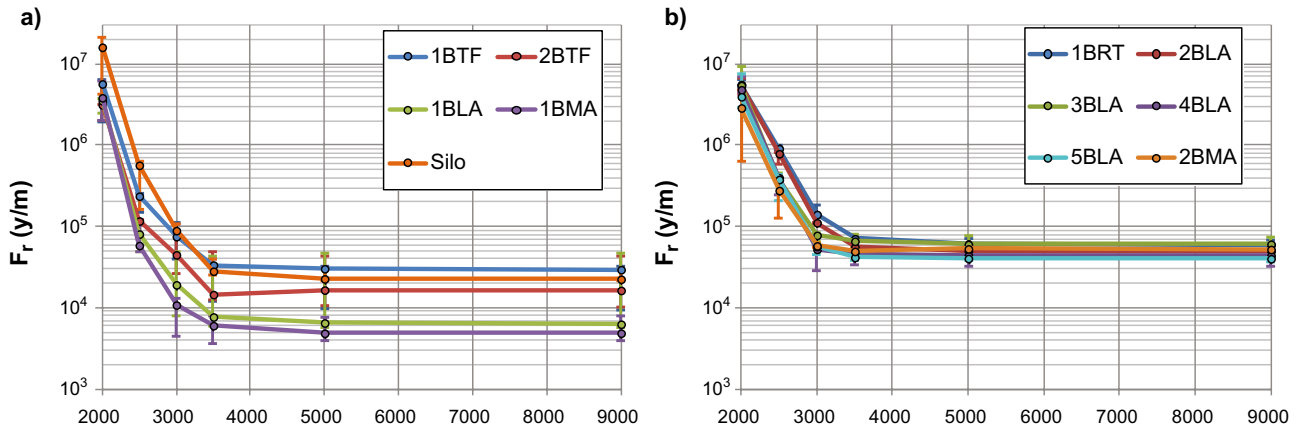
Radionuclides in the groundwater are transported in the geosphere by advection, whereas retention of the radionuclides is controlled by matrix diffusion and sorption in the rock matrix.

Median values from the regional hydrogeological calculations for three bedrock cases (different parametrisations of the bedrock) of flow-related transport resistance, travel time and path length for different times are shown in Figure 7-4 to Figure 7-6. These cases were selected, based on calculated flows through the waste vaults, to be a representative low-flow bedrock case, an intermediate-flow

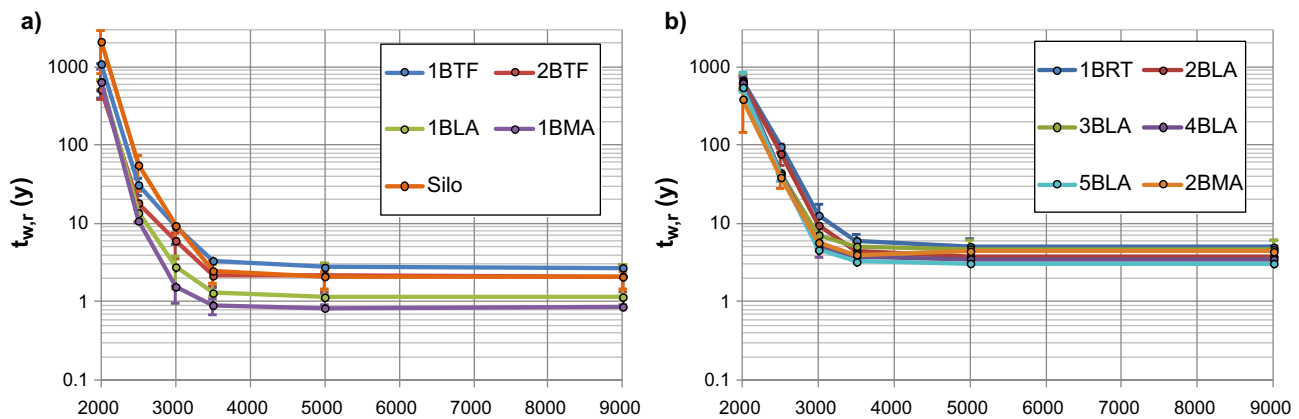


**Figure 7-3.** Discharge locations from SFR 1 (pink shade; left) and from SFR 3 (pink shade; right) illustrated by particle density at the surface. Based on 1,000,000 particles released at repository depth. The black lines represent deformation zones. The white areas also represent deformation zones, but zones closer to the SFR repository where the width of a white area indicates the zone thickness at ground surface. Corresponds to Figures 6-6 and 6-19.

case (bedrock case 1) and a high-flow case (bedrock case 11) under temperate conditions (Odén et al. 2014). Results from the intermediate-flow bedrock case were selected to be used in the radionuclide transport calculations for periods with temperate conditions in the main scenario. The effect of high flow in the bedrock is analysed in a less probable scenario (Section 7.6.2). The results used in the probabilistic radionuclide transport calculations were advective travel times and flow-related transport resistance<sup>7</sup> values selected in pairs from the same realisations/particle tracks. These pairs of input data are available for 2000 AD, 2500 AD, 3000 AD, 3500 AD, 5000 AD and 9000 AD and are given in the **Input data report**, Section AMF number 11.



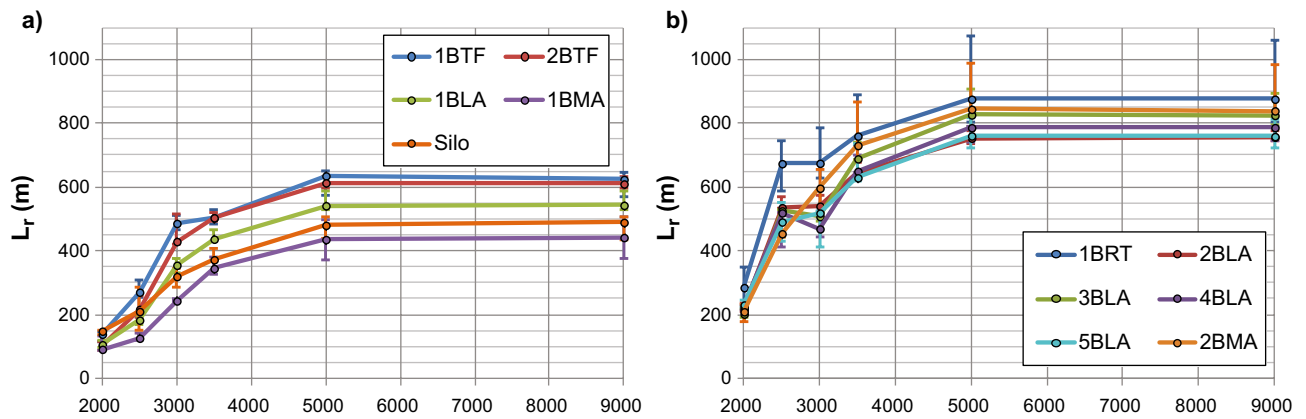
**Figure 7-4.** Median values of the flow-related transport resistances ( $F_r$ ) for different waste vaults as a function of time (given in years AD on the x-axis): a) in SFR 1 and b) in SFR 3. The bars indicate the difference between the three bedrock cases selected to be representative for low, intermediate and high flow (Odén et al. 2014).



**Figure 7-5.** Median values of the advective travel times ( $t_{w,r}$ ) for different waste vaults as a function of time (given in years AD on the x-axis): a) in SFR 1 and b) in SFR 3. The bars indicate the difference between the three bedrock cases selected to be representative for low, intermediate and high flow (Odén et al. 2014).

<sup>7</sup> The flow related transport resistance,  $F$ , is used to calculate the needed input data flow-wetted surface area,  $a_w$ , by dividing it by the advective travel time,  $t_w$  ( $a_w = F/t_w$ ).





**Figure 7-6.** Median values of the path lengths ( $L_r$ ) for different waste vaults as a function of time (given in years AD on the x-axis): a) in SFR 1 and b) in SFR 3. The bars indicate the difference between the three bedrock cases selected to be representative for low, intermediate and high flow (Odén et al. 2014).

For periods of periglacial conditions, three main hydrogeological calculations were identified from the set of performed variants found in Odén et al. (2014). These include a case with discontinuous, shallow permafrost and taliks, a case with shallow permafrost but only larger water bodies and lakes unfrozen, and, thirdly a case with permafrost to SFR 1 depth (about 60 m) and only larger lakes unfrozen. The first of these calculations gives similar results, in terms of water flow, as the bedrock case 1 for 9000 AD described above (Odén et al. 2014). Therefore, flow-related parameters from 9000 AD for temperate conditions were used for modelling the first periglacial period of the *early periglacial variant* of the main scenario (i.e. between 17,500 AD and 20,500 AD), when permafrost is assumed to be discontinuous and shallow. However, during this periglacial period the flow was redirected to the talik locations simulated in the case with discontinuous, shallow permafrost. During the periglacial periods of the *global warming variant* of the main scenario (see Figure 7-1), a continuously frozen landscape over the entire model domain was assumed, and hence no potential for transport from repository depth to the surface within the assessed areas.

Partitioning coefficients for sorption,  $K_d$  values, for the rock matrix are presented as log-normal distributions in Table 8-7 in the **Data report** for different groundwater compositions. Three groundwater compositions were selected to be representative for the main scenario; temperate brackish/saline, temperate/periglacial and late temperate/periglacial. In general, the lowest  $K_d$  value for each element was (pessimistically) selected to be used in the radionuclide transport calculations during the whole assessment period except for some radionuclides that are sensitive to pH and redox. The  $K_d$  values valid for environments with pH less than 10 were then selected (this concerns Np(IV), Pu(III/IV), Sn(IV) and U(IV)). For those elements where  $K_d$  values differ depending on their oxidation states, the  $K_d$  values for reducing conditions were applied (e.g. Np(IV) and Tc(IV)), since reducing conditions is expected to prevail in the main scenario. The  $K_d$  value for Po was assigned to be the same as for Pb.

Effective diffusivities,  $D_e$ , for all radionuclides in the rock matrix were described by a log-normal distribution with a geometrical mean of  $3.2 \cdot 10^{-14}$  m<sup>2</sup>/s. The Peclet number was assigned to be 10, the rock porosity 0.0018, the density 2,700 kg/m<sup>3</sup> and the matrix penetration depth (half the distance between fractures) 1.4 m.

### 7.4.3 Repository

The chemistry of the repository is affected by water flow through the repository, which is in turn affected by shoreline displacement and permafrost development. Several internal processes influence the evolution of the repository resulting in successive degradation of the barriers. The reference evolutions for the hydrological conditions, the wastes and the engineered barriers are described in detail in Sections 6.3.5, 6.3.7, 6.3.8, 6.4.5, 6.4.7, 6.4.8, 6.5.5, 6.5.7 and 6.5.8. Here a brief description is given of the repository evolution in the main scenario, divided into hydrological conditions and waste packages and engineered barriers.

### Hydrological conditions

Shoreline displacement and permafrost development have a great influence on the water flow in the repository. The magnitude, direction and distribution of the water flow between the different parts of the waste vaults are also dependent on the hydraulic properties of each component. The water flow influences concrete degradation and transport of radionuclides and other substances.

The flow in the repository follows the same pattern as that described for the geosphere. Once the shoreline has passed over the repository, the flow gradually changes direction from vertically upward to horizontal. The hydraulic gradient increases, which leads to increased flow rates through the repository, see Figure 7-7. When land conditions have been established above the repository, the flow direction and the hydraulic gradient stabilise and can be assumed to be constant for as long as temperate conditions prevail.

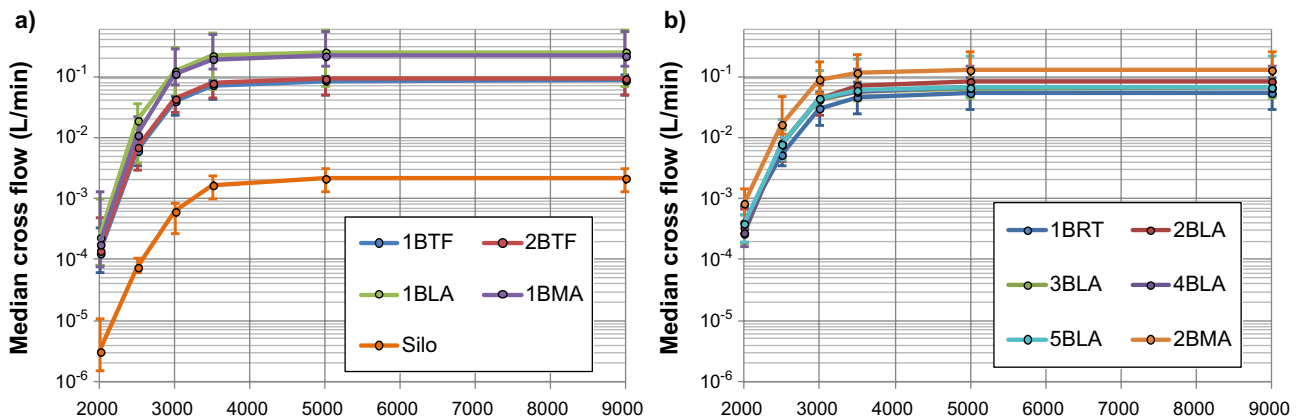
Degradation affects the hydraulic properties of the materials inside the vaults and hence the distribution of the water flows. As described in Sections 6.3.5, 6.4.5 and 6.5.5, several calculation cases of the repository hydrogeology have been performed (Abarca et al. 2013, 2014) to illustrate this, see further the Section on Data below. The materials in the repository are described as homogenous porous media and fractures are implicitly included by the choice of hydraulic conductivities. The boundary conditions for the calculations representative of the main scenario were extracted from the intermediate-flow bedrock case which was chosen for the main scenario as described in Section 7.4.2.

### Waste packages and engineered barriers

The durability of the waste packages and engineered barriers in the repository is affected by external conditions and internal processes as described in Sections 6.3.7, 6.3.8, 6.4.7, 6.4.8, 6.5.7 and 6.5.8. A simplified description of the evolution of the waste packages and engineered barriers and how it is implemented in the main scenario to handle radionuclide transport in the near-field is given here.

### Degradation of cementitious materials

The degradation of cementitious materials in the waste packages and engineered barriers resulting from all external conditions and internal processes can be divided into two main categories; physical/mechanical degradation and chemical degradation.



**Figure 7-7.** Median values of the cross flows through each waste vault as a function of time (given in years AD on the x-axis): a) in SFR 1 and b) in SFR 3. Dots indicate median values over all 17 bedrock cases, whereas the bars indicate the variability (Odén et al. 2014).

The physical/mechanical degradation of cementitious materials includes fracturing and other changes of the pore structure, caused by, for example, degradation of reinforcement, gas formation, leaching and formation of new phases. Freezing is another process that may lead to fracturing of cementitious materials. However, the climatic conditions in both variants of the main scenario are so that freezing of concrete (bedrock temperature of less than  $-3^{\circ}\text{C}$ ) will not occur until 52,000 AD, see Section 7.4.1. Physical/mechanical degradation will occur to such an extent before 52,000 AD that the exact time of freezing is of minor importance. The physical changes influence radionuclide transport mainly due to changes in hydraulic conductivity, porosity and diffusivity. The evolution of the concrete degradation is evaluated in Höglund (2014) and is simplified to be used in the radionuclide transport calculations, see further the Section on Data below.

The chemical degradation of the cementitious materials mainly influences radionuclide transport by changing their ability to sorb radionuclides. Sorption of different radionuclides is affected in different ways by the chemical environment. Complexation with organic ligands, for example ISA, that form soluble complexes with the radionuclides decreases the extent of sorption for many radionuclides. High pH suppresses microbial activity and hence it is judged that microorganisms do not contribute to changed conditions in the repository. Several of the radionuclides are redox-sensitive, with varying retention behaviour depending on the redox state. However, reducing conditions will prevail in the repository in the main scenario (Sections 6.3.7, 6.4.7 and 6.5.7), so this consideration is of limited importance. The chemical degradation of concrete can be divided into four steps, as described in the **Data report** (Section 7.4): degradation state I (dissolution of sodium and potassium hydroxides  $\text{pH} > 12.5$ ), degradation state II (dissolution of portlandite  $\text{pH} \approx 12.5$ ), degradation state IIIa (incongruent dissolution of CSH phases, presence of Ca-aluminates  $\text{pH} \approx 12$ ) and degradation state IIIb (incongruent dissolution of CSH phases, absence of Ca-aluminates  $\text{pH} \approx 10.5$ ). The durations of these stages are different for each waste vault, see further the Section on Data below. The succession of the degradation states is based on the calculations of the pH evolution, as described in Section 6.4.7 and the Section on Data below. The chemical degradation is much slower than the physical/mechanical degradation, which implies that even though concrete has lost its hydraulic barrier function it will constitute a sorption barrier for a long period of time.

### **Radionuclide transport modelling**

Radionuclides in the pore water are transported by diffusion and advection. Sorption on solid surfaces retards the transport of radionuclides. The main processes identified to have an impact on radionuclide transport are radioactive decay and in-growth, advection, diffusion, dispersion, sorption, solubility limitations, speciation, and corrosion. A detailed description of these processes can be found in the **Waste process report** and the **Barrier process report**. A short description of the handling of the processes in the main scenario follows below whereas a more detailed description of the handling in the modelling can be found in the **Radionuclide transport report**.

**Radioactive decay and in-growth:** these processes are included in the modelling by being parameterised by nuclide specific decay constants and branching ratios.

**Advection:** advection is explicitly included in the radionuclide transport modelling. Output from the three-dimensional hydrological models includes water fluxes between control volumes to be represented by compartments (or groups of compartments) in the radionuclide transport model. These water fluxes are propagated as input data to the radionuclide transport model and used together with volumes and sorption data for waste vaults, to calculate the retention and advective transport of radionuclides. As the water fluxes are calculated for various degradation states, the modelling implicitly takes into account the expected degradation of the barriers over time. For the 1–2BMA waste vaults, the possible future occurrence of larger fractures is modelled explicitly by an advective transfer directly through the barriers, without taking into account the sorption in the barriers.

**Diffusion:** diffusion is explicitly included in the modelling. The calculations take into account the material-specific effective diffusivities, as well as the porosities and compartmental geometries (transport lengths and cross-sectional areas) of the waste packages and barriers. The effective diffusivities are increased over time to describe a gradual degradation of the barriers. Diffusive resistance is neglected for bitumen-stabilised wastes (a pessimistic assumption). No diffusion resistance is taken into account for the concrete structure in the BRT vault. This structure is modelled as a stirred tank.

**Dispersion:** dispersion is not handled explicitly in the modelling. The coarse spatial resolution of the compartmental structure introduces a dispersive effect with respect to radionuclide transport in the system. This numerical dispersion can be assumed to be larger than the real physical dispersion and hence this treatment is regarded as cautious, see further the **Radionuclide transport report**.

**Sorption:** sorption (on an immobile solid phase) has a retarding effect on both advective and diffusive transport of radionuclides. Sorption is explicitly included in the radionuclide transport modelling using a linear approach, based on element-specific  $K_d$  values.

**Solubility limitation:** solubility limitation of elements is not considered in the main scenario (a pessimistic approach). However, the effect of solubility limitation has been investigated in specific supporting calculations, see the **Radionuclide transport report**.

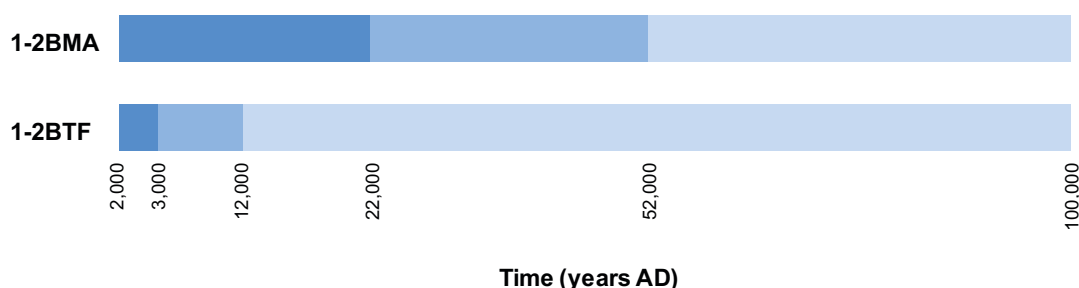
**Speciation:** speciation of radionuclides is considered by the use of specifically determined (time dependent) partitioning coefficients for sorption ( $K_d$  values).

**Corrosion:** the reactor pressure vessels in the BRT vault contain radionuclides produced as a result of neutron activation of the steel during the operation of the reactor. The reactor pressure vessels are also contaminated on the surface by radionuclides present in the reactor water. It is assumed that the fraction of the radionuclides that originates from neutron activation is released as the steel corrodes. The slow corrosion rate of the reactor pressure vessels will limit radionuclide release. The process was modelled as a rate of release of nuclides based on the corrosion rate for steel under repository conditions (i.e. the radionuclides are released congruently as the steel corrodes and no retention in the corrosion products was considered).

## Data

The radionuclide inventory in the main scenario is the best estimate presented in Table 4-6. The radionuclide inventory of each waste type is given in the inventory report (SKB 2013a, SKBdoc 1481419 for Mo-93) and the number of waste packages of each waste type in each waste vault is given in the **Initial state report**. For NHB, only data from the inventory report (SKB 2013a) was used. The geometry of the repository is described in the **Initial state report** and the implementation in the models is described in the **Radionuclide transport report**.

The **Data report** (Table 10-4) presents hydraulic conductivities as a function of time depending on the degradation of the cementitious materials. Results from repository hydrology calculations are given for different combinations of hydraulic conductivities and shoreline positions (Abarca et al. 2013, 2014) as described in Sections 6.3.5 and 6.4.5. Results from the calculation cases representative of the development of the hydraulic conductivities were selected as input to the radionuclide transport calculations. This implies that water flows for each waste vault are obtained from specific calculation cases depending on both the shoreline position and the degradation of the barriers. Over time, as the barriers are assumed to degrade, the flows go from initial state values to values for moderately, severely and completely degraded barriers, see Figure 7-8. This is explained in detail in Chapter 4 in the **Radionuclide transport report**.



**Figure 7-8.** Illustration of succession of the hydraulic conductivity of the concrete in the main scenario where the three colours represent the degradation from moderately via severely to completely degraded concrete. In the beginning there is a short period with initial state values that is not shown in the figure, details are given in the **Radionuclide transport report**. Only the waste vaults where the concrete constitutes a main flow barrier are shown.

Sorption is modelled by the use of partitioning coefficients,  $K_d$  values, in the radionuclide transport model. Reducing conditions will prevail in the repository in the main scenario and  $K_d$  values for the following oxidation states were selected to be representative: Np(IV), Pa(IV), Pu(III/IV), Se(-II), Tc(IV) and U(IV). Speciation studies for some waste types indicate that Pu will be present as Pu(III) in the waste (Duro et al. 2012), whereas speciation studies for non-glacial waters in the bedrock indicate that both Pu(III) and Pu(IV) might be present (Crawford 2013). The lower  $K_d$  value of those for Pu(III) and Pu(IV) was chosen. All  $K_d$  values were represented by probability density functions.

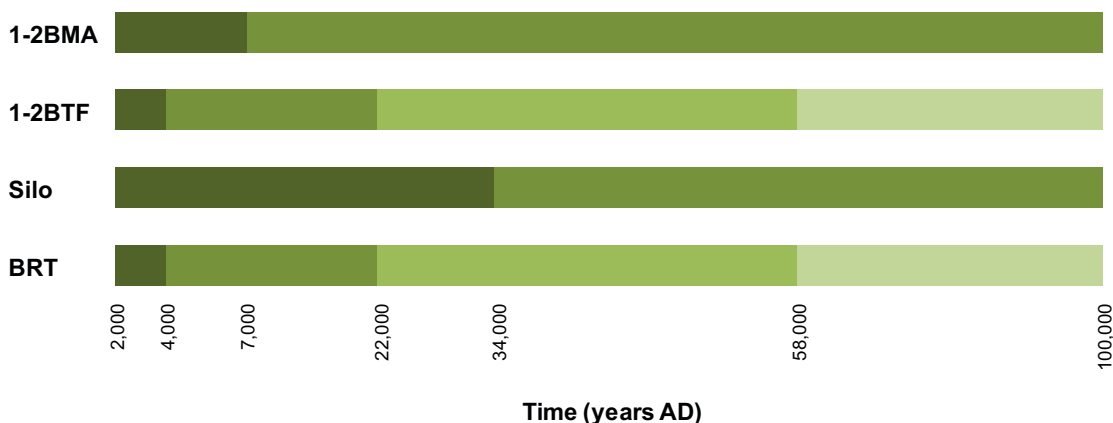
Partitioning coefficients for sorption,  $K_d$  values, for the cementitious materials were calculated from the following.

1.  $K_d$  values for hydrated cement paste at each degradation state as given in the **Data report** (Table 7-7 to Table 7-10). The succession of chemical degradation states is different for every point in space in the waste vaults. However, a simplified succession was used in the radionuclide transport calculations. This simplified succession of chemical degradation states for each waste vault is shown in Figure 7-9.
2. Content of hydrated cement paste in the each type of cementitious material as given in the **Data report** (Table 7-12).
3. Reduction factors due to influence of complexing agents. Concentration-dependent reduction factors are given in the **Data report** (Table 7-11a to Table 7-11c). The concentrations of complexing agents are given in a dedicated reference report (Keith-Roach et al. 2014). The resulting reduction factors are described in the **Input data report** (Section AMF number 75).

Partitioning coefficients for sorption,  $K_d$  values, for the bentonite were selected to be representative for both saline and non-saline groundwaters, i.e. they are representative for the whole assessment period in both variants of the main scenario. The values are given in the **Data report** (Table 7-6).

Partitioning coefficients for sorption,  $K_d$  values, for the macadam/crushed rock are given in the **Data report** (Table 8-7).  $K_d$  values for pH larger than 10 were selected. This is a pessimistic choice, since these  $K_d$  values are equal or lower than those for groundwater pH. Partitioning coefficients for sorption,  $K_d$  values, for the mixtures of sand and bentonite were obtained by using a weighted average from the  $K_d$  values selected for macadam/crushed rock and bentonite and the weight proportions of the two materials. This simple approach was used because of the limited amount of experimental data available on sorption on mixtures of sand and bentonite.

Effective diffusivities, porosities and densities are given in the **Radionuclide transport report**.



**Figure 7-9.** Illustration of succession of the four chemical concrete degradation states for each waste vault in the main scenario. Initially all cementitious materials are in the chemical degradation state I (dissolution of sodium and potassium hydroxides and the pH is higher than 12.5). Thereafter follows degradation state II (dissolution of portlandite  $pH \approx 12.5$ ), degradation state IIIa (incongruent dissolution of CSH phases, presence of Ca-aluminates  $pH \approx 12$ ) and degradation state IIIb (incongruent dissolution of CSH phases, absence of Ca-aluminates  $pH \approx 10.5$ ). Only 1-2BTF and BRT exhibit the full succession during the assessment period of 100,000 years.

The corrosion rates used to describe the release of radionuclides from the reactor pressure vessels were assigned to be dependent on the pH in the waste vault (see Figure 7-9). Corrosion rates for carbon steel for different conditions are given in the **Data report** (Table 5-3). This results in the use of a corrosion rate of 0.05  $\mu\text{m}/\text{yr}$  until 22,000 AD and 2.8  $\mu\text{m}/\text{yr}$  thereafter.

#### 7.4.4 Surface systems

The development of the surface systems in the main scenario follows the reference evolution of the surface systems described in Sections 6.3.1, 6.4.1 and 6.5.1. Shoreline regression continues at a slowly declining rate, bringing new areas of the sea floor above the wave base. As a consequence, there is a succession from marine to lake to wetland ecosystems. Sometimes, wetlands are developed without an intermediate lake stage. Once a site is located high enough above the shoreline to prevent saltwater intrusion, it may be drained and used as farmland. The assumed development in the main scenario is that a potential release of radionuclides will initially be to marine basins, but, as land emerges, release will be directed towards wetland or lake ecosystems (Section 7.4.2 and Figure 7-3). The potential release to a primary discharge area is also assumed to be distributed to other areas through connected sea basins or to downstream lakes/wetlands via surface water flows (Section 8.2.3).

At the beginning of the assessment period, shoreline displacement has a major impact on the development of the ecosystems. In the longer term, when the shoreline has passed the repository area and the lakes are infilled, climatic variations become increasingly important (see Section 6.4.1). During future periods of periglacial climate and associated permafrost conditions, unfrozen areas in the otherwise frozen landscape, so-called taliks, may occur under lakes and wetlands. Since negligible water flow occurs in frozen ground, radionuclide transport from the repository to the surface can only occur in the taliks (Section 6.5.4). Hydrological fluxes in surface systems are altered during periglacial conditions compared with temperate conditions. Therefore, modelled hydrological fluxes in taliks (Werner et al. 2013) are applied in radionuclide transport modelling of the first periglacial period of the *early periglacial variant* of the main scenario, i.e. between 17,500 AD and 20,500 AD.

Exposure of humans and non-human biota is described in Section 7.4.5.

#### **Radionuclide transport modelling**

Transport of radionuclides in the surface system is simulated in the radionuclide transport model. Radionuclides reach the surface ecosystem via groundwater flow in discharge areas (biosphere objects). Transport of radionuclides in the surface ecosystem is linked mainly to mass fluxes of water, but also to fluxes of gas and solid matter, transitions between organic and inorganic forms, and diffusion in soil pore water. The transport of radionuclides in the surface system is dependent on the development of the surface ecosystem, characteristics of the discharge areas, and climate. The radionuclide transport calculations in the surface systems are further described in Section 8.2.3.

#### **Data**

The development of ecosystems is important for the transport of radionuclides. Section 6.4.1 illustrates how the landscape changes in the main scenario, based on shoreline displacement and succession of ecosystems with an increasing proportion of wetlands and the potential for agriculture. In the modelling of radionuclide transport in the surface systems (described in Chapter 8) a number of different data are used. The distribution of ecosystems in the discharge areas (Biosphere objects) over time is important input data. However, also water fluxes; regolith distribution, depth and characteristics; sorption ( $K_d$ ); ecosystem-specific parameters (such as production, decomposition, mineralisation of organic matter, and degassing of carbon), and uptake by biota (represented by Concentration Ratios, CR values) are important for the transport of radionuclides within ecosystems. Parameters used for transport of radionuclides in the surface systems are summarised in the **Biosphere synthesis report** and described in detail in Grolander (2013).

### 7.4.5 Exposure of humans and non-human biota

Radionuclide concentrations in soil, water, air and organisms are used when calculating the effective dose to humans and dose rate to non-human biota (other organisms) (Chapters 8 and 9). Dose to humans is used in the risk assessment (Chapter 10). Doses to humans and other organisms arise from external exposure (radiation from the ground, air and water), inhalation of radionuclides, and ingestion of radionuclides through food and water. The concentration of radionuclides over time in different parts of the ecosystems is calculated using a radionuclide transport model that includes transport from the repository (near-field), through the rock (geosphere/far-field), and in the surface systems (biosphere). Due to the evolution of the repository and of the geosphere, surface systems and climate (see Chapter 6 and Sections 7.4.1–7.4.4), the concentrations of radionuclides in different environmental media in the surface systems will change over time.

#### Exposure of humans

In addition to the radionuclide concentrations, dose to humans depends on living habits and diet.

Human can use the land in many different ways, but the highest doses are expected if humans spend time in the land areas with the highest radionuclide concentrations, and drink water and eat food originating from these areas (Figure 7-10). Four different land-use variants have been defined to cover a range of possible future human exposure pathways. The exposed groups are credible bounding cases, reflecting land use and habits that are reasonable and sustainable with respect to the Forsmark area as well as human physiological requirements. Different exposure routes have been identified in an analysis of exposure pathways resulting in a total of 17 exposure routes that were included in the safety analysis by including them in one (or more) of the four different variants of land use (**Biosphere synthesis report**). Figure 7-11 shows the main exposure pathways for the four variants of land use. These are also described below (comprehensive descriptions of the land-use variants and all exposure routes are given in the **Biosphere synthesis report**).

**Hunters and gatherers** – A hunter-gatherer community using the undisturbed ecosystems for living space and food. The major exposure pathways are from foraging the landscape (fishing, hunting, and collecting berries and mushrooms), and from drinking water from surface water bodies (streams or lakes). A typical hunter-gatherer community is assumed to be made up of 30 persons that utilise a forage area of 200 km<sup>2</sup>.

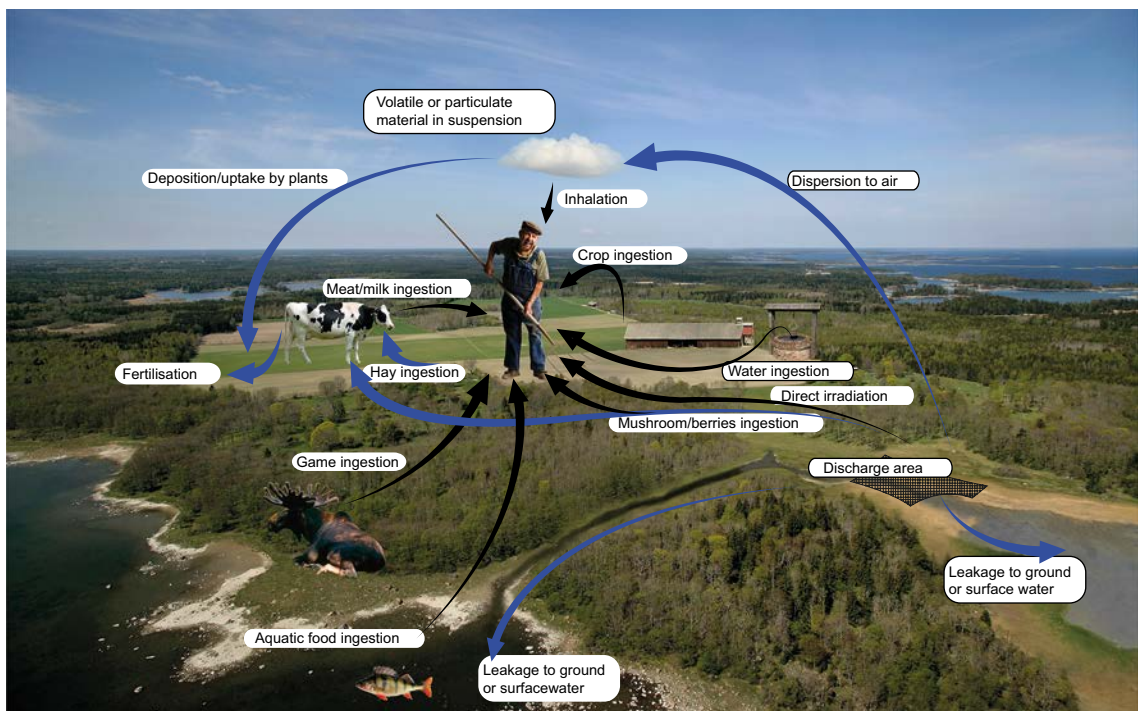
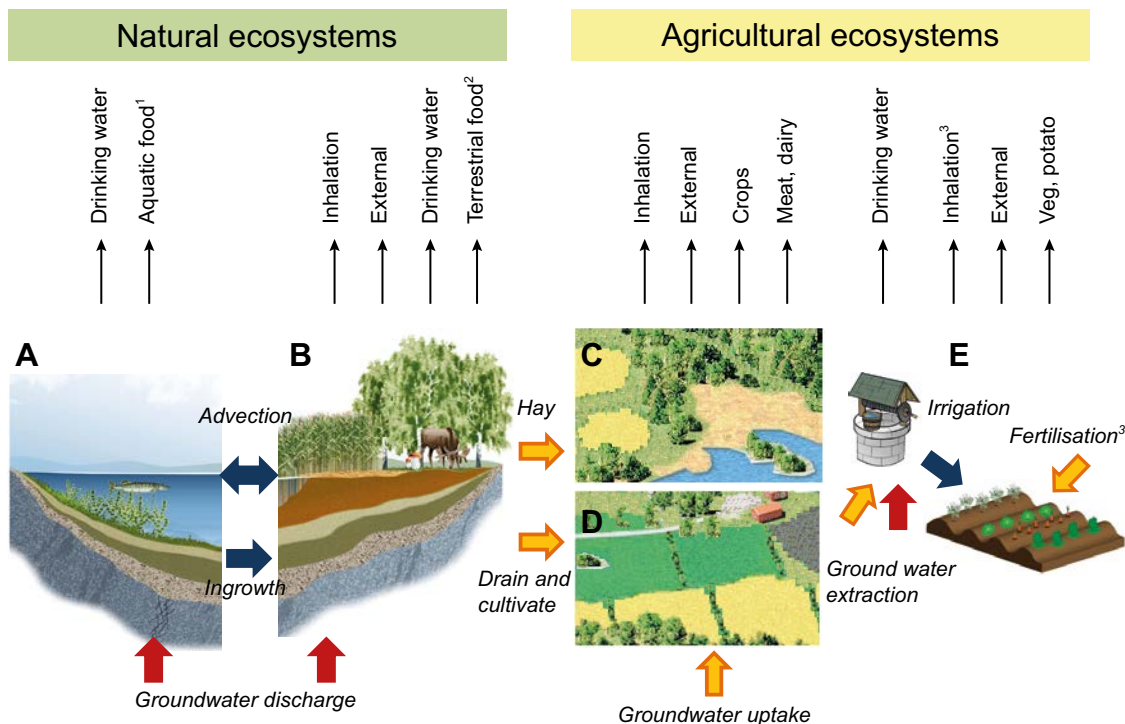


Figure 7-10. Potential exposure pathways for humans.



**Figure 7-II.** Exposure pathways included in the dose calculations for exposed populations using natural resources and/or living in biosphere objects. Hunter-gatherers use natural aquatic (A) and mire (B) ecosystems. The other three exposed populations represented different uses of arable land, namely infield-outland agriculture (C), draining and cultivating the mire (D) and small scale horticulture on a garden plot (E). Bold arrows represent input of radionuclides from the bedrock (red), from natural ecosystems or deep regolith deposits (orange), or water-bound transfer of radionuclides within the biosphere (blue). The thin arrows (top) represent exposure routes. 1 = fish and crayfish, 2 = game, berries and mushrooms, 3 = the exposure pathway inhalation and fertilisation includes radionuclides from combustion of biofuel.

**Infield-outland farmer** – Self-sustained agriculture in which inland farming of crops is dependent on nutrients from wetlands for haymaking (outland), i.e. the wetlands that may contain radionuclides originating from the repository are used as outland. The major exposure pathways are from meat from animals that have eaten hay from the wetlands, from crops fertilised with manure from the animals, and from drinking water from either a dug well or from surface water in the biosphere object. A sustainable community of infield-outland farmers is assumed to be 10 persons. A wetland area of 0.1 km<sup>2</sup> would be needed to supply winter fodder for the herd of livestock corresponding to the need of manure for infield cultivation of this group.

**Drained-mire farmer** – Self-sustained agriculture in which wetlands are drained and used for both crop and fodder production. The major exposure pathways are from growing food on land where radionuclides have accumulated for an extended period, and from drinking water from either a well (dug or drilled) or from surface water in the biosphere object. A sustainable community of drained-mire farmers is assumed to be 10 persons. A wetland area of 0.06 km<sup>2</sup> would be needed for food production.

**Garden plot household** – A household that is self-sustained with respect to vegetables and root crops produced through small-scale horticulture. The major exposure pathways are from vegetables and root crops irrigated with water containing radionuclides and from using either a well (dug or drilled) or surface water for drinking. Exposure from burning biomass is also considered for this population. A garden plot household is assumed to be made up of 5 persons and a 140 m<sup>2</sup> area garden plot is enough to support the family with vegetables and root crops.

The hunter-gatherer community uses undisturbed ecosystems, whereas the other three groups actively cultivate the land. During marine and periglacial periods, only natural ecosystems can be used for food and water supply. When the shoreline has passed, the possibility of using part of the area for agriculture and water supply (by drilling wells) increases. Wells can be drilled and mires can be



drained and used for agriculture when the risk of salt water intrusion decreases, which is estimated to be when the land is at least 1 m above sea level. In the areas that emerge early from the sea, only minor parts of the newly formed land will have the potential for cultivation due to boulder-rich regolith in the former sea and lake areas (Lindborg 2010), but, for example, in the central parts of Öregrundsgrepen, there are large areas that mainly consist of clay and sand that can be suitable for agriculture (Figure 6-18). In the smaller area north of the repository, which is of particular interest in the main scenario (due to discharge from the repository to that location, see Figure 7-3), there are small areas where agriculture might be possible.

### **Exposure of non-human biota**

Concerning exposures of plants and animals, one challenge is to limit the number of types of organism to be included in the analysis. This is discussed more thoroughly in Jaeschke et al. (2013), where a comprehensive comparison is made between species that have been identified as representative for the Forsmark region and the reference organisms that have been identified in the ERICA Project to represent organism types that can be expected to receive the highest exposures in different ecosystems (Beresford et al. 2008). As described in Saetre et al. (2013), the reference organism concept was applicable in most cases and only a few changes and additions have been made in this assessment in order to capture important site-specific aspects. For example, one small benthic limnic primary producer has been added to represent the microphytobenthos present in thick layers in the lake sediment in many of the lakes in the Forsmark area today (Andersson 2010). Two site-specific birds and a mammal that utilise aquatic as well as terrestrial habitats have also been added in order to include the combination of exposures from several ecosystem types.

The types of ecosystem included in the analysis of exposure of non-human biota are sea, lake/streams and mire. Agricultural ecosystems have not been considered relevant in the analysis. Even if wetlands may be drained and cultivated, these agricultural soils are expected to be productive (and thus provide a stable environment) for 100 years or less (Lindborg 2010). Species associated with this land would either be introduced by humans (crops or livestock), or immigrate from adjacent land and consequently they would be part of larger and more stable biological populations. These populations are also actively manipulated by humans. The exclusion of farmed animals from the analysis of exposure of non-human biota is consistent with the ICRP view (ICRP 2008) that the protection of humans themselves is probably sufficient for such managed environmental or ecological situations.

In total, 41 organism types have been included in the analysis of exposure of non-human biota, see Table 7-1 (13 limnic, 11 marine, 14 terrestrial, 2 marine and terrestrial, and one limnic and terrestrial, i.e. the latter types utilise two ecosystems). As recommended by Jaeschke et al. (2013), among others, site data are used to describe radionuclide uptake in organisms (by so called concentration ratios, CR values, see Grolander 2013).

**Table 7-1. Organism types included in the analysis of exposure of non-human biota in SR-PSU (Biosphere synthesis report).**

Terrestrial ecosystem	Marine ecosystem	Limnic ecosystem	Marine and terrestrial ecosystems	Limnic and terrestrial ecosystems
Lichen and bryophytes	Phytoplankton	Phytoplankton	European otter	Black tern
Grasses and herbs	Macroalgae	Microphytobenthos	Ruddy turnstone	
Shrub	Vascular plant	Vascular plant		
Tree	Zooplankton	Zooplankton		
Soil Invertebrate	Polychaete worm	Insect larvae		
Detritivorous invertebrate	Benthic mollusc	Bivalve mollusc		
Flying insects	Crustacean	Gastropod		
Gastropod	Benthic fish	Crustacean		
Amphibian	Pelagic fish	Benthic fish		
Reptile	(Wading) bird	Pelagic fish		
Bird	Mammal	Amphibian		
Bird egg		Bird		
Mammal (small)		Mammal		
Mammal (large)				

## 7.4.6 Safety functions in the main scenario

The safety functions (described in detail in Chapter 5) are used to select less probable scenarios by going through routes to violation of the safety functions, i.e. if they deviate from the status in the main scenario. Below follow the assumptions regarding the status of the safety functions in the main scenario. The status of the safety functions in the main scenario is based on the initial conditions specified in Chapter 4 and the reference evolution described in Chapter 6. While the reference evolution, as presented in Chapter 6, is defined as a range of possible future evolutions of the SFR repository system, the main scenario is more specific in order to permit the evaluation of the radiological risk. The wider ranges of conditions covered in the reference evolution, but not in the main scenario, are evaluated in the less probable scenarios.

### **Limited quantity of activity**

The safety function *limited quantity of activity* is assessed with the aid of the safety performance indicator *activity of each radionuclide in each waste vault*. The amount of activity in the waste is limited by only accepting certain kinds of waste in SFR, and the quantity of activity in each waste vault is regulated. In the main scenario, this safety function is established initially and the activity is as given in Table 4-6.

### **Low flow in bedrock**

The safety function *low flow in bedrock* is assessed with the aid of the safety performance indicators: *hydraulic conductivity* and *hydraulic gradient* in the bedrock.

**Hydraulic conductivity** – The hydraulic conductivity in the bedrock is influenced by mechanical and chemical processes. These conditions are not expected to change significantly during the assessment period (Sections 6.3.3 and 6.3.6). Therefore, the hydraulic conductivity in the bedrock surrounding SFR is assumed to be constant throughout the assessment period. The hydraulic conductivity in the main scenario is based on the site investigations as described in Section 4.7.1 and explicitly described by the intermediate-level flow bedrock case as described in Section 7.4.2.

**Hydraulic gradient** – The hydraulic gradient in the surrounding rock increases significantly during the first 3,000 years after closure due to the shift from submarine to shoreline and terrestrial-dominated conditions in the area above the repository (Sections 6.3.4 and 6.4.4). When land conditions have been established above the repository, the flow direction and the hydraulic gradient stabilise and are assumed to be constant for the remainder of the assessment period (Section 7.4.2).

### **Low flow in waste vaults**

The safety function *low flow in waste vaults* is assessed with the aid of the safety performance indicators: *hydraulic contrast*, *hydraulic conductivity* and *gas pressure*. The effect on the flow through the waste varies between vaults. In general, the effect of the changing hydraulic gradient during the first 1,000 years on the flow through the waste is more important than the influence of concrete degradation (hydraulic contrast).

**Hydraulic contrast** – The hydraulic contrast between the concrete structures and the backfill is maintained by the concrete structures which constitute flow barriers in 1–2BMA and 1–2BTF. This property is influenced by degradation processes in the concrete, damaging pressures and stresses, and freezing. Leaching of portlandite is one of the central degradation processes, causing porosity changes in the concrete materials (Section 6.3.8). All the processes together are expected to lead to a shift in hydraulic properties after repository closure resulting in increased flow through the waste vaults (Sections 6.3.5 and 6.4.5).

In 1–2BMA, the hydraulic contrast between the moderately degraded concrete and the highly permeable backfill remains large. After 20,000 years, when concrete degradation is expected to be more severe, the hydraulic contrast still contributes to diverting vault flow through the backfill (Section 6.4.5). The waste sections contain a sufficient amount of cement to enable all the sulphate released from the waste to form ettringite within the waste sections (Section 6.3.8). However with the passage of time the concrete barriers close to the sulphate-containing waste could locally be

affected. Grouting of the waste compartments in 1BMA and the caissons in 2BMA will be done so that sufficient void volume is provided to prevent the potentially swelling waste from exerting excessive pressure on the surrounding barriers (Sections 2.3.3, 6.3.7 and 6.3.8). The hydraulic contrast decreases with time due to the succession of the hydraulic conductivity of the concrete as is shown in Figure 7-8.

Since the waste in BTF and BRT vaults is not completely contained in concrete structures, but in concrete grout and in addition they are not completely surrounded by high permeability backfill, the hydraulic contrast in the BTF and BRT vaults is smaller than in 1–2BMA. Extensive portlandite leaching and chemical degradation of the BTF concrete tanks is expected, which results in a significant change in their porosity and hydraulic conductivity, reducing the hydraulic contrast. The corrosion of reinforcement bars and other steel components is only expected to lead to some minor fracturing during the first 1,000 years after closure (Section 6.3.8). The process is not expected to cause any significant changes during the first 1000 years, but as corrosion and chemical degradation of the BTF concrete tanks proceed it will contribute to the reduction of the hydraulic contrast. The concrete tanks in BTF contain sufficient void volume to prevent the potentially swelling waste from exerting excessive stress on the walls of the concrete tanks (Section 6.3.8). The hydraulic contrast decrease with time due to the succession of the hydraulic conductivity of the concrete as is shown in Figure 7-8.

Periglacial conditions can affect the hydraulic contrast by freezing of the concrete barriers. Freezing of SFR will always occur in an approximately vertical thermal gradient, with temperature increasing with depth. Under many circumstances, therefore, freezing will not cause increased pressures as water can be expelled downwards. However, because freezing point depression will be different in different components of the repository, situations will also occur where “trapped” water will freeze and induce damaging pressure and stresses. The first timing of a bedrock temperature of  $-3^{\circ}\text{C}$  or lower, which is necessary for concrete structures to freeze, occurs after 52,000 AD in both variants of the main scenario (Section 7.4.1). However concrete degradation will occur to such an extent before 52,000 AD that the effect of freezing of concrete is of minor importance for the hydraulic contrast.

**Hydraulic conductivity** – The safety performance indicator *hydraulic conductivity* is relevant for the bentonite in the silo and the plugs. One of the most important features of bentonite with regard to its use as a barrier is its swelling capability, which is responsible for the low hydraulic conductivity. The high pH in the water will gradually transform montmorillonite, which will result in reduced swelling capacity of the bentonite. However, in the main scenario, the safety function is maintained throughout the assessment period (see Section 6.3.8). The lower part of the silo wall has a hydraulic conductivity of  $9 \cdot 10^{-12}$  m/s and the upper part about  $9 \cdot 10^{-11}$  m/s. The hydraulic conductivity of the bentonite in the plugs is  $1 \cdot 10^{-12}$  m/s.

**Gas pressure** – The safety performance indicator *gas pressure* is only selected for the silo. Only a small gas pressure is required for gas to be transported through concrete packages, porous concrete and the concrete structure in the silo. In order for the gas to find its way out through the gas evacuation pipes and the sand/bentonite barrier in the top, a gas pressure must be built up equivalent to the opening pressure of the sand/bentonite barrier. The chemical reactions that are expected to occur in the sand/bentonite barrier are not likely to lead to a significant change in the opening pressure of the sand/bentonite barrier. In the main scenario, the safety function is maintained throughout the assessment period (see Section 6.3.8).

### **Good retention**

The safety function *good retention* is assessed with aid of the safety performance indicators: *pH*, *redox potential*, *concentration of complexing agents*, *available sorption surface area* and *corrosion rate*. Retardation of radionuclide transport is linked to sorption, where sorption of radionuclides on concrete lowers the concentration in the pore water. The available concrete sorption surface area and the pH of the pore water affect sorption.

**pH** – The pH is controlled, after the initial stage where sodium and potassium hydroxides sets the pH to above 12.5, by the dissolution of portlandite, which is affected by the water flow in the cementitious materials. The average pH in 1–2BMA and the silo is expected to vary between hyperalkaline (pH > 13) to alkaline (pH  $\approx$  12.5) during the whole assessment period, see Figure 7-9. The pH in the

waste domain in 1–2BTF will also be high with a pH of about 12.5 (see Section 6.4.7), while the average pH in 1–2BTF is expected to decrease, according to the degradation states of concrete, resulting in a pH of about 12 between 22,000 AD and 58,000 AD and a pH of about 10 thereafter, see Figure 7-9. The pH in the 1BLA vault continues to drop and will reach typical groundwater values after about 19,000 years.

**Redox potential** – Highly reducing conditions are quickly established in all waste vaults after closure and resaturation of the vaults (see Section 6.3.7). Corrosion of iron will provide a reducing environment in all wastes. The reducing capacity of the wastes is not expected to be depleted within the 100,000-year timeframe of the assessment. The corrosion of iron and the formation of iron corrosion products will cease during periods of permafrost at repository depth.

**Concentration of complexing agents** – Initially the aqueous concentrations of complexing agents will be governed by the presence of complexing agents deposited in the waste. Subsequently, under the hyperalkaline (pH > 13) to alkaline (pH ≈ 12.5) conditions prevailing in most of the waste vaults, cellulose will be degraded to ISA. This reaction proceeds relatively quickly initially and then at an increasingly slower rate as the rate-determining step in the degradation process changes. For some of the compartments in 1BMA, critical levels, as indicated in Table 3-7 and Table 3-9 in Keith-Roach et al. (2014) and Table 6-6, are exceeded for both ISA and NTA (nitrilotriacetic acid). The calculated concentration of NTA exceeds the critical level in the silo as well. Studies of organic cement additives by SKB and the Paul Scherrer Institute (PSI) have led to the conclusion that cement additives will only have a minor influence compared with other complexants. In the case of the 2BMA vault, the preliminary waste acceptance criteria (SKBdoc 1368638) do not permit cellulose quantities large enough for sorption to be affected due to ISA formation. This corresponds to about 2,600 kg cellulose/caisson, given present knowledge about degradation rates and the impact of sorption on actinides. Degradation of cellulose to ISA and mobilisation of radionuclides due to ISA complex formation will not take place during periods of permafrost at repository depth.

**Available sorption surface area** – Concrete has a large specific surface area that favours sorption. Degradation of the concrete will affect the available sorption surface area. The flow rates through all concrete barriers are sufficiently low for effective sorption as long as the flow barriers do not degrade completely resulting in the flow becoming localised to a few major fractures. The available surface area will not change during periods of permafrost. When the water melts again the available surface area will change due to fracturing of the concrete.

**Corrosion rate** – In the BRT vault, the reactor pressure vessels themselves comprise a barrier to radionuclide release. The release of neutron induced radioactivity in the steel is controlled by the corrosion rate. The corrosion rate is determined by the pH and the redox conditions. When all water is frozen, corrosion and transport of radionuclides will not take place since liquid water is required for these processes. The data used for corrosion is given in the section on Data in Section 7.4.3.

### ***Avoid wells in the direct vicinity of the repository***

The safety function *avoid wells in the direct vicinity of the repository* is assessed with the aid of the safety performance indicators: *intrusion wells* and *wells downstream of the repository*.

Wells are included in the main scenario for the exposed populations related to agriculture (see Section 7.4.5). The wells in the main scenario are situated in connection to agricultural land within the areas where radionuclides from the repository could reach surface systems (biosphere objects, see Appendix H). These areas are some distance away from the repository and it is reasonable that humans settling in the area would have their water resource close to home and thereby wells are not assumed to be situated in the direct vicinity of the repository in the main scenario.

Wells are not drilled as soon as land has emerged. Rather, a minimum height above sea level is needed in order to be able to drill and prevent sea water intrusion in the wells. For agricultural areas, it is assumed that wells are found in areas 1 m or more above sea level (m.a.s.l.) (Werner et al. 2013). The area above the repository and in the direct vicinity downstream of the repository (where the concentrations of radionuclides in the groundwater at repository depth could be expected to be higher than further away) will not be suitable for agricultural purposes due to the geological composition of the regolith (Sohlenius et al. 2013a). Moreover, for areas not suitable for agriculture, data from the national well database (SGU 2011) indicate that wells are not drilled so close to the shoreline.

## 7.5 Selection of less probable scenarios

Less probable scenarios of relevance for assessing the long-term safety of the repository are arrived at by considering the safety functions presented in Table 5-3 and identified FEPs (see Chapter 3). Scenarios are selected by going through possible routes to violation of each safety function, i.e. by examining the uncertainties in initial state, internal processes and external conditions that could lead to deviation from the status of the safety function in the main scenario in such a way that a lower degree of safety is indicated.

### 7.5.1 Routes to violation of the safety function limited quantity of activity

The uncertainties of importance for the status of the safety function *limited quantity of activity* are identified as described in the beginning of Section 7.5. The safety function *limited quantity of activity* is assessed with the aid of the safety performance indicator *activity of each radionuclide in each waste vault* (see Section 5.3).

#### Initial state

- Radionuclide inventory.

The inventory used in the main scenario (given in Table 4-6) is based on estimates of future operational and decommissioning wastes. The disposal strategy and procedures ensure, together with waste type descriptions, that the waste acceptance criteria are met. It is not reasonable to assume that waste is, for any reason, placed in the wrong waste vault. Deviations in radionuclide inventory are only deemed to be possible due to data uncertainties in the deposited, and above all in the future, waste. These uncertainties are judged to be of such importance that a *high inventory scenario* is selected, see Section 7.6.1.

#### Internal processes and external conditions

No internal process or external condition has been identified that could cause the radionuclide inventory to deviate from the inventory in the main scenario.

### 7.5.2 Routes to violation of the safety function low flow in the bedrock

The uncertainties of importance for the status of the safety function *low flow in bedrock* are identified as described in the beginning of Section 7.5. The safety function *low flow in bedrock* is assessed with the aid of the safety performance indicators: *hydraulic conductivity* and *hydraulic gradient* in the bedrock (see Section 5.4).

#### Initial state

- Hydraulic conductivity.
- Hydraulic gradient.

There are uncertainties in the data used to describe the rock in the hydrogeological flow model that are not included in the main scenario. The heterogeneity of the deformation zones that intersect the waste vaults and the conceptual uncertainty when parameterising the deformation zones (local conditioning to measured borehole transmissivity values and depth trend in deformation zone transmissivity) imply uncertainties in the hydrogeological model, which lead to bedrock cases with higher cross flow through the waste vaults than in the main scenario. These uncertainties are judged to be of such importance that a *high flow in the bedrock scenario* is selected to be studied, see Section 7.6.2.

#### Internal processes

By definition this safety function treats the internal process groundwater flow. No other internal process is identified to influence the groundwater flow to such an extent that it will have a larger impact than the uncertainties in the fracture network models. Degradation of the grout in the rock is theoretic-

cally an important process. However, the influence of grout has pessimistically been disregarded in the hydrogeological model by not considering its flow-limiting capability.

### External conditions

- Shoreline displacement.
- Periglacial conditions.
- Earthquakes.
- Ice-sheet dynamics.

Uncertainties in the shoreline displacement due to uncertainties in the eustatic (sea-level) contribution are included in the *extended global warming climate case*, see Section 6.2.2. These uncertainties are not expected to result in deviations from the status of the safety function in the main scenario in such a way that a lower degree of safety is indicated. Therefore, this future evolution is treated in a residual scenario, the *extended global warming scenario*, see Section 7.7.5. Uncertainties in the timing of the first occurrence of periglacial conditions are included in the main scenario, while ice-sheet dynamics and damaging earthquakes are not. During 100,000 years, neither glacial conditions nor earthquakes leading to damage can be excluded. An earthquake may lead to increased flow in the bedrock. Hence the *earthquake scenario* is selected to study the impact of an earthquake, see Section 7.6.5.

Ice-sheet dynamics will lead to changes not only in the groundwater flow but also to considerable changes of the repository and its surroundings. The effect of ice-sheet dynamics is treated in a residual scenario, the *glacial and post glacial conditions scenario*, see Section 7.7.8.

### 7.5.3 Routes to violation of the safety function low flow in waste vaults

The uncertainties of importance for the status of the safety function *low flow in waste vaults* are identified as described in the beginning of Section 7.5. The safety function *low flow in waste vaults* is assessed with the aid of the safety performance indicators: *hydraulic contrast* (1–2BMA, 1–2BTF), *hydraulic conductivity* (silo) and *gas pressure* (silo) (see Section 5.4).

#### Initial state

- Hydraulic conductivity of concrete and macadam/crushed rock (hydraulic contrast).
- Hydraulic conductivity of bentonite.
- Gas pressure.

Uncertainties in the initial hydraulic conductivities and gas pressure are judged to be secondary to the evolution of the conductivities and gas pressure due to influences from internal processes and external conditions.

#### Internal processes

- Degradation of concrete.
- Degradation of bentonite.
- Gas formation.
- Water flow/Water transport.

Degradation of concrete is caused by a number of interacting processes as described in Sections 6.3.8, 6.4.8 and 6.5.8. More extensive and faster physical degradation leads to increased fracturing and thereby increased hydraulic conductivities in the concrete structures. The *accelerated concrete degradation scenario* arises from uncertainties in, mainly the rate of, concrete degradation processes, see Section 7.6.3.

Uncertainties in the consequences of degradation processes in the bentonite, for example montmorillonite alteration due to interactions with cementitious materials (Section 6.3.8) and consequences of freezing of bentonite (Section 6.5.8) may be larger than assumed in the main scenario. The *bentonite degradation scenario* is selected mainly to study uncertainties in the consequences of freezing, but can also be seen as indicative for the consequences of uncertainties in other bentonite degradation processes. Freezing of bentonite is further handled in the section External conditions below.

Gas formation inside the silo has been studied and judged to be acceptably low to allow the gas to escape through the evacuation pipes without any harmful pressure build-up (see Section 6.3.8). The consequences of a postulated pressure build-up have been evaluated to be small (Moreno and Neretnieks 2013). Therefore no scenario to evaluate effects of uncertainties in the gas pressure in the silo has been selected.

The groundwater flow in the bedrock has a direct influence on the flow in the waste vaults, this is treated via the scenario *high flow in the bedrock scenario* in Section 7.6.2, where the water flow in both the bedrock and in the waste vaults is higher than in the main scenario. Combination of increased water flow and degradation processes are assessed in Section 7.8.

### External conditions

More extensive periglacial conditions may lead to formation of ice-lenses to such an extent that, in combination with uncertainties in the sealing properties of the bentonite, these conditions may lead to increased hydraulic conductivity of the bentonite (Section 6.5.5). The *bentonite degradation scenario* is selected to study uncertainties in the consequences of extensive periglacial conditions, see Section 7.6.4.

The climatic conditions in both variants of the main scenario (*global warming variant* and *early periglacial variant*) imply that freezing of concrete will not occur until 52,000 AD, see Section 7.4.1. However, the physical/mechanical degradation will occur to such an extent before 52,000 AD that the exact time of freezing is of minor importance.

The consequences of an earthquake may lead to increased flow in the waste vaults. Hence the *earthquake scenario* is selected to study the impact of an earthquake, see Section 7.6.5.

Ice-sheet dynamics will lead to changes in the groundwater flow but also to considerable changes of the repository and its surroundings, both influencing the flow in the waste vaults. The effect of ice-sheet dynamics is treated in a residual scenario, the *glacial and post glacial conditions scenario*, see Section 7.7.8.

### 7.5.4 Routes to violation of the safety function good retention

The uncertainties of importance for the status of the safety function *good retention* are identified as described in the beginning of Section 7.5. The status of the safety function *good retention* is assessed with aid of the safety performance indicators: *pH*, *redox potential*, *concentration of complexing agents*, *available sorption surface area* and *corrosion rate* (see Section 5.4).

#### Initial state factors

- pH.
- Redox potential.
- Available surface area.
- Corrosion rate.
- Amounts of complexing agents and cellulose.

The uncertainties in the initial state regarding pH, redox potential, available sorption surface area and corrosion rate are judged to have minor importance, while the uncertainties in the amounts of complexing agents and cellulose are of importance. Two main factors are identified to contribute to the uncertainties in the complexing agents: i) the amount of water available for dissolution of compounds ii) the amounts of complexing agents and cellulose deposited in SFR (Keith-Roach et al.

2014). The *high concentrations of complexing agents scenario* is selected to study the effects of higher amounts of complexing agents and cellulose than in the main scenario, see Section 7.6.5.

Colloids that might influence the retention of radionuclides are judged to be present in negligible concentrations in the pore water due to the high ionic strength of the pore water. The *high concentration of complexing agents scenario* is judged to also cover the uncertainties in this factor.

### Internal processes

- Degradation of concrete (pH, available surface area, corrosion rate).
- Metal corrosion (redox potential).
- Degradation rate of cellulose (concentration of complexing agents).

The influence of chemical degradation of concrete on its sorption capacity is judged to be sufficiently cautiously treated in the main scenario that no additional scenario is selected. An upper bound of the influence of sorption in concrete is given by the residual scenario *loss of barrier function scenario – no sorption in the repository*.

The evaluation of the influence from metal corrosion on the redox conditions in the repository has excluded the risk of oxidising conditions (see Section 6.3.7). However the effect of oxidising conditions in the repository is studied in the residual scenario *changed repository redox conditions in SFR 1 scenario*, see Section 7.7.4.

The degradation rate of cellulose could possibly introduce an uncertainty, but this will not affect the total concentration, since ISA is effectively retained in the repository by sorption. Instead, the time at which the maximum concentration will be reached is affected. Uncertainties regarding long-term cellulose degradation introduce an uncertainty, since it is necessary to extrapolate data from short-term experiments. This could lead to an overestimation of the ISA produced by cellulose degradation if the reaction rate decreases to such levels that cellulose will not be completely degraded during the assessment period. The cautious assumption with fast degradation implies that the main scenario can be regarded as an upper boundary for the degradation process and hence it is not meaningful to select any additional scenario.

### External conditions

Varying groundwater compositions, as a result of varying external conditions, have been considered in the reference evolution/main scenario by this the effects of varying external conditions have indirectly been included in the parameters for the internal conditions.

The intrusion of oxygenated water occurring under post glacial conditions might affect the redox-state of redox sensitive radionuclides if the redox-buffering capacity is depleted by the intruding oxygen. Taking the reduced sorption that is expected for glacial conditions into account, would lead to a higher release of radionuclides to the Baltic Sea during the high flux condition when an ice front passes above the repository. Neglecting this effect is pessimistic since the highest doses occur at later stages when releases occur to land and when reducing conditions can be expected to be re-established.

## 7.5.5 Routes to violation of the safety function avoid wells in direct vicinity of the repository

The uncertainties of importance for the status of the safety function *avoid wells in direct vicinity of the repository* are identified as described in the beginning of Section 7.5. The safety function *avoid wells in direct vicinity of the repository* is assessed with the aid of the safety performance indicators: *intrusion wells* and *wells downstream of the repository* (see Section 5.4).

The repository has been sited so that the probability of intrusion wells or wells downstream of the repository is very low, particularly during the first thousand years when the surface above the repository is being gradually lifted above sea level. In the case of drilling for water, it is conceivable that the time is even longer, which has proved to be the case for wells in the Forsmark area, most of



which have been drilled 1,000 years or more after the shoreline has passed (Kautsky 2001). It is also possible to drill under water, which is done routinely today at oil deposits, but the geological investigations performed before the siting of SFR, do not show any geological conditions appropriate to oil prospecting.

For the first 1,000 years after closure, the safety function *avoid inadvertent intrusion* is assumed to be intact. Under the assumptions made in the GIA simulation for the *global warming* and *early periglacial climate cases*, the duration until 75% of the area covering the repository is situated above the sea level is 600 years, and for a complete transformation to terrestrial conditions above the repository (SFR 1 and SFR 3) the duration is about 1,200 years. However, wells are not drilled as soon as land has emerged. Rather, a minimum height above sea level is needed in order to be able to drill and prevent sea water intrusion in the wells. For agricultural areas, it is assumed that wells are found in areas 1 m or more above sea level (m.a.s.l.) (Werner et al. 2013). The area above the repository will not be suitable for agricultural purposes due to the geological composition of the regolith (Sohlenius et al. 2013a), and for such areas, data from the national well database (SGU 2011) indicate that wells are not drilled so close to the shoreline. However, as future human habits cannot be predicted with certainty, no consideration is given to constraints that would arise from considering the current placement of wells, and wells are assumed to be possible when land has emerged to 1 m.a.s.l. or more. Hence more extreme variants of wells than the wells in the main scenario are studied in two less probable scenarios selected to study the impact of wells in direct vicinity of the repository; *wells downstream of the repository scenario* (see Section 7.6.7) and *intrusion wells scenario* (see Section 7.6.8).

## 7.6 Description of less probable scenarios

This section describes the less probable scenarios selected in the previous section. Based on the scenario-generating uncertainty regarding initial state, internal processes or external conditions, the probability of each scenario is assessed. Table 7-2 summarises the less probable scenarios and the safety functions that deviate from those of the main scenario.

### 7.6.1 High inventory scenario

The *high inventory scenario* is selected due to uncertainties in the initial inventory (measurement uncertainties, uncertainties in correlation factors and uncertainties in other methods used to calculate the best estimate inventory that is used in the main scenario) deviating from the status of the safety function *limited quantity of activity* in the main scenario.

**Table 7-2. Safety functions and selected less probable scenarios.**

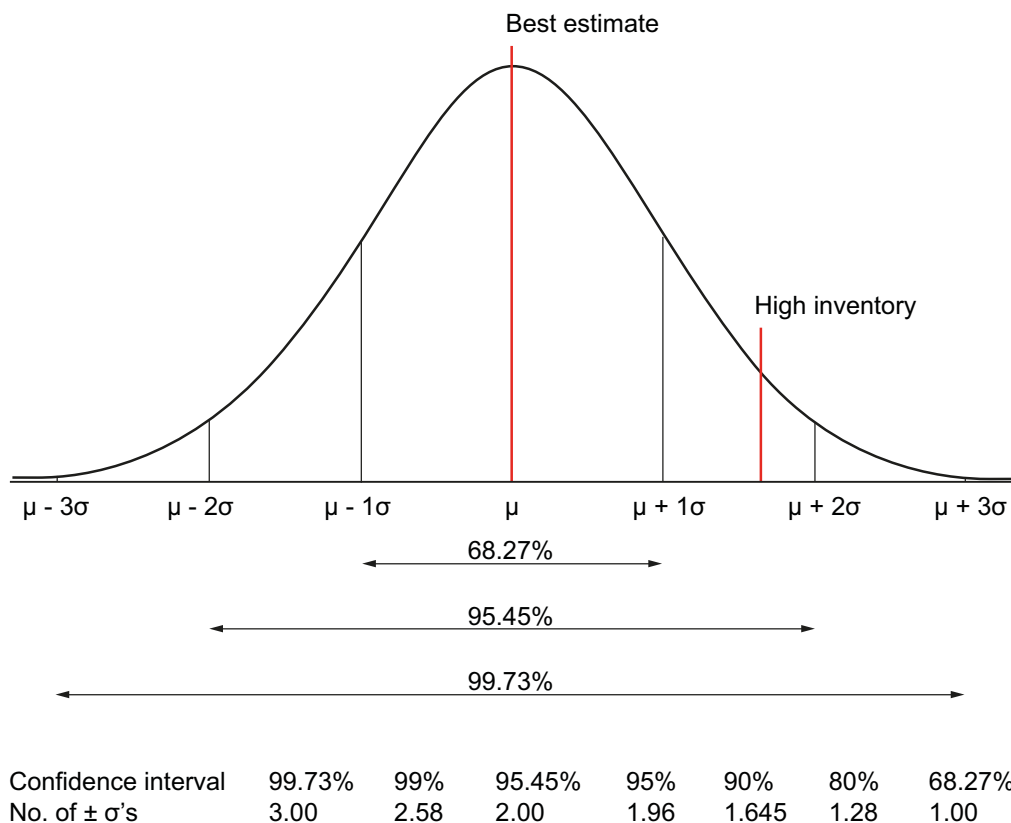
Safety function					Scenario
Limited quantity of activity	Low flow in bedrock	Low flow in waste vaults	Good retention	Avoid wells in the direct vicinity of the repository	
×					High inventory scenario (7.6.1)
	×				High flow in the bedrock scenario (7.6.2)
		×			Accelerated concrete degradation scenario (7.6.3)
		×			Bentonite degradation scenario (7.6.4)
	×	×			Earthquake scenario (7.6.5)
			×		High concentrations of complexing agents scenario (7.6.6)
				×	Wells downstream of the repository scenario (7.6.7)
				×	Intrusion wells scenario (7.6.8)

The safety function *limited quantity of activity* pertains to the activity of different radionuclides in each waste vault. In the main scenario, the inventory is based on the best estimate inventory reported in the inventory report (SKB 2013a) and in SKBdoc 1481419 for Mo-93. For NHB only data from the inventory report was used (SKB 2013a). However, for the estimation of the radiological consequences for non-human biota, only the data in the inventory report has been used. In the report, uncertainty estimates are also provided. Based on the best estimate of the inventory and associated uncertainties, an alternative inventory that corresponds to the 95th percentile of the distribution for each nuclide is derived. Figure 7-12 illustrates the two inventories in relation to a normal distribution.

The radionuclide inventory in the *high inventory scenario* is based on the best estimate but including uncertainties as presented in Table 4-7. The 95th percentile values for each radionuclide in each waste vault are used to illustrate the influence of a higher inventory. The probability of the entire inventory being above the 95th percentile is then much smaller than 5% as some nuclides could be above the 95th percentile and others below. Also, the inventory could be increased for some waste types but not for others. On the other hand, only very few nuclides give significant contributions to the total dose, which diminishes the significance of this effect. Nevertheless, using the 95th percentile values for each radionuclide and waste vault is very cautious and the probability of this scenario is assumed to be considerably less than 5%.

### 7.6.2 High flow in the bedrock scenario

The *high flow in the bedrock scenario* is based on the assumption that the safety function *low flow in bedrock* deviates from the main scenario due to uncertainties in the data used to describe the rock in the hydrogeological flow model.



**Figure 7-12.** Illustration of the two inventories “best estimate” and “high inventory”. The x-axis shows the number of standard deviations from the mean. The figure shows a normal distribution, but other distributions are possible.

The groundwater flow in the bedrock for the main scenario is described in Section 7.4.2. Due to the changed location of the shoreline, the boundary conditions will change and hence also the flow through the repository. As described in Section 7.4.1, this takes place mainly during the first 3,000 years. In the regional hydrogeological modelling (Odén et al. 2014), 17 bedrock cases have been included with different parameterisations of the deformation zones and fracture network. For the main scenario, a bedrock case that represents intermediate-flow (bedrock case 1) through all waste vaults was selected. In the *high flow in the bedrock scenario* the hydrogeological data for the bedrock case that represents high-flow (bedrock case 11) were used for the radionuclide transport calculations in the geosphere (these data are shown in Figure 7-4 to Figure 7-6).

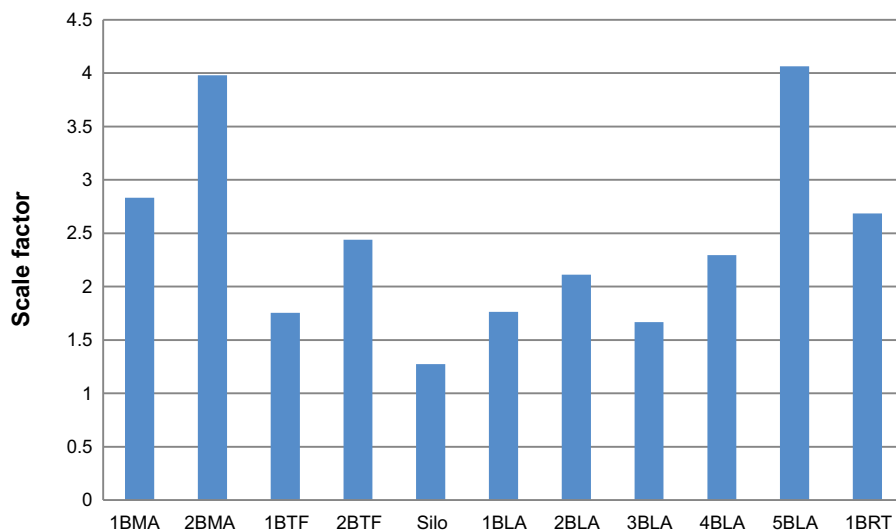
In the *high flow in the bedrock scenario* the detailed water flows inside the waste vaults were obtained by scaling the water flows in the main scenario. The scale factor for each vault is the maximum quotient between the cross flow in all bedrock cases and the cross flow in the intermediate-flow case used in the main scenario (all times  $\geq 2500$  AD), see Figure 7-13. This implies that some of these scale factors came from other cases than bedrock case 11. This choice of input data was done not to underestimate the release from any of the waste vaults, even though it is an unphysical set of input data.

All other data were the same as in the main scenario. No accelerated chemical degradation of the concrete barriers is assumed in this scenario as it is judged to be sufficiently cautiously treated in the main scenario and hence there are no changes of the partitioning coefficients for sorption. Combination of increased water flow and degradation processes are assessed in Section 7.8.

The use of maximum quotients implies that the flows for all waste vaults are not from the same bedrock case and hence the total aggregated flow through the waste vaults is higher than calculated in any of the bedrock cases and in this sense it is unphysical. The maximum quotient was chosen from 85 calculated cross flows for each vault (17 bedrock cases and 5 times  $\geq 2500$  AD). Regarding this the probability for the *high flow in the bedrock scenario* is assumed to be considerably less than 10%.

### 7.6.3 Accelerated concrete degradation scenario

The *accelerated concrete degradation scenario* is based on the assumption that the safety function *low flow in waste vaults* deviates from the main scenario due to uncertainties in concrete degradation processes.



**Figure 7-13.** Scale factors for near-field flows for each waste vault. The scale factor for each waste vault is the maximum quotient between the cross flow in all bedrock cases and the cross flow in the intermediate-flow case used in the main scenario (all times  $\geq 2500$  AD).

The reference evolution is based on an assessment of how different degradation processes can interact to degrade the concrete structures, which in turn is based on a synthesis of results from modelling of the different processes (Höglund 2014). The synthesis results in a description of the hydraulic conductivity of the concrete barriers for different degradation states and an estimate of when the concrete barriers pass from one degradation state to another. The main scenario is based on a probable estimate of the hydraulic conductivity for each degradation state plus a probable evolution of the degradation. The assumed hydraulic conductivity for each degradation state is associated with an uncertainty that gives both lower and higher hydraulic conductivity and an uncertainty regarding when the concrete barriers can be expected to pass from one degradation state to another. Associated changes of the diffusivities and porosities were also assessed by Höglund (2014).

The *accelerated concrete degradation scenario* assumes that the hydraulic conductivity of the concrete increases considerably earlier or to a greater extent than in the main scenario. This results in the following effects.

- Earlier or greater increase in the water flow through the waste vaults. The same repository hydrological calculation cases as in the main scenario are applicable, but apply to earlier time points.
- Earlier or greater increase in the diffusivities of the concrete barriers.
- Earlier or greater increase of the porosity.

The time points for these increases, coincide with the time steps for the increases of the hydraulic conductivities as shown in Figure 7-14. The data used are further described in the **Radionuclide transport report**.

All other data are the same as in the main scenario. No accelerated chemical degradation of the concrete barriers is assumed in this scenario as it is judged to be sufficiently cautiously treated in the main scenario and hence there are no changes of the partitioning coefficients for sorption. Combinations of increased water flow and degradation processes are assessed in Section 7.8.

The main scenario is based on realistic assumptions. However, care is taken to select slightly pessimistic rather than optimistic values. Therefore, the probability of the *accelerated concrete degradation scenario* occurring is low, and it is assumed to be considerably less than 10%.

#### 7.6.4 Bentonite degradation scenario

The *bentonite degradation scenario* is based on the assumption that the safety function *low flow in waste vaults* deviates from the main scenario due to uncertainties in the consequences of extensive periglacial conditions in combination with uncertainties in the sealing properties of the bentonite. This scenario can also be seen as representative for other bentonite degradation processes, for example montmorillonite alteration due to interactions with cementitious materials (Section 6.3.8).



**Figure 7-14.** Illustration of succession of the hydraulic conductivity of the concrete in the *accelerated concrete degradation scenario* where the three colours represents the degradation from moderately via severely to completely degraded concrete. Only the waste vaults where the concrete constitutes a main flow barrier are shown. The corresponding figure for the main scenario is Figure 7-8.

In the main scenario, the water flow in the silo is governed by the low hydraulic conductivity of the bentonite that is assumed to be maintained throughout the whole safety assessment period. It is judged that ice-lens formation influencing the bentonite hydraulic conductivity will not occur in the main scenario (Section 6.5.8). Ice-lens formation entails that water is drawn into the freezing bentonite, where it accumulates in ice layers. However, it is concluded in the reference evolution (Section 6.5.8), that it cannot be excluded that harmful ice-lens formation may occur in the silo bentonite during extensive permafrost events.

In the *bentonite degradation scenario* the effects of the ice-lens formation are assumed to be so large that the bentonite surrounding the silo will have a permanent increased hydraulic conductivity, which results in an increase in water flow. It is assumed that ice-lens formation occurs during the first permafrost period in the *early periglacial climate case*, i.e. in the period from 17,500 to 20,500 AD. The concrete is not assumed to freeze as the temperature needed for concrete to freeze is less than the temperature needed for bentonite to freeze. The size of the plugs implies that harmful ice-lens formation could not occur and hence the plugs are treated in the same way as in the main scenario.

As described in Section 6.5.5, a dedicated calculation case of the repository hydrology was set up to evaluate the influence of an ice-lens on the local silo flow (Abarca et al. 2013). In the model, the affected bentonite barrier was simulated by defining a ring of high permeability material, surrounding the silo concrete structure at mid-height. Results show an order of magnitude increase of the flow in the degraded volume, whereas the flow increase in the rest of the silo is moderate. The silo concrete structure limits the amount of water that can penetrate to the waste. The result from this calculation case was used in the radionuclide transport calculations for this scenario.

All other data for the repository, geosphere and biosphere were the same as for the *early periglacial variant* of the main scenario.

The main scenario is based on realistic assumptions. However, care is taken to select slightly pessimistic rather than optimistic values. Therefore, the probability of this scenario occurring is low, and is assumed to be considerably less than 10%.

### 7.6.5 Earthquake scenario

The *earthquake scenario* is based on the assumption that the safety function *low flow in waste vaults* deviates from the main scenario, as it cannot be ruled out that earthquakes damaging barriers will occur. The main scenario does not include consequences from earthquakes. Since the radiological effects caused by a damaged BMA structure were shown to be small in the SAR-08 assessment (SKB 2008a) this scenario only relates to the silo.

An analysis of the mechanical consequences of an earthquake for the integrity of the silo has been conducted (Georgiev 2013). Three different load spectra with annual probabilities of  $10^{-5}$ ,  $10^{-6}$  and  $10^{-7}$  were used (SKI 1992a, Appendix 1). The conclusion from the analysis in Georgiev (2013) is that damage to the silo concrete structure cannot be ruled out for a load spectrum with a probability of  $10^{-6}$ /year.

Up to the time of the postulated earthquake, radionuclide transport is assumed to occur in the same way as in the *global warming variant* of the main scenario. After the earthquake event, the concrete barriers in the silo are assumed to have failed, and the water flow increases. The increased water flow through the silo arising from concrete barrier damage was analysed in the safety analysis SAFE. With bentonite as a flow barrier, the increased flow of water is relatively small, in the order of  $1 \text{ m}^3/\text{year}$  (Holmén and Stigsson 2001).

The conditions in the geosphere are expected to be adversely affected, but such effects have not been quantified. In order not to underestimate the effects of an earthquake on the geosphere, no delay of radionuclides in the geosphere is assumed in this scenario.

The probability of damaged barriers due to earthquakes is  $10^{-6}$  /year.

### 7.6.6 High concentrations of complexing agents scenario

The *high concentrations of complexing agents scenario* is based on the assumption that the safety function *good retention* deviates from the main scenario due to uncertainties in the prognosis of the initial amounts of cellulose.

Complexing agents used at the nuclear facilities are present in the waste and can be also generated *in-situ* by the degradation of waste components such as cellulose. These may reduce sorption and enhance radionuclide transport. To a certain degree, effects of reduced sorption on radionuclide transport are included in the main scenario. The amount of different complexing agents and their sources (e.g. cellulose) in each type of the SFR waste package are presented in Keith-Roach et al. (2014). It is assumed that no secondary waste from the decommissioning waste containing high amounts of cellulose will be deposited in SFR. There are implemented guidelines for acceptable quantities of cellulose in the waste packages in the different waste vaults. There are also preliminary waste acceptance criteria (SKBdoc 1368638) that contain updated and new limits for the quantity of cellulose allowed in each waste vault. In addition, in the case of the waste to 2BMA, the amount of cellulose in each caisson will be limited to 2,600 kg. As regards other complexing agents besides cellulose, the predicted inventory is the inventory in SFR up to and including 2010. After 2010, SKB has restricted the use of strong organic complexing agents containing the following structural elements:

N-carboxylated diamines, e.g. EDTA,  
N-carboxylated triamines, e.g. DTPA,  
N-carboxylated amino acids, e.g. NTA,  
tricarboxylic acids, e.g. citric acid,  
 $\alpha$ -hydroxy carboxylic acids, e.g. gluconate.

This limits the future quantities of such compounds and thereby the uncertainties associated with the content of complexing agents in the future waste.

In the waste already deposited in SFR, the amount of cellulose and the concentration of other complexing agents exceed the levels at which sorption is expected to be affected (Keith-Roach et al. 2014). This is accounted for in the main scenario as a sorption reduction factor for the partitioning coefficients ( $K_d$  values). The amounts of cellulose are as in the prognosis (see Section 4.2.4), but not exceeding the preliminary waste acceptance criteria of 2,600 kg in each waste caisson in 2BMA.

The *high concentrations of complexing agents scenario* accounts for uncertainties in the amounts of complexing agents and cellulose in the repository by increasing the concrete sorption reduction factor used by a factor of 10. For all radionuclides that are potentially affected by complexing agents (i.e. all ions but C, Ca, Cl, I, Cs and Mo) this factor was chosen because reduction factors will increase by a factor of 10 with each 10-fold increase in the concentration of complexing agent above the indicated no-effect level in the **Data report**. In other words, with an indicated no-effect level of 1 mM complexing agent, sorption is expected to be reduced by a factor of 10 between 1 mM and 10 mM complexing agent, and by a factor of 10 between 10 mM and 100 mM complexing agent, etc. SKB maintains tight control on the deposition of complexing agents and cellulose. However, the final amount of these materials may exceed the current prognosis as a result of either the unavoidable use of certain materials at the nuclear power plants, or because a process intended to remove them is not suitable for all waste types. It is estimated that the complexing agents and cellulose deposited will, at most, exceed the amounts in the main scenario by a factor of 10. Concentration-dependent reduction factors are given in Table 7-11a to Table 7-11c in the **Data report**. The concentrations of complexing agents are given in a dedicated reference report (Keith-Roach et al. 2014). The resulting reduction factors, when taking into consideration a 10 times higher concentration than in the main scenario, are given in the **Input data report**, Section AMF number 75. The main scenario is based on realistic assumptions of the complexing agent and cellulose contents of both current and future wastes. However, care is taken to select slightly pessimistic rather than optimistic values. The preliminary waste acceptance criteria (SKBdoc 1368638) for SFR 3 do not permit cellulose quantities large enough for sorption to be affected due to ISA formation. This, and the careful control over the amounts deposited, mean that the probability of the *high concentrations of complexing agents scenario* occurring is low, and it is assumed to be considerably less than 10%.

### 7.6.7 Wells downstream of the repository scenario

The *wells downstream of the repository scenario* is based on the assumption that the safety function *avoid wells in the direct vicinity of the repository* deviates from the main scenario due to uncertainties in future habits.

Although the area in direct vicinity of the repository is not the most likely location for locating a well, as future human habits cannot be predicted with certainty, no consideration is given to constraints that would arise from considering the current placement of wells, and wells are assumed to be possible in the *wells downstream of the repository scenario*.

The location of SFR beneath the Baltic Sea is considered favourable in the sense that no wells are assumed to be drilled in the direct vicinity of the repository before shoreline displacement has reached the repository location, i.e. the first 1,000 years after closure. Despite the fact that the area in the vicinity of the repository may not be suitable for agriculture due to the geological composition of the overburden (Sohlenius et al. 2013a), and data from the national well database (SGU 2011) indicating that wells in areas without agriculture are not drilled so close to the shoreline, wells in the direct vicinity of the repository are assumed to be possible as soon as land has emerged to 1 metre above sea level.

Wells drilled into rock can be placed downstream of and close enough to the repository that they will be affected by a possible release from the repository. Wells placed downstream of the repository can attract a certain amount of water containing radionuclides from the repository. A so called *well interaction area* has been delineated, i.e. an area where there is a high density of flow pathways for radionuclides from the repository within a depth interval from 10 to 80 m below present-day sea level (a typical depth of a well drilled in rock in this area, from the rock surface to the bottom of the well). For the *well interaction area*, an estimate in the analysis is that a well can attract 10% of a radionuclide discharge from the repository (see Werner et al. 2013 for details). The concentration of radionuclides in the drinking water is calculated by dividing the amount of radionuclides that reach the well by the amount of water taken from the well (Werner et al. 2013).

To calculate the risk contribution from this scenario, it is necessary to take into account the probability of drilling in the *well interaction area*. This can be calculated by multiplying the number of wells per unit surface area in the Forsmark area with the area of the *well interaction area*. With a frequency of about 0.5 wells per km<sup>2</sup> and a *well interaction area* of 0.26 km<sup>2</sup>, the probability of a well for water supply being present in this area can be estimated as 13%.

### 7.6.8 Intrusion wells scenario

The *intrusion wells scenario* is based on the assumption that the safety function *avoid wells in the direct vicinity of the repository* deviates from the main scenario due to uncertainties in future habits.

Boreholes drilled for geothermal heat according to current technology are quite deep, often between 100 and 200 metres. Such drilling would penetrate the upper surface and possibly go straight through the repository, which would probably be noticed by the drilling personnel due to the change in the material being drilled. In such a case, it cannot be excluded that some of the waste material would be brought to the surface via drill cuttings. The effects of the cuttings being brought to the surface on drilling personnel and other persons in the area is describe in the *FHA scenario – drilling into the repository*.

Wells can also be drilled for water supply, which is covered in this scenario, the *intrusion wells scenario*. Based on well depth statistics, a well for drinking water is typically around 60 m deep in the Forsmark area (Werner et al. 2013), but conservatively, drinking water wells are assumed to penetrate the different waste vaults. Wells for drinking water can be drilled into the repository at the earliest when the shoreline has passed the repository and the place is high enough above sea level to avoid sea water intruding into the well. It is assumed that wells can be drilled into the repository when the shoreline has passed the entire top surface of the repository, at 3000 AD. If a well for drinking water is drilled into the repository, humans can be exposed by consuming the contaminated water, which, because of the limited dilution, can contain relatively high concentrations of each radionuclide. The probability of a well being drilled into the repository is however quite low. The probability can

be estimated by multiplying the well frequency in the region (approximately 0.5 wells per km<sup>2</sup>, based on current well frequencies, see Werner et al. 2013) with the foot print area of each waste vault. The probability of intrusion by wells will thus be  $4 \cdot 10^{-4}$  for the silo (footprint area around 800 m<sup>2</sup>) and around  $1.5 \cdot 10^{-3}$  for each of the other waste vaults (footprint area around 3,000 m<sup>2</sup>). This can be combined with the probability of a well for water supply being drilled deep enough to penetrate the repository. Based on well depth statistics (Werner et al. 2013), the probability can be estimated to be 50% that such a well enters SFR 1, and 20% that it enters SFR 3. This results in a probability of  $2 \cdot 10^{-4}$  for a well into the silo,  $8 \cdot 10^{-4}$  for a well into a waste vault in SFR 1 and  $3 \cdot 10^{-4}$  for a well into a waste vault in SFR 3.

## 7.7 Residual scenarios

Residual scenarios are analysed regardless of their probability, for example to study the function of individual barriers as described in Section 7.2.

### 7.7.1 Loss of barrier function scenario – no sorption in the repository

The aim of the loss of barrier function scenarios is to clarify how the different barriers contribute to the protective capability of the repository. The *loss of barrier function scenario – no sorption in the repository* illustrates the importance of sorption in the repository. This scenario is identical to the *global warming variant* of the main scenario, but with partitioning coefficients for sorption,  $K_d$  values, of 0 for all materials in the repository.

### 7.7.2 Loss of barrier function scenario – no sorption in the bedrock

The aim of the loss of barrier function scenarios is to clarify how the different barriers contribute to the protective capability of the repository. The *loss of barrier function scenario – no sorption in the bedrock* illustrates the importance of sorption in the rock. This scenario is identical to the *global warming variant* of the main scenario, but with partitioning coefficients for sorption,  $K_d$  values, of 0 in the bedrock.

### 7.7.3 Loss of barrier function scenario – high water flow in the repository

The aim of the loss of barrier function scenarios is to clarify how the different barriers contribute to the protective capability of the repository. The *loss of barrier function scenario – high water flow in the repository* illustrates the importance of the engineered barriers capability to limit the water flow through the part of the waste vaults containing waste. This scenario is identical to the *global warming variant* of the main scenario, but with data on the hydraulic conductivities in the repository that yields high flow through the waste parts of the vaults.

Repository water flows are calculated with the unrealistic pessimistic assumption that all concrete and bentonite (as well as macadam/crushed rock and sand/bentonite) in the waste vaults and in the plugs have a hydraulic conductivity of  $10^{-3}$  m/s (Abarca et al. 2013, Section 6.2.3). Porosities and diffusivities for degraded conditions were used. All other input data used in the repository models, the geosphere model and the biosphere model were identical with the *global warming variant* of the main scenario.

### 7.7.4 Changed repository redox conditions in SFR 1 scenario

Sorption of many elements – such as Np, Pa, Pu, Se, Tc, and U – is sensitive to the redox conditions. Sorption of these elements under oxidising conditions can differ considerably from sorption under reducing conditions. In the main scenario, the chemical conditions in the repository were assumed to be reducing. After the most recent SFR safety assessment SAR-08, the regulatory authority enjoined SKB to supplement the safety assessment with an assessment of the probability and consequences of changed redox conditions in SFR 1. After a model study of the probability of changed redox conditions (Duro et al. 2012), oxidising conditions were eliminated as a possibility. However, the *changed*



*repository redox conditions in SFR 1 scenario* is studied as a residual scenario in order to show the importance for long-term safety of maintained reducing conditions.

In this scenario, alternative sets of partitioning coefficients for sorption,  $K_d$  values, for cementitious materials, bentonite, sand-bentonite and macadam/crushed rock were used for these redox-sensitive elements.  $K_d$  values for Np(V), Pa(V), Se(VI), Tc(VII) and U(VI) were used. For plutonium the oxidation state with the lowest  $K_d$  values was chosen. Probability density functions were used for all  $K_d$  values in the radionuclide transport calculations.

Table 7-3 shows best estimate  $K_d$  values for hydrated cement paste for oxidising (this scenario) and reducing conditions (main scenario). As is evident from the table, sorption of all elements (except selenium) is lower under oxidising conditions. As in the main scenario, the  $K_d$  values for each cementitious material were obtained by using the  $K_d$  values for hydrated cement paste, the content of hydrated cement paste in each type of cementitious material and reduction factors for the influence from complexing agents.

Table 7-4 shows best estimate  $K_d$  values for bentonite for oxidising (this scenario) and reducing conditions (main scenario). Table 7-5 shows best estimate  $K_d$  values for macadam/crushed rock for oxidising (this scenario) and reducing conditions (main scenario). As in the main scenario,  $K_d$  values for sand/bentonite are obtained by using a weighted average from the  $K_d$  values selected for macadam/crushed rock and bentonite and the weight proportions of the two materials.

All other input data used in the repository models, the geosphere model and the biosphere model are identical to the *global warming variant* of the main scenario.

**Table 7-3.  $K_d$  values (best estimate) for hydrated cement paste for oxidising and reducing conditions (excerpt from Tables 7-7 to 7-10 in the Data report, upper and lower limits of the distributions are also given in the Data report).**

Element and oxidation state used in the changed repository redox conditions in SFR 1 scenario	$K_d$ [m <sup>3</sup> /kg]	Element and oxidation state used in the main scenario	$K_d$ [m <sup>3</sup> /kg]
Np(V)	0.1	Np(IV)	30
Pa(V)	10	Pa(IV)	30
Pu(V)	0.1	Pu(IV)	5 a)
Se(VI)	3·10 <sup>-3</sup> b)	Se(-II)	0
Tc(VII)	1·10 <sup>-3</sup>	Tc(IV)	3
U(VI)	2 c)	U(IV)	30

a) 30 in degradation state II, IIIa and IIIb.

b) 0 in degradation state IIIb.

c) 30 in degradation state II, IIIa and IIIb.

**Table 7-4.  $K_d$  values (best estimate) for bentonite for oxidising and reducing conditions (excerpt from Table 7-6 in the Data report, upper and lower limits of the distributions are also given in the Data report).**

Element and oxidation state used in the changed repository redox conditions in SFR 1 scenario	$K_d$ [m <sup>3</sup> /kg]	Element and oxidation state used in the main scenario	$K_d$ [m <sup>3</sup> /kg]
Np(V)	0.02	Np(IV)	63
Pa(IV/IV)	3	Pa(IV/IV)	3
Pu(V)	0.02	Pu(III)	61
Se(VI)	0	Se(-II)	0
Tc(VII)	0	Tc(IV)	63
U(VI)	3	U(IV)	63

**Table 7-5.  $K_d$  values (best estimate) for macadam/crushed rock for oxidising and reducing conditions (excerpt from Table 8-7 in the Data report, upper and lower limits of the distributions are also given in the Data report).**

Element and oxidation state used in the changed repository redox conditions in SFR 1 scenario	$K_d$ [m <sup>3</sup> /kg]	Element and oxidation state used in the main scenario	$K_d$ [m <sup>3</sup> /kg]
Np(V)	$4.1 \cdot 10^{-4}$	Np(IV)	$4.1 \cdot 10^{-4}$
Pa(V)	$5.9 \cdot 10^{-2}$	Pa(V)	$5.9 \cdot 10^{-2}$
Pu(III/IV)	$1.5 \cdot 10^{-5}$	Pu(III/IV)	$1.5 \cdot 10^{-5}$
Se(VI)	0	Se(-II)	0
Tc(VII)	0	Tc(IV)	$5.3 \cdot 10^{-2}$
U(VI)	$1.1 \cdot 10^{-4}$	U(IV)	$1.1 \cdot 10^{-4}$

### 7.7.5 Extended global warming scenario

The *extended global warming scenario* is included in the safety assessment in order to analyse the potential influence on the surface systems of the warmest and wettest climate conditions included in the set of climate cases included in SR-PSU (see Section 2.4.3). Therefore, the evolution of climate and climate-related conditions in Forsmark in the *extended global warming scenario* is defined by the evolution in the *extended global warming climate case* (see Section 6.2.1). This climate case describes a situation combining future low-amplitude variations in insolation with high carbon emissions in the current and next century, followed by a slow decrease in atmospheric CO<sub>2</sub> concentration. Together with the *global warming* and the *early periglacial* climate cases, this climate case represents the uncertainty range in future climate evolution associated with low, medium and high human carbon emissions (**Climate report** Chapter 4).

In this scenario, the current interglacial is extended to 100,000 years after present leading to temperate climate conditions in Forsmark for the complete 100,000 year assessment period. The warmest and wettest conditions analysed in SR-PSU occur during the initial thousands of years of this scenario. Further, this scenario includes the longest period of groundwater composition defined by meteoritic water infiltration, and the longest initial period of submerged conditions, analysed in SR-PSU.

In the *extended global warming scenario* the annual mean temperature reaches +10.7°C compared with approximately +5°C today and thus is more similar to the annual temperature that is found in southern Europe. The dominating trees in the Forsmark area today, Norway spruce, is assumed to be replaced by deciduous tree species like oak, elm, lime and ash. The concentration of carbon dioxide in the atmosphere is increased in this scenario, affecting the flux of carbon between primary producers and the atmosphere, and the productivity of crops is assumed to increase due to the changed climate conditions (**Biosphere synthesis report** Chapters 5 and 7).

### 7.7.6 Unclosed repository scenario

According to regulations (SSM 2008:21), it is necessary to define and analyse a scenario that illustrates the consequences of an unclosed repository that is not monitored. In this residual scenario, it is assumed that the repository, for some reason, is abandoned without being closed and sealed (as described in the Closure plan for SFR (SKBdoc 1358612)). This means that the pumping of groundwater that is performed continuously today ceases and that the repository becomes filled with water within a few years. In this scenario it is cautiously assumed that all waste already has been disposed and that the interim stored long-lived waste intended for disposal in SFL is present in the repository (SKBdoc 1412250).

SFR is not designed to be partially closed, all waste vaults are accessible throughout the operational time period and plugs will not be installed before it is decided to close the facility. During normal operations, some of the waste is grouted continuously, which means that all waste will not be accessible immediately in the case of an abandoned water-filled repository.

With time, concrete barriers and waste packaging will degrade and radionuclides will be released and dissolve in the water that has filled the repository. Since the sorption capacity that exists in the repository is expected to endure for a long time, the nuclides that are released will sorb to concrete, bentonite, the shotcrete in vaults and to other materials in the various waste vaults and the tunnel system.

If SFR is abandoned, it can be assumed that it will happen during the period when the repository is under water. Since the regional hydrogeological flow is small in relation to the water volume present in the repository, however, it will take a long time to replace the water in the repository and transport it out into the Baltic Sea. In other words, the water volume in the repository will be the same for a long period of time and the radionuclides that are dissolved are expected to remain in the repository in this scenario.

Since the groundwater that is pumped out of the repository today is relatively saline, it is not likely that the water volume that fills the repository will be used as a water supply as long as the repository is situated near the sea. On the other hand, it is not unreasonable to assume that the influx of meteoric water and limited remixing due to the difference in salinity and temperature could lead to the formation of a fresh water pool near the tunnel opening. Viewed over an extended period, fresh water could seep down into the repository and replace the saline water present there today with potable fresh water. As a result, a future population could conceivably consume contaminated water taken directly from the repository's opening. Based on these assumptions, a calculation case is presented for the *unclosed repository scenario* in Chapter 8.

### 7.7.7 Future human action scenarios

In accordance with the regulations in SSMFS 2008:37, future scenarios and events that can affect the long-term safety of the repository should be based on present-day conditions and habits. It cannot, therefore, be excluded that man, as occurs today, can drill for both water and geothermal heat, or perform certain types of geological investigations, and thereby come into contact with the waste. An exhaustive description of possible future activities that could affect the repository can be found in the **FHA report**. When selecting scenarios related to FHA, the aim was to select a manageable set of scenarios that covers the actions with the greatest potential to impair the repository performance and/or lead to the most severe radiological consequences to humans. Accordingly, the scenario selection is not intended to identify the reason for the FHA but to identify the potential consequences. Three different FHA scenarios were set up, 1) Drilling into the repository, 2) Water management, and 3) Underground constructions.

#### ***FHA scenario – drilling into the repository***

Drilling (FEP FHA11) is considered to be a credible action that may lead to direct intrusion into the repository; it is also judged as being inadvertent, technically possible and practically feasible, plausible, and conceivable in the societal context. The premise for this scenario is that the technology to drill to repository depth exists (as detailed in Section 4.3.11 in the **FHA report**), that the knowledge of the location and purpose of the repository is lost, and that the intruders do not initially recognise the radioactive nature of drilling material with which they may come into contact.

The main assumption for the drilling scenario is that the borehole directly intersects the repository and brings contaminated materials up to the surface. However, in reality, it is likely that any contaminated material derived from the components of the SFR repository will be discovered and the drilling stopped for further investigation which could lead to recognition of the purpose of the underground repository (SFR). Material brought to the surface may give rise to exposure of drilling crew workers who might examine the drilled material before its hazardous nature is recognised. In addition, the contaminated drilling detritus is assumed to be disposed of in a near-by landfill. This landfill is assumed also to be subject to human utilisation as a construction site or as a garden plot, without people having understanding of the potential radiological hazard. To maximise the potential dose consequences to humans, it is assumed that the borehole penetrates disposed radioactive waste packages. The borehole may also be used for water supply, a scenario which is included in the *intrusion wells scenario* (see Section 7.6.8).

For the initial period after closure, the SFR will still be situated below the sea, and the shoreline displacement is not expected to raise the land surface above SFR above the shoreline until about year 3000 AD (the same assumption as in the *intrusion wells scenario* in Section 7.6.8). Intrusion by drilling before the footprint repository is situated above the shoreline is deemed highly unlikely and therefore drilling is not assumed to happen before the year 3000 AD in this scenario.

### **FHA scenario – water management**

Water management is considered to be a credible action that may lead to altered hydrogeological fluxes at repository depth. Water management activities may locally affect hydraulic gradients. The impacts of water management activities on the capacity of the rock to provide favourable hydrological and transport conditions for the repository functioning are judged to be in most cases small, although large-scale construction activities affecting hydrology may have an effect at repository depth. The one action considered here is removal or modifications to the SFR pier.

Removal of the SFR pier is not strictly a water management activity but may lead to altered hydrogeological fluxes. The SFR pier is constructed from coarse, highly permeable materials (sand, gravel, and blocks). The pier is constructed on a natural topographic ridge. Groundwater levels in stand pipes demonstrate that the current groundwater table is very close to sea level. There is no data support indicating that the future groundwater level in the SFR pier should rise significantly above sea level, or the natural ridge. Therefore the removal or levelling of highly permeable filling masses of the SFR pier is not expected to have a significant effect on the local flow pattern at SFR. The significance of SFR pier groundwater levels for performance measures in SR-PSU is demonstrated by comparing two hydrological model representations (SKBdoc 1395215):

- High SFR pier groundwater level (pessimistic): the SFR pier is modelled to hold groundwater above future sea level and its hydraulic contact with the underlying bedrock is assumed to be unconstrained.
- Low SFR pier groundwater level (realistic): the SFR pier is modelled to hold a low groundwater level and its hydraulic contact to the underlying bedrock is assumed to be restricted by the existence of natural sediments.

The hydrological modelling showed somewhat altered hydrological water flows between the two cases. However, the difference was limited and, therefore, the effects of altered hydrological flow due to this and other water management actions can be assumed to be addressed by the *high flow in the bedrock scenario* (Section 7.6.2) and no specific FHA calculation case is set up for this FHA scenario.

### **FHA scenario – underground constructions**

There are plausible future actions related to underground constructions that may lead to altered hydrological fluxes. An underground construction is not assumed to directly intersect the repository since the repository would in such a case be recognised by exploratory drilling. However, a rock cavern near the repository could affect the hydraulic gradient and possibly also create new potential transport pathways. If the rock cavern is kept dry, water fluxes and conditions for transport of substances with the groundwater will be affected. Abandoned rock caverns, tunnels, shafts and boreholes are potential transport pathways for undesirable substances to and from the repository. A rock cavern may also affect the capability of the geosphere to provide chemically favourable conditions. For example, during operation of a sub-surface facility close to the repository, salinity can increase at repository depth. The closer to the repository the rock cavern is located, the more the repository would be affected. The effects of either 1) a road or rail tunnel in the vicinity of the repository or 2) a mine in the vicinity of the Forsmark site, are qualitatively examined in the **FHA report**.

#### **Road or tunnel in the vicinity of the repository**

The impact on the repository of the construction of a tunnel in the vicinity of the repository will depend on the location, depth and size of the tunnel. A tunnel west of the Singö deformation zone would not influence the SFR repository negatively as the hydraulic gradient is from west to east and a regional deformation zone is in between. A nearby tunnel north, south or east of the repository could change the direction and magnitude of the hydraulic gradient and hence result in somewhat larger flow through the waste vaults. However, grouting would considerably limit the impact of the tunnel on the hydrogeology in the surrounding rock. Thus, it is evident that a tunnel in the vicinity of Forsmark is likely not to have a negative effect on the SFR repository. Nevertheless, it cannot be excluded that a tunnel south or east of the repository would affect the hydraulic gradient. The effects on hydrological flow due to a tunnel construction can be assumed to be addressed by the *high flow in the bedrock scenario* (Section 7.6.2) and this FHA scenario is not further analysed.

### **Mine in the vicinity of the repository**

The ore potential at Forsmark has been analysed within the site investigations for a repository for spent fuel. In an area south-west of the Forsmark site a felsitic to intermediate metavolcanic rock, judged to have a potential for iron oxide mineralisation, has been identified (Lindroos et al. 2004). The mineral deposits have been assessed to be of no economic value. Nevertheless, as this judgement may be revised in the future due to economic reasons, the potential exploitation of this mineralisation is addressed. If a mine were to be constructed in the vicinity of the SFR repository, it may be assumed that the greatest influence on the repository would occur if the construction took place in close proximity to the repository. For the planned repository for spent nuclear fuel it was concluded that the repository and a hypothetical mine in the potential area for mineralisation would be on the order of 3 km apart and that this is too far away to influence the repository (SKB 2010d). The distance between SFR and the potential ores site is even larger and it can be assumed that the potential influence on the repository from a future mine would be insignificant.

### **7.7.8 Glaciation and post-glacial conditions scenario**

The *glaciation and post-glacial conditions scenario* is included in the safety assessment in order to cover the uncertainty in the timing of the next Northern Hemisphere glaciation (**Climate report** Section 3.3.5) and to study the radiological consequences, from SFR, of a glaciation in the Forsmark region.

Current scientific understanding suggests that the onset of the next glaciation will not occur in the next 50,000, or perhaps even the next 100,000 years. It can thus not be ruled out that a glaciation will occur in South-Central Sweden during the latter part of the 100,000 year assessment time (see Section 3.5.1). The load of an ice-sheet is expected to significantly influence the SFR repository. A detailed analysis of the evolution of the repository under glacial and post-glacial conditions has not been performed within SR-PSU. Rather, the *glaciation and post-glacial conditions scenario* is defined based on cautiously simplified assumptions with respect to the impact of the glacial and post-glacial conditions on the repository.

#### **External conditions**

The *glaciation and post-glacial conditions scenario* is based on the ice-sheet development as described in the *Weichselian glacial cycle climate case* (**Climate report** Section 4.4). The *Weichselian glacial cycle climate case* is defined as a repetition of conditions reconstructed for the last ~120,000-year-long glacial cycle. This climate case is used *specifically* to handle uncertainty concerning the potential for glaciation in the coming 100,000 years, and *not* for analysis of the first potential period with periglacial conditions and permafrost. The latter case is instead covered in the dedicated *early periglacial variant* of the main scenario (Section 7.4.1).

The *Weichselian glacial cycle climate case* includes two periods with glacial climate domain, i.e. with an ice sheet located above the repository in Forsmark (see Figure 7-15). The first of these periods extends for 8,600 years and occurs between 59,600 and 68,200 AD. This glacial period is chosen for the evaluation of the evolution of the repository and its environs in the *glaciation and post-glacial conditions scenario*. In accordance with the evolution in the *Weichselian glacial cycle climate case*, an ice sheet is assumed above SFR from 59,600 to 68,200 AD, in this scenario. This period is followed by a period of submerged conditions from 68,200 to 76,200 AD, in accordance with the climate case. During the remaining part of the assessment period temperate climate conditions are assumed. The latter assumption is not in accordance with the climate evolution in the *Weichselian glacial cycle climate case*, which consists of a succession of periglacial, temperate and glacial climate domain for this period. However, since doses are expected to be higher during temperate compared to periglacial conditions (see the **Biosphere synthesis report** Section 10.6) this assumption is regarded to be cautious and it also simplifies the evaluation and the discussion of the consequences of a glaciation.

Based on the *Weichselian glacial cycle climate case*, continuous permafrost at repository depth is assumed to exist prior to the ice sheet advance over the site at 59,600 AD. Thus, no groundwater flow in the waste vaults is assumed during the passage of the advancing ice front over the repository. Assuming an initial period with permafrost and frozen bedrock conditions down to repository depth

is cautious when it comes to the amount of remaining radionuclides in the repository after glaciation, since a shorter period with thawed bedrock conditions results in less transport of radionuclides from the repository to the Baltic Sea.

During the first half of the glaciated period the ice sheet is cold-based over the repository, whereas during the last half of the glaciated period the repository is covered by warm-based ice (Figure 7-15). At the transition to warm-based conditions, the frozen bedrock is assumed to thaw (see e.g. SKB 2010c Figure 4-34) and remain unfrozen until the ice sheet withdraws at 68,200 AD, in accordance with the reconstructed conditions in this climate case.

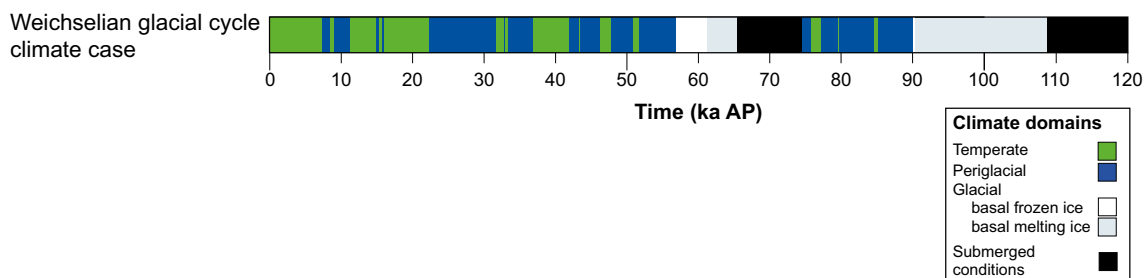
### Hydrogeology

In order to evaluate changes in the groundwater flow at SFR repository depth, results obtained for the planned repository for spent nuclear fuel, are used (Vidstrand et al. 2010 e.g. Section 6.3, Vidstrand et al. 2013, 2014). Changes in the groundwater flow relative to temperate terrestrial conditions are found to be similar at SFR repository depth and at the depth of the planned repository for spent nuclear fuel (Vidstrand et al. 2014, SKBdoc 1462415). During periods of glacial conditions, the gradient of the ice sheet surface determines the groundwater flow. At the Forsmark site, this means significantly increased flow during ice sheet margin passages compared to non-glacial conditions (Vidstrand et al. 2010 e.g. Figures 6-7 and 6-8, Vidstrand et al. 2013, 2014).

Only radionuclides that remain in the repository and its environs when the surface above SFR becomes land will contribute to the highest potential doses to humans. The first glacial period of the *Weichselian glacial cycle climate case* which was chosen to evaluate this scenario is shorter and involves a weaker increase in the groundwater flow during ice-sheet margin retreat, than the following glacial period (which is 18,700 years long). Thus, less radionuclides will be transported out of the repository to the Baltic Sea. Therefore, this is deemed to be a cautious choice of glacial period.

Changes in groundwater flow for the specific reconstructed glacial period were simulated by Vidstrand et al. (2010, 2013, 2014). These results were used to estimate the groundwater flow for various parts of the glacial period. In these simulations, a steep ice sheet profile, and an associated large increase in groundwater flow, was assumed during ice sheet advance.

A flatter profile, and less increase in groundwater flow, was assumed during the ice sheet retreat (Vidstrand et al. 2013 e.g. Figure 6). These assumptions are in accordance with the Weichselian ice sheet reconstruction (**Climate report** Sections 2.3 and 4.4, SKB 2010c Appendix 2). During peak glaciation, the ice sheet gradients are very low, similar to the regional gradients in the Forsmark area during temperate terrestrial conditions. The evolution of the ground water flow was simplified based on the results of Vidstrand et al. (2013 e.g. Figure 6), Vidstrand et al. (2010 e.g. Figure 6-18), and gradients of the ice sheet surface for the Weichselian ice sheet reconstruction (**Climate report** Sections 2.3 and 4.4, SKB 2010c Appendix 2), as summarised in Table 7-6.



**Figure 7-15.** Evolution of climate-related conditions at Forsmark as a succession of climate domains and submerged periods for the Weichselian glacial cycle climate case. Time is given in relation to the present day, where 0 ka AP corresponds to 2000 AD. The figure is identical to Figure 4-18 in the **Climate report**.

**Table 7-6. Summary of the *glaciation and post-glacial conditions scenario*.**

Time period	Climate domain above repository	Prevailing conditions at repository depth	Ice sheet surface gradients	Duration of period (years)	Groundwater flow as compared to temperate terrestrial conditions
Ice sheet advance over Forsmark 59,600–61,600 AD	Glacial	Frozen bedrock and no groundwater flow	High	2,000	No flow at repository depth
Continued ice sheet growth 61,600–63,900 AD	Glacial	Frozen bedrock and no groundwater flow	Intermediate to low	2,300	No flow at repository depth
Thawed bedrock conditions 63,900–66,200 AD	Glacial	Thawed bedrock with groundwater flow	Very low (comparable to non-glaciated conditions)	2,300	1x
Ice-sheet deglaciation 66,200–67,200 AD	Glacial	Thawed bedrock with groundwater flow	Low	1,000	2x
Deglaciation of the Forsmark site 67,200–68,200 AD	Glacial	Thawed bedrock with groundwater flow	Intermediate	1,000	3x
Submerged conditions above repository 68,200–76,200 AD	Temperate climate domain, but submerged conditions	Thawed bedrock with groundwater flow	–	8,000	0.2x
Terrestrial conditions above repository 76,200–102,000 AD	Temperate	Thawed bedrock with groundwater flow	–	25,800	1x

In the *Weichselian glacial cycle climate case*, the period of ice-sheet retreat in northern Europe starts ~65,000 AD (SKB 2010c). The ice-sheet deglaciation reaches Forsmark at ~68,200 AD. The period from ~63,900 AD, when the bedrock has thawed, until the deglaciation of Forsmark at ~68,200 AD, has been divided into three parts with respect to groundwater flow based on Vidstrand et al. (2013 e.g. Figure 6). During the period 63,900–66,200 AD, when the ice sheet margin is far from Forsmark, the groundwater flow at repository depth is similar to temperate terrestrial conditions. During the period 66,200–67,200 AD, when the ice sheet margin is approaching Forsmark, the groundwater flow at repository depth is about two times temperate terrestrial conditions. During the period 67,200–68,200 AD, when the ice sheet margin is closing in on Forsmark, the groundwater flow at repository depth is about three times temperate terrestrial conditions. When the ice margin has passed over SFR, the site is submerged and the ground water flow is about 0.2 times the temperate terrestrial conditions (Vidstrand et al. 2010 e.g. Figure 6-18).

### **Repository evolution and radionuclide transport**

The structural integrity of the waste vaults cannot be expected to remain intact after a glaciation. This is assumed to result in a situation equivalent to that assumed in the *loss of barrier function scenario – high water flow in the repository* (Section 7.7.9), in which the engineered barriers capability to limit the water flow through the part of the waste vaults containing waste is assumed to be negligible. The materials in the engineered barriers are assumed to remain in SFR, and therefore sorption is assumed to be the same as in the *global warming variant* of the main scenario.

No transport of radionuclides out of the repository is assumed to occur during the period prior to the glacial period. In the main scenario, the outflow period has cautiously been overestimated, in order not to underestimate the consequences. In the *glaciation and post-glacial conditions scenario*, on the other hand, transport of radionuclides out of the repository during periods prior to the glacial period would diminish the consequences of glaciation. Therefore, it was cautiously assumed that no outflow occurs prior to the glaciation. Thus, the radionuclide inventory in SFR at the starting point of this scenario is determined by the inventory at closure and the radioactive decay and in-growth that has occurred prior to the glacial period.

During the latter part of the glacial period, when the bedrock is unfrozen, radionuclides are transported from SFR to the Baltic Sea. Due to the isostatic depression of the bedrock at SFR, a substantial water depth is assumed in this part of the Baltic Sea and therefore the radionuclides are assumed to spread over a larger part of the Baltic resulting in a negligible accumulation of radionuclides in the sediments in the Forsmark area. During the 8,000 year submerged period following the glacial period, the isostatic rebound slowly results in a lowering of the water depth in this part of the Baltic Sea. Radionuclides transported out of SFR to the Baltic Sea during the submerged period are therefore cautiously assumed to accumulate in the sediments above SFR. The subsequent temperate period is cautiously assumed to last until the end of the 100,000 years assessment period and the biosphere is here modelled as for temperate periods in the main scenario.

## 7.8 Scenario combinations

In addition to the less probable scenarios, combinations of the less probable scenarios are clearly possible. However, given that the less probable scenarios are independent from each other, i.e. that there are different underlying uncertainties behind each scenario, the probability for a scenario combination equals the product of the probabilities for the combined scenarios and is naturally lower than the probability for each scenario independently.

In order to illustrate this, two scenario combinations have been generated, see Table 7-7. *Scenario combination 1* combines the *high flow in the bedrock scenario* with the *accelerated concrete degradation scenario*. While the *high flow in the bedrock scenario* is based on uncertainties in the data used to describe the rock in the hydrogeological flow model the *accelerated concrete degradation scenario* is based on uncertainties in, mainly the rate of, concrete degradation processes. Although it could be argued that the degradation process of concrete could be coupled with water flow other uncertainties exist, as seen in the scenario description and reported in Chapter 6. Therefore, the uncertainties generating these two scenarios are regarded as independent.

*Scenario combination 2* combines the *high flow in the bedrock scenario* with the *high concentrations of complexing agents scenario*. While the *high flow in the bedrock scenario* is based on uncertainties in the data used to describe the rock in the hydrogeological flow model the *high concentrations of complexing agents scenario* is based on uncertainties in the amounts of complexing agents and cellulose disposed in the repository. The uncertainties generating these two scenarios are regarded as independent.

Different scenario combinations, than the above, are clearly possible, as well as scenario combinations including more than two less probable scenarios. With independent scenario generating uncertainties, the probability for scenario combinations of three or more combined scenarios is very low. The two selected scenario combinations are judged to be sufficient to shed light on the issue of scenario combinations.

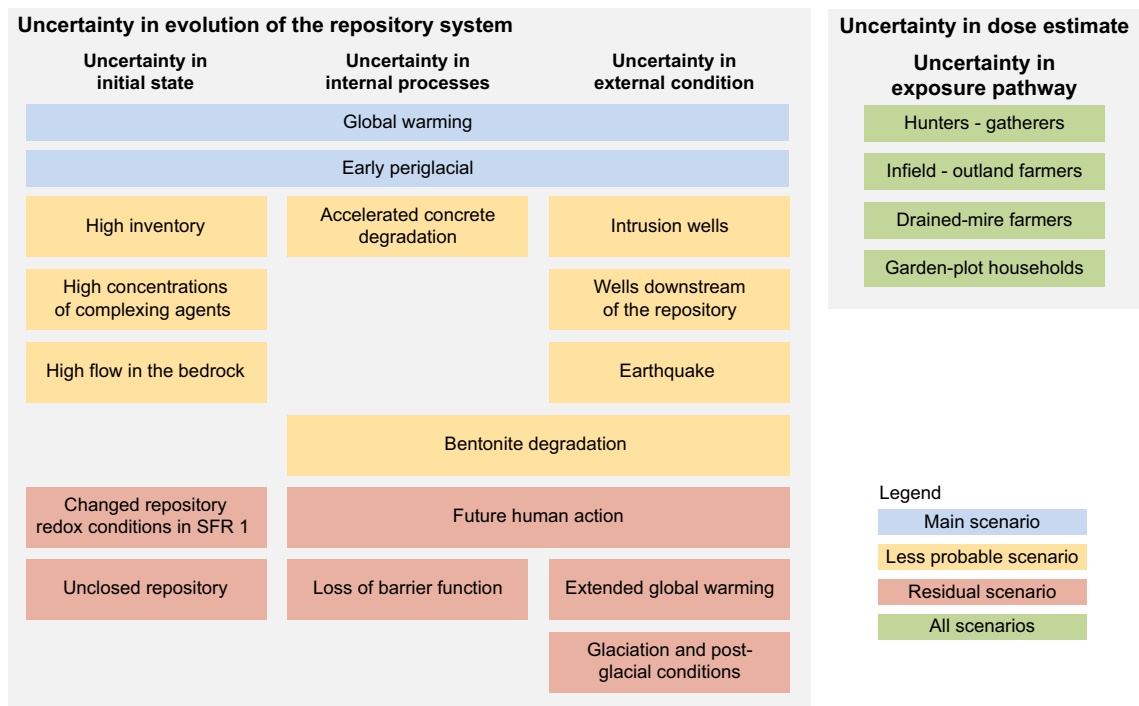
## 7.9 Summary of selected scenarios

The scenarios are selected to assess the uncertainties in the evolution of the repository system. Figure 7-16 shows which type of uncertainties (initial state, internal processes and external conditions) that are evaluated in the selected scenarios. Table 7-8 summarises the selected scenarios and their probabilities.



**Table 7-7. Less probable scenarios and scenario combinations.**

Scenario	Scenario based on	Scenario combinations	
		Combination 1	Combination 2
High inventory scenario (Section 7.6.1)	Uncertainties in the initial inventory (initial state)		
High flow in the bedrock scenario (Section 7.6.2)	Uncertainties in the data used to describe the rock in the hydrogeological flow model (initial state)	×	×
Accelerated concrete degradation scenario (Section 7.6.3)	Uncertainties in, mainly the rate of, concrete degradation processes (internal processes)	×	
Bentonite degradation scenario (Section 7.6.4)	Uncertainties in the consequences of extensive periglacial conditions (external conditions) in combination with uncertainties in the sealing properties of the bentonite (internal processes)		
Earthquake scenario (Section 7.6.5)	Uncertainties in future evolution of the site (external conditions)		
High concentrations of complexing agents scenario (Section 7.6.6)	Uncertainties in the amounts of complexing agents and cellulose in the repository (initial state)		×
Wells downstream of the repository scenario (Section 7.6.7)	Uncertainties in future habits (external conditions)		
Intrusion wells scenario (Section 7.6.8)	Uncertainties in future habits (external conditions)		



**Figure 7-16.** Illustration of how uncertainties are handled in the scenarios.

**Table 7-8. Summary of scenarios with probabilities and categories.**

Scenario (section where it is described is given within parenthesis)	Probability	Category
Global warming climate variant (Section 7.4)	1	Main scenario
Early periglacial climate variant (Section 7.4)	1	
High inventory scenario (Section 7.6.1)	< 0.05	Less probable scenarios
High flow in the bedrock scenario (Section 7.6.2)	< 0.1	
Accelerated concrete degradation scenario (Section 7.6.3)	< 0.1	
Bentonite degradation scenario (Section 7.6.4)	< 0.1	
Earthquake scenario (Section 7.5.5)	$10^{-6}$ /year	
High concentrations of complexing agents scenario (Section 7.6.6)	< 0.1	
Wells downstream of the repository scenario (Section 7.6.7)	0.13	
Intrusion wells scenario (Section 7.6.8)	$2 \cdot 10^{-4}$	
	Each waste vault in SFR 1	$8 \cdot 10^{-4}$
	Each waste vault in SFR 3	$3 \cdot 10^{-4}$
Loss of barrier function scenario – no sorption in the repository (Section 7.7.1)		Residual scenarios
Loss of barrier function scenario – no sorption in the bedrock (Section 7.7.2)		
Loss of barrier function scenario – high water flow (Section 7.7.3)		
Changed repository redox conditions in SFR 1 scenario (Section 7.7.4)		
Extended global warming scenario (Section 7.7.5)		
Unclosed repository scenario (Section 7.7.6)		
Future human action scenarios (Section 7.7.7)		
Glaciation and post-glacial conditions scenario (Section 7.7.8)		
Scenario combination 1 (Section 7.8)	< 0.1 · 0.1	Scenario combinations
Scenario combination 2 (Section 7.8)	< 0.1 · 0.1	

## 8 Description of calculation cases

### 8.1 Introduction

This chapter presents the methodology for radionuclide transport and dose calculations. The chapter begins, in Section 8.2, with a brief description of the overall modelling approach of the applied chain of models and its members for the repository (near-field), rock/geosphere (far-field) and surface system (biosphere).

In the following sections, a number of calculation cases are defined which are based on the scenarios presented in Chapter 7, see Figure 8-1. Calculation cases relating to the main and less probable scenarios are presented in Sections 8.3 and 8.4 while the calculation cases for residual scenarios appear in Section 8.5 and for scenario combinations in Section 8.6. Finally, all calculation cases are summarised in Section 8.7. In the **Radionuclide transport report**, a more detailed description is given.

A number of assumptions for the near-field, far-field and biosphere have been made to calculate potential radiological consequences. The assumptions made for each calculation case are presented below. The sub-model for the assessment of the biosphere in a calculation case is defined by an assigned biosphere calculation case (BCC), which conforms to the specific boundary conditions assumed for the calculation case. The derivation of the biosphere calculation cases is described in the **Biosphere synthesis report** and Sætre et al. (2013) for details.

### 8.2 Modelling approach

#### 8.2.1 Model chain and data flow

Figure 8-2 shows conceptually the models and data used in the radionuclide transport and dose calculations. The model chain consists of models for the repository (waste and engineered barrier system) represented by the *near-field*, for the geosphere (geological barrier system) represented by the *far-field* and the surface systems represented by the *biosphere*.

In most of former long-term safety assessments at SKB, the biosphere model was decoupled from the repository system (represented by near-field and far-field) by means of separately calculated dose conversion coefficients, which were to be applied on releases from the far-field for the calculation of doses. In the present assessment, transient releases from the far-field are however fed directly into the biosphere model. This enables the dose calculation to take the release history and the evolution of the biosphere system into account.

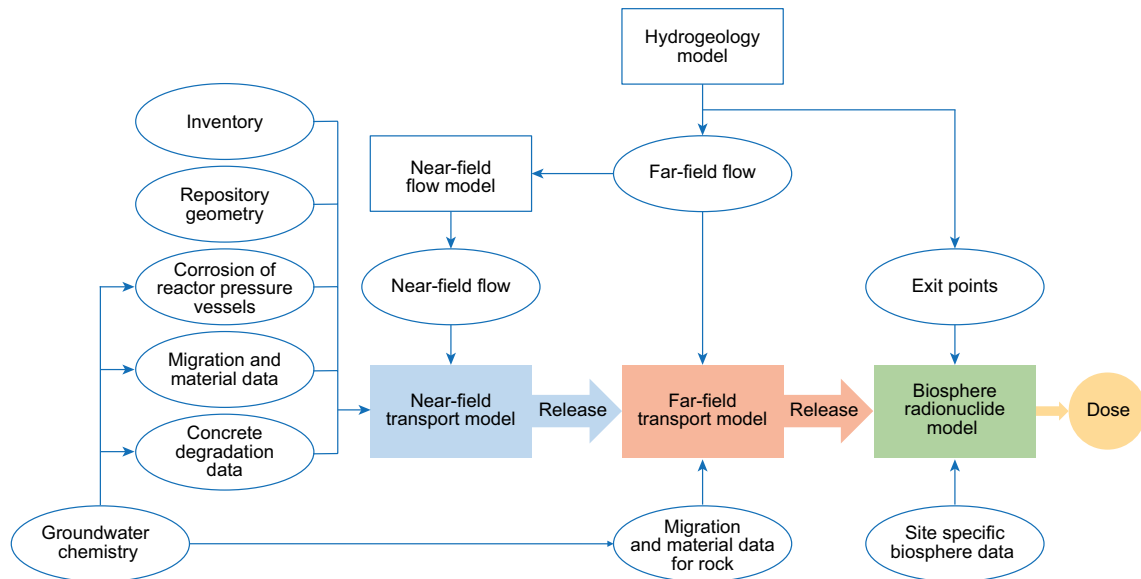
In scenarios which are undisturbed by human action (i.e. drilling) the releases from the far-field (or from the near-field after an earthquake event) are discharged into a single biosphere object (157\_2). From this biosphere object the releases are spread to the other biosphere objects. One exception is the main scenario variant *early periglacial calculation case*, where radionuclides only are released into unfrozen areas (taliks) in the frozen landscape. In this calculation case the biosphere objects 157-1 and 114 represent taliks. Uncertainties of the location of exit points with regard to the estimation of radiological consequences are addressed in the **Biosphere synthesis report**.

Calculation cases for less probable scenarios are particularly implemented by altered parameterisations of water flows, of evolution of the repository system (i.e. time thresholds determining periods of climate domains, landscape development and degradation of technical barriers) or of  $K_d$  values. These cases refer to uncertainties of the evolution of the repository system (scenarios, processes). One case refers to the initial state of the system addressing the uncertainty of the radionuclide inventory.

In some calculation cases the model chain is altered by substituting members or changing the interface between them. In the case of drilled well scenarios or a post-earthquake-event situation, the far-field model is bypassed and the near-field releases are directly fed into the biosphere model. For the exposure of operational personnel in calculation cases addressing FHA simplified exposure

Climate case	Scenario	Calculation case	
Global warming	<b>Main scenario</b>		
	Global warming	CCM_GW CCM_TR CCM_CD	
	Early periglacial	CCM_EP	
Early periglacial	<b>Less probable scenarios</b>		
	High inventory	CCL_IH	
	High flow in the bedrock	CCL_FH	
	Accelerated concrete degradation	CCL_BC	
	Weichselian glacial cycle	Bentonite degradation	CCL_BB
		Earthquake	CCL_EQ
	Extended global warming	High concentrations of complexing agents	CCL_CA
		Wells downstream of the repository	CCL_WD
Extended global warming	Intrusion wells	CCL_WI	
	<b>Residual scenarios</b>		
	Loss of barrier function	CCR_B1 CCR_B2 CCR_B3	
	Changed redox conditions in SFR 1	CCR_RX	
	Extended global warming	CCR_EX	
	Unclosed repository	CCR_UR	
	Future human action	CCFHA1 CCFHA2 CCFHA3	
	Glaciation and post-glaciation condition	CCR_GC	
	<b>Scenario combinations</b>		
	Scenario combination 1	CCC_SC1	
Scenario combination 2	CCC_SC2		
CCM_GW Global warming CCM_TR Timing of releases CCM_CD Collective dose CCM_EP Early periglacial		CCR_B1 Loss of barrier funct. – no sorption in the repository CCR_B2 Loss of barrier funct. – no sorption in the bedrock CCR_B3 Loss of barrier funct. – high water flow in the repository CCR_RX Changed repository redox conditions in SFR 1 CCR_EX Extended global warming CCR_UR Unclosed repository CCFHA1 FHA – Expos. of on-site crew during a drilling event CCFHA2 FHA – Expos. during construction on drill. detritus landfill CCFHA3 FHA – Expos. due to cultivation on drill. detritus landfill CCR_GC Glacial and post-glacial conditions	
CCL_IH High inventory CCL_FH High flow in the bedrock CCL_BC Accelerated concrete degradation CCL_BB Bentonite degradation CCL_EQ Earthquake CCL_CA High conc. of complexing agents CCL_WD Wells downstream of the repository CCL_WI Intrusion wells		CCC_SC1 Scenario combination 1 CCC_SC2 Scenario combination 2	

Figure 8-1. Relationship between climate cases, scenarios and calculation cases.



**Figure 8-2.** Outline of models and data for the radionuclide transport. The description of the model chain, data flow and related connections are simplified in the figure. A detailed description of the models is found in the **Radionuclide transport report**, the couplings are described in greater detail in Table F-11 Annex F and Annex G.

models are applied based on available data describing the specific exposure situation; also the near-field models are simplified in these calculation cases (**FHA report**).

Parameters describing the flow of water in the near-field, the degradation of the barrier system and the biosphere evolution under the impact of changing external conditions (climate and landscape development) are treated in a deterministic way, i.e. features can change in simulated time but in a prescribed way.

The flow in the far-field is treated differently. The hydrogeological modelling provides for relevant sets of external conditions a large number of alternative correlated data pairs of travel times and flow-related transport resistances (Odén et al. 2014). These data sets for the flow of water in the geosphere are sampled in probabilistically assessed calculation cases.

Other near-field, far-field and biosphere parameters (e.g. diffusivities, Péclet numbers,  $K_d$  and CR-values), are sampled from predetermined distributions in probabilistically assessed calculation cases; see the **Input data report** and the **Biosphere synthesis report** for details.

Best estimate values which are provided for all input parameters are applied in deterministic calculations.

Apart from the pairing of parameters describing hydrogeological conditions, parameter correlations are not accounted for in the probabilistic assessments. This approach rather overestimates uncertainty ranges and it is not assumed that it will tweak the assessment towards compliance. Data correlation is further addressed in the **Data report**.

The radionuclide transport in the near-field and in the far-field is basically controlled by the processes of diffusion and advection in the liquid phase and sorption between the liquid and solid phases. In the biosphere, additional processes are relevant, such as sedimentation, resuspension and plant uptake. Processes are modelled by algebraic or differential equations. With a compartment model approach the numerical model takes (after evaluation of algebraic equations) the form of a system of ordinary differential equations.

The Ecolego tool has been used to implement the entire modelling chain consisting of near-field, far-field and biosphere as indicated in Figure 8-2; see the **Model summary report** for more information about Ecolego.

The models are built using the compartment model approach, where the modelled system is represented by a number of compartments and transfers between them. Compartments represent local entities comprised of matter (in different aggregate states, i.e. aqueous solution, solid matter, gas) and inventories of radionuclides contained in these. The rate of change of the amount of radionuclides (Bq/yr) in a compartment is described by Equation 8-1:

$$\dot{A}_i^n = \sum_{j \in N_i} Tr_{ji}^n - \sum_{j \in N_i} Tr_{ij}^n + \sum_{p \in P_n} Br_p^n \lambda^n A_i^p - \lambda^n A_i^n + r_i^n \quad (\text{Equation 8-1})$$

where

$A_i^n$  : inventory of radionuclide  $n$  in compartment  $i$ , [Bq],

$\dot{A}_i^n$  : change rate (time derivative) of  $A_i^n$ , [Bq/yr],

$A_i^p$  : inventory of parent nuclide  $p$  in compartment  $i$ , [Bq],

$N_i$  : set of indices of compartments connected to compartment  $i$ , [-],

$P_n$  : set of indices of parents of radionuclide  $n$ , [-],

$Tr_{ji}^n$  : transfer for nuclide  $n$  from compartment  $i$  to  $j$ , [Bq/yr],

$\lambda^n$  : decay rate of nuclide  $n$  [1/yr],

$Br_p^n$  : branching ratio from parent nuclide  $p$  to radionuclide  $n$ , [-],

$r_i^n$  : sink/source term for radionuclide  $n$  in compartment  $i$ , [Bq/yr].

Transfers between compartments can often be described as a product of a transfer coefficient ( $TC$ ) with the radionuclide inventory of the compartment releasing the nuclides. This applies if the transport processes are linear, and this is the case for most processes covered here, i.e.:

$$Tr_{ij}^n = TC_{ij}^n A_i^n$$

The main modelling approach in the analysis is to perform probabilistic simulations (with respect to the input parameters) for the radionuclide transport and dose calculations. However, for some calculation cases this modelling approach is not feasible. For these cases, a deterministic approach is used.

## 8.2.2 Safety relevant radionuclides

Not all radionuclides in the waste are present at such a level that they are relevant when evaluating the radiological impact of the repository on humans or non-human biota. This section describes the selection of radionuclides that are considered in the calculations for the long-term safety assessment.

In Section 2.3.1 four categories of radionuclides with respect to their half-lives were introduced:

- Short-lived<sup>8</sup> radionuclides with a half-life less than 10 years.
- Short-lived radionuclides with a half-life longer than 10 years but less than 31 years. These radionuclides will decay to insignificant levels within a relatively short period of time. 10 half-lives of these radionuclides matches the time that, internationally, institutional controls may contribute to safety.
- Long-lived radionuclides with a half-life short enough to decay substantially during time periods of relevance for the design of the repository and/or the safety assessment. Time periods of relevance are for instance the time period when the shoreline passes the repository, the time period until a well for drinking water may be drilled into or downstream of the repository, the time period until the concrete barriers lose their function, and the time period until permafrost reaches repository depth.
- Long-lived radionuclides with a half-life so long that they will not decay substantially during the overall time period of this assessment.

<sup>8</sup> Short-lived waste is defined according to the IAEA Safety Glossary, 2007 Edition (IAEA 2007) as “radioactive waste that does not contain significant levels of radionuclides with half-lives greater than 30 years”. SKB uses the same definition but with 31 years to include cesium-137, which is used as a key radionuclide to estimate the content of other radionuclides. Waste that is not short-lived is consequently considered long-lived.

Two criteria have been postulated for a radionuclide to be included in the analysis 1) the half-life is longer than 10 years, and 2) the (ingestion) radiotoxicity of the inventory of the radionuclide at the time of repository closure exceeds 0.01 Sv. Calculations are done for radionuclides that fulfils these criteria.

Because of the first criterion, at least 10 half-lives will pass for radionuclides rejected by the first criterion within a period of 100 years after disposal, reducing their initial inventory by more than three orders of magnitude. The inventory of the rejected radionuclides have decreased to insignificant amounts before the potential discharge areas emerge from the sea more than 1,000 years after repository closure. The reasoning behind the second criterion is that 0.01 Sv is deemed to be a reasonably small screening limit, since it is less than three orders of magnitude higher than the annual effective dose corresponding to the risk criteria (not taking credit for a probability smaller than 1 of the underpinning scenario). The assumption is that engineered and natural barriers as well as radioactive decay would reduce any radiological impact of radionuclides rejected by the second criterion to a negligible level before radionuclide release and exposure might occur. The chosen limit seems also to be reasonably small with respect to scenarios dealing with future human actions compromising the repository system.

Progeny of radionuclides in the inventory have also to be considered for their safety relevance, independent of the assigned initial inventory. The inventory of such “secondary radionuclides” occurring in the repository system results from radioactive in-growth only or from the initial inventory and in-growth. The selection criteria for progeny are that their radiotoxicity surpasses the screening limit of 0.01 Sv during the assessment time frame and that they have half-life longer than 100 days. Progeny with a half-life of less than 100 days are not explicitly modelled in the transport calculations, but are considered implicitly in the dose calculation assuming that they are in secular equilibrium with their parent nuclides; see Grolander (2013) for details.

Explicitly modelled radionuclides are listed in Table 8-1 for radionuclides that are not part of the (4n+m) decay chains and in Table 8-1 for radionuclides that are part of the (4n+m) decay chains.

Nb-93m is decay product of Zr-93 and Mo-93 and is the only explicitly modelled decay product of radionuclides listed in Table 8-1. Implicitly modelled progeny are Y-90 (from decay of Sr-90), Ag-108 (from decay of Ag-108m), Sb-126m and Sb-126 (from decay of Sn-126) and Ba-137 (from decay of Cs-137).

For the following radionuclides, also listed in Table 8-2, various progeny are implicitly considered. These progeny are either listed below (for up to two nuclides) or their number is specified in brackets: Pb-210 (Bi-210), Ra-226 (6 radionuclides), Ac-227 (9 radionuclides), Th-228 (6 radionuclides), Th-229 (9 radionuclides), U-235 (Th-231), Np-237 (Pa-233), U-238 (Th-234, Pa-234m), Pu-241 (U-237), Am-242m (Am-242, Np-238) and Am-243 (Np-239). See Grolander (2013) for details.

Table 8-2 reports the decay paths of explicitly modelled radionuclides of the four decay chains applied in the radionuclide modelling. Half-lives and branching ratios are documented in the **Radionuclide transport report**.

**Table 8-1. Radionuclides which transport is explicitly modelled, but not part of the (4n+m)-decay chains.**

H-3	Se-79	Pd-107	Cs-135
C-14	Sr-90	Ag-108m	Cs-137
Cl-36	Zr-93	Cd-113m	Sn-126
Ca-41	Nb-93m	Sn-126	Sm-151
Co-60	Nb-94	I-129	Eu-152
Ni-59	Mo-93	Ba-133	Ho-166m
Ni-63	Tc-99		





Access tunnels and plugs are not explicitly represented in the radionuclide transport model. The influence of these plugs is however taken into account by their impact on water flows, which serve as input data for the radionuclide transport model.

In the model, the interior of the waste domain was assumed to be homogeneous (Abarca et al. 2013). For waste packages in the vaults 1–2BTF, silo and 1–2BMA the water flowing into the waste domain was also assumed to flow through the waste packages, due to the moderate difference in hydraulic conductivity between grouting and waste packages.

In the case of 1–5BLA the waste component is part of the hydrological model with a homogeneously assigned conductivity. Hence, the water flow through waste and backfill is simulated and applicable for the parameterisation of the radionuclide transport model. In the case of the BRT vault, the waste consists of reactor pressure vessels through which water cannot flow.

### ***Model waste package types***

Since it is not feasible to represent each waste package or even each waste package type separately in the model for 1–2BMA, 1–2BTF and the silo, the waste packages are represented in a simplified way. As many of the waste package types have similar properties, the chosen approach is to group similar types and to represent each of the groups by a representative model waste package type.

For the 1–5BLA the waste packages were not represented individually. The representation of waste packages for the 1–2BMA, 1–2BTF and silo models is described below.

#### **Waste solidified with cement or embedded in concrete in concrete moulds**

This model waste package type is represented with three compartments, two for the waste form and one for the concrete mould. This model waste package type comprises concrete moulds with cement-solidified ion-exchange resins, evaporate concentrate and sludge and concrete-embedded trash and scrap metal from operational waste in BMA and silo, and concrete-embedded trash and scrap metal from decommissioning waste in BMA (**Radionuclide transport report**).

#### **Waste solidified with cement or embedded in concrete in steel moulds**

This model waste package type is represented with two compartments for the waste form; the steel packaging is not accounted for in the modelling. This model waste package type comprises steel moulds with cement-solidified ion-exchange resins and sludge and concrete-embedded trash and scrap metal from operational and decommissioning waste in BMA and silo, as well as concrete-embedded trash and scrap metal, concrete and sand in tetramoulds from decommissioning waste in BMA (**Radionuclide transport report**).

#### **Waste solidified with cement or embedded in concrete in steel drums**

This model waste package type is represented with two compartments for the waste form; the steel packaging is not accounted for in the modelling. This model waste package type comprises steel drums with cement-solidified ion-exchange resins (silo), concrete-embedded ashes (BTF), trash and scrap metal (BMA) from operational waste, and concrete-embedded ashes (BMA) from decommissioning waste (**Radionuclide transport report**).

#### **Waste solidified with bitumen in steel moulds**

This model waste package type is represented with only one compartment for the waste form; the steel packaging is not accounted for in the modelling. This model waste package type comprises bitumen-solidified ion-exchange resins in steel moulds (BMA and silo) from operational and decommissioning waste (**Radionuclide transport report**).

### Waste solidified with bitumen in steel drums

This model waste package type is represented with only one compartment for the waste form; the steel packaging is not accounted for in the modelling. This model waste package type comprises bitumen solidified ion-exchange resins in steel drums from operational waste in BMA and silo (**Radionuclide transport report**).

### Concrete tanks with dewatered ion-exchange resins

This model waste package type is represented with two compartments, one for the waste form and one for the concrete tank walls. This model waste package type comprises only the de-watered ion-exchange resins in concrete tanks from operational waste in BTF (**Radionuclide transport report**).

### 1BMA

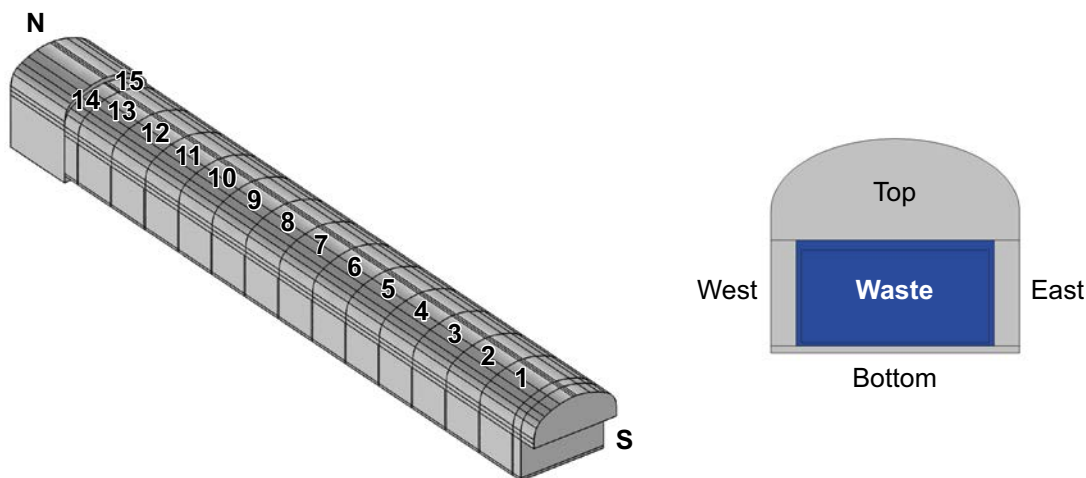
The 1BMA is described in detail in Section 4.3.1. Figure 8-4 shows the division of the vault into sections and control volumes. The control volume for the waste is surrounded by control volumes representing the surrounding backfill and the material beneath the floor of the concrete structure. Sections 14 and 15 cover only one half of the cross section of the vault and consist of three control volumes only with their waste domains being attached to each other.

Figure 8-5 shows a conceptual model of the different components (waste, backfill and barriers) and processes considered in the radionuclide transport model.

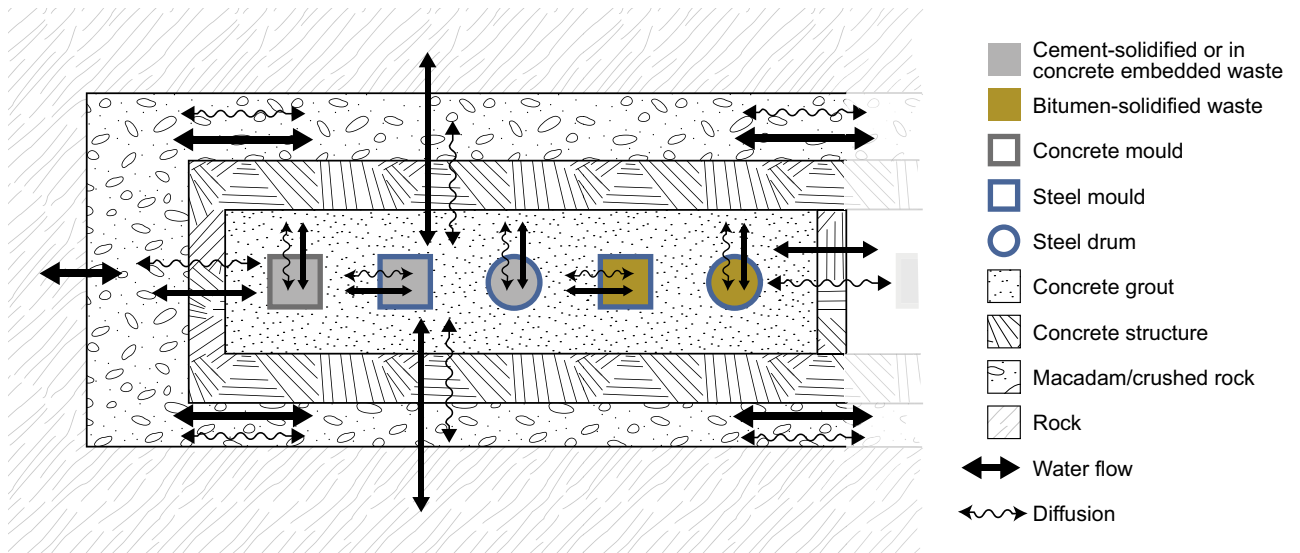
The radionuclide transport model of the 1BMA vault represents the waste domain in every section by a dedicated compartmental structure (comprising the concrete structures). The control volumes representing backfill are modelled by a single compartment each. This holds also for the backfill in the two ends of the vault. Figure 8-6 shows a relevant part of the compartmental structure. The outer concrete walls of the waste domain in each section (thick black line in the figure) are represented with five compartments each. The red boxes represent areas with waste containing up to five different model waste package types (i.e. cement-conditioned waste in concrete mould, cement-conditioned waste in a steel mould, cement-conditioned waste in a steel drum, bitumen-conditioned waste in a steel mould, and bitumen-conditioned waste in a steel drum).

### Silo

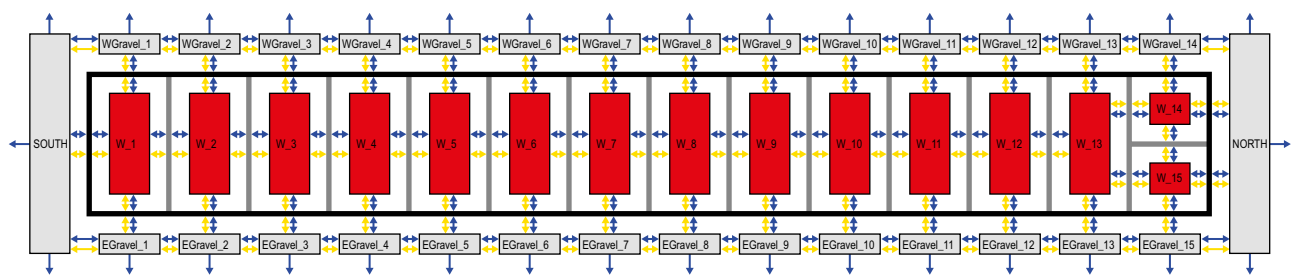
The silo is described in detail in Section 4.3.4. The vertical shafts of the silo are grouped in nine control volumes as indicated in Figure 8-7 (right hand side). Vertically, the silo is divided into 8 layers: 5 layers representing the waste domain, one layer each for sand/bentonite at the top and bottom, and one layer of backfill (macadam/crushed rock) at the top of the silo.



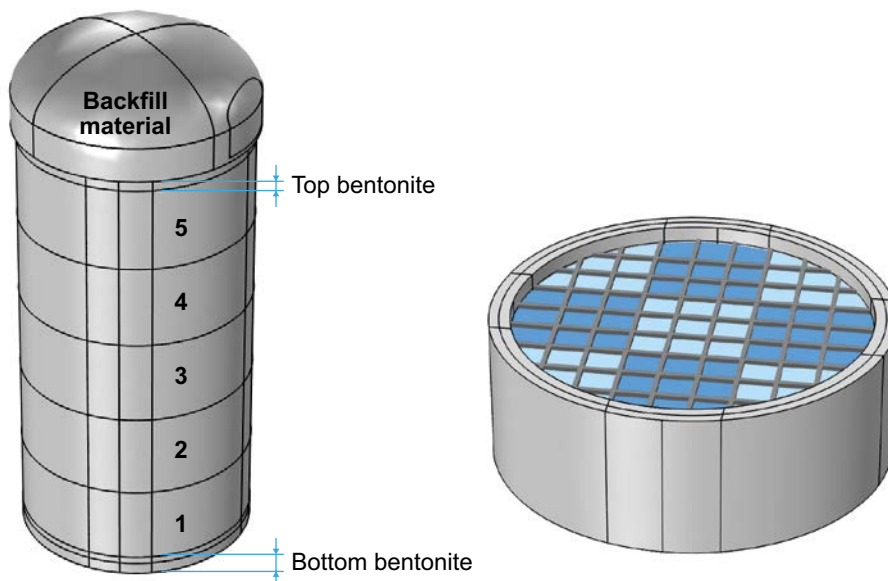
**Figure 8-4.** Sections (left) and control volumes (right) for the hydrological model of the 1BMA vault (Abarca et al. 2013).



**Figure 8-5.** Conceptual model for radionuclide transport in one section of the IBMA vault. Innermost are five different model waste package types shown (from the left): waste package with cement-solidified or concrete embedded waste in concrete mould, cement-solidified or concrete embedded waste in a steel mould, cement-solidified or concrete embedded waste in a steel drum, bitumen-solidified waste in a steel mould, and bitumen-solidified waste in steel drum (figure modified from Lindgren et al. 2001).

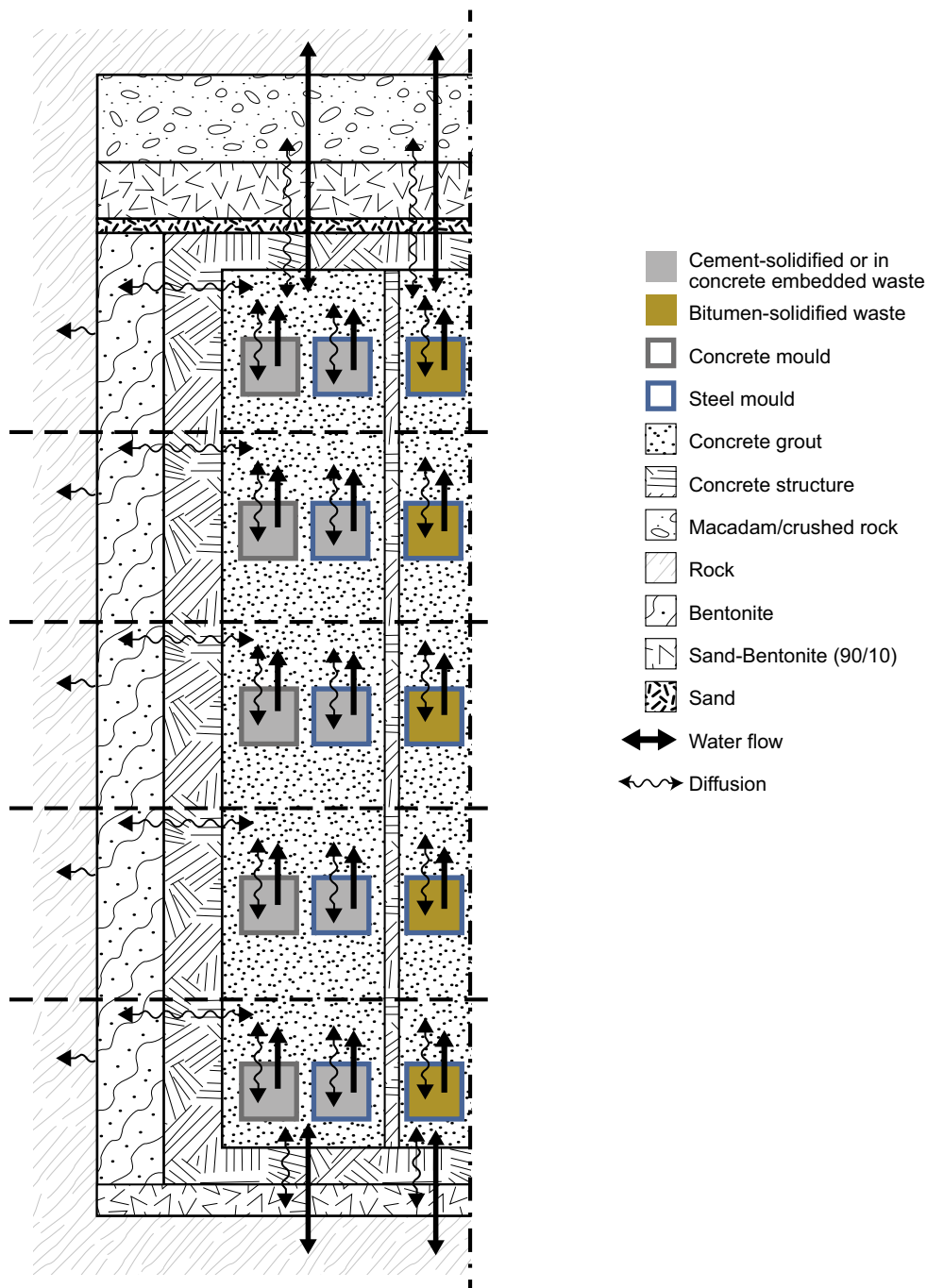


**Figure 8-6.** Schematic view of the IBMA radionuclide transport model. The figure shows a horizontal cross section. Blue arrows represent water flows, yellow arrows represent diffusive transport. Every red box in the figure represents several waste packages.



**Figure 8-7.** Control volumes of the silo in the hydrological model (Abarca et al. 2013).

Figure 8-8 shows a concept of the different components (waste, backfill and barriers) and processes considered in the radionuclide transport model.

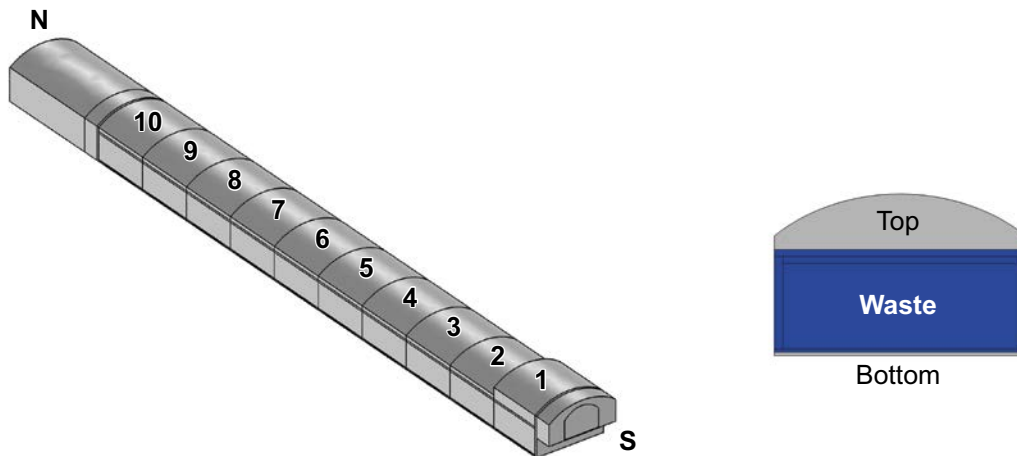


**Figure 8-8.** Conceptual model of radionuclide transport in the silo. The figure shows three different model waste package types; from the left: waste packages with cement-solidified or in concrete embedded waste in concrete moulds, cement-solidified or in concrete embedded waste in steel packaging and bitumen-solidified waste in steel packaging (figure modified from Lindgren et al. 2001).

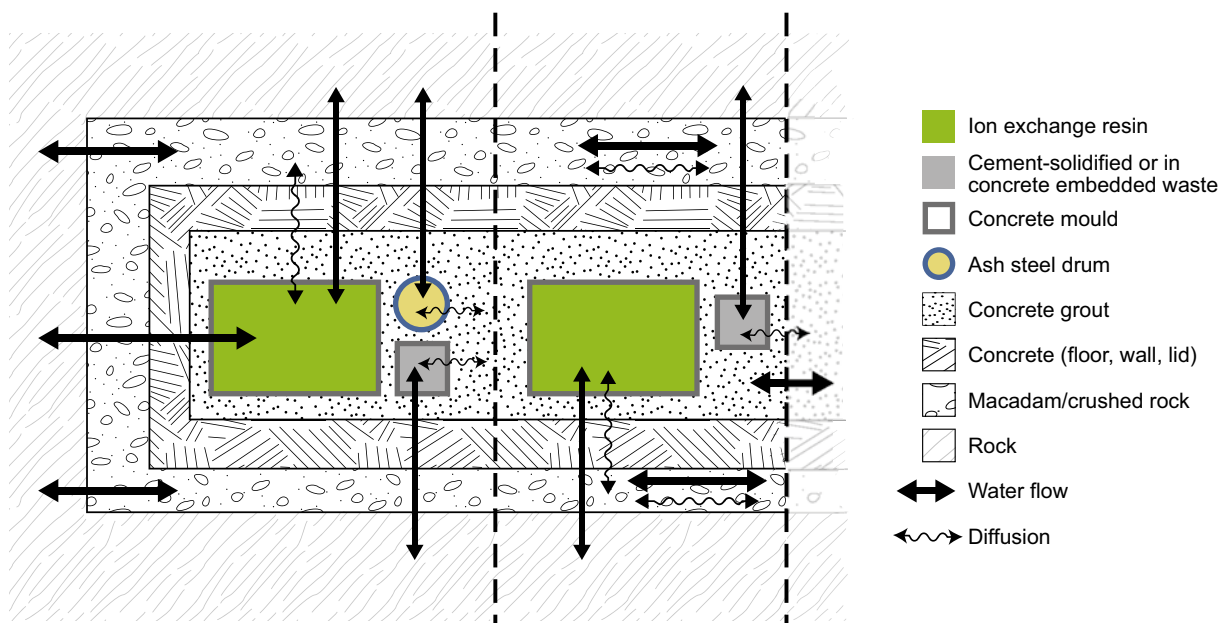
### 1BTF and 2BTF

The 1–2BTF vaults are described in detail in Section 4.3.3. For 1BTF and 2BTF, the waste domain is divided into 10 sections, each consisting of two control volumes for (bottom) waste and (top) gravel domains as shown in Figure 8-9.

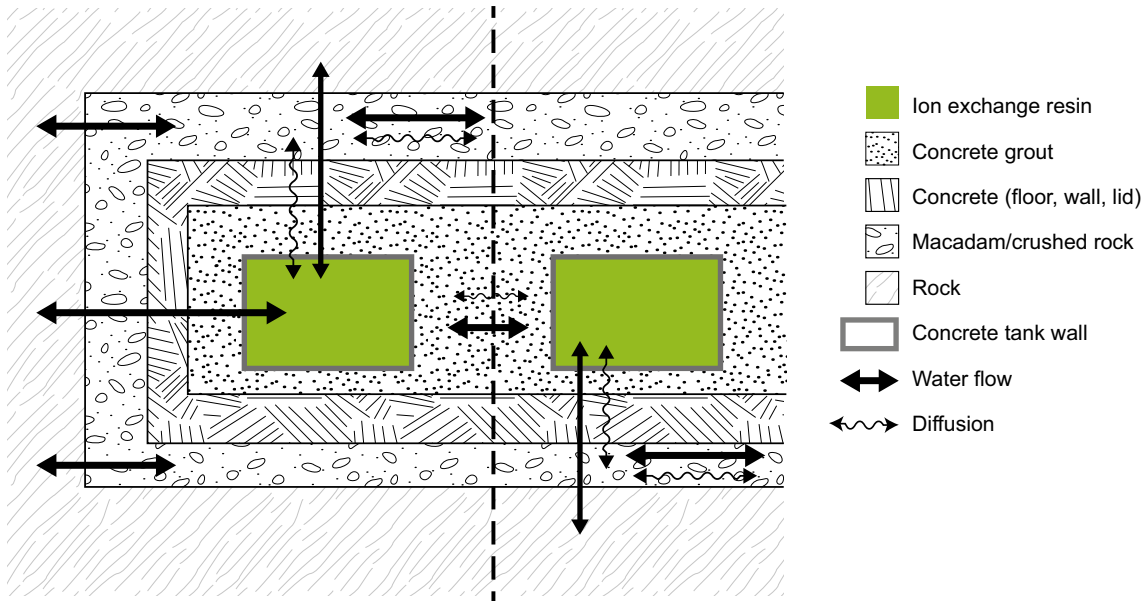
The discretisation of the concrete constructions is further refined in the radionuclide transport model. The conceptual models for radionuclide transport in 1BTF and 2BTF are presented in Figure 8-10 and Figure 8-11, respectively.



**Figure 8-9.** Sections (left) and control volumes (right) for the hydrological model of the BTF vaults (Abarca et al. 2013).



**Figure 8-10.** Conceptual model of radionuclide transport in the 1BTF vault. The figure shows the three different model waste package types: concrete tanks, ash drums, and cement-solidified or embedded in concrete waste in a concrete mould. The reactor tank lid disposed of in this vault is not shown in the figure (figure modified from Lindgren et al. 2001).

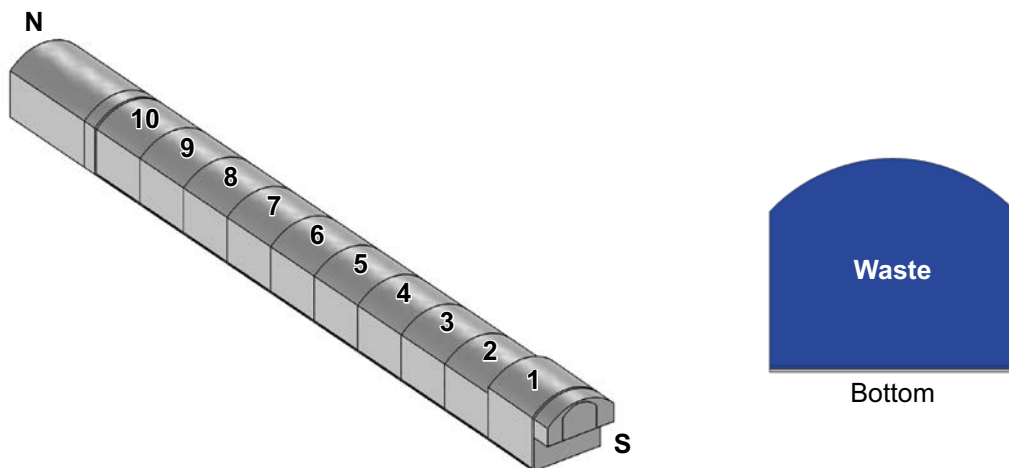


**Figure 8-11.** Conceptual model of radionuclide transport in the 2BTF vault. This model contains mainly concrete tanks as waste package types (figure modified from Lindgren et al. 2001); details are to be found in the *Radionuclide transport report* and the *Initial state report*.

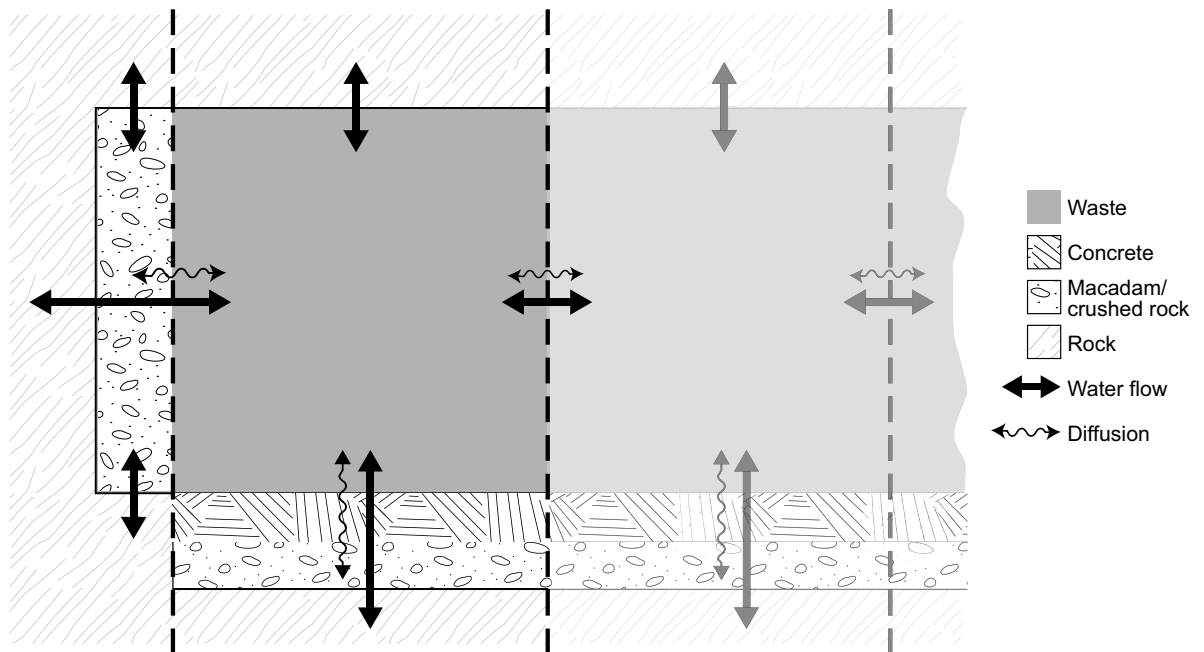
### 1BLA

The 1BLA vault is described in detail in Section 4.3.5. The waste domain is divided into 10 sections. Each section of the 1BLA is represented by a single control volume as shown in Figure 8-12.

The conceptual model of radionuclide transport in the vault is presented in Figure 8-13. Sorption is not taken into account.



**Figure 8-12.** Sections (left) and control volumes (right) for the hydrological model of the 1BLA vault (Abarca et al. 2013).



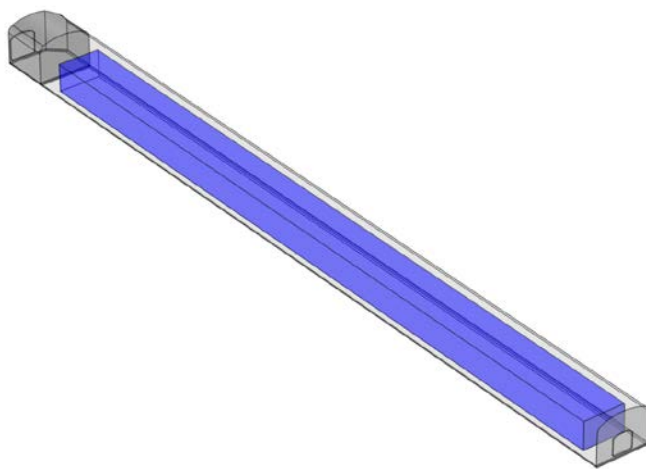
**Figure 8-13.** Conceptual model for radionuclide transport in the 1BLA vault. A simple mixed tank model represents the waste domain. The potential sorption capacity of the concrete slab below the waste is not taken into account (figure modified from Lindgren et al. 2001).

### 2-5BLA

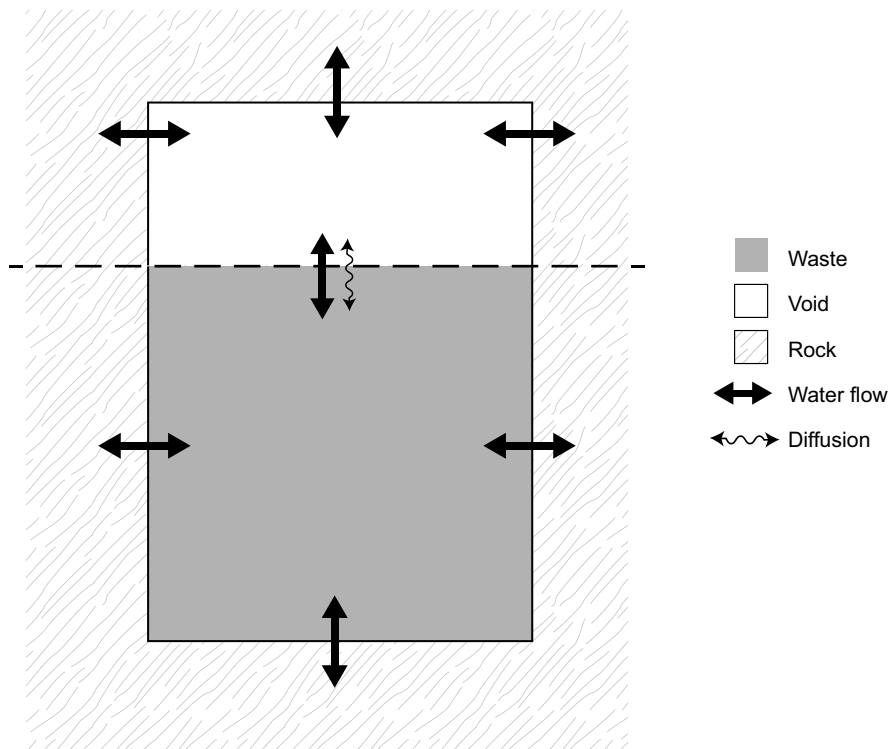
The 2-5BLA vaults are described in detail in Section 4.3.6. The vaults are similar to 1BLA, but a simpler compartmental structure than for 1BLA was developed for their representation. The four models are identical apart from the parameterisation of water flow related input data. Only two compartments are used in the model, one representing the waste, the other representing the void space (see Figure 8-14 and Figure 8-15). Sorption is not taken into account in these near-field models.

### BRT

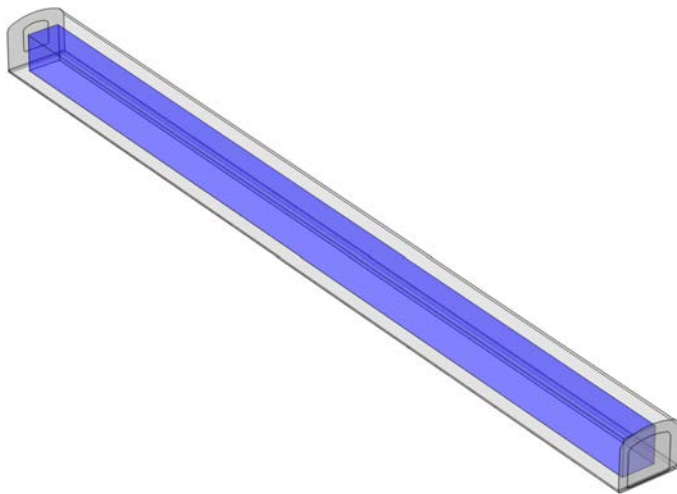
The BRT vault for whole reactor pressure vessels is described in detail in Section 4.3.7. The two control volumes of the hydrological model, the first representing the waste domain and the second the surrounding concrete structure with backfill, are shown in Figure 8-16.



**Figure 8-14.** Control volumes of a vault of 2-5BLA type. The control volume representing the waste domain is coloured in blue while the surrounding void space is shaded in light grey. The loading area (dark grey) is not represented by compartments in the radionuclide transport model; its presence is accounted for by its impact on water flow (modified from Abarca et al. 2013).



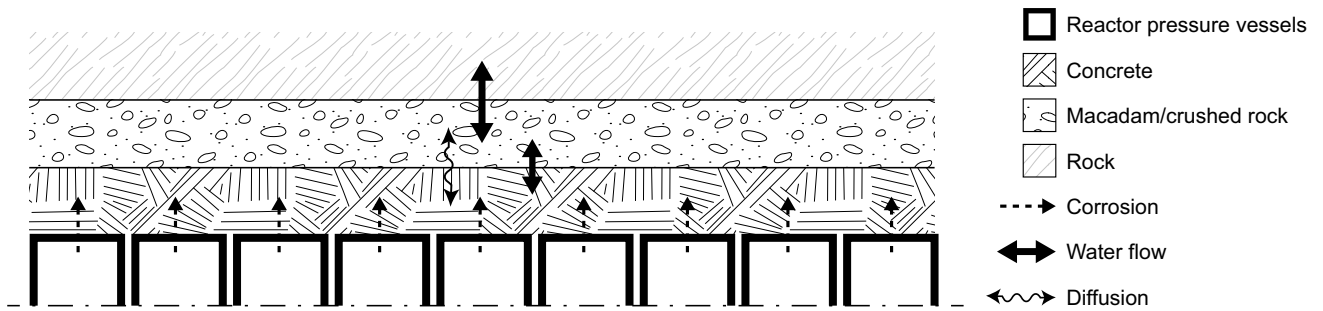
**Figure 8-15.** Conceptual model of radionuclide transport in the 2-5BLA vaults.



**Figure 8-16.** Control volumes of the BRT vault with the control volume for the waste domain coloured in blue and the surrounding backfill and concrete shaded in light grey. In the radionuclide transport model the waste domain was further divided into nine compartments each representing one of the reactor pressure vessels (see Figure 8-17).

The conceptual model of the radionuclide transport in the BRT vault is shown in Figure 8-17. The compartmental representation of the waste domain is split into nine compartments, each representing one of the reactor pressure vessels. The other control volume is represented by two compartments modelling concrete and backfill as conceptualised in Figure 8-17.





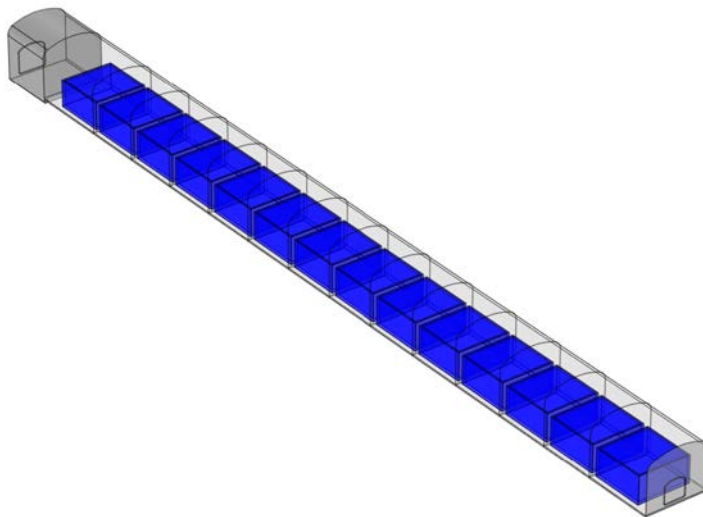
**Figure 8-17.** Conceptual model of radionuclide transport in the BRT vault. The nine reactor pressure vessels in the waste domain (see Figure 8-16) are represented by one compartment each; macadam/crushed rock and the concrete structure are also each represented by a single compartment.

## 2BMA

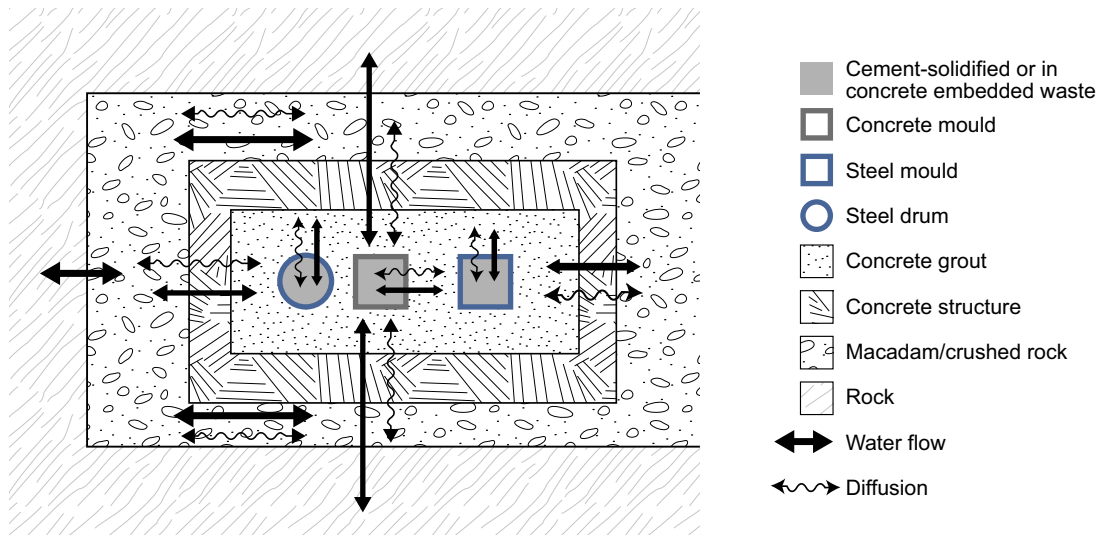
The 2BMA vault is described in detail in Section 4.3.2. In the hydrological model the vault splits into 14 sections each represented by two control volumes for the waste domain and the surrounding backfill, Figure 8-18. The 14 waste control volumes, each representing a caisson, are not contiguous.

Figure 8-19 shows the conceptual model how the different components (waste, backfill and barriers) and processes interact in this near-field model.

In the radionuclide transport model, the 14 caissons are represented by dedicated compartmental structures. The wall and macadam backfill surrounding a caisson is represented by another compartmental structure. Also, the backfill in one end of the vault is represented by a single compartment. The waste inside each caisson is modelled by three different model waste packages, each representing a larger number of real waste packages (see Figure 8-19).



**Figure 8-18.** Control volumes of the 2BMA vault in the hydrological model. The waste domain splits into 14 separate and not contiguous control volumes (blue). Each waste volume is surrounded by a control volume representing macadam backfill (shaded in light grey) (Abarca et al. 2013).



**Figure 8-19.** Conceptual model of radionuclide transport in the 2BMA vault. Model waste package types used (from the left): cement-conditioned waste in steel drum, cement-conditioned waste in concrete mould, and cement-conditioned waste in steel mould.

#### 8.2.4 Far-field

Radionuclide transport in the far-field was modelled in earlier safety assessments using the semi-analytic code FARF31 (Norman and Kjellbert 1990, SKB 2006b, 2010f, Lindgren et al. 2001). In the previous safety analysis for SFR, SAR-08, the same conceptual model was used, but the mathematical model was already implemented as a compartment model (Thomson et al. 2008). In this assessment, a model similar to that used in SAR-08 is applied with the discretisation being modified and the number of compartments increased; see Figure 8-20 and the **Radionuclide transport report** for details.

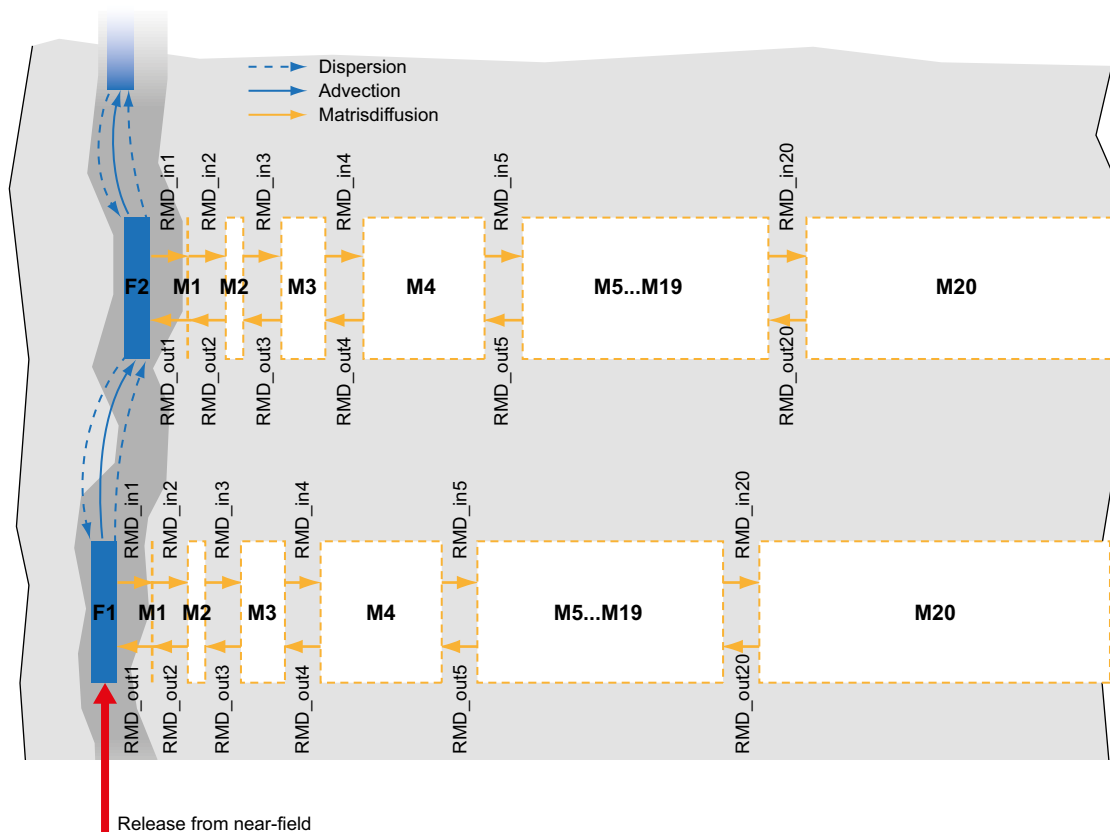
The model is based on equations for one-dimensional transport along path lines (conceptualised as stream tubes) with a dual porosity description and advection–dispersion in the mobile phase (flowing water) and diffusion into immobile water in the rock matrix, where sorption is taken into account. The hydrological modelling, from which travel times and the flow-related transport resistance is obtained for each waste vault (Odén et al. 2014). These data are used to parameterise the radionuclide transport model.

#### 8.2.5 Biosphere

The surface systems are represented by the radionuclide model for the biosphere. This consists of sub-models for radionuclide transport in the (natural) ecosystems and models for the calculation of dose to humans and non-human biota. The latter are conceptually described in Section 7.4.5.

The radionuclide transport model for the biosphere is based on a corresponding model used in the SR-Site assessment (SKB 2010e, Avila et al. 2010). The SR-Site model includes: (i) the continuous development of the biosphere objects as function of shoreline displacement and succession of ecosystems, (ii) a time-dependent release of radionuclides with ground water from the geosphere, and their distribution in a heterogeneous landscape, (iii) transport, accumulation and decay of radionuclides with different biogeochemical properties, (iv) transport of radionuclides between different parts of the landscape with water and as a result of terrestrialisation, and (v) exposure and dose calculations for future inhabitants in the landscape (SKB 2010e, Avila et al. 2010, 2013).

The SR-site model has been improved in several ways for the SR-PSU assessment. This has been done to better capture the fate of radiocarbon for more complete estimates of activity concentrations in air, soil and water. Moreover, most exposed groups for the assessment of human exposure have been defined to explicitly reflect the behaviour of self-sustained historical and present communities. In addition, the calculations of dose rates to non-human biota, previously carried out in the ERICA Tool, has been integrated into the Ecolego implementation of the model (see Saetre et al. 2013 for details). Also, the description of the landscape development in the area above the repository has been refined resulting in more realistic input data for the calculation cases.



**Figure 8-20.** Conceptual description of the geosphere model as a vertical structure of fractures (F) with confining rock matrix (M). A total of 420 compartments are used in the model. The blue boxes represent the compartments in the model used to represent flow in water-bearing fractures, and the white boxes represent compartments used to represent diffusion in the rock matrix. Solid blue arrows represent advective transport, dashed blue arrows represent dispersion, and yellow arrows represent diffusion (figure modified from Thomson et al. 2008).

### Biosphere objects

Discharge areas for groundwater from the repository is based on hydrogeological modelling (Odén et al. 2014, Section 7.4.2). These discharge areas are the parts of the landscape where radionuclides from a potential release from the repository could reach the biosphere, and are referred to as biosphere objects in the present modelling of radionuclide transport and dose. Radionuclides entering a biosphere object with discharging groundwater can be retained there, but may also be transported with surface and subsurface water to adjacent biosphere objects where they may accumulate and/or be transported further. The biosphere objects are shown in Appendix H, and identification and detailed delineation of biosphere objects and associated catchment areas used in SR-PSU are described in the **Biosphere synthesis report**.

Conceptual models for radionuclide transport to, within and between biosphere objects under submerged (sea-covered) and terrestrial (land) conditions are sketched in Figure 8-21 and Figure 8-22, respectively. The entire discharge of groundwater from the repository that reaches the biosphere under temperate conditions is expected to reach one biosphere object, i.e. object 157\_2. From 157\_2 radionuclides are transported to other biosphere objects and, in total, seven biosphere objects are considered for this period. In addition, periglacial climate conditions where permafrost restricts groundwater flow and radionuclide transport to certain parts of the geosphere and biosphere are considered. During periglacial periods discharge is considered to reach two potential biosphere objects, of which one object is not reached by radionuclides during the temperate periods.

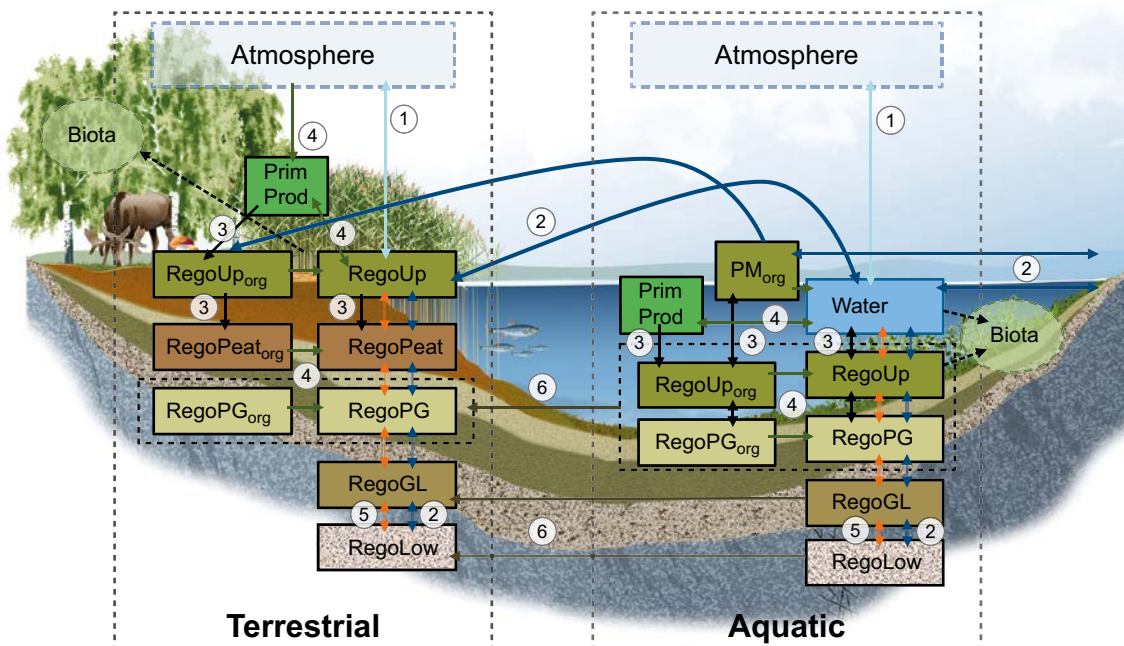


### Radionuclide transport model

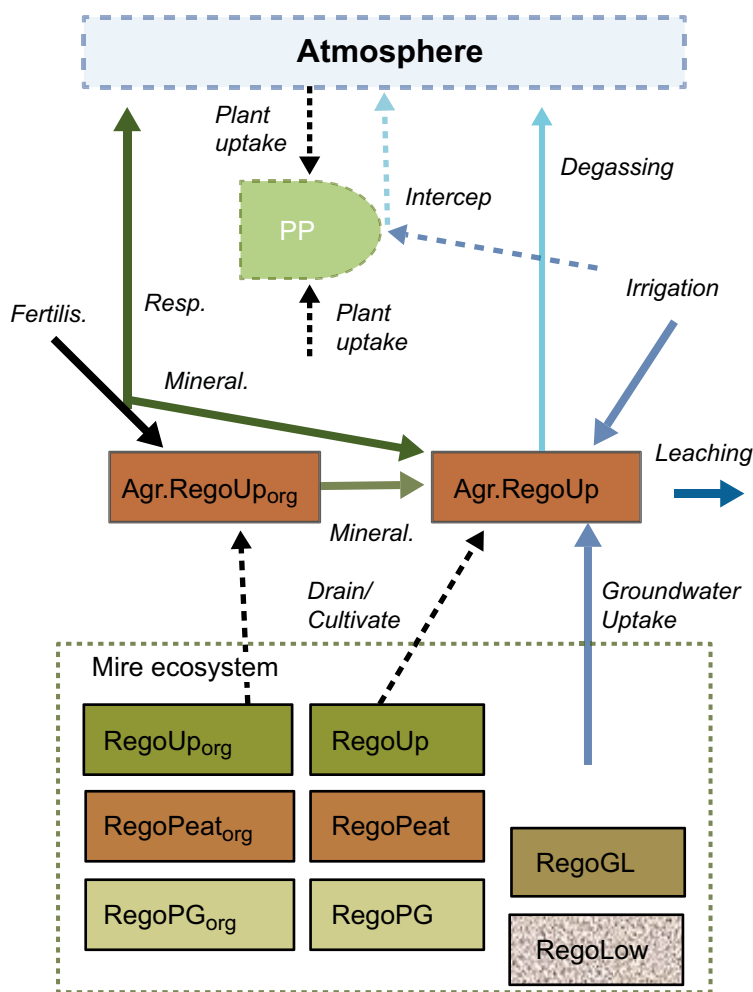
The radionuclide transport model consists of a number of interconnected biosphere objects. Each biosphere object undergoes a transformation due to land rise, from a marine ecosystem to a wetland ecosystem. Most biosphere objects also pass through an interconnected lake-mire stage.

To simulate the transport of radionuclides in and between the biosphere objects, a compartmental model is used (Saetre et al. 2013). This approach assumes that the distribution of radionuclides in the biosphere can be represented by a limited number of homogenous and interconnected compartments. This is a highly simplified representation of radionuclide transport in surface systems. However, the effects of radionuclides on humans and non-human biota should be assessed for releases over time scales of thousands of years and a spatial scale in the order of hectares. Thus, in this context, it is considered as reasonable to represent an ecosystem using temporally and spatially averaged conditions.

Two types of ecosystems are simulated: aquatic (sea, lakes and streams) and terrestrial (mire and agricultural ecosystems). The distribution of radionuclides in aquatic ecosystems is represented by six compartments associated with regolith layers, two compartments associated with the water, and one compartment associated with aquatic primary producers (Figure 8-23, Table 8-3). Correspondingly, the distribution of radionuclides in mire ecosystems is represented by eight compartments associated with regolith layers and one compartment associated with mire vegetation (Figure 8-23, Table 8-3). For agricultural ecosystems a simpler model is used, which only describes the distribution of radionuclides between an organic compartment and an inorganic compartment in the upper regolith of cultivated land (Figure 8-24, Table 8-3). The dynamic change in the radionuclide content of each compartment is related to the flow of water, solid matter or gas, and is also due to diffusion, photosynthesis, mineralisation and to radioactive decay and in-growth.



**Figure 8-23.** A graphical representation of the radionuclide transport model used to simulate transport and accumulation in a discharge area with two natural ecosystems, the terrestrial and aquatic system (each delimited by thin dotted black lines). Each box in the two ecosystems corresponds to a radionuclide inventory associated with a physical compartment. Arrows represent radionuclide flows between compartments and flows into and out of the system. Radionuclide flows are linked to flows of gas (1, light blue), water (2, dark blue) and solid matter (3, black), to transitions between inorganic and organic forms of radionuclides (4, green), to diffusion in soil pore water (5, orange), and to in-growth of wetland vegetation (6, grey). The atmosphere serves as a source and sink of radionuclides. The uptake of radionuclides into consumers (biota) conservatively does not withdraw inventory from the system of radionuclide transport in the natural ecosystems.



**Figure 8-24.** A conceptual representation of the radionuclide transport model used for agricultural ecosystems. Each box corresponds to a radionuclide inventory associated with a physical compartment. Solid arrows represent radionuclide fluxes between compartments and fluxes into and out of the system. Radionuclide fluxes are linked to diffusion of gas (light blue), to mass fluxes of water (dark blue) and solid matter (black), and to mineralisation (green). Four sources of radionuclides are represented: 1) irrigation, 2) fertilisation, 3) draining and cultivation of a lake-mire system and 4) groundwater uptake. The activity concentration in crop is calculated assuming that the plant is in equilibrium with radionuclides in soil and the canopy atmosphere (plant uptake), and that radionuclides in irrigation water are intercepted by the canopy. Note that all land use variants use a different set of source terms (see text and Saetre et al. 2013).

Radionuclides in the model are released to the deepest regolith layer (RegoLow) of biosphere object 157\_2. The other biosphere objects receive releases of radionuclides via surface and ground water from adjacent biosphere objects. All identified biosphere objects are currently situated below sea-level. The radionuclide transport model takes into account the natural and continuous succession of the ecosystems by the characteristics of the objects (for example water and soil depth) to be changed over time, and by connecting aquatic and terrestrial ecosystems (Figure 8-23). The agricultural systems are modelled separately from the natural ecosystems, but taking into account accumulated inventories of radionuclides and radionuclide flows (e.g. induced by fertilising and irrigation) from the natural ecosystems as initial conditions and source terms (Figure 8-24).

The transport modelling provides radionuclide concentrations in different media in the environment, that is, ground- and surface water, the various layers of the regolith, mire vegetation (for harvest) and the atmosphere. Humans, plants and animals are then assumed to come into contact with the radionuclides via these media.

The distribution of radionuclides in the landscape is simulated by linking the biosphere objects via surface water flow. Parameters that describe the characteristics of the biosphere objects (and their

changes over time) and connections in the landscape, have been derived from the site investigation programme and simulations of the Forsmark area (Chapters 4 and 6).

### **Biosphere calculation cases**

Seven alternative biosphere calculation cases (BCC) listed in Table 8-4 have been set up to address aspects of uncertainty with respect to scenario, system and model, also meeting the request to provide cases from the biosphere assessment that can be consistently applied with the main calculation cases. In this context, the model uncertainties relate to the simplifications and delimitations applied in the representation of the biosphere. The scenario uncertainty is mainly driven from uncertain future climate evolution (BCC2, BCC3 and BCC4), whereas BCC5 refers to unknown future human action. BCC6 shows that the assumption of concentrated release to biosphere object 157\_2 is a conservative simplification of the system, while BCC7 addresses alternative approaches to delineating biosphere objects in the landscape. Detailed descriptions of the BCC are provided in the **Biosphere synthesis report**. From the BCC mentioned in Table 8-4 only those addressing alternative scenarios, i.e. BCC1 to BCC5, are assigned to main calculation cases. The two cases BCC6 and BCC7 investigating system uncertainty were applied in assessing the radionuclide model for the biosphere assuming constant radionuclide releases from the geosphere.

**Table 8-3. Brief description of the compartments representing radionuclide inventories in the radionuclide transport model for the biosphere.**

Model compartment	Description
<b>Aquatic</b>	
Water	Radionuclides in open water of sea basins, lakes and streams, including radionuclides dissolved in water and adsorbed to particular matter.
PM <sub>org</sub> <sup>1</sup>	Radionuclides stored in organic particulate matter suspended in the water column.
Prim Prod	Radionuclides stored in aquatic primary producers, including radionuclides in pelagic, microbenthic and macrobenthic primary producers.
RegoUp	Radionuclides in the upper oxic and biological active layer of aquatic sediments, including radionuclides in pore water and adsorbed on sediment particles.
RegoUp <sub>org</sub>	Radionuclides incorporated into organic particulate matter in the upper aerobic and biological active layer of aquatic sediments.
RegoPG	Radionuclides in post-glacial aquatic sediments (clay gyttja) below the biological active layer, including radionuclides in pore water and adsorbed on sediment particles.
RegoPG <sub>org</sub>	Radionuclides incorporated into organic particulate matter in post-glacial aquatic sediments (clay gyttja) below the biological active layer.
RegoGL	Radionuclides in glacial clay (typically overlaid by post-glacial deposits), including radionuclides in pore water and adsorbed on sediment particles.
RegoLow	Radionuclides in till (typically overlaid by glacial clay), including radionuclides in pore water and adsorbed on sediment particles.
<b>Terrestrial (mire)</b>	
PrimProd	Radionuclides stored in mire vegetation biomass, including both above and below ground biomass of bryophytes, vascular plants, dwarf shrubs and trees.
RegoUp	Radionuclides in the upper oxic and biologically active layer of wetland peat (acrotelm peat), including radionuclides in pore water and adsorbed on peat.
RegoUp <sub>org</sub>	Radionuclides incorporated into organic matter in the upper aerobic and biological active layer of peat (acrotelm peat).
RegoPeat	Radionuclides in deep, permanently anoxic, wetland peat (catotelm peat), including radionuclides in pore water and adsorbed on peat.
RegoPeat <sub>org</sub>	Radionuclides incorporated into organic matter in the deep, permanently anoxic wetland peat (catotelm peat).
RegoPG	Radionuclides in post-glacial sediments (clay gyttja) overlaid by wetland peat, including radionuclides in pore water and adsorbed on sediment particles.
RegoPG <sub>org</sub>	Radionuclides incorporated into particulate organic matter in post-glacial sediments (clay gyttja) overlaid by wetland peat.
RegoGL	Radionuclides in glacial clay buried under wetland peat and typically overlaid by post-glacial deposits. Inventory includes radionuclides in pore water and adsorbed on sediment particles.
RegoLow	Radionuclides in till, buried under wetland peat and typically overlaid by glacial clay. Inventory includes radionuclides in pore water and adsorbed on sediment particles.

<sup>1</sup> Compartment is also referred to as Water<sub>org</sub> in the technical model description (Saetre et al. 2013).

**Table 8-4. Biosphere calculation cases (modified from Table 7-4 in the *Biosphere synthesis report*).**

Biosphere calculation case	Calculation case driver (category of uncertainty)	Biosphere objects with geosphere release
BCC1 Base case / global warming	Reference case	157_2
BCC2 Talik	Climate (scenario)	157_1, 157_2, 114
BCC3 Extended global warming	Climate (scenario)	157_2
BCC4 Submerged conditions	Climate (scenario)	157_2
BCC5* Well	Exposure pathway (scenario)	157_2
BCC6 Distributed release	Radionuclide release and distribution (system)	Distributed release across all biosphere objects
BCC7 Alternative object delineation	Radionuclide release and distribution (system)	157_2

\* Intrusion wells and wells downstream of the repository, or abandoned tunnel entrance to the repository.

### 8.3 Calculation cases in the main scenario

The main scenario is described in Section 7.4. Two variants of the main scenario are defined based on two of the climate cases included in the reference evolution: the *global warming climate case* and the *early periglacial climate case* (Section 7.4.1). Three calculation cases have primarily been identified to analyse the main scenario: the *global warming calculation case* (CCM\_GW) and the *timing of the releases calculation case* (CCM\_TR) for the assessment of the *global warming variant* of the main scenario, and the *early periglacial calculation case* (CCM\_EP) for the assessment of the *early periglacial variant* of the main scenario. In addition to these three, the *collective dose calculation case* CCM\_CD has been identified in order to provide an alternative safety indicator as requested by Swedish regulation. The assessment time frame for the main scenario spans generally from the closure of the repository to 100,000 years into the future. These four calculation cases are described in the sections below.

#### 8.3.1 Global warming calculation case (CCM\_GW)

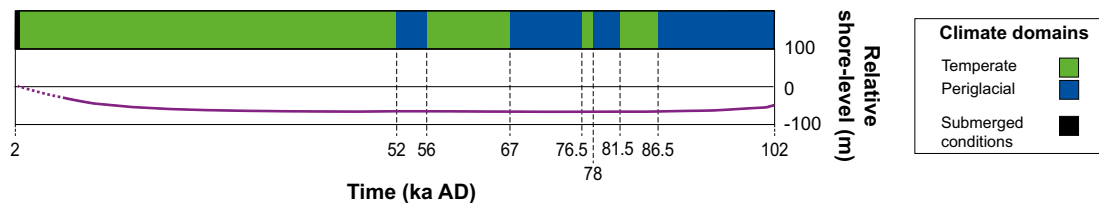
The *global warming climate calculation case* is based on the evolution of climate-related conditions in the *global warming climate case* (see Section 7.4.1). For the radionuclide transport modelling, the evolution of climate-related conditions in the *global warming climate calculation case* has however been simplified. The simplified evolution, shown in Figure 8-25, contains four periods of the periglacial climate domain, as compared with ten periods in the *global warming climate case* (see Figure 7-1). The total number of years with periglacial climate domain in this simplified evolution, 32,500 years, is similar to the corresponding number of about 31,000 years for the *global warming climate case*. During these periods of periglacial climate domain, continuous permafrost is assumed. Furthermore, it is assumed that during periods of continuous permafrost radionuclide releases from the repository to the geosphere and from the geosphere to the biosphere do not take place. The potential effects of shallow permafrost with taliks are evaluated in the *early periglacial calculation case* (see Section 8.3.2).

#### **Handling in the near-field model**

The *global warming calculation case* is based on the best estimate inventory of radionuclides and other elements at repository closure), see further Section 7.4.3.

After closure the repository will quickly become saturated. When the water comes into contact with the waste, radionuclides may dissolve into it. Dissolved radionuclides can then be transported, by diffusion or advection, out from the waste form, through the packaging and surrounding material and finally out from the repository.





**Figure 8-25.** Simplified evolution of climate-related conditions at Forsmark as a succession of climate domains and submerged periods in the global warming variant of the main scenario, which was used in the global warming calculation case. The corresponding evolution in the global warming variant of the main scenario is shown in Figure 7-1.

During periods of periglacial climate conditions (Figure 8-25), it is assumed that there is no water flow in the near-field. This is considered to be a cautious assumption with respect to the peak dose over the whole assessment time frame, as an outflow of radionuclides during periglacial climate conditions could only lead to exposure via a talik with low exposure levels (see the *early periglacial calculation case*). Over time, as the concrete degrades, the sorption capacity is also affected, hence different sorption partition coefficients,  $K_d$  values, are used for different parts of the repository and for different time periods with various degradation states (see Section 7.4.3, Figure 7-9). For the BLA vaults sorption is not taken into account.

The timing of repository saturation and the beginning of advective transport of radionuclides is uncertain. It might be considered conservative to assume an early beginning of radionuclide transport from the repository towards the surface. For the initial submerged state of potential exit points of the near surface environment this is not necessarily the case as early releases are diluted in the sea with low radiological impact. Two calculation cases have been defined to investigate the importance of this type of uncertainties (like the flow limiting effect of grouting of fractures and the properties of the engineered barriers). In the *global warming calculation case* (CCM\_GW) the radionuclide release does not begin until the conditions above SFR have changed to terrestrial, see Section 7.4.1. This is implemented by not activating any of the above-mentioned transport processes during the first 1,000 years. In the *timing of the releases calculation case* (CCM\_TR) the transport processes are modelled to begin immediately after closure, leading to an earlier release of radionuclides from the repository than in the *global warming calculation case* (see Section 8.3.3).

### **Handling in the far-field model**

The *global warming calculation case* is based on the base bedrock case (bedrock case 1), see further Section 7.4.2.

The results used in the probabilistic radionuclide transport calculations are travel times and flow-related transport resistances that are used in pairs from the same realisations/particle tracks. These pairs of parameter values are available for 2000 AD, 2500 AD, 3000 AD, 3500 AD, 5000 AD and 9000 AD. During permafrost no flow is assumed to take place, with the same argument as above for assuming no flow in the near-field.

### **The interface between far-field and biosphere**

Hydrogeological modelling of release locations in the landscape shows that on average, more than 80% (and in most cases more than 90%) of the total potential release from SFR 1 and SFR 3 would end up in biosphere object 157\_2 (**Biosphere synthesis report**). In this calculation case, the entire release is assumed to occur to biosphere object 157\_2, and radionuclides are then assumed to be transported to other objects through water exchange or through diffuse overland-water outflow and stream water.

### **Handling in the biosphere model**

The biosphere calculation case developed for the *global warming calculation case* is denoted BCC1, see Table 8-4. The evolution of the landscape in BCC1 follows that of the *global warming climate case* where the climate is assumed to be temperate for the first 50,000 years (see Chapter 5 in the **Biosphere synthesis report**). In the *global warming climate case* the annual average air temperature may increase by up to 3.7°C but will return to present conditions after about 25,000 years (**Climate report**). Ecosystem responses to the increased temperature (e.g. altered primary production or respiration) are uncertain (see Andersson (2010), Aquilonius (2010) and Löfgren (2010) for further discussion on potential ecosystem responses to warming). Therefore, the most reliable ecosystem data available for temperate conditions, i.e. site data under present conditions, are used for the entire period of this calculation case.

### **Landscape development**

Shoreline displacement occurs at Forsmark, and areas that are presently situated below the sea will gradually rise above sea level. Thus, biosphere object 157\_2 that is presently a marine basin will in time be transformed into a wetland area. If radionuclides were released during the submerged period, these radionuclides would reach all marine basins in direct, or indirect, contact with basin 157\_2, through lateral exchange of water. However, in the *global warming calculation case*, radionuclides are assumed to be released from the repository when the shoreline recedes from the area and biosphere object 157\_2 emerges above sea level. Radionuclides released to biosphere object 157\_2 during the terrestrial stage will only reach biosphere objects in the surface water chain downstream from object 157\_2 (namely 157\_1 and 116, further described in the **Biosphere synthesis report**). In this calculation case, the transport and fate of radionuclides are simultaneously simulated in multiple connected biosphere objects and each of these objects goes through a transition from a marine basin to a wetland ecosystem, often through a lake stage.

Note that the continuous transport and fate of radionuclides is simulated in a landscape that is undisturbed by human inhabitants. However, once biosphere objects have emerged sufficiently above sea level to prevent salt water intrusion, the consequences of draining and cultivating the lake-mire complex are also evaluated at each point in time by parallel simulations (conditioned on the state of the natural ecosystems), i.e. both natural and agricultural systems are evaluated at each time step.

### **Hydrological water fluxes**

Hydrological water fluxes are modelled for future biosphere objects at three points in time: 3000 AD (submerged period for all objects), 5000 AD (land period, when objects are either lake-mire complexes or mires) and 11,000 AD (land period, all objects are mires). For each point in time, groundwater fluxes were simulated in a landscape based on a separate, stationary three-dimensional regolith map, with streams connecting water bodies on land (this approach used the landscape development model, Brydsten and Strömgren 2013). Present day temperature and site data (with respect to precipitation, evaporation, and runoff) were used in the hydrological simulations for this calculation case. Hydrological modelling and parameter values are further described in Grolander (2013) and Werner et al. (2014).

### **Ecosystems**

Ecosystem parameters are based on site data from lakes, wetlands and marine basins in the area, and applied to future ecosystems assuming present-day conditions concerning nutrients and temperature (parameters are further described in Grolander 2013).

### **Exposed populations**

The annual effective dose to a representative human is calculated for four exposed populations, representing four variants of land use: *Hunters and gatherers* (H&G), *infield-outland farmers* (IO), *drained-mire farmers* (DM), and a *garden plot household* (GP). The different exposed populations are described in Section 7.4.5 and in the **Biosphere synthesis report**. Dose rates to non-human biota are, in the *global warming calculation case*, calculated for 11 marine, 13 limnic and 14 terrestrial organism types, two organism types living partly in marine and terrestrial ecosystems (combined habitats), and one organism type living partly in both limnic and terrestrial ecosystems (see Section 7.4.5).

### 8.3.2 Early periglacial calculation case (CCM\_EP)

The *early periglacial calculation case* is based on the evolution of climate-related conditions in the *early periglacial climate case* (see Section 7.4.1). The evolution of climate-related conditions is identical in the *early periglacial climate case* and the *global warming climate case* during the complete assessment time frame except for the period of minimum insolation around 17,500 AD to 20,500 AD where the *early periglacial climate case* has a period of periglacial conditions with permafrost and the *global warming climate case* has temperate conditions (compare Figures 7-1 and 7-2). Since the climate-related conditions in both climate cases are identical beyond 20,500 AD, the *early periglacial calculation case* focuses on the time period from repository closure up to 20,500 AD. During the early periglacial period included in this calculation case, the entire modelled area is land, and the regolith layers are frozen. Therefore, discharge of deep groundwater, and hence also release of radionuclides, is restricted to taliks (unfrozen areas in the otherwise frozen landscape).

Prior to the start of the periglacial period (17,500 AD) the discharge is assumed to reach biosphere object 157\_2 as in BCC1. For the periglacial period, results from bedrock hydrogeology modelling suggest that groundwater from the repositories may be discharged to wetlands North East of the present repository, and to large lakes formed in Öregrundsgrepen (Odén et al. 2014). Simulations of surface hydrology under periglacial conditions suggest that a discharge talik may be formed under a small wetland area (biosphere object 157\_1 just north of the primary release area during periods of temperate conditions). Moreover, the deep lake 114, located in Öregrundsgrepen, will still be open, and is thus likely to be connected with a discharge talik (Bosson et al. 2013, Werner et al. 2014). In this calculation case, the entire release between 17,500 and 20,500 AD is directed to biosphere object 157\_1 or to 114.

In the case of talik conditions in the biosphere, radionuclide transport in the far-field is based on hydrogeological modelling for temperate conditions. This is unlikely to be realistic as permafrost is changing hydrogeological features in parts of the bedrock and is particularly altering boundary conditions. The approach might still be more realistic in the case of a mire under talik conditions with only shallow permafrost than for a lake. The consequences of this assumption are discussed in the **Radionuclide transport report**.

The *early periglacial calculation case* is combined with the biosphere calculation case BCC2 (see Table 8-4 and details in the **Biosphere synthesis report**). The same biosphere model as in BCC1 was used for BCC2 but parameter values and biosphere objects were altered for the periglacial period in BCC2 (biosphere objects 114 and 157\_1). The hydrological water fluxes used in this case were modelled for colder and drier climate conditions at both the wetland and the lake taliks (Grolander 2013, Werner et al. 2014). Ecosystem parameter values for primary production, and production of edible fish and crayfish are altered (compared with values applied in BCC1) to better reflect permafrost conditions; these are based on literature data from colder environments (Grolander 2013). Effects of shore line displacement and ecosystem succession are not considered for the periglacial period, since at 17,500 AD the effects of isostatic rebound are insignificant for the model area, and ecosystem succession due to infilling of lakes is very slow during periglacial conditions (Brydsten and Strömgren 2010). For non-human biota, exposure is estimated to freshwater and terrestrial organisms. The same organisms as in BCC1 were assessed, with the exception that no limnic amphibians or mammals, and no terrestrial trees, gastropods, amphibians or reptiles are assumed to occur (see Chapter 7 in **Biosphere synthesis report** and Jaeschke et al. 2013).

During periglacial climate conditions, cultivation is not possible on drained mires due to permafrost, and wells will not yield any water in the frozen ground, hence the only exposed population considered in this calculation case is *hunters and gatherers*.

### 8.3.3 Timing of the releases calculation case (CCM\_TR)

As discussed in Section 8.3.1, in order to not underestimate the radiological consequence during later periods, the *global warming calculation case* does not assume any releases for the initial 1000 years after closure. The *timing of the releases calculation case* (CCM\_TR), has been carried out with the purpose of studying the effect on the outcome of the safety assessment of assuming releases during the submerged period, and to provide input to the calculation of collective dose (Section 8.3.4).

In this calculation case, the release of radionuclides commence directly after closure. Apart from this, the models of the near-field, the far-field and the biosphere are handled as in the *global warming calculation case*. Together with the *global warming calculation case*, together these covers the two extremes of possible outcomes.

#### **8.3.4 Collective dose (CCM\_CD)**

In addition to radiological risk, the regulations requires collective dose to be calculated. The regulations (SSM 2008:37) specify that: “The collective dose, as a result of the expected outflow of radioactive substances over a period of 1000 years after closure of a repository for spent nuclear fuel or nuclear waste shall be estimated as the sum, over 10,000 years, of the annual collective dose”. The *collective dose calculation case* is based on the geosphere releases from the *timing of releases calculation case*. Two populations were selected for the calculations: the global population exposed to C-14 releases into the atmosphere, and the Baltic population affected by the release of radionuclides to the Baltic Sea via subsequent exposure due to ingestion of fish.

The whole Baltic Sea region is represented by a single compartment in the modelling, and the only radionuclide transport processes considered are the water turnover rates of the Baltic Sea, and radioactive decay and in-growth. The exposed population considered is people in the Baltic region, assumed to consume the total amount of fish captured by commercial fishing. The collective effective dose is calculated using a truncation time at year 1000 following the initial release to the Baltic Sea, as recommended in the regulations.

The collective dose commitment (i.e. integrated over 50,000 years) from C-14 was estimated by multiplying the total releases (from the *timing of releases calculation case*) of C-14 from all waste vaults during the first 1000 years by a conversion factor of 109,000 manSv per PBq. This conversion factor has been used by the UNSCEAR (2000) for estimating the complete collective dose commitment to the global population from releases of C-14 to the atmosphere. It has been calculated under the assumption that the future world population stabilises at  $10^{10}$  people, and that the global inventory of stable carbon does not increase from its present value. Further, according to the UNSCEAR (UNSCEAR 2000) collective doses following releases to soils or to surface oceans are about the same as those for atmospheric releases.

To estimate the incomplete collective dose commitment (i.e. the collective dose integrated over 10,000 years), the complete collective dose commitment was multiplied by 0.75. This is based on estimates (UNSCEAR 2000), that 75% of the complete dose commitment from a single release is delivered within 10,000 years. Estimations of collective dose commitments from C-14 releases made with several different models have given very similar results (UNSCEAR 2000). This consistency between model predictions has been attributed to the long half-life of C-14, relative to its rate of environmental transport, which makes the estimated dose commitments insensitive to the detailed structure of the models or to the values of the parameters used in them (see UNSCEAR 2000 and references therein).

### **8.4 Calculation cases for less probable scenarios**

The less probable scenarios are presented in Section 7.6. The calculation cases identified to analyse the less probable scenarios are presented in the sections below. Unless stated differently, these calculation cases are variants of the *global warming calculation case*.

#### **8.4.1 High inventory calculation case (CCL\_IH)**

The *high inventory calculation case* (CCL\_IH) evaluates the dose from the *high inventory scenario*, Section 7.6.1. The radionuclide inventory used in this scenario accounts uncertainties in the *best estimate inventory* (Table 4-7). Apart from this, the handling of the near-field, the far-field and the biosphere are identical to the *global warming calculation case*.

#### **8.4.2 High flow in the bedrock calculation case (CCL\_FH)**

The *high flow in the bedrock calculation case* (CCL\_FH) evaluates the dose from the *high flow in the bedrock scenario*, Section 7.6.2. In this calculation case, bedrock case 11 (Odén et al. 2014) is used for the radionuclide transport calculations in the geosphere, representing a case with higher water inflow into the waste vaults. In the near-field, this case is implemented by scaling the water flux for each waste vault applied in the *global warming calculation case* with the scaling factors presented in Table 7-12. Apart from this, the handling of the near-field, the far-field and the biosphere are identical to the *global warming calculation case* in the main scenario.

#### **8.4.3 Accelerated concrete degradation calculation case (CCL\_BC)**

The *accelerated concrete degradation calculation case* (CCL\_BC) evaluates the dose from the *accelerated concrete degradation scenario*, Section 7.6.3. In this calculation case, the hydraulic conductivity of the concrete is given in Figure 7-14 and increases earlier or to a greater extent than in the *global warming calculation case*. It means that the water flow in the near-field change. Apart from this, the handling of the near-field, the far-field and the biosphere are identical to the *global warming calculation case*.

#### **8.4.4 Bentonite degradation calculation case (CCL\_BB)**

The *bentonite degradation calculation case* (CCL\_BB) evaluates the dose from the *bentonite degradation scenario*, Section 7.6.4. In this calculation case, the hydraulic properties of the bentonite around the silo are assumed to deteriorate due to the formation of an ice-lens during a period of periglacial climate conditions with the consequences of higher water flow in the silo during a subsequent period of temperate climate conditions.

The evolution of climate-related conditions is based on the *early periglacial calculation case*. The ice-lens is conservatively assumed to form during the first period of periglacial conditions in the *early periglacial calculation case*, i.e. the period between 17,500 and 20,500 AD. During this period of periglacial climate condition, continuous permafrost is assumed to prevail. Furthermore, it is assumed that radionuclide releases from the repository to the geosphere and from the geosphere to the biosphere do not take place during this period. The potential effects of shallow permafrost with taliks are evaluated in the *early periglacial calculation case* (see Section 8.3.2).

Except for the period with ceased flow from 17,500 AD to 20,500 AD and the increased flow in the silo after this period, the handling of the near-field, the far-field and the biosphere are identical to the *global warming calculation case*.

#### **8.4.5 Earthquake calculation case (CCL\_EQ)**

The *earthquake calculation case* (CCL\_EQ) evaluates the dose from the *earthquake scenario*, Section 7.6.5. This scenario is only valid for the silo and is based on the assumption that an earthquake damages the silo structure, leading to an increased water flow. A deterministic simulation approach using best estimate values is applied in this calculation case.

Up to the time of the earthquake, the radionuclide transport is assumed to occur in the same way as in the *global warming calculation case*. After the earthquake event, the concrete barriers in the silo are assumed to have failed, and the water flow increases. The dose calculations are repeated, using the same biosphere model as in the *global warming calculation case*, assuming an earthquake at different time points (every 100<sup>th</sup> year) from closure of the repository up to the end of the assessment period at 102,000 AD.

#### **8.4.6 High concentrations of complexing agents calculation case (CCL\_CA)**

The *high concentrations of complexing agents calculation case* (CCL\_CA) evaluates the dose from the *high concentrations of complexing agents scenario*, Section 7.6.6. In this calculation case, the concentrations of complexing agents, which influence sorption, are higher than in the *global warming calculation case*. In the calculation, the conditions described in Section 7.6.6 were applied to

reflect chemical conditions with higher concentrations of complexing agents in the near-field. Apart from this, the handling of the near-field, the far-field and the biosphere are identical to the *global warming calculation case* of the main scenario.

#### **8.4.7 Wells downstream of the repository calculation case (CCL\_WD)**

The *wells downstream of the repository calculation case* (CCL\_WD) evaluates the dose from the *wells downstream of the repository scenario*, Section 7.6.7. Two types of wells are evaluated as less probable scenario, *wells downstream of the repository* and *intrusion wells* (see below). This calculation case focuses on wells drilled downstream of, but still close enough to be affected by potential releases from the repository. Due to the position of the shoreline, it is not relevant to consider these water wells before year 3000 AD.

The concentrations of radionuclides in drinking and irrigation water are calculated by dividing the amount of radionuclides that reach the well by the amount of water taken from the well. In the biosphere modelling, drilled wells have been identified as a calculation case (BCC5), where dose to the most exposed group is calculated for a *garden plot household*. The handling of the near-field, the far-field and the biosphere are identical to the *global warming calculation case* of the main scenario.

#### **8.4.8 Intrusion wells calculation case (CCL\_WI)**

The *intrusion wells calculation case* (CCL\_WI) evaluates the dose from the *intrusion wells scenario*, Section 7.6.8. At present, and in the near future, the repository footprint (area on the surface vertically above the repository) is located under the sea. It is not relevant to assume that wells for drinking water will be drilled into the repository before the shoreline has passed the repository and the site is high enough above sea level to avoid sea water intruding into the well. Hence these wells are not considered before year 3000 AD.

The concentrations of radionuclides in an intrusion well are assumed to be equal to the pore water concentrations in the backfill. In the BLA-vaults the concentrations are assumed to be equal to the concentrations in free water in the vault.

In the BLA-vaults retention of radionuclides is not accounted for. This leads to high initial concentrations and transport of radionuclides. Such an assumption is normally conservative as more short-lived radionuclides will contribute to the dose. For radionuclide decay-chains where the total radiotoxicity increases with time, this might not be true. For these cases, assuming the radionuclide transport rate was lower, doses might be higher if a well is drilled at a late stage. A variant of the intrusion well calculation case is therefore focusing on the importance on the transport rate, *IBLA intrusion well with alternative transport properties*. In this calculation case alternative transport properties are represented by sorption or solubility limitations which lower the concentrations of radionuclides in the waters. It has been implemented by lowering the concentrations of radionuclides in the waters by up to four orders of magnitude, compared to the normal intrusion well calculation case (CCL\_WI).

In these calculation cases, dose to humans due to radionuclides in the well water is estimated in the same way as for the *wells downstream of the repository calculation case*.

### **8.5 Calculation cases for residual scenarios**

The residual scenarios are presented in Section 7.7. The calculation cases identified to analyse the residual scenarios are presented in the sections below. Unless stated differently, these calculation cases are variants of the *global warming calculation case*.

#### **8.5.1 Loss of barrier function calculation case – no sorption in the repository (CCR\_B1)**

The *loss of barrier function calculation case – no sorption in the repository* (CCR\_B1) evaluates the dose from the *loss of barrier function scenario – no sorption in the repository*, Section 7.7.1.

In this calculation case, it is assumed that radionuclides do not sorb in the repository, which is implemented by setting all sorption partitioning coefficients,  $K_d$  values, for all materials in the near-field to zero. Apart from this, the handling of the near-field, the far-field and the biosphere is identical to the *global warming calculation case* in the main scenario.

### **8.5.2 Loss of barrier function calculation case – no sorption in the bedrock (CCR\_B2)**

The *loss of barrier function calculation case – no sorption in the bedrock* (CCR\_B2) evaluates the dose from the *loss of barrier function scenario – no sorption in the bedrock*, Section 7.7.2.

In this calculation case, it is assumed that radionuclides do not sorb in the bedrock, which is implemented by setting all sorption partitioning coefficients,  $K_d$  values, in the far-field to zero. Apart from this, the handling of the near-field, the far-field and the biosphere are identical to the *global warming calculation case* in the main scenario.

### **8.5.3 Loss of barrier function calculation case – high water flow in the repository (CCR\_B3)**

The *loss of barrier function calculation case – high water flow in the repository* (CCR\_B3) evaluates the dose from the *loss of barrier function scenario – high water flow in the repository*, Section 7.7.3.

In this calculation case, near-field water flows, porosities and diffusivities of the “no barriers” water-flow case are used. Apart from this, the handling of the near-field, the far-field and the biosphere are identical to the *global warming calculation case* in the main scenario.

### **8.5.4 Changed repository redox conditions in SFR 1 calculation case (CCR\_RX)**

The *changed repository redox conditions in SFR 1 calculation case* (CCR\_RX) evaluates the dose from the *changed repository redox conditions in SFR 1 scenario*, Section 7.7.4.

In the main scenario, the chemical conditions in the repository are reducing. This calculation case assumes oxidising conditions in the repository, modelled by applying alternative sorption partitioning coefficients,  $K_d$  values, for redox-sensitive elements Np, Pa, Se, Tc, U and Pu in the near-field. Table 7-3, Table 7-4 and Table 7-5 provide the alternative  $K_d$  values for cementitious materials, bentonite and macadam/crushed rock, respectively. Apart from this, the handling of the near-field, the far-field and the biosphere are identical to the *global warming calculation case* in the main scenario.

### **8.5.5 Extended global warming calculation case (CCR\_EX)**

The *extended global warming calculation case* (CCR\_EX) evaluates the dose from the *extended global warming scenario*, Section 7.7.5. In this calculation case, temperate climate conditions are assumed during the entire assessment time frame. The near-field and far-field models are handled similarly to the *global warming calculation case* in the main scenario, with the exceptions that no periods of periglacial climate domain are included. Also the transport pathways in the near-field and far-field are not expected to be affected by the surface climate, hence, the entire release is assumed to occur in the biosphere object 157\_2 as in the *global warming calculation case*.

The biosphere calculation case *BCC3 extended global warming*, Table 8-4 and Section 7.4.3 in the **Biosphere synthesis report**, is applied. In this calculation case warmer and wetter climate conditions are assumed which affects shore line development, ecosystem production and surface hydrology. Assumptions on human behaviour and land-use are identical to the *global warming calculation case* in the main scenario.

### **8.5.6 Unclosed repository calculation case (CCR\_UR)**

The *unclosed repository calculation case* (CCR\_UR) evaluates the dose from the *unclosed repository scenario*, Section 7.7.6. In this calculation case it is assumed that the repository, for some reason, is abandoned without being properly closed and sealed. The repository will be filled with water within

a few years. Exposure to humans occurs by using water from the tunnel entrance as drinking water as the only considered pathway of exposure. Two variants of radionuclide inventories are considered: one is the inventory disposed of in SFR, the other includes waste intended for the SFL repository that is brought into SFR for temporary storage. The dose is calculated deterministically.

### **8.5.7 Cases related to future human action**

The scenarios related to FHA are presented in details in the **FHA report** and are briefly discussed in Section 7.7.7. The calculation cases, as well as models and the data applied, are also presented in detail in the **FHA report**. The three identified calculation cases referring to the *FHA scenario – drilling into the repository* are briefly summarised below.

#### ***Exposure of the on-site crew during the drilling event (CCFHA1)***

In this calculation case it is assumed that a deep borehole is drilled 1 m into the waste of the repository, selected to be either into the silo, 1BMA, 1BLA or 2BMA. Consequently, radioactive material is brought to the surface in the drill detritus, which causes exposure of workers at the drill site. In the dose calculations, consideration is given to external irradiation, inhalation of dusts which might be generated from the same material and inadvertent ingestion of the material.

The drilling technique used is assumed to be either diamond core drilling using water, which is among the more likely techniques for deep drilling in crystalline rock, or rotary drilling using air, which likely results in higher exposure. It is assumed that drilling proceeds as would be expected if the drilling was done in a typical rock formation; hence, it is assumed that the repository has no effect on the drilling procedure. Furthermore, in reality, there is a pronounced heterogeneity in the spatial distribution of radionuclides and their activities within the repository. However, in this calculation case, the simplified assumption is made that the radionuclide inventory in a waste vault is uniformly distributed. In the silo, it is assumed that the inventory of each radionuclide is uniformly distributed within the dominant materials in the waste packages, consisting of concrete and cement. In the 1BMA and 2BMA vaults, the same approach is used assuming distribution in concrete and cement. For the 1BLA vault, it is assumed that the inventory of each radionuclide is uniformly distributed within the dominant materials consisting in this case of iron/steel and organic material (bitumen, cellulose and other organics). For further details see the **FHA report**.

#### ***Exposure during construction on drilling detritus landfill (CCFHA2)***

In this calculation case, it is assumed that a borehole is drilled that penetrates a waste package in the repository (as for the calculation case *exposure of the on-site crew during the drilling event* above). Thereafter, radioactive material is assumed to be brought to the surface as drill core detritus and is assumed to be disposed of in a shallow uncovered landfill at the drill site. Potential dose consequences are evaluated for a worker during construction on a site that encompasses the contaminated landfill. In the dose calculations, consideration is given to external irradiation from the ground, inhalation of contaminated dust, external exposure from contaminated soil on the skin and inadvertent ingestion of contaminated material.

The same assumptions are adopted regarding the drilling techniques and activity concentrations in the drilling detritus as in the FHA calculation case *exposure of the on-site crew during the drilling event* above, except the calculations are limited to only include the rotary drilling with air. For further details see the **FHA report**.

#### ***Exposure due to cultivation on drilling detritus landfill (CCFHA3)***

This calculation case, *exposure due to cultivation on drilling detritus landfill*, considers the same uncovered contaminated landfill as in FHA calculation case *exposure during construction on drilling detritus landfill* above, including the same radionuclide concentrations. Potential dose consequences



are calculated for a member of a family using the contaminated landfill as a garden plot for cultivating vegetables. The *garden plot household* model in the biosphere is used to calculate the doses from using the contaminated soil for cultivation of vegetables (see Saetre et al. 2013 Section 7.3 and the **Biosphere synthesis report**). The only difference is that it is assumed that the drilling detritus is fully mixed in a 1 metre deep soil. For further details see the **FHA report**.

### 8.5.8 Glaciation and post-glacial conditions calculation case (CCR\_GC)

The *glaciation and post-glacial conditions calculation case* evaluates the dose from the *glaciation and post-glacial conditions scenario* (Section 7.7.8). The scenario is based on the ice-sheet development as described in the *Weichselian glacial cycle climate case* (**Climate report** Section 4.4).

The first glacial period in the *Weichselian glacial cycle climate case*, which occurs between 59,600 and 68,200 AD, is chosen for the evolution of the repository and its environs in the *glaciation and post-glacial conditions scenario*. This glacial period is followed by a period of submerged conditions from 68,200 to 76,200 AD, in accordance with the climate case. During the remaining part of the assessment period temperate climate conditions are assumed.

Based on the *Weichselian glacial cycle climate case*, continuous permafrost at repository depth is assumed to exist prior to the ice sheet advance over the site at 59,600 AD, and the permafrost remains at repository depth until 63,900 AD. This is the starting point of the calculation case. No transport of radionuclides out of the repository is assumed to occur during the period prior to this time. Thus, the radionuclide inventory in SFR at the starting point of this calculation case is determined by the inventory at closure and the radioactive decay that has occurred prior to 63,900 AD.

During the latter part of the glacial period, 63,900 to 68,200 AD, when the bedrock is unfrozen, radionuclides are transported from SFR to the Baltic Sea. Due to the isostatic depression of the bedrock at SFR, a substantial water depth is assumed in this part of the Baltic Sea. Therefore the radionuclides are assumed to spread over a larger part of the Baltic resulting in no accumulation of radionuclides in the sediments in the Forsmark area during this period in the calculation case.

The period from 63,900 AD, when the bedrock has thawed, until the deglaciation of Forsmark at 68,200 AD, has been divided into three parts with respect to groundwater flow, see Table 7-6. During these three parts, the groundwater flow is taken as one, two and three times, respectively, the groundwater flow in temperate terrestrial periods of the *loss of barrier function calculation case – high water flows in the repository* (Section 8.5.3).

During the 8,000 year submerged period following the glacial period, radionuclides transported out of SFR to the Baltic Sea are assumed to accumulate in the sediments above SFR. The period of the calculation case representing the submerged period after deglaciation and the transition to temperate terrestrial conditions, 68,200 AD to 76,200 AD is modelled in the calculation case based on the period from 5000 BC to 3000 AD in the *Weichselian glacial cycle climate case*.

The subsequent temperate period is cautiously assumed to last until the end of the assessment period and the biosphere is here modelled as temperate periods in the main scenario. During this period, the groundwater flow is taken to be the same as in temperate terrestrial periods of the *loss of barrier function calculation case – high water flows in the repository*. In order not to underestimate the chemical and tectonic effects of a glaciation on the geosphere, the releases from the near-field are directed directly to the biosphere, i.e. to biosphere object 157\_2 as in BCC1, which is the basis of the biosphere assessment of this calculation case.

At the end of the glaciation the shoreline is assumed to be identical to the shoreline in Forsmark at 5000 BC with submerged conditions. Thereafter the landscape development is assumed to evolve as the development after the Weichselian glaciation. The biosphere calculation case BCC4 is applied for submerged conditions.

## 8.6 Calculation cases for scenario combinations

### 8.6.1 Scenario combination 1 (CCC\_SC1)

The *Scenario combination 1 calculation case* evaluates the dose from the *Scenario combination 1*, see Section 7.8. The calculation case combines the two calculation cases *high flow in the bedrock calculation case* and the *accelerated concrete degradation calculation case* as described in Section 8.4.2 and Section 8.4.3.

### 8.6.2 Scenario combination 2 (CCC\_SC2)

The *Scenario combination 2 calculation case* evaluates the dose from the *Scenario combination 2*, see Section 7.8. The calculation case combines the two calculation cases *high flow in the bedrock* and the *high concentrations of complexing agents*, as described in Sections 8.4.2. and 8.4.6.

## 8.7 Summary

The calculation cases identified for the main scenario, for less probable scenarios, for residual non-FHA, for (residual) FHA scenarios and for scenario combinations as described in the previous sections are summarised in Table 8-5 to Table 8-8. This summary includes a short description of differences in the applied data sets with respect to the global warming calculation case as the base case.

**Table 8-5. Summary of the calculation cases identified for analysing the main scenario presented in Section 7.4.**

Calculation case	Brief description
CCM_GW Global warming calculation case (Section 8.3.1)	This case, considered as the base case, is defined to assess the <i>global warming climate variant</i> of the main scenario. It is assumed that the radionuclide releases do not begin until 1000 years after closure of the repository. near-field: base case data far-field: base case data biosphere: base case data (BCC1)
CCM_EP Early periglacial calculation case (Section 8.3.2.)	This case is defined to assess the <i>early periglacial climate variant</i> of the main scenario. It differs from the <i>global warming calculation case</i> during the period between 17,500 AD and 20,500 AD in which periglacial climate conditions are assumed here, with releases of radionuclides restricted to taliks. near-field: base case data far-field: base case data biosphere: talik case during early periglacial period (BCC2)
CCM_TR Timing of the releases calculation case (Section 8.3.3)	In this case, the radionuclide release is assumed to commence directly after closure of the repository. near-field: immediate onset of releases from the near-field far-field: base case data biosphere: base case data
CCM_CD Collective dose (Section 8.3.4)	This case is defined to evaluate collective dose for a population in the Baltic region affected by the release of radionuclides to the Baltic Sea and for the global population exposed by C-14 releases to the atmosphere. near-field: immediate onset of releases from the near-field far-field: base case data biosphere: alternative geosphere–biosphere interface and dose models

**Table 8-6. Summary of the calculation cases identified for analysing the less probable scenarios presented in Section 7.6.**

Calculation case		Brief description
CCL_IH	High inventory calculation case (Section 8.4.1)	In this case a radionuclide inventory with higher activity than the best estimate inventory is applied. near-field: radionuclide inventories as 95th percentile of their distribution of uncertainty (Section 7.6.1) far-field: base case data biosphere: base case data
CCL_FH	High flow in the bedrock calculation case (Section 8.4.2)	This case applies higher water flows in bedrock and waste vaults near-field: higher water flows by scaling (Figure 7-14) far-field: higher water flows (bedrock case 11, Section 7.6.2) Odén et al. (2014). biosphere: base case data
CCL_BC	Accelerated concrete degradation calculation case (Section 8.4.3)	In this case it is assumed that the hydraulic conductivity of the concrete increases earlier or to a greater extent than in the <i>global warming calculation case</i> . near-field: accelerated increase of water flows far-field: base case data biosphere: base case data
CCL_BB	Bentonite degradation calculation case (Section 8.4.4)	In this case, the hydraulic properties of the bentonite around the silo are assumed to deteriorate due to the formation of an ice-lens during a period of periglacial climate conditions, with the consequence of higher water flow in the silo during a subsequent period of temperate climate conditions. near-field: after early periglacial period without flows onset of water flows for deteriorated bentonite conditions far-field: base case data biosphere: base case data
CCL_EQ	Earthquake calculation case (Section 8.4.5)	This case assumes increased water flows due to an earthquake damaging the silo structure. near-field: onset of water flows calculated specifically for the silo with earthquake damages far-field: excluded from the model chain (bypassed) biosphere: base case data; dose derived as maximum from all individually evaluated earthquake events
CCL_CA	High concentrations of complexing agents calculation case (Section 8.4.6)	In this case, concentrations of complexing agents are higher than in the <i>global warming calculation case</i> are assumed, implemented in the calculations by increasing the concrete sorption reduction factor. near-field: reduced $K_d$ values (Section 7.6.6) far-field: base case data biosphere: base case data
CCL_WD	Wells downstream of the repository calculation case (Section 8.4.7)	This case considers wells drilled into rock that are located downstream of and close enough to the repository that they are affected by potential releases from the repository. near-field: base case data far-field: base case data biosphere: garden plot land use with alternative well locations
CCL_WI	Intrusion wells calculation case (Section 8.4.8)	This case assumes that a well is drilled in the bedrock straight down into the waste vaults. near-field: base case data far-field: not included in the calculation biosphere: garden plot land use with alternative well locations

**Table 8-7. Summary of the residual scenarios presented in Section 7.7.**

Calculation case		Brief description
CCR_B1	Loss of barrier function calculation case – no sorption in the repository (Section 8.5.1)	In this calculation case, it is assumed that radionuclides are not sorbed in the repository, which is implemented by setting sorption partitioning coefficients for all materials in the near-field to zero. near-field: zero $K_d$ values far-field: base case data biosphere: base case data
CCR_B2	Loss of barrier function calculation case – no sorption in the bedrock (Section 8.5.2)	In this calculation case, it is assumed that no sorption of radionuclides occur in the bedrock, which is implemented by setting all sorption partitioning coefficients in the far-field to zero. near-field: base case data far-field: zero $K_d$ value biosphere: base case data
CCR_B3	Loss of barrier function calculation case – high water flows in the repository (Section 8.5.3)	This case demonstrates the importance of the engineered barriers in the repository to limit the water flow by applying near-field water flows, porosities and diffusivities for completely degraded concrete and bentonite barriers. near-field: “no barriers” water-flow case far-field: base case data biosphere: base case data
CCR_RX	Changed repository redox conditions in SFR 1 calculation case (Section 8.5.4)	This case assumes oxidising conditions in the repository for the redox-sensitive elements. An alternative set of sorption partitioning coefficients in the near-field is used for Tc, Pu, U, Np, Pa and Se. near-field: $K_d$ values for oxidising conditions for redox-sensitive elements far-field: base case data biosphere: base case data
CCR_EX	Extended global warming calculation case (Section 8.5.5)	In this case it is assumed that temperate climate conditions prevail during the entire assessment time frame (i.e. no periods of periglacial climate conditions). near-field: base case data far-field: base case data biosphere: BCC3
CCR_UR	Unclosed repository calculation case (Section 8.5.6)	In this case it is assumed that the repository is abandoned without being closed and sealed and future humans use water from the tunnel entrance as drinking water. near-field: base case data in simplified stirred tank model far-field: not applicable biosphere: ingestion of drinking water only
CCFHA1	Exposure of the on-site crew during the drilling event (Section 8.5.7)	In this case, drilling into the waste vaults brings radioactive material to the surface in the drill detritus. Doses are evaluated for workers at the drill site. near-field: homogenous distribution of radionuclides and materials per waste vault far-field: not applicable biosphere: irradiation (from core detritus), dust inhalation and inadvertent ingestion from core detritus
CCFHA2	Exposure during construction on drilling detritus landfill (Section 8.5.7)	In this case, drilling into the waste vaults brings radioactive material to the surface in the drill detritus which is disposed of in a shallow uncovered landfill at the drill site. Doses are evaluated for a worker during construction on this landfill. near-field: homogenous distribution of radionuclides and materials per waste vault far-field: not applicable biosphere: irradiation (from ground and attached soil), dust inhalation and inadvertent soil ingestion
CCFHA3	Exposure due to cultivation on drilling detritus landfill (Section 8.5.7)	In this case, drilling into the waste vaults brings radioactive material to the surface in the drill detritus which is disposed of in a shallow uncovered landfill at the drill site. Doses are evaluated for a member of a family using the contaminated landfill as a garden plot for cultivating vegetables. near-field: homogenous distribution of radionuclides and materials per waste vault far-field: not applicable biosphere: garden plot land use with detritus inventory distributed in the soil
CCR_GC	Glacial and post-glacial conditions calculation case (Section 8.5.8)	This calculation case studies the potential consequences of glaciations, assessing the consequences of melt water flow during deglaciation and of deteriorated technical and geological barriers thereafter. near-field: no transport until 63,900 years AD, upscaled water flows for melt water flushing, water flows for completely degraded barriers thereafter far-field: not applied biosphere: BCC4, BCC1

**Table 8-8. Summary of calculation cases for scenario combinations presented in Section 7.8.**

Calculation case		Brief description
CCC_SC1	Scenario combination 1 (Section 8.6.1)	This case applies higher water flows in bedrock and waste vaults. The hydraulic conductivity of the concrete increases earlier or to a greater extent than in the <i>global warming calculation case</i> . near-field: accelerated increase of water flows and higher water flows by scaling far-field: higher water flows (bedrock case 11, Section 7.6.2) biosphere: base case data
CCC_SC2	Scenario combination 2 (Section 8.6.2)	This case applies higher water flows in bedrock and waste vaults. Augmented concentrations of complexing agents are implemented by increasing the concrete sorption reduction factor with respect to the global warming CC. near-field: higher water flows by scaling (Figure 7-14), reduced $K_d$ values (Section 7.6.6) far-field: higher water flows (bedrock case 11, Section 7.6.2) biosphere: base case data



## 9 Radionuclide transport and dose calculations

### 9.1 Introduction

This chapter presents results from calculations of annual effective doses to humans and absorbed dose rates to non-human biota that were carried out to analyse the scenarios presented in Chapter 7. The models and calculation cases used to perform this analysis are described in Chapter 8. The doses derived for the scenarios and the probability of occurrence of these scenarios have been subsequently used for estimating the radiological risk associated with the repository; quantification of the risk is presented in Chapter 10.

Details of the approach for the assessment of annual effective doses to humans from releases to the biosphere can be found in Saetre et al. (2013). For the analysis of most scenarios, both deterministic and probabilistic simulations have been carried out. A deterministic approach was used for the *earthquake scenario*, the *unclosed repository scenario* and scenarios related to future human actions (FHA). The reason for using deterministic calculations in the *earthquake scenario* is that the calculations were repeated many times assuming an earthquake event to happen every 100 years beginning from repository closure; hence, a probabilistic approach would not have been feasible with the available computational capacity. For the highly stylised models applied for the assessment of the *unclosed repository scenario* and scenarios related to FHA, deterministic simulations are deemed to be more suitable for methodological reasons. Moreover, the results from the *unclosed repository scenario* and scenarios related to FHA are not propagated to the risk assessment. The same holds for the assessment of collective dose and the assessment of dose rates to non-human biota. For the probabilistic simulations, parameter values were randomly sampled from pre-determined statistical distributions. For the deterministic simulations, a best estimate (BE) value was applied for each input parameter.

Humans exposure to radionuclides dispersed in the environment is modelled for representative individuals of four distinct potentially most exposed groups in SR-PSU (further described in Section 7.4.5). These groups are assumed to live in or utilise natural resources in the areas associated with accumulation of radionuclides from the SFR repository. Each group is associated with a unique variant of land-use and corresponding exposure pathways: *Drained-mire farmers* (DM) cultivate a drained mire in a biosphere object, whereas *Infield-outland farmers* (IO) and *Garden plot household* (GP) use different natural resources (e.g. hay, seaweeds, biofuels and irrigation water) from a biosphere object. Because of the low productivity of non-cultivated food items, a larger resource area is required to sustain *Hunters and gatherers* (H&G), and consequently this group forage multiple biosphere objects for food. *Hunters and gatherers* is assumed to be the only exposed group that is sustainable also in periglacial climate conditions (the exposed groups are further described in Section 7.4.5).

In a probabilistic assessment, a distribution of annual effective doses is obtained at every time step for each of the potentially most exposed groups (in each biosphere object). The representative value of the distribution of annual effective dose is its arithmetic mean and this is used for comparing the exposure of the groups and evaluating the maximum dose with respect to the exposed groups, biosphere objects and time. The representative annual effective dose in a biosphere object at a time step is the maximum (mean) effective dose for the most exposed group relevant for the prevailing climatic conditions. The representative value for annual effective dose for the entire biosphere (at the given time step) is the maximum of the representative values for the biosphere objects; this is the relevant dose quantity from a calculation case to be propagated to the risk assessment. The peak value of this dose quantity, i.e. the maximum of all calculated arithmetic means of annual effective dose for any group, biosphere object and time step, is here referred to as the *peak annual effective dose*, or, more briefly, the *peak dose*, of the respective calculation case. The peak annual effective dose may be derived for radionuclide releases from each individual waste vault or from the entire repository. For a deterministic simulation, the arithmetic mean of a distribution is replaced by the single obtained dose value noted in the discussion above.

An overview of the annual effective doses to humans and absorbed dose rates to non-human biota is presented in the following sections. A detailed presentation of all the results can be found in the **Radionuclide transport report**. The assessment of human exposure is presented for the variants of the main scenario, the less probable scenarios, the residual scenarios and scenario combinations in Sections 9.2 to 9.5. For each scenario, the calculation cases defined in Chapter 8 are used. In Section 9.6, the peak doses to humans are summarised. The assessment of exposures to non-human biota is presented in Section 9.7.

## 9.2 Results for the main scenario

The assessment of the main scenario (Section 7.4) comprises the assessment of its two variants, the *global warming variant* and the *early periglacial variant*. The first variant is assessed by evaluating two calculation cases, the second variant by a single calculation case. An overview of the main results obtained for the main scenario is presented below.

### 9.2.1 Global warming variant of the main scenario

The external conditions for the *global warming variant of the main scenario* are described in Section 7.4.1. The *global warming variant of the main scenario* is assessed by two calculation cases, the *global warming calculation case* and the *timing of the releases calculation case*. In the first calculation case, releases of radionuclides from the repository start 1,000 years after closure, at the end of the period when the areas of potential release from the geosphere are submerged. In the second calculation case, the releases start right at the beginning of the assessment period.

Time series of annual effective doses in biosphere object 157\_2, in which the releases to the biosphere take place, are shown in Figure 9-1 for the two calculation cases in the *global warming variant of the main scenario*. The maximum annual dose is for the first about 1,000 years after closure obtained for *hunters and gatherers*. Thereafter and up to 4500 AD the highest dose is obtained by *garden plot household* and *infield-outland farmers*. After 4500 AD, the land has emerged enough over the sea to allow for draining and cultivating and then, and for the rest of the temperate periods of the analysed period, the group *drained-mire farmers* receives the highest annual dose. For periglacial climate conditions, hunting and gathering is the only possible form of land-use. During the periods of time when conditions of climate and landscape development allow all variants of land-use, there is a clear graduation of exposure increasing from *hunters and gatherers* to *garden plot household* and *infield-outland farmers* to *drained-mire farmers*.

The highest doses during temperate climate conditions occur most of the time, including the point in time when the peak dose is reached, in biosphere object 157\_2. Only in the period from 15,000 AD to 35,000 AD is the level of exposure slightly higher in biosphere object 157\_1. Biosphere object 157\_1 is situated downstream of 157\_2. In contrast to the latter, object 157\_1 goes through a lake stage, whereas 157\_2 emerges from the sea directly as a mire. A thicker layer of peat develops in the lake basin of biosphere object 157\_1, and consequently this object has a higher accumulation capacity for certain radionuclides, e.g. for Mo-93, than object 157\_2. This is the reason why the dose is higher in the downstream biosphere object 157\_1 between 15,000 AD and 35,000 AD (Figure 9-1).

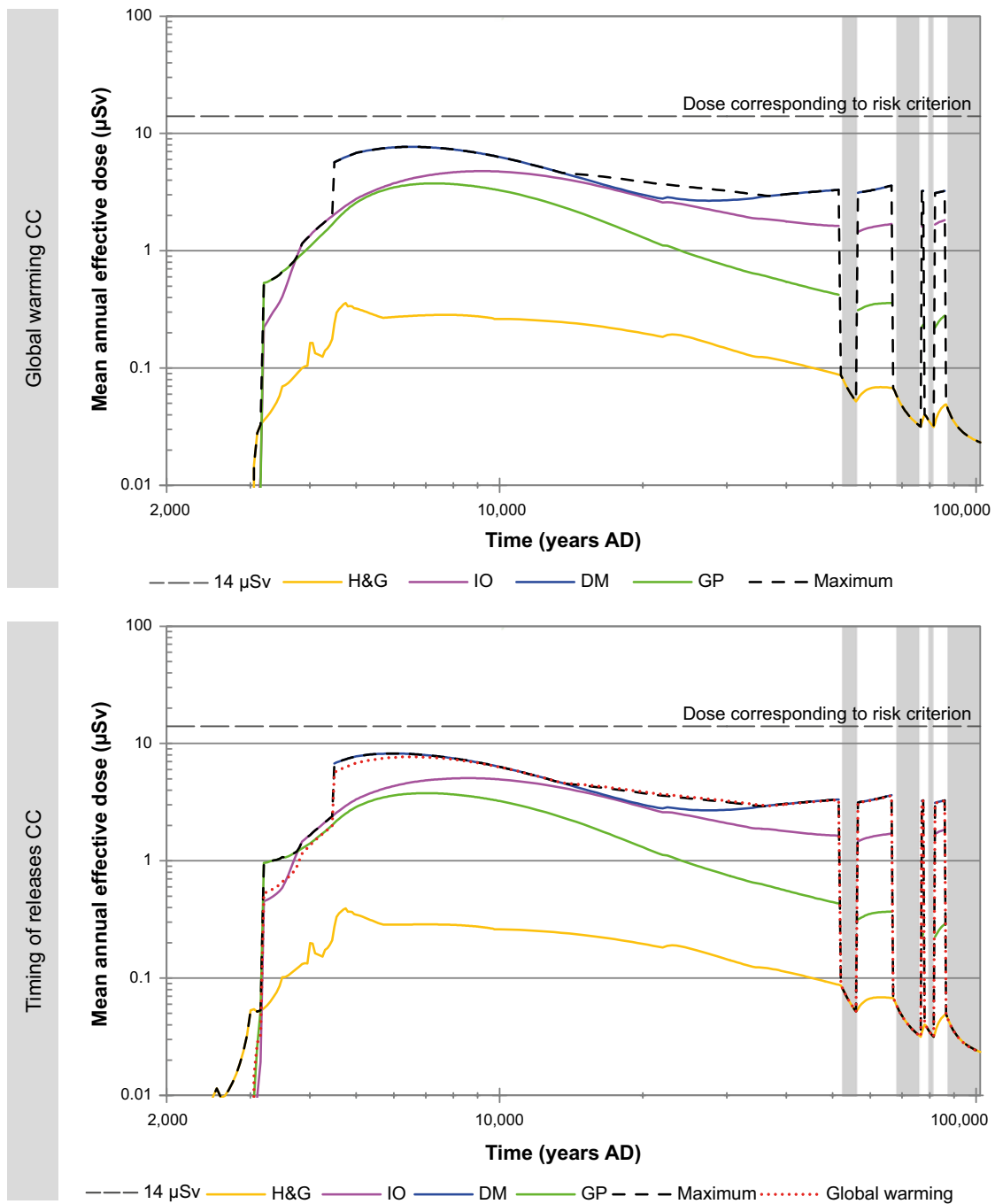
To capture the degradation of engineered barriers, the near-field is adapted in the simulation in, for example, the following way at 22,000 AD:

- sorption in the near-field in the 1-2BTF and BRT vaults drop due to the degradation of concrete ( $K_d$  values controlling sorption in the near-field changes from state II to state IIIa, see Section 7.4.3),
- corrosion rate of the RPV in BRT increases due to decreased pH as a result of degradation of concrete (corrosion rate changes from 0.05  $\mu\text{m}/\text{yr}$  to 2.8  $\mu\text{m}/\text{yr}$ ), and
- water flow increases significantly in the engineered barriers of 1BMA and 2BMA (water flow change from a moderately to a severely degraded state of concrete).

The changed conditions in the near-field have a visible impact on the evolution of dose quantities and the falling trend of annual effective dose for *infield-outland farmers*, the *garden plot household* and *hunters and gatherers* is temporarily interrupted at around 22,000 AD (Figure 9-1). For *drained-mire farmers* of biosphere object 157\_2 the trend is even inverted from a decreasing to a long-lasting increasing trend, but without exceeding the initial peak value and with the trend being interrupted by periods of periglacial climate.

The dynamics of the dose curves mainly reflects the dynamics of the radionuclide releases from the repository. The peak annual effective dose in the *timing of the releases calculation case* is reached, as a consequence of the earlier start of release, 500 years earlier (6000 AD) than in the *global warming calculation case* (6500 AD). The maximum is slightly higher in the *timing of the releases calculation case* than in the *global warming calculation case* (8.2  $\mu\text{Sv}$  compared with 7.7  $\mu\text{Sv}$ ). Apart from these slight shifts, the time series of the two calculation cases do not deviate significantly (Table 9-1 and Figure 9-1).





**Figure 9-1. Global warming variant of the main scenario.** Arithmetic mean of the annual effective dose for the different exposed groups in biosphere object 157\_2 and maximum annual effective dose for the **global warming calculation case (top)** and the **timing of releases calculation case (bottom)** of the **global warming variant of the main scenario**. The maximum annual effective dose (red dotted and black dashed) accounts for the dominance of biosphere object 157\_1 from 15,000 to 35,000 AD. H&G – **hunters and gatherers**, IO – **infield–outland farmers**, DM – **drained-mire farmers**, and GP – **garden plot household**. The unshaded areas correspond to temperate climatic conditions and the grey shaded areas to periglacial conditions with continuous permafrost.

The group of *hunters and gatherers* is particularly adaptive to changing external conditions, i.e. landscape development and climate change, and their exposure is sensitive to threshold events in the evolution of these conditions. This sensitivity depends partially on the dominating impact of C-14 on this group's exposure with the carbon cycling depending heavily on external conditions. This explains the pronounced response of the annual dose to *hunters and gatherers* in the initial phase of landscape development when submerged areas become terrestrial. In both calculation cases, this group reaches

its peak dose at 4750 AD. During periglacial periods, only the group of *hunters and gatherers* is assumed to be present at the site, but with reduced food resources. As a consequence, the maximum annual dose drops to significantly lower levels during these periods of time.

The peak annual effective dose of the two calculation cases is presented in Table 9-1, together with the year of occurrence, the contributions from the waste vaults and the most dose contributing radionuclides. Information as to which exposed group incurred the peak annual dose and in which of the biosphere objects is also presented in Table 9-1.

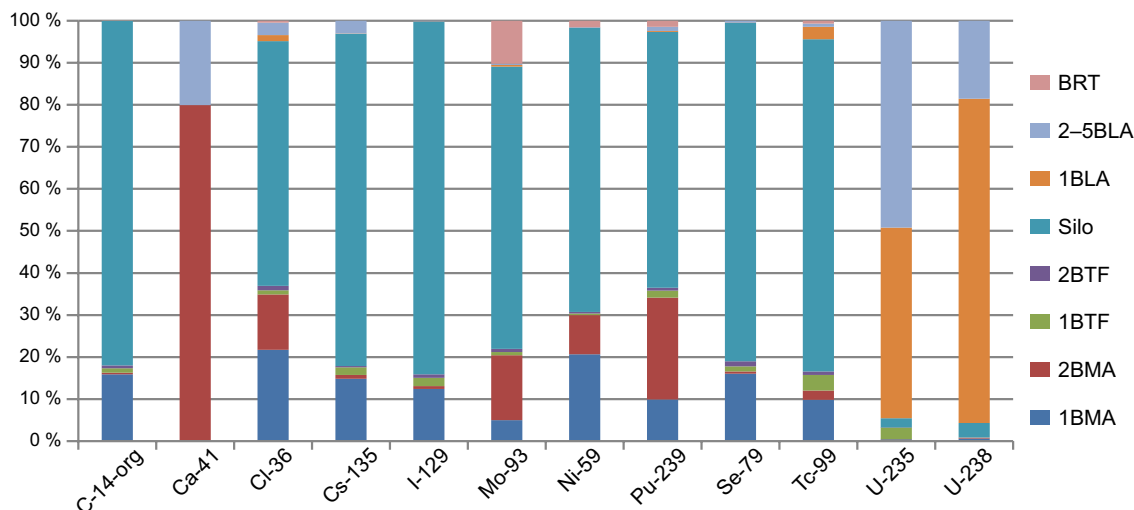
The peak doses are dominated by a few radionuclides that can be categorised in two groups; 1) those that have a high mobility: Mo-93, organic C-14, I-129 and Cl-36 responsible for more than 80% of the peak dose, and 2) Uranium and its progeny responsible for more than 7% of the peak dose. Besides these, Ca-41 contributes nearly 3% in both calculation cases.

Concerning the dose distribution between the various waste vaults, the silo contributes some 45%, 1BMA and 2BMA about 25%, 1BLA between 9 and 12%, 1BTF and 2BTF some 9%, 2-5BLA about 5%, and BRT 4%. The largest difference in relative dose contribution for the two calculation cases is to be observed for 1BLA contributing a 9.3% in the *timing of the releases calculation case* versus 11.9% in the *global warming calculation case*. This result strongly correlates with the distribution of the inventories of U-235 and U-238 across the waste vaults as seen in Figure 9-2, and the dose contribution of these two radionuclides, 6.7% in the *timing of the releases calculation case* versus 9.1% in the *global warming calculation case*.

The data given in Table 9-1 shows that both calculation cases for the *global warming variant of the main scenario* complies with the risk criterion. Due to the different assumed starting years of the near-field releases, peak dose is about 6% higher in the *timing of the releases calculation case* and occurs 500 years earlier than in the *global warming calculation case*.

**Table 9-1. Peak annual effective dose obtained for the two calculation cases of the *global warming variant of the main scenario*. In addition to peak annual effective dose the table includes: the year when the peak dose occurs, contribution to the peak dose from the different waste vaults, contribution to the peak dose from different radionuclides (where 'Others' is the sum of all radionuclides that contribute less than 1% each), the most exposed group, and biosphere object where the peak dose occur.**

Annual dose [ $\mu$ SV]	Year [AD]	Contribution from waste vault (%)	Contribution from radionuclide (%)	Exposed group (biosphere object)
<b>Global warming calculation case</b>				
7.7	6500	Silo (45.3)	Mo-93 (57.7)	Drained-mire farmer (Object 157_2)
		1BMA (15.8)	C-14-org (17.9)	
		1BLA (11.9)	U-238 (6.4)	
		2BMA (8.4)	I-129 (5.8)	
		2BTF (5.0)	Cl-36 (3.3)	
		BRT (4.2)	U-235 (2.7)	
		1BTF (4.1)	Ca-41 (2.8)	
		5BLA (1.4)	Others (3.4)	
		2BLA (1.4)		
		4BLA (1.3)		
		3BLA (1.3)		
<b>Timing of the releases calculation case</b>				
8.2	6000	Silo (45.8)	Mo-93 (61.4)	Drained-mire farmer (Object 157_2)
		1BMA (16.1)	C-14-org (17.9)	
		2BMA (9.9)	I-129 (5.6)	
		1BLA (9.3)	U-238 (4.7)	
		2BTF (5.2)	Cl-36 (3.2)	
		BRT (4.3)	Ca-41 (2.6)	
		1BTF (4.3)	U-235 (2.0)	
		5BLA (1.3)	Others (2.7)	
		2BLA (1.3)		
		3BLA (1.3)		
		4BLA (1.2)		



**Figure 9-2.** Distribution of initial inventories across waste vaults for dominating radionuclides.

Time series of doses for the five vaults contributing most to the peak annual dose in the *global warming calculation case* are presented in Figure 9-3 to Figure 9-7, showing also the contributions of dominating radionuclides. The set of dominating radionuclides that contributes to peak dose differs between the waste vaults. This is mainly due to differences in waste vault inventories; see Figure 9-2 for the distribution of initial inventories of dominating radionuclides across waste vaults.

For the silo, the peak dose occurs at 7150 AD with Mo-93 as main contributor followed by organic C-14, I-129 and Cl-36 (Figure 9-3). After 39,000 AD Ni-59 contributes most to dose, at that time however, the doses are about one order of magnitude lower than the peak dose.

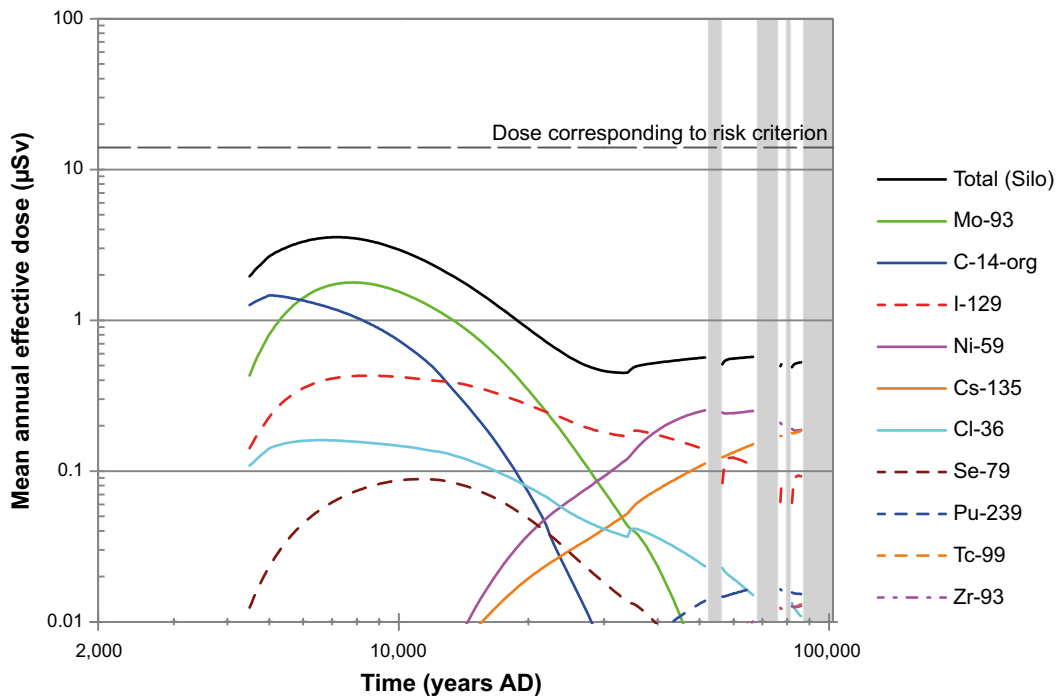
#### **Annual doses to drained-mire farmers in biosphere object 157\_2**

The annual dose for the group of *drained-mire farmers* due to the waste in the 1BMA vault is initially dominated by C-14 and Mo-93 followed by I-129 and Cl-36, but from 18,000 AD Ni-59 dominates the doses from 1BMA (Figure 9-4). The dose decreases until concrete degradation leads to lower sorption and higher water flow around 22,000 AD. This transition in hydraulic and sorption properties has a particular high impact on poorly sorbing radionuclides such as I-129, Cl-36 and Mo-93. After 22,000 AD, annual doses increase, with a break during a period of periglacial climate, until the end of the second period of temperate climate conditions when the peak dose from 1BMA is reached at 66,500 AD. At this point in time, Ni-59 is the dominating radionuclide, followed by Cs-135, Pu-239, Tc-99 and the decay product Ra-226. At the end of the fourth temperate period (87,000 AD), the dose from 1BMA is still close to its peak value.

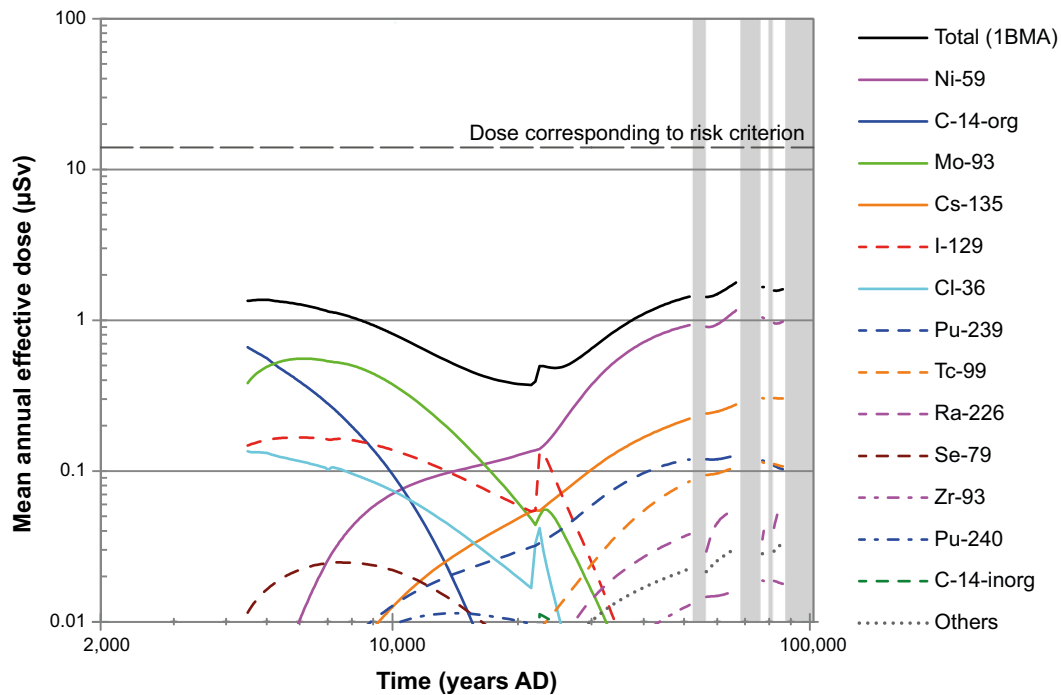
For 1BLA, U-238, U-235 and its progeny (Pa-231 and Ac-227) together with Mo-93 are the radionuclides that contribute most to the peak dose at 6550 AD (Figure 9-5). Most of the uranium inventory in the repository can be found in the 1BLA vault (Table 4-6 and Figure 9-2).

For 2BMA, the peak dose is reached at 10,500 AD and is dominated by Mo-93, followed by Ca-41 and Cl-36 (Figure 9-6). Between 16,500 AD and 62,500 AD, Ca-41 becomes the most dominating radionuclide (80% of the Ca-41 inventory can be found in 2BMA, see Figure 9-2). After 62,500 AD, Ni-59 contributes the most to the dose. The changing conditions at 22,000 AD induced by concrete degradation have a less significant impact than for 1BMA and do not sustainably alter the decreasing trend of annual dose. The dose becomes nearly constant in the third and fourth periods of temperate climate conditions. At the end of the last temperate period at 87,000 AD the annual dose has fallen less than one order of magnitude with respect to the peak dose.

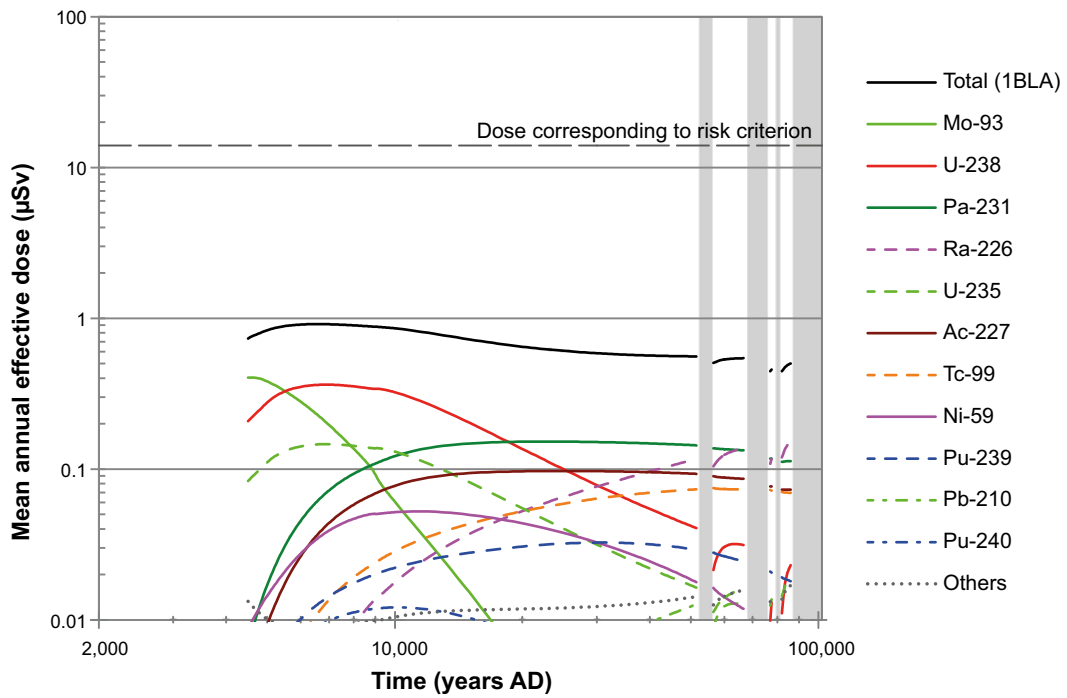
The peak dose for 2BTF is reached 4800 AD and is dominated by Mo-93 followed by I-129 and C-14 (figure 9-7). At 11,000 AD Ni-59 becomes the dose dominating radionuclide for 2BTF and remains so for the rest of the assessment period.



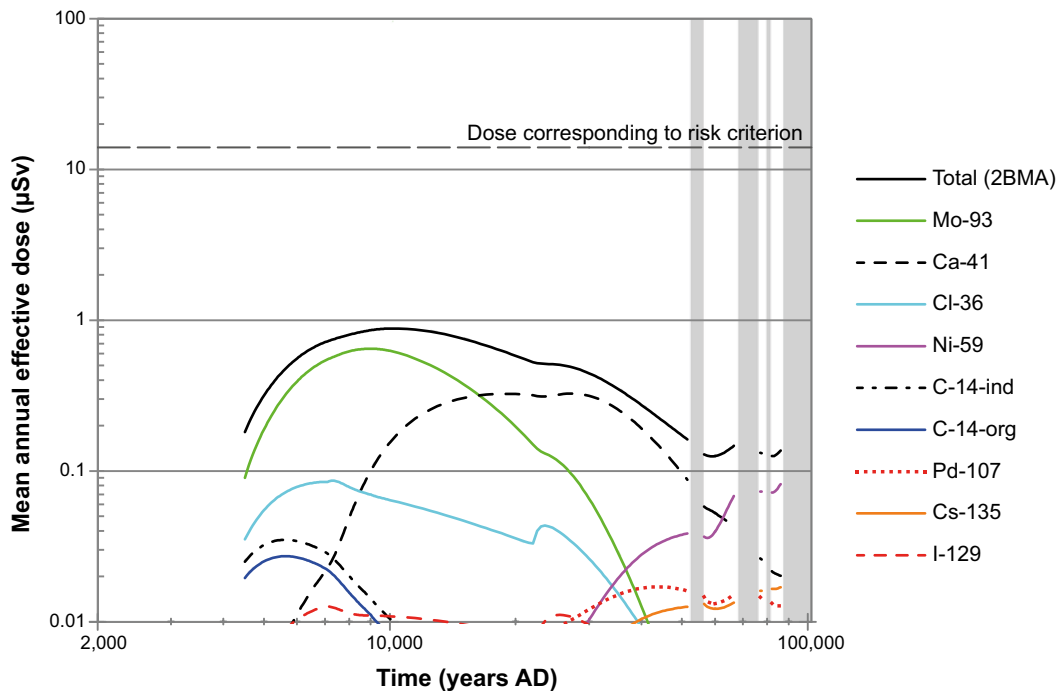
**Figure 9-3.** Arithmetic mean of the annual dose to the *drained-mire farmers* exposed group in object 157\_2. Values are shown for doses from releases from the *silo* in the *global warming calculation case*. The unshaded areas correspond to temperate climatic conditions and the grey shaded areas to periglacial conditions with continuous permafrost.



**Figure 9-4.** Arithmetic mean of the annual dose to the *drained-mire farmers* exposed group in object 157\_2. Values are shown for doses from releases from *1BMA* in the *global warming calculation case*. The unshaded areas correspond to temperate climatic conditions and the grey shaded areas to periglacial conditions with continuous permafrost.



**Figure 9-5.** Arithmetic mean of the annual dose to the *drained-mire farmers* exposed group in object 157\_2. Values are shown for doses from releases from **1BLA** in the **global warming calculation case**. The unshaded areas correspond to temperate climatic conditions and the grey shaded areas to periglacial conditions with continuous permafrost.



**Figure 9-6.** Arithmetic mean of the annual dose to the *drained-mire farmers* exposed group in object 157\_2. Values are shown for doses from releases from **2BMA** in the **global warming calculation case**. The unshaded areas correspond to temperate climatic conditions and the grey shaded areas to periglacial conditions with continuous permafrost.

### Impact of parameter uncertainty

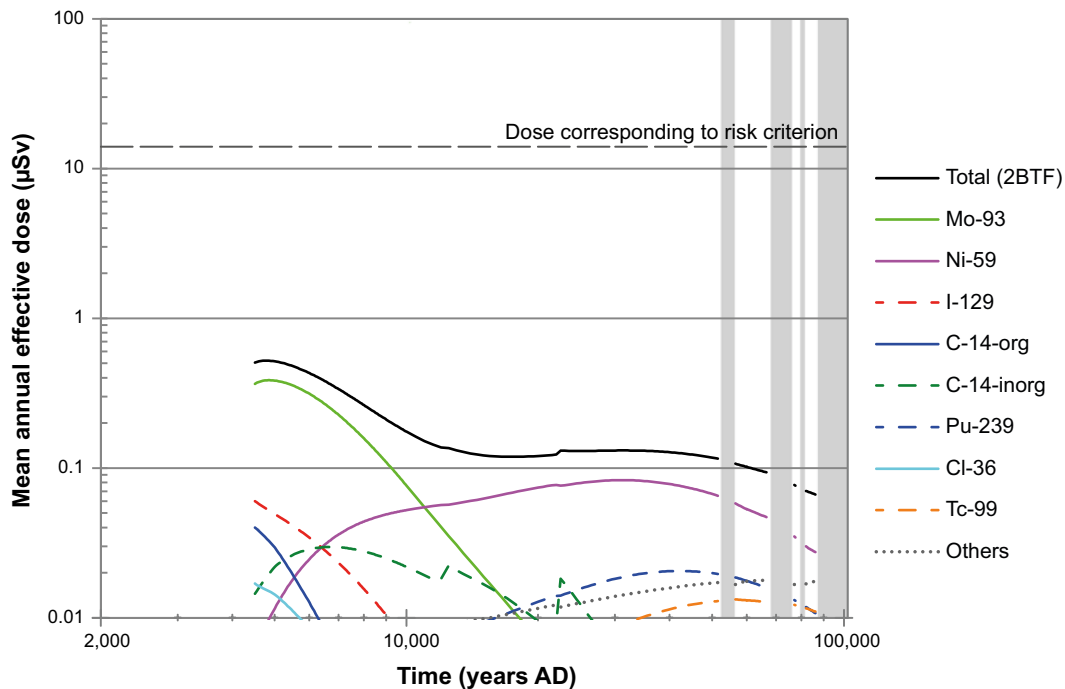
In the above results, the annual effective doses are derived as the arithmetic mean of an annual dose distribution obtained from probabilistic (Monte Carlo) simulation. The distribution of the annual dose is characterised by its median, 5th and 95th percentiles and its arithmetic mean to demonstrate its range of variation with respect to the variation of input parameters. The derived statistics characterising the variation of the maximum annual dose are shown in Figure 9-8 for the *global warming calculation case*. For comparison with the derived statistics the deterministically obtained value (from best estimate input data, BE) of the maximum annual dose for the different potentially exposed groups at each time step in the simulation are also shown.

The arithmetic mean is always higher than the median, which in turn is higher than the deterministically obtained dose (applying best estimate values for all input parameters). The maximum annual dose in the calculation cases for the *global warming calculation case* is obtained for *drained-mire farmers* in the areas of biosphere objects 157\_2 (except for the initial period up to 4500 AD when other exposed groups receive the highest dose and during the period 15,000 AD to 35,000 AD when the highest dose is obtained in biosphere object 157\_1). During periglacial climate conditions, the most exposed group is *hunters and gatherers* who are foraging in all biosphere objects and are not constrained by a specific biosphere object. The range from the 5th to the 95th percentile is about one order of magnitude during the period when peak dose occurs and is about one and a half orders of magnitude at the end of the assessment period.

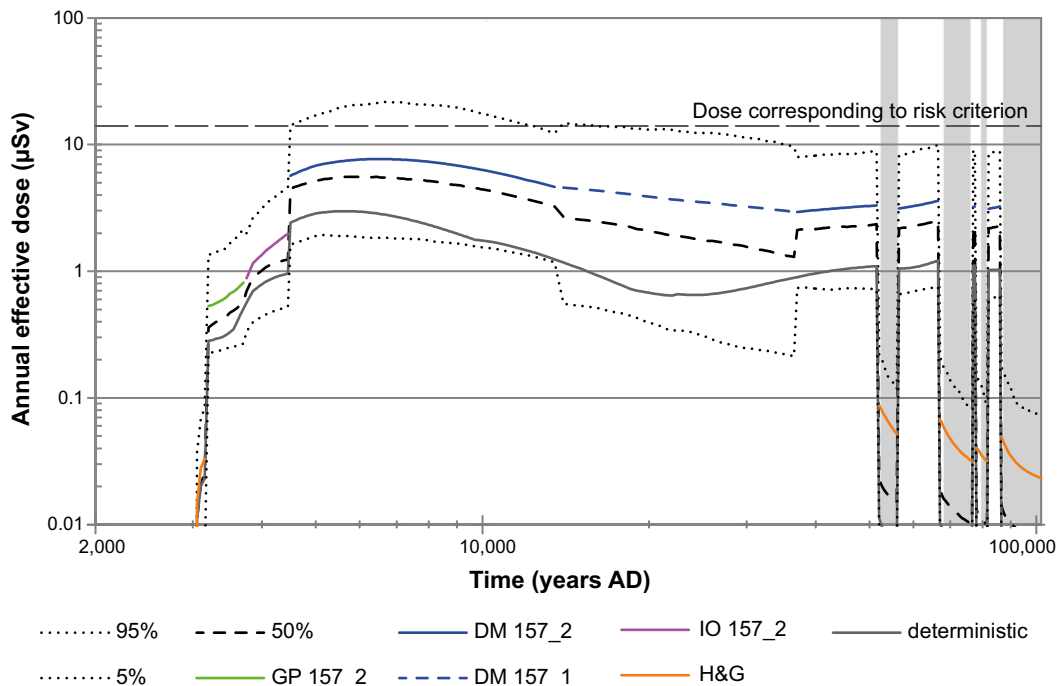
From 15,000 AD to 35,000 AD, when maximum dose is defined by biosphere object 157\_1, the range of uncertainty determined by the two percentiles rapidly increases and the spread between the percentiles is about one and a half orders of magnitude during this period. It is not surprising that the range of variability becomes larger when the length of the modelled path of radionuclide transport in the biosphere increases (157\_1 is further away from the repository than 157\_2) and more input parameters influence the result.

The peak arithmetic mean exceeds the peak deterministic value by nearly half an order of magnitude. This can be interpreted as a quantified measure of the effect of input parameter uncertainty on the assessment of long-term safety.

Results of similar analyses for all scenarios are presented in the **Radionuclide transport report**.



**Figure 9-7.** Arithmetic mean of the annual dose to the *drained-mire farmers* exposed group in object 157\_2. Values are shown for doses from releases from 2BTF in the *global warming calculation case*. The unshaded areas correspond to temperate climatic conditions and the grey shaded areas to periglacial conditions with continuous permafrost.



**Figure 9-8.** Arithmetic mean (DM 157\_2, DM 157\_1, H&G, GP 157\_2, IO 157\_2) together with median (50%), 5th and 95th percentiles of the annual dose to a representative individual of the most exposed group for each time point in the **global warming calculation case**. The dose from the deterministic simulation applying best estimate values is also included for comparison. DM – drained-mire farmers, H&G – hunters and gatherers, IO – infield–outland farmers, GP – garden plot household, and 157\_1 and 157\_2 refers to the different biosphere objects. The unshaded areas correspond to temperate climatic conditions and the grey shaded areas to periglacial conditions with continuous permafrost.

## 9.2.2 Early periglacial variant of the main scenario

The *early periglacial variant of the main scenario* does not differ from the *global warming variant of the main scenario* except for a period of periglacial conditions with shallow permafrost in Forsmark during a period of minimum insolation around 17,500 AD to 20,500 AD (see Section 7.4.1). During the periglacial period, discharges of deep groundwater, and hence releases of radionuclides, will be restricted to taliks (unfrozen areas in the otherwise frozen landscape). Due to the similarities with the *global warming variant of the main scenario* beyond the end of the early periglacial period at 20,500 AD, it is sufficient to analyse the *early periglacial variant* with a calculation case that ends at 20,500 AD. Since the results in this calculation case up to 17,500 AD are identical with the results in the *global warming calculation case* (Section 9.2.1), the discussion below addresses only the period of periglacial conditions.

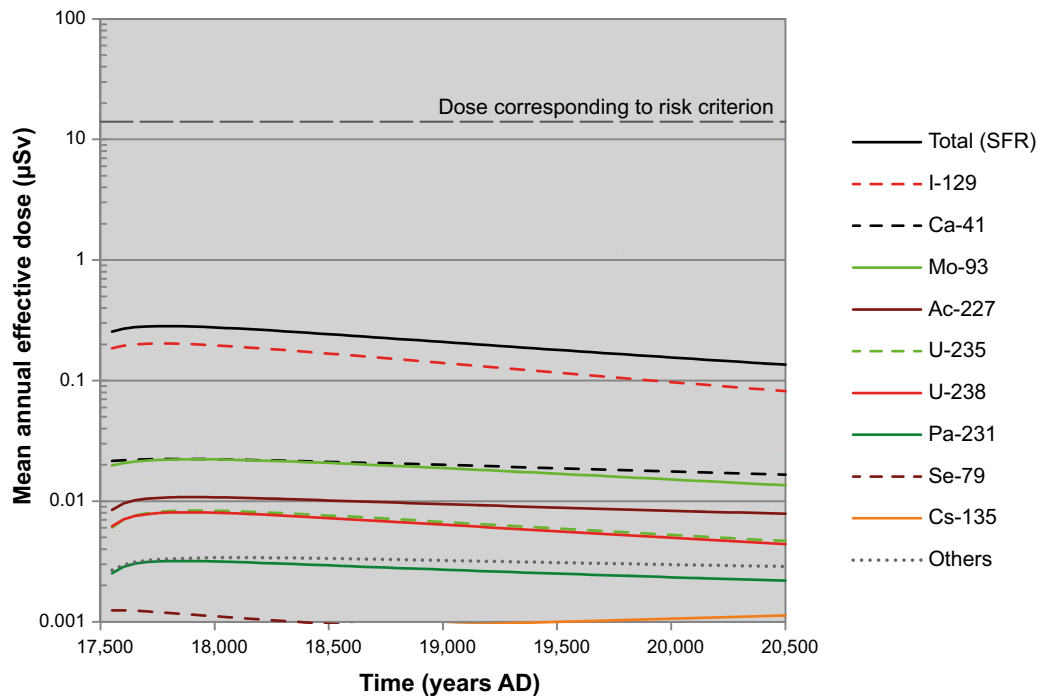
During the periglacial period, discharge is assumed to reach biosphere objects 114 (lake) and biosphere object 157\_1 (mire). Biosphere object 114 are not reached by radionuclide discharge from SFR prior to the periglacial period whereas biosphere object 157\_1 receives radionuclides from upstream biosphere 157\_2 during the temperate periods prior to the periglacial period. The simulations show that the peak annual dose is much lower for biosphere object 114 than for biosphere object 157\_1, mainly due to radionuclides accumulated in biosphere object 157\_1 during temperate conditions. A summary of the results is presented only for biosphere object 157\_1 (Figure 9-9 and Table 9-2).

As already discussed for periglacial periods in the *global warming variant of the main scenario*, it is assumed that *hunters and gatherers* is the only potentially exposed group under periglacial conditions. However, in the *early periglacial variant of the main scenario*, releases take place during the early periglacial period (17,500 AD–20,500 AD); this is for the assumption that permafrost does not reach as deep in the early periglacial period as in the later periglacial periods (see Figure 7-2). Taking this into account, and the fact that in the *early periglacial variant of the main scenario* periglacial conditions occur earlier than in the *global warming calculation variant* of the main scenario, it is reasonable to expect that doses will be higher during the periglacial period in the *early periglacial variant of the main scenario* (17,500 AD – 20,500 AD) than in the *global warming variant of the*

*main scenario* (52,000 AD – 57,000 AD). The results obtained confirm this, which becomes evident by comparing annual dose during periods of the periglacial domain in Figures 9-1 (below 0.1  $\mu\text{Sv}$ ) with annual dose in Figure 9-9 (peak dose of 0.28  $\mu\text{Sv}$ ). The peak dose during the periglacial period 17,500 AD to 20,500 AD for the *early periglacial variant of the main scenario* is nevertheless well below the peak dose for the *global warming variant of the main scenario*.

### 9.2.3 Collective dose

Calculations to estimate the collective dose have also been performed in the safety assessment, focusing on potential releases during the first 1,000 years after closure of the repository. The calculations are described in Section 8.3.4. Collective doses resulting from releases during the first 1,000 years after closure of the repository were calculated using the releases from the geosphere obtained for the *timing of the releases calculation case* (see Section 9.2.1).



**Figure 9-9.** Arithmetic mean of annual dose for the *hunters and gatherers* exposed group in object 157\_1 and the annual doses for the most contributing radionuclides for the *early periglacial variant of the main scenario* during the periglacial period between 17,500 AD and 20,500 AD.

**Table 9-2.** Peak annual effective dose during the periglacial period 17,500 AD to 20,500 AD to a representative individual from the most exposed group obtained for the *early periglacial variant of the main scenario*.

Annual dose [ $\mu\text{Sv}$ ]	Year [AD]	Contribution from waste vault (%)	Contribution from radionuclide (%)	Exposed group (biosphere object)
0.28	17,800	Silo (59.4)	I-129 (71.7)	Hunters and gatherers
		1BMA (16.6)	Ca-41 (7.9)	(Object 157_1)
		1BLA (9.5)	Mo-93 (7.8)	
		2BMA (8.1)	Ac-227 (3.8)	
		1BTF (1.3)	U-235 (2.9)	
		5BLA (1.1)	U-238 (2.8)	
		4BLA (1.0)	Pa-231 (1.1)	
		2BLA (0.9)	Others (1.9)	
		3BLA (0.8)		
		2BTF (0.8)		
		BRT (0.2)		



The collective dose was calculated for two populations, 1) for the global population due to C-14 releases to the atmosphere, and 2) for the population around the Baltic Sea due to radionuclide releases to the Baltic Sea and subsequent exposure of the population by ingestion of fish.

The collective dose to the global population was calculated to be 2.5 manSv, and the collective dose to the population around the Baltic Sea was 0.15 manSv with a 96% contribution from C-14 and a 3% contribution from Ag-108m. Since these calculations are based on potential releases during the first 1,000 years after closure, there is a contribution from short-lived radionuclides in the collective dose for the Baltic population. However, the contributions from short-lived radionuclides are insignificant for the total collective dose: the collective doses from Ni-63, Cs-137, Pu-238, Sr-90 and H-3 are all below  $1 \cdot 10^{-6}$  manSv.

## 9.3 Results for the less probable scenarios

The less probable scenarios are described in Section 7.6. The results of the calculations of annual effective doses to humans for these scenarios are presented in Sections 9.3.1 to 9.3.8. The probabilities of occurrence for these scenarios are not included in the results shown in this chapter but are instead presented in Chapter 10.

### 9.3.1 High inventory scenario

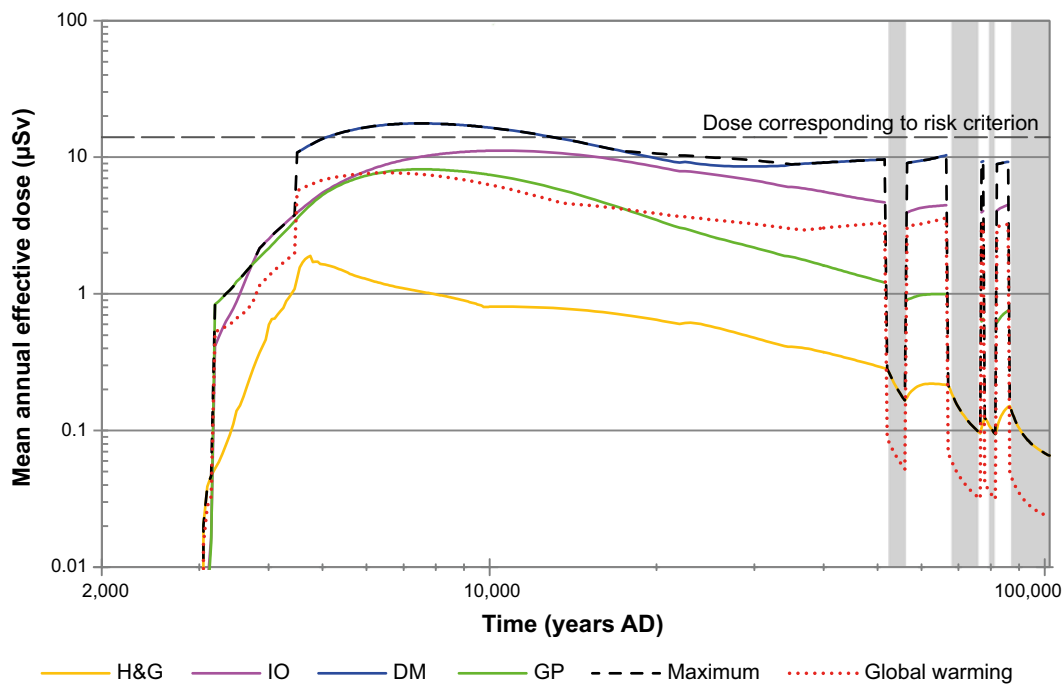
The *high inventory scenario* is described in Section 7.6.1. The inventory of a radionuclide for this scenario is derived as the 95th percentile of its distribution of inventory activity; the inventory data are presented in Chapter 4 (Table 4-7).

The evolution of the annual dose for the exposed groups in biosphere object 157\_2, and for the maximum dose for all biosphere objects, are similar to the calculation cases of the *global warming variant of the main scenario* with the value increased by up to 10  $\mu$ Sv (Figure 9-10). The peak dose of 17.7  $\mu$ Sv occurs 1,000 years later at 7500 AD than in the *global warming calculation case*, see Table 9-3. *Drained-mire farmers* is the most exposed group and receives the highest annual dose.

The relatively weak temporal variation of maximum dose during the simulation period after the peak, except for periods of the periglacial domain, is also similar to the *global warming calculation case*. The decreasing trend in maximum dose during periods of the temperate domain is converted towards an increasing trend after 37,000 AD for *drained-mire farmers*. As the high inventory does not influence the modelled impact of processes the descriptions and corresponding explanations given in Section 9.2.1 for the *global warming variant of the main scenario* are also valid for the *high inventory scenario*.

**Table 9-3. Peak annual effective dose to a representative individual of the most exposed group obtained for the *high inventory scenario*.**

Annual dose [ $\mu$ Sv]	Year [AD]	Contribution from waste vault (%)	Contribution from radionuclide (%)	Exposed group (biosphere object)
17.7	7500	Silo (52.3)	Mo-93 (47.3)	Drained-mire farmer (Object 157_2)
		1BMA (13.7)	Se-79 (15.1)	
		1BLA (11.2)	C-14-org (8.4)	
		2BMA (9.0)	I-129 (7.7)	
		2BTF (2.9)	U-238 (5.8)	
		1BTF (2.5)	Cl-36 (4.6)	
		5BLA (1.8)	Ca-41 (3.7)	
		2BLA (1.7)	U-235 (2.9)	
		4BLA (1.7)	Ni-59 (1.5)	
		3BLA (1.6)	Pa-231 (1.1)	
		BRT (1.5)	Others (2.0)	



**Figure 9-10.** Arithmetic mean of the annual effective dose for different exposed groups in biosphere object 157\_2 and maximum annual effective dose for the **high inventory calculation case**. The maximum annual effective dose of the **global warming calculation case** is also shown for comparison. The unshaded areas correspond to temperate climatic conditions and the grey shaded areas to periglacial conditions with continuous permafrost. (H&G – hunters and gatherers, IO – infield–outland farmers, DM – drained-mire farmers, and GP – garden plot household).

The peak dose and its contributions from waste vaults and dominating radionuclides are presented in Table 9-3. As for the *global warming calculation case*, the peak dose occurs in biosphere object 157\_2 and in the group *drained-mire farmers*. There is an increase to the contributions to peak dose from the silo in this scenario (52%) compared with the *global warming calculation case* (45%). However, since the other waste vaults in SFR 1 decrease their relative contribution, the contribution to peak dose from SFR 1 (79%) is similar to that in the *global warming calculation case* (77%).

In this calculation case, Se-79 becomes the second most contributing radionuclide (15%), whereas its contribution to peak dose is below 1% in the *global warming variant of the main scenario*. This is due to the nearly tenfold augmentation of the Se-79 inventory in 2–5BLA vaults and about fiftyfold in the other vaults (Figure 9-11). In the case of Mo-93, the contribution to the peak dose decreases from 60% in the *global warming variant of the main scenario* to 47% in the present case due to relatively low uncertainties in the Mo-93 inventory. Uncertainties in the inventory data are reported in full detail in the inventory report (SKB 2013a) and in SKBdoc 1427105.

Due to the uncertainty of inventories of activation products in the decommissioning waste, the inventory of Ca-41 (which is only emplaced as decommissioning waste in 2BMA) is three times higher in the *high inventory scenario* than in the main scenario (Figure 9-11). The inventory of induced C-14 is calculated in the same way as for Ca-41. However, the uncertainties for the inventory of C-14 is lower than for Ca-41 since the induced C-14 activity is found in systems closer to the reactor core where the accuracy in the model is higher than for systems further away where Ca-41 is generated (concrete). The uncertainty in the inventory of induced C-14 is deemed to be higher than for the C-14 originating from the water clean-up systems.

The main contribution to the peak dose for the *drained-mire farmers* exposed group comes from the four waste vaults silo, 1BMA, 1BLA, and 2BMA which together contribute about 86% to the peak dose. 1BTF and 2BTF account for another 5% and other waste vaults accounts for less than 2% each of the peak dose. Differences between waste vault contributions are mainly due to different waste vault inventories. The relative contributions to annual dose for *drained-mire farmers* in the *high inventory calculation case* are similar to those obtained for the *global warming calculation case*, with differences discussed below.

## Annual doses to drained-mire farmers in biosphere object 157\_2

Time series of doses to *drained-mire farmers* in biosphere object 157\_2 from waste vault specific releases are presented for the four most contributing waste vaults in Figures 9-12 to 9-15. During periods of the periglacial domain *drained-mire farming* is not possible and exposure for drained-mire farmers is not assessed for periglacial periods.

For the silo, Mo-93, Se-79, C-14-org, I-129 and Cl-36 are the most contributing radionuclides to the peak dose that occurs at 7950 AD (Figure 9-12). Ni-59 is the dominating radionuclide after 40,000 AD. The high relevance of Se-79, contributing more than 15% to the peak dose until 40,000 AD, due to its higher relative increase in inventory (see Figure 9-11) is the most prominent difference with respect to the *global warming calculation case*.

For 1BMA, the highest contributions to dose in the early part of the assessment period originate from the same radionuclides as for the silo, Mo-93, Se-79, C-14-org, I-129 and Cl-36 (Figure 9-13). From 16,500 AD, Ni-59 becomes the most important radionuclide for the dose from 1BMA. The build-up of dose due to Ni-59 lasts until the end of the second period of the temperate domain. The peak dose of 5  $\mu\text{Sv}$  for the release from the 1BMA vault is reached at 66,500 AD, and is dominated by Ni-59 (66%), Zr-93 (11%) and Cs-135 (9%).

For 1BLA, Mo-93 dominates the dose initially, but after year 5100 AD U-238 becomes the dominating radionuclide (Figure 9-14). The peak dose occurs 7750 AD and the main contribution to the peak dose are caused by U-238 and U-235 followed by Mo-93 and Pa-231. Progeny of U-235, i.e. Pa-231 and Ac-227, become increasingly more important over time.

For 2BMA, Mo-93 contributes most to the dose until 14,000 AD (Figure 9-15). Thereafter, Ca-41 is the most contributing radionuclide until the end of the second period of the temperate domain when Ni-59 becomes the most contributing radionuclide until the end of the assessment period. The peak dose in biosphere object 157\_2 due to releases from 2BMA occurs at 13,500 AD, with comparable contributions from Mo-93 and Ca-41 and one order of magnitude less from Cl-36.

As in the *global warming calculation case*, Mo-93 is the only radionuclide that contributes from all waste vaults substantially to dose at the peak time of the entire release at 7500 AD. For the waste vaults that contributes most to dose (at 7500 AD), the contribution from Mo-93 to the peak dose of each of the waste vaults is as follows: Silo (41%), 1BMA (31%), 1BLA (12%), and 2BMA (67%).

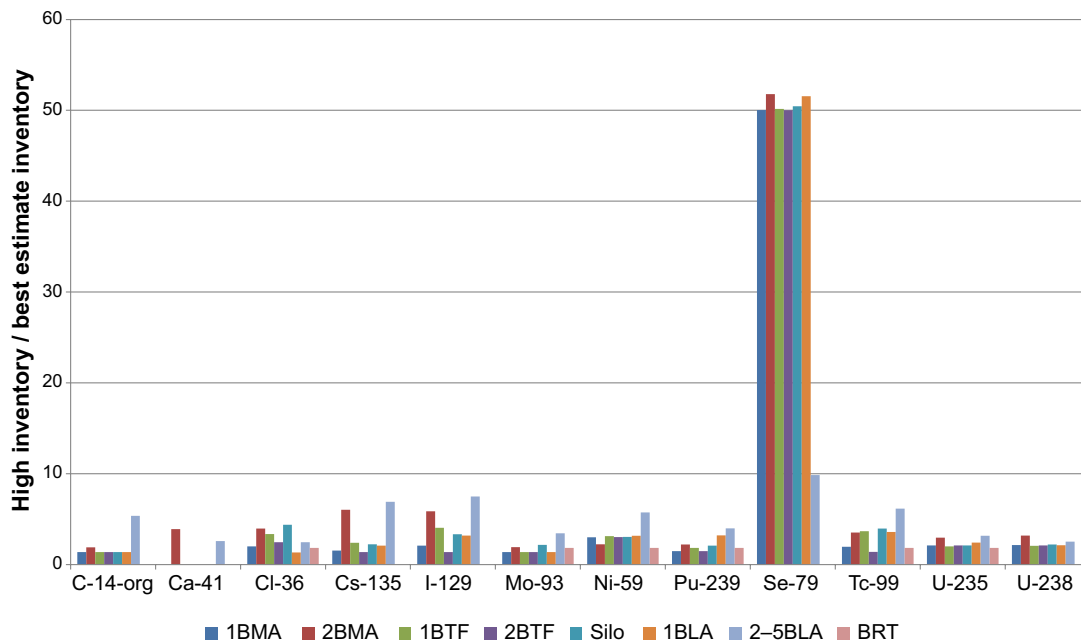
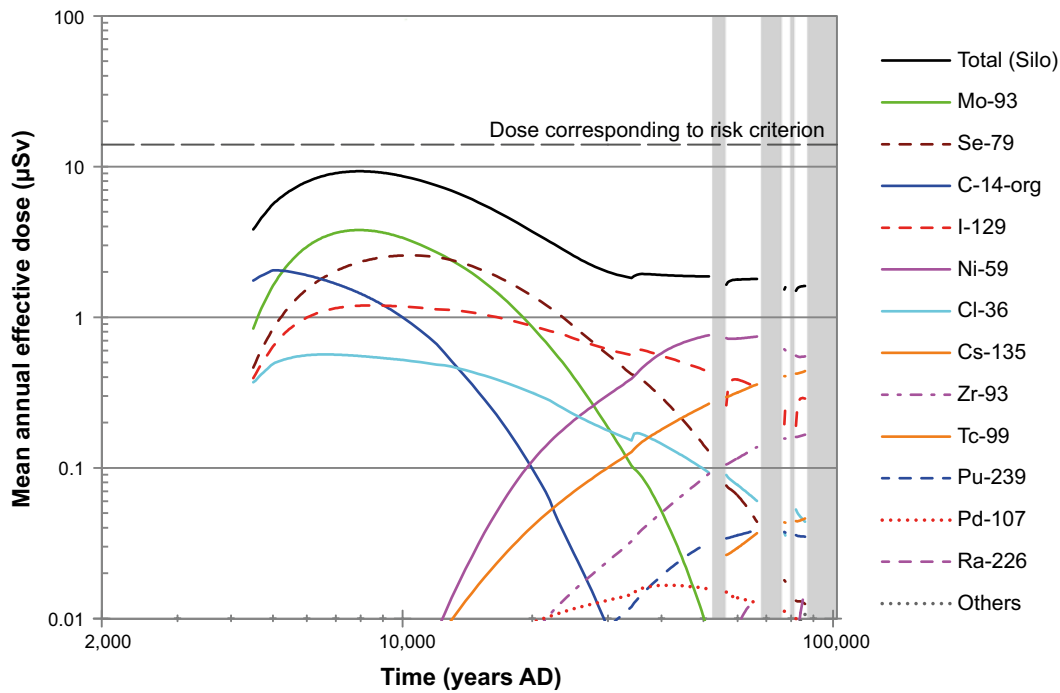
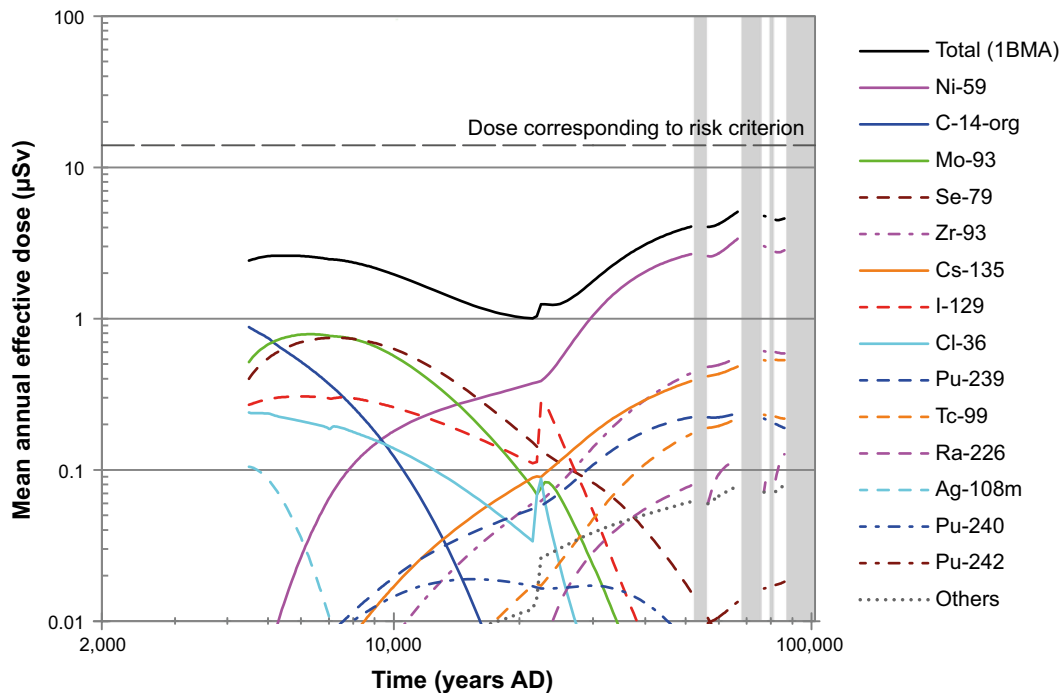


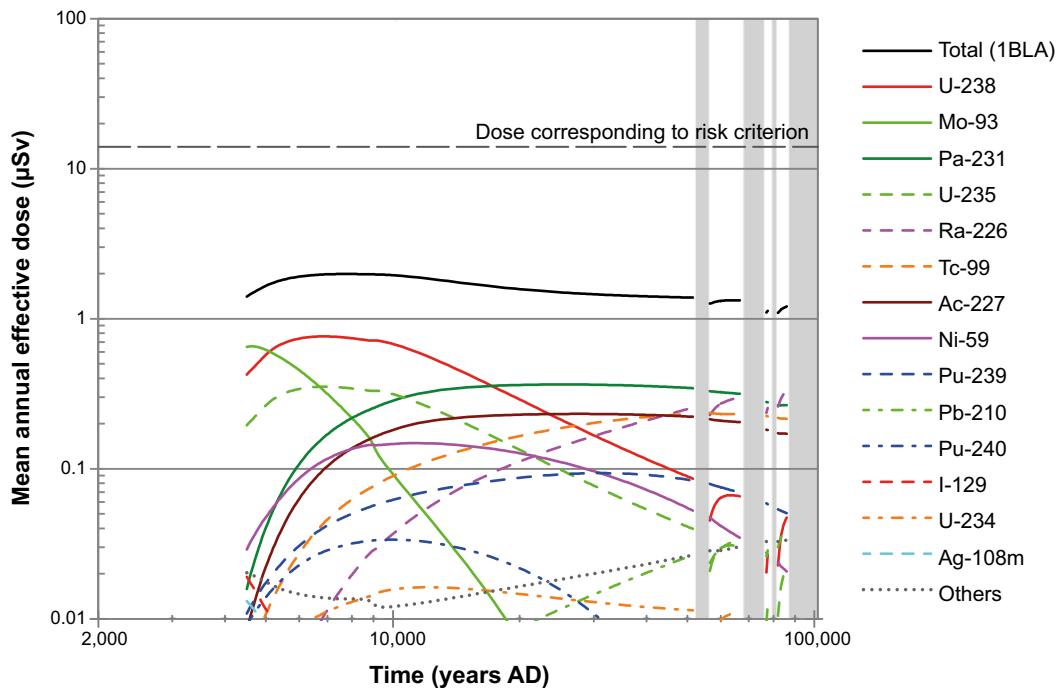
Figure 9-11. Ratio of the high inventory to the best estimate inventory.



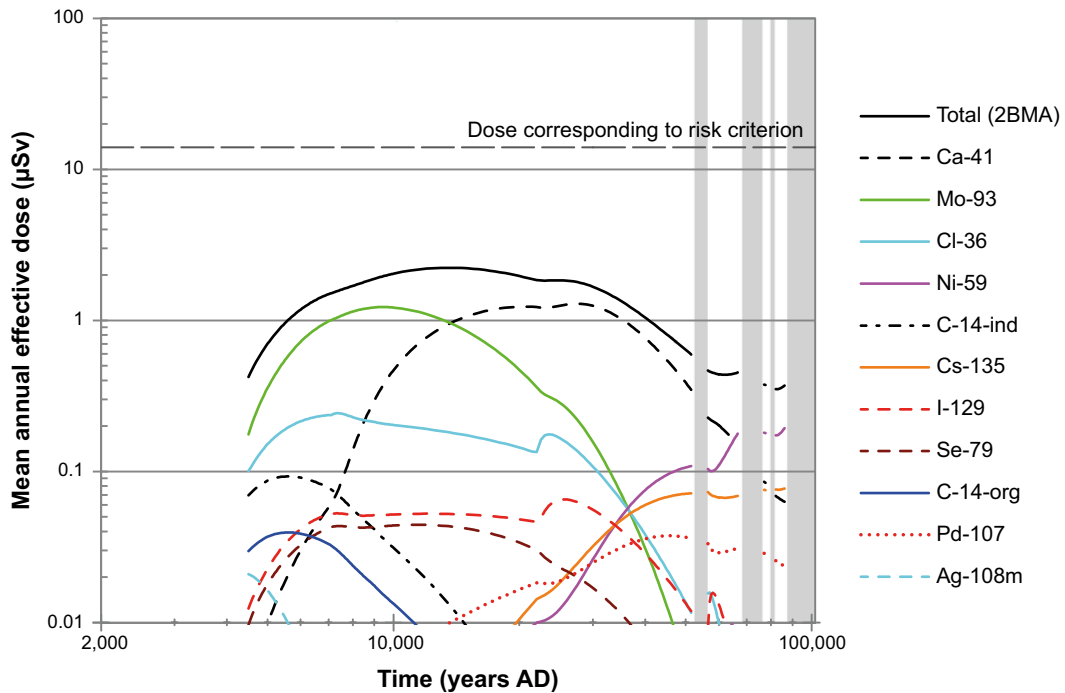
**Figure 9-12.** Arithmetic mean of the annual dose to the *drained-mire farmers* exposed group in biosphere object 157\_2. Values are shown for doses from releases from the *silos* in the *high inventory calculation case*. The unshaded areas correspond to temperate climatic conditions and the grey shaded areas to periglacial conditions with continuous permafrost.



**Figure 9-13.** Arithmetic mean of the annual dose to the *drained-mire farmers* exposed group in biosphere object 157\_2. Values are shown for doses from releases from *1BMA* in the *high inventory calculation case*. The unshaded areas correspond to temperate climatic conditions and the grey shaded areas to periglacial conditions with continuous permafrost.



**Figure 9-14.** Arithmetic mean of the annual dose to the *drained-mire farmers* exposed group in biosphere object 157\_2. Values are shown for doses from releases from **1BLA** in the **high inventory calculation case**. The unshaded areas correspond to temperate climatic conditions and the grey shaded areas to periglacial conditions with continuous permafrost.



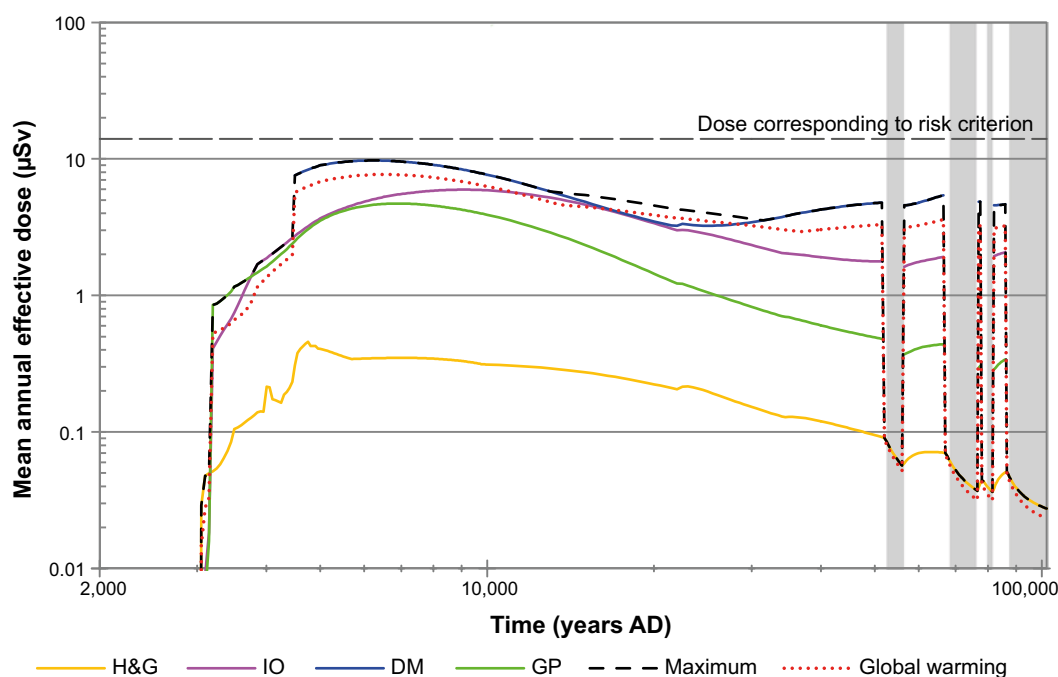
**Figure 9-15.** Arithmetic mean of the annual dose to the *drained-mire farmers* exposed group in biosphere object 157\_2. Values are shown for doses from releases from **2BMA** in the **high inventory calculation case**. The unshaded areas correspond to temperate climatic conditions and the grey shaded areas to periglacial conditions with continuous permafrost.

### 9.3.2 High flow in the bedrock scenario

The *high flow in the bedrock scenario* is described in Section 7.6.2. In this scenario, water flow in waste vaults are higher than in the *global warming variant of the main scenario* due to an increased flow in the bedrock.

Time series of annual effective doses to the exposed groups in biosphere object 157\_2 and the maximum dose for the *high flow in the bedrock calculation case* are presented in Figure 9-16. The peak dose occurs at 6250 AD, which is 250 years earlier than in the *global warming calculation case* (see Tables 9-1 and 9-4). This is consistent with higher flows in the vault grout leading to higher release rates from the near-field. After the peak dose, the maximum dose decreases moderately during periods of the temperate domain until 30,000 AD when the same transition towards an increasing trend is observed as in the main scenario. Hence, after the peak dose, there is only a moderate temporal variation in the maximum dose, with the exception of the periglacial periods. The peak dose is slightly higher in the *high flow in the bedrock calculation case* than in the *global warming calculation case* (9.7  $\mu\text{Sv}$  compared with 7.7  $\mu\text{Sv}$ , see Table 9-4 and Table 9-1), but the most contributing radio-nuclides are the same in both cases.

The main contributions to peak dose come from the silo, 1BMA, 1BLA, and 2BMA, which together contribute 82% of the peak dose. The relative contributions from the waste vaults are similar to those in the *global warming calculation case*. The evolution of annual dose, including maximum dose, is very similar to that in the *global warming calculation case*, though the peak dose occurs 250 years earlier and the maximum dose is about 2  $\mu\text{Sv}$  higher in this case (see Figure 9-16) due to the augmented flows.



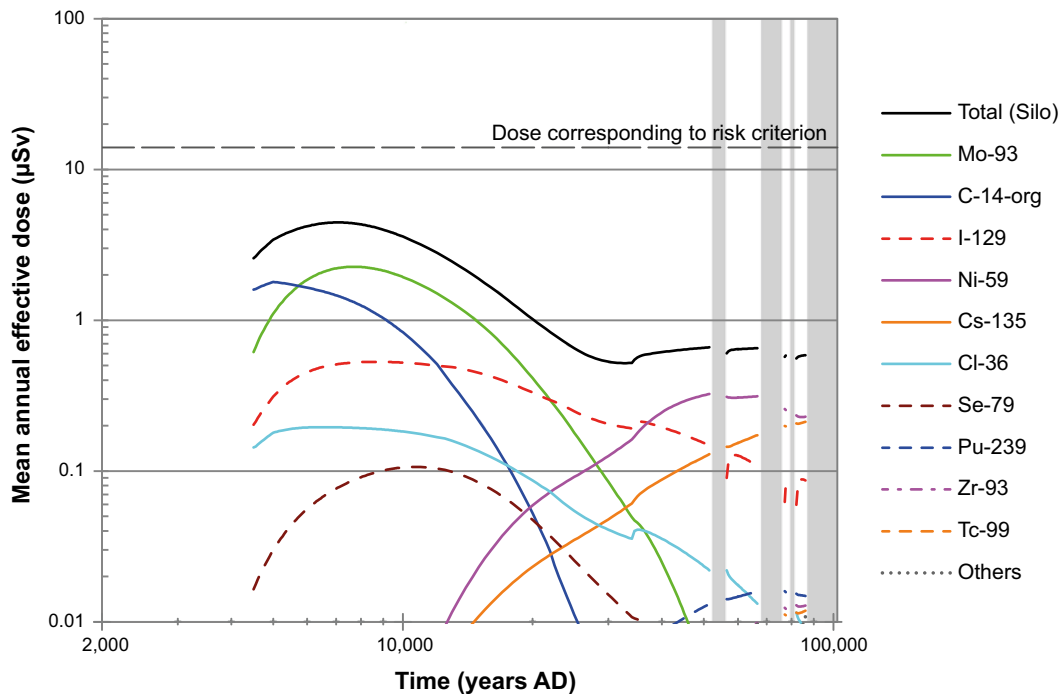
**Figure 9-16.** Arithmetic mean of annual dose for exposed groups in biosphere object 157\_2 and the maximum for all biosphere objects in the *high flow in the bedrock calculation case*. Maximum dose for the *global warming calculation case* is also shown for comparison. H&G – hunters and gatherers, IO – infield-out-land farmers, DM – drained-mire farmers, and GP – garden plot household. The unshaded areas correspond to temperate climatic conditions and the grey shaded areas to periglacial conditions with continuous permafrost.

**Table 9-4. Peak annual effective dose to a representative individual from the most exposed group obtained for the *high flow in the bedrock scenario*.**

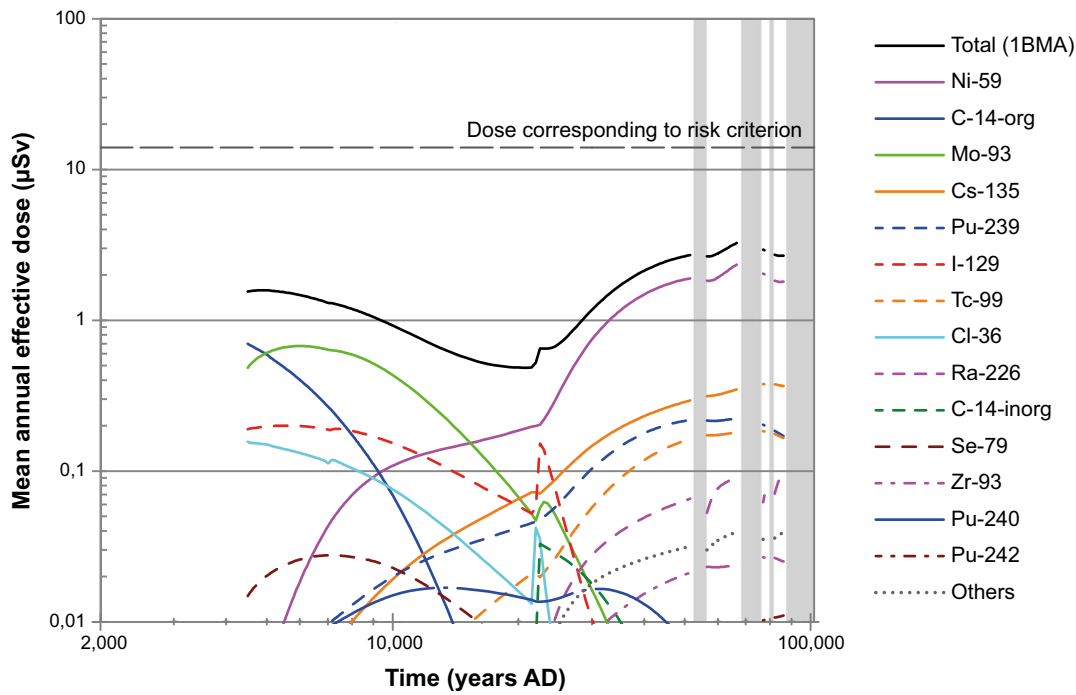
Annual dose [ $\mu$ Sv]	Year [AD]	Contribution from waste vault (%)	Contribution from radionuclide (%)	Exposed group (biosphere object)
9.7	6250	Silo (44.3)	Mo-93 (58.1)	Drained-mire farmers
		1BMA (14.7)	C-14-org (17.4)	(Object 157_2)
		1BLA (11.8)	U-238 (6.6)	
		2BMA (11.6)	I-129 (5.4)	
		2BTF (4.7)	Cl-36 (3.1)	
		BRT (3.9)	U-235 (2.9)	
		1BTF (3.8)	Ca-41 (2.7)	
		4BLA (1.4)	Others (3.8)	
		5BLA (1.3)		
		2BLA (1.2)		
		3BLA (1.3)		

**Annual doses to drained-mire farmers in biosphere object 157\_2**

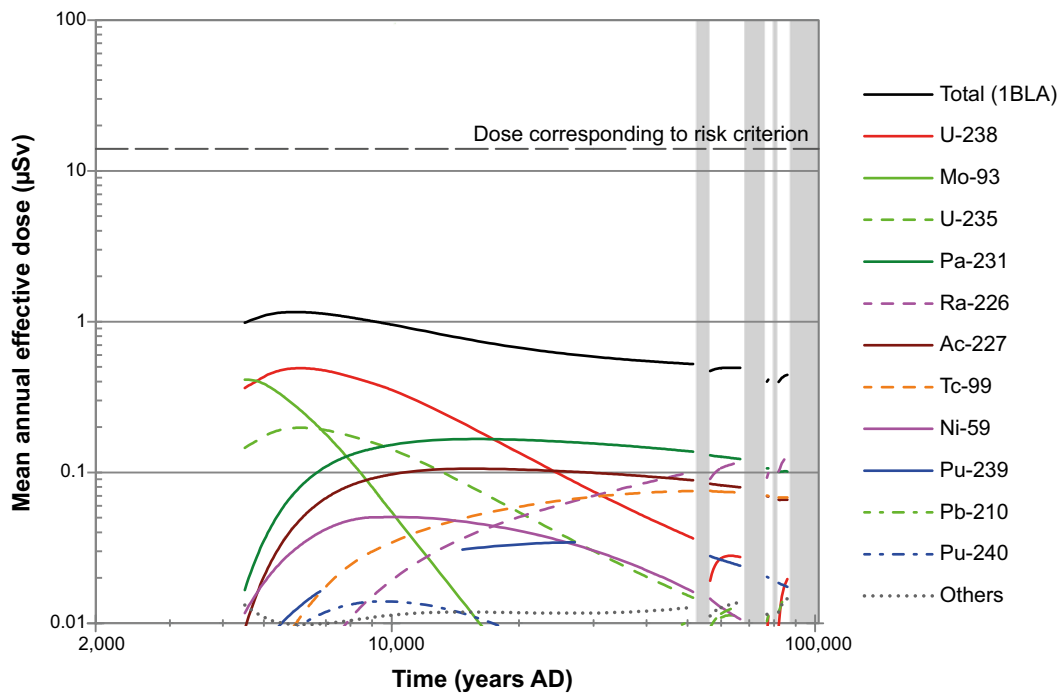
Figures 9-17 to 9-20 show time series of annual effective dose and contributions of dominating radionuclides for *drained-mire farmers* in biosphere object 157\_2, due to waste vault specific releases. The radionuclides contributing most to the peak doses from these waste vaults are the same as in the *global warming calculation case*, i.e. the discussion in Section 9.2.1 on the Figures 9-3 to 9-6 is valid also for this scenario. Comparing the results in Figures 9-17 to 9-20 with the results for the *global warming calculation case* (Figure 9-3 to 9-6) shows no significant differences in the two cases and that the estimated dose is rather insensitive to the increased water flows, at least for the waste vaults with hydraulic barriers.



**Figure 9-17. Arithmetic mean of the annual dose to the *drained-mire farmers* exposed group in biosphere object 157\_2. Values are shown for doses from releases from the *silos* in the *high flow in the bedrock calculation case*. The unshaded areas correspond to temperate climatic conditions and the grey shaded areas to periglacial conditions with continuous permafrost.**

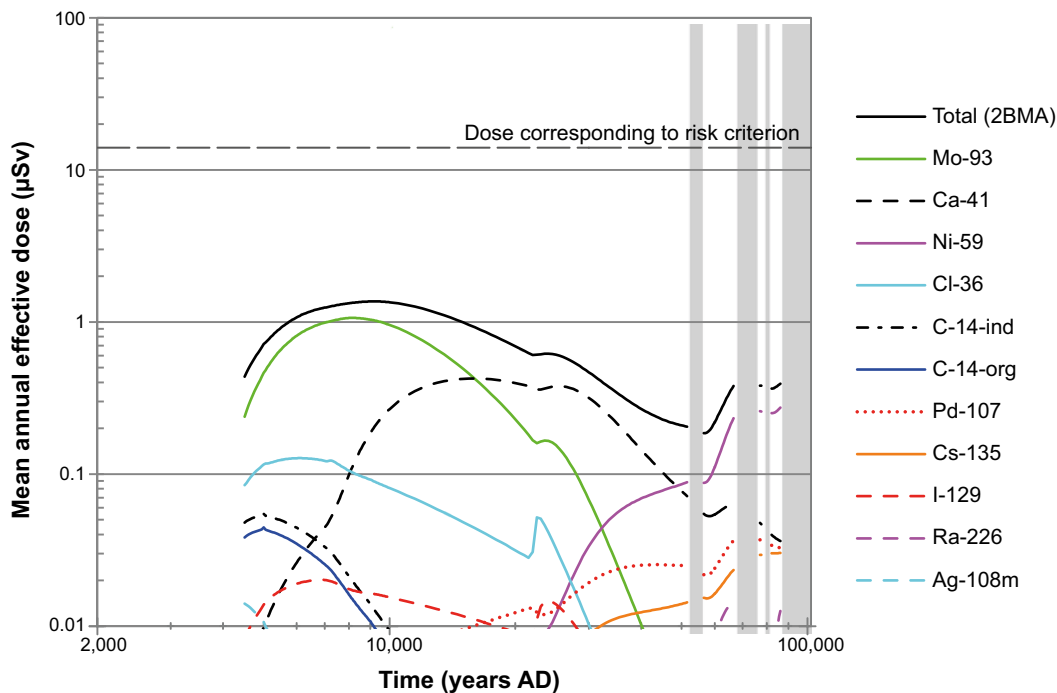


**Figure 9-18.** Arithmetic mean of the annual dose to the *drained-mire farmers* exposed group in biosphere object 157\_2. Values are shown for doses from releases from **1BMA** in the **high flow in the bedrock calculation case**. The unshaded areas correspond to temperate climatic conditions and the grey shaded areas to periglacial conditions with continuous permafrost.



**Figure 9-19.** Arithmetic mean of the annual dose to the *drained-mire farmers* exposed group in biosphere object 157\_2. Values are shown for doses from releases from **1BLA** in the **high flow in the bedrock calculation case**. The unshaded areas correspond to temperate climatic conditions and the grey shaded areas to periglacial conditions with continuous permafrost.





**Figure 9-20.** Arithmetic mean of the annual dose to the *drained-mire farmers* exposed group in biosphere object 157\_2. Values are shown for doses from releases from 2BMA in the *high flow in the bedrock calculation case*. The unshaded areas correspond to temperate climatic conditions and the grey shaded areas to periglacial conditions with continuous permafrost.

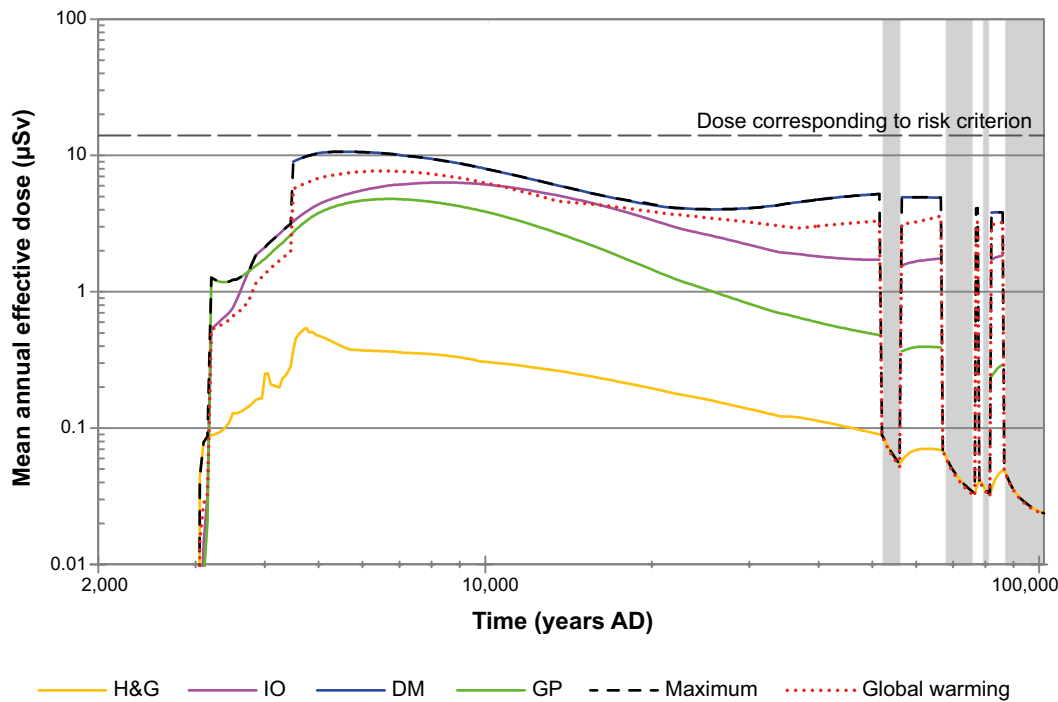
### 9.3.3 Accelerated concrete degradation scenario

The *accelerated concrete degradation scenario* is described in Section 7.6.3. In this scenario, the hydraulic conductivity of the concrete increases considerably earlier or to a greater extent than in the *global warming variant of the main scenario*.

Time series of annual effective doses to the exposed groups in biosphere object 157\_2 and the maximum effective annual dose for the corresponding calculation case are presented in Figure 9-21. The peak dose occurs earlier than in the *global warming calculation case* (by 950 years) and also earlier than in the *high flow in the bedrock scenario* (by 450 years) due to faster advective transport because of higher conductivity of the concrete barriers. The peak dose increases compared with the *global warming calculation case*. Apart from these shifts, the evolution of annual effective dose in this scenario follows the same pattern as in the *global warming variant of the main scenario*, compare Figure 9-21 and Figure 9-1. After the peak dose at 5550 AD, there is only a weak variation of the maximum dose during the whole simulation period, except for periods of the periglacial domain.

The peak dose for the *accelerated concrete degradation scenario* is 10.6 µSv (Table 9-5), which is an increase by about 40% compared with the *global warming calculation case* (Table 9-1). The radionuclides that dominate the peak dose in this scenario are almost the same as in the *global warming variant of the main scenario*.

The main contribution to the peak dose for the *drained-mire farmers* exposed group in the *accelerated concrete degradation scenario* come from 1BMA, silo, 2BMA, and 1BLA, which together contribute 84% of the peak dose. The order of the contributions from vaults is different from the *global warming variant of the main scenario*, with 1BLA and silo having a lower relative contribution in this scenario. This is explained by enhanced releases from 1BMA and 2BMA, which have concrete barriers being affected by the degradation. The reason that the doses from the silo are not affected by the accelerated concrete degradation is that the bentonite barrier is assumed to remain intact. The doses from 1BLA are identical to the *global warming calculation case*, due to the lack of concrete barriers in the waste vault.



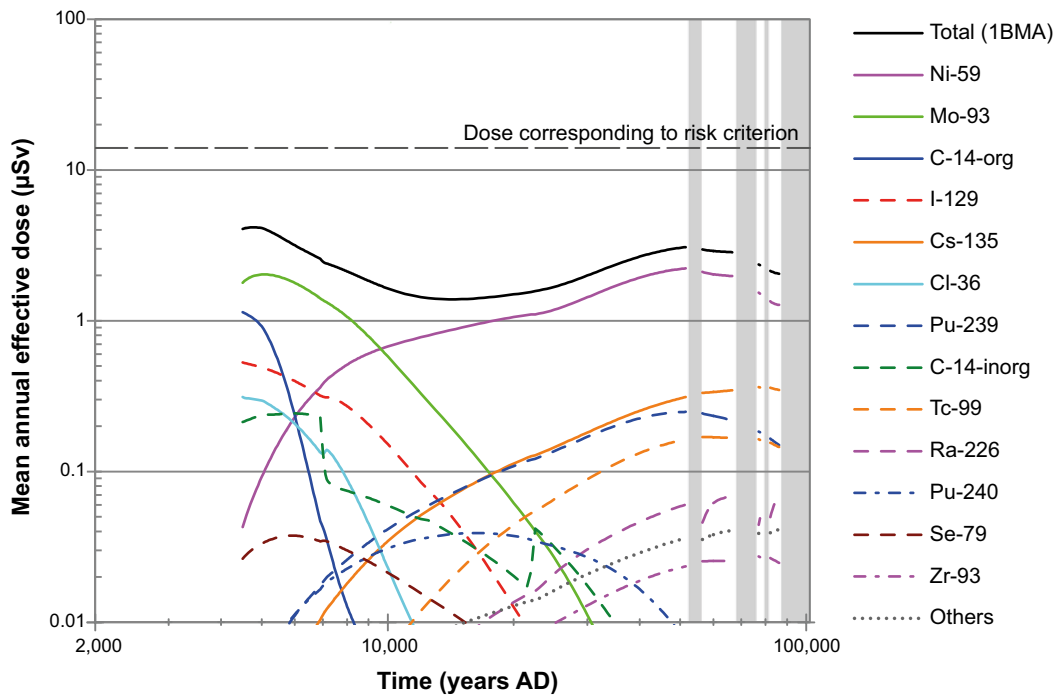
**Figure 9-21.** Arithmetic mean of annual dose for exposed groups in biosphere object 157\_2 and the maximum for all biosphere objects in the *accelerated concrete degradation calculation case*. Maximum dose for the *global warming calculation case* is also shown for comparison. H&G – hunters and gatherers, IO – infield–outland farmers, DM – drained-mire farmers, and GP – garden plot household. The unshaded areas correspond to temperate climatic conditions and the grey shaded areas to periglacial conditions with continuous permafrost.

**Table 9-5. Peak annual effective dose to a representative individual of the most exposed group obtained for the *accelerated concrete degradation scenario*.**

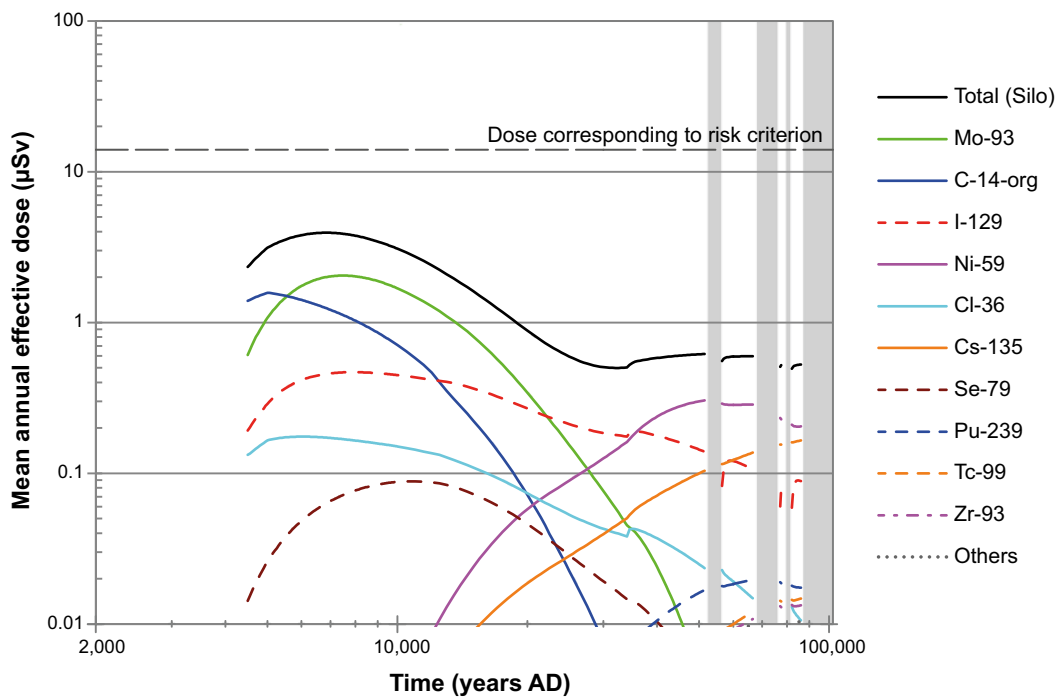
Annual dose [µSv]	Year [AD]	Contribution from waste vault (%)	Contribution from radionuclide (%)	Exposed group (biosphere object)
10.6	5550	1BMA (33.6)	Mo-93 (59.8)	Drained-mire farmer (Object 157_2)
		Silo (33.6)	C-14-org (17.0)	
		2BMA (8.8)	I-129 (6.4)	
		1BLA (8.4)	U-238 (4.3)	
		2BTF (4.8)	Cl-36 (4.0)	
		1BTF (3.8)	C-14-inorg (2.3)	
		BRT (3.5)	U-235 (1.8)	
		2BLA (1.0)	Ca-41 (1.6)	
		3BLA (1.0)	Ni-59 (1.3)	
		5BLA (0.9)	Others (1.5)	
		4BLA (0.8)		

**Annual doses to drained-mire farmers in biosphere object 157\_2**

Figures 9-22 to 9-25 show time series of annual effective dose and contributions of dominating radionuclides for *drained-mire farmers* in biosphere object 157\_2, due to waste vault specific releases from the most contributing waste vaults in the *accelerated concrete degradation calculation case*: 1BMA, silo, 2BMA, and 1BLA. In this scenario, patterns of evolution of annual dose and contributions of waste vaults and radionuclides are again similar to the cases of the *global warming variant of the main scenario*.



**Figure 9-22.** Arithmetic mean of the annual dose to the *drained-mire farmers* exposed group in biosphere object 157\_2. Values are shown for doses from releases from **1BMA** in the **accelerated concrete degradation calculation case**. The unshaded areas correspond to temperate climatic conditions and the grey shaded areas to periglacial conditions with continuous permafrost.



**Figure 9-23.** Arithmetic mean of the annual dose to the *drained-mire farmers* exposed group in biosphere object 157\_2. Values are shown for doses from releases from the **silo** in the **accelerated concrete degradation calculation case**. The unshaded areas correspond to temperate climatic conditions and the grey shaded areas to periglacial conditions with continuous permafrost.

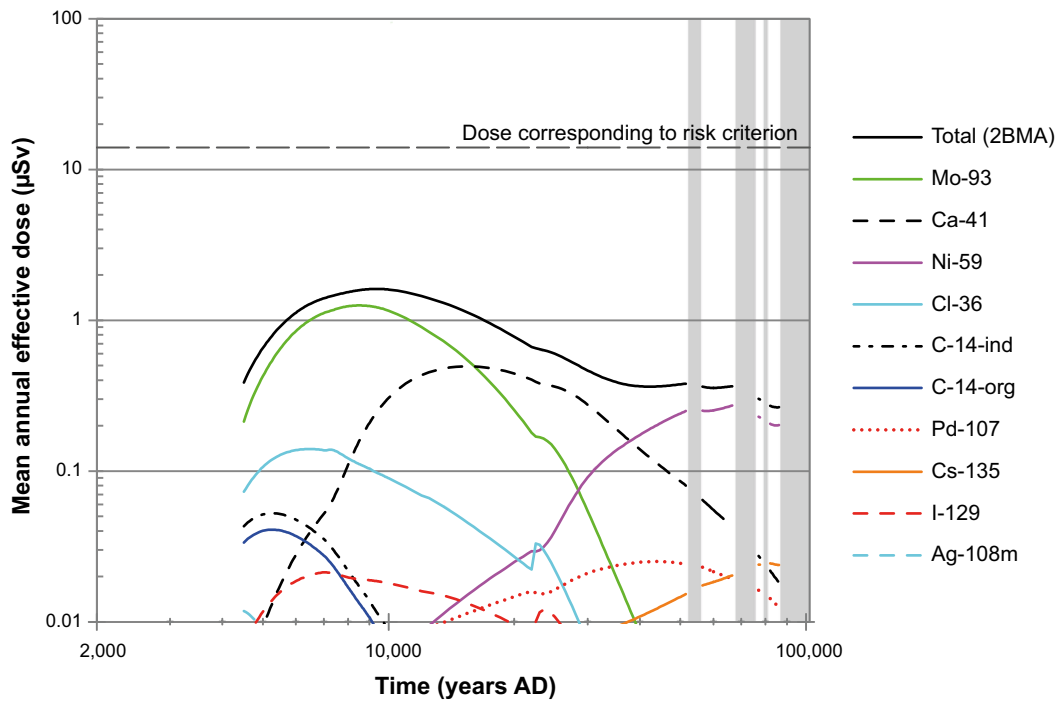


Figure 9-24. Arithmetic mean of the annual dose to the **drained-mire farmers** exposed group in biosphere object 157\_2. Values are shown for doses from releases from **2BMA** in the **accelerated concrete degradation calculation case**. The unshaded areas correspond to temperate climatic conditions and the grey shaded areas to periglacial conditions with continuous permafrost.

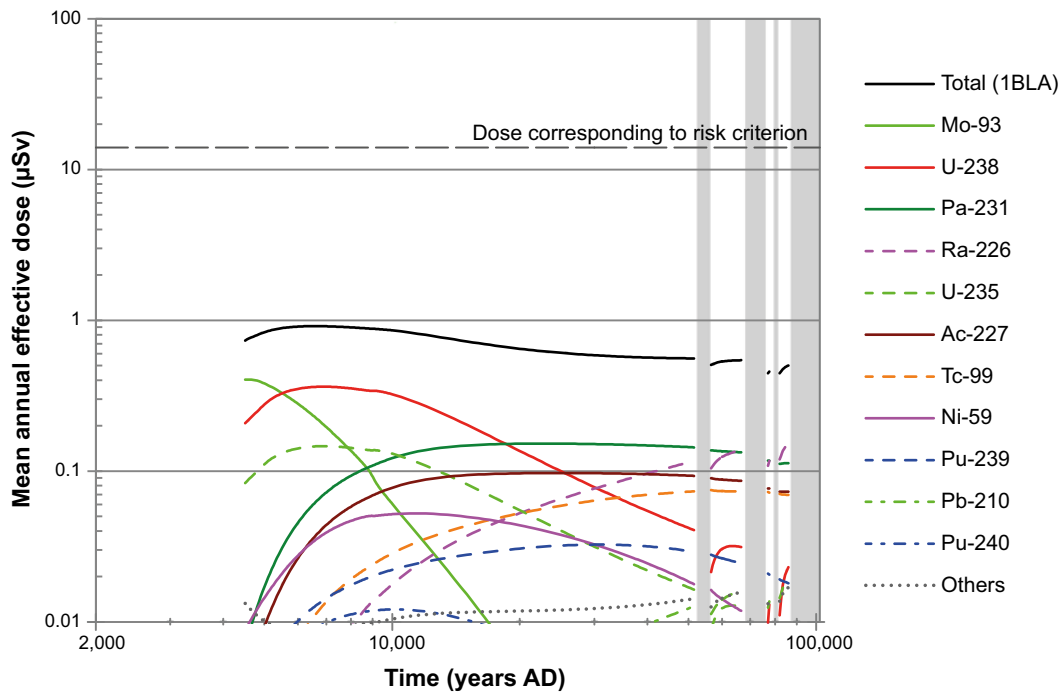


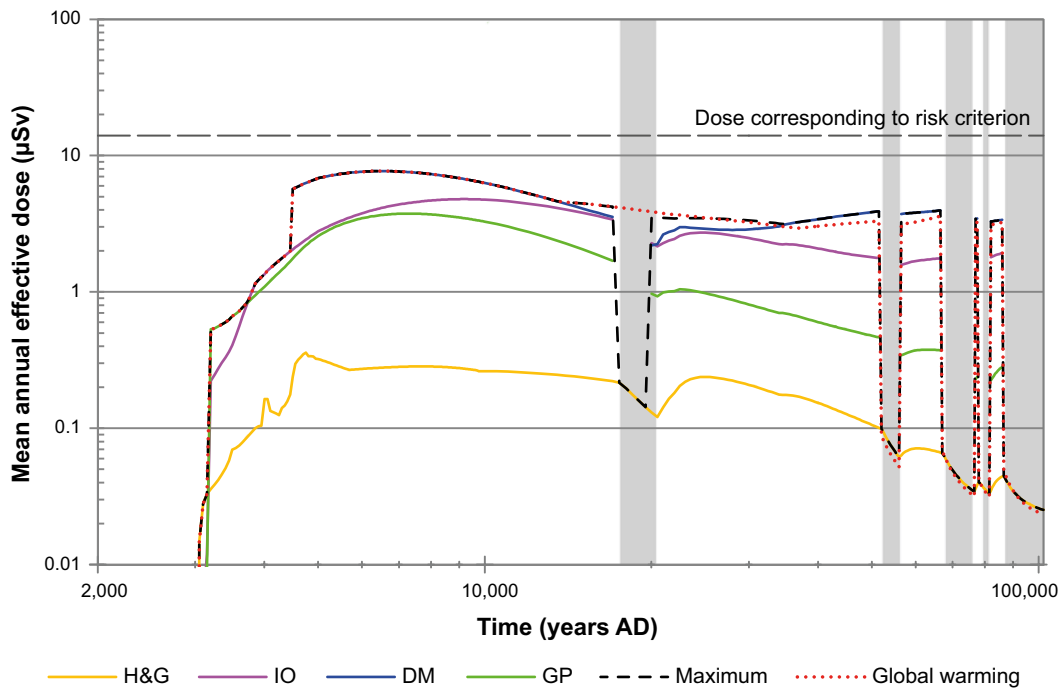
Figure 9-25. Arithmetic mean of the annual dose to the **drained-mire farmers** exposed group in biosphere object 157\_2. Values are shown for doses from releases from **1BLA** in the **accelerated concrete degradation calculation case**. The unshaded areas correspond to temperate climatic conditions and the grey shaded areas to periglacial conditions with continuous permafrost.

### 9.3.4 Bentonite degradation scenario

The *bentonite degradation scenario* is described in Section 7.6.4. In this scenario, the bentonite as part of the technical barrier system of the silo degrades due to the formation of an ice-lens during an early periglacial period prevailing from 17,500 AD to 20,500 AD with the consequence of increased water flows in this part of the repository.

Time series of annual effective doses to the exposed groups in biosphere object 157\_2 and the maximum effective annual dose for the *bentonite degradation calculation case* are presented in Figure 9-26.

The peak dose of 7.7  $\mu\text{Sv}$  occurs at year 6500 AD, i.e. the same as in the *global warming calculation case* (Table 9-6 and Table 9-1). During the initial period of the temperate domain until year 17,500 AD, internal and external conditions are the same as in the *global warming calculation case*.



**Figure 9-26.** Arithmetic mean of annual dose for exposed groups in biosphere object 157\_2 and the maximum for all biosphere objects in the *bentonite degradation calculation case*. Maximum dose for the *global warming calculation case* is also shown for comparison. H&G – hunters and gatherers, IO – infield–outland farmers, DM – drained-mire farmers, and GP – garden plot household. The unshaded areas correspond to temperate climatic conditions and the grey shaded areas to periglacial conditions with continuous permafrost, except for the taliks assumed to exist between 17,500 and 20,500 AD.

**Table 9-6. Peak annual effective dose to a representative individual of the most exposed group obtained for the *bentonite degradation scenario*.**

Annual dose [ $\mu\text{Sv}$ ]	Year [AD]	Contribution from waste vault (%)	Contribution from radionuclide (%)	Exposed group (biosphere object)
7.7	6500	Silo (45.3)	Mo-93 (57.7)	Drained-mire farmer (Object 157_2)
		1BMA (15.8)	C-14-org (17.9)	
		1BLA (11.9)	U-238 (6.4)	
		2BMA (8.4)	I-129 (5.8)	
		2BTF (5.0)	Cl-36 (3.3)	
		BRT (4.2)	Ca-41 (2.8)	
		1BTF (4.1)	U-235 (2.7)	
		5BLA (1.4)	Others (3.4)	
		2BLA (1.4)		
		4BLA (1.3)		
		3BLA (1.3)		

Annual doses are lower during periglacial periods, including the early periglacial period, for the same reasons as given in Section 9.2. After the early periglacial period, the maximum dose increases to the same level as before the start of the permafrost, and increases only moderately thereafter, and do not surpass the peak dose at year 6500 AD. Thus, the formation of an ice-lens during an early period of permafrost does not affect the peak dose in this calculation case, although the degraded state of the bentonite barriers remains after thawing.

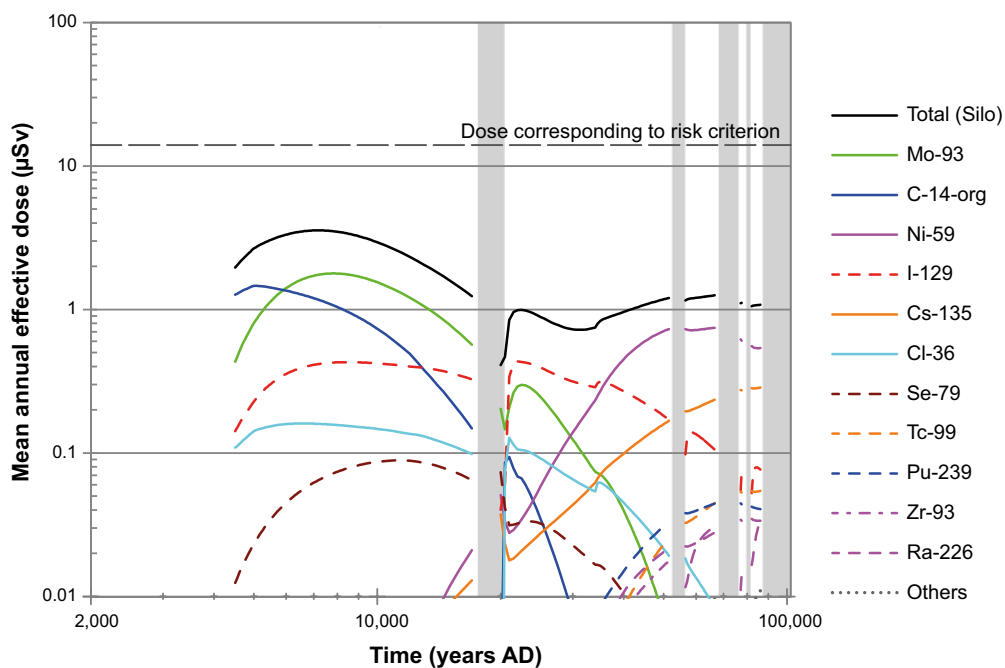
### Annual doses to drained-mire farmers in biosphere object 157\_2

Figure 9-27 presents the contributions of radionuclides from the silo, the only waste vault whose barriers are affected by the ice-lens. Comparing this figure with Figure 9-3 which presents the corresponding results for the *global warming calculation case*, shows that, in the long-term, the total contribution from the silo exceeds the contribution in the *global warming calculation case* by less than half an order of magnitude. The dose stays well below the peak value occurring in the initial temperate period with identical conditions in both cases.

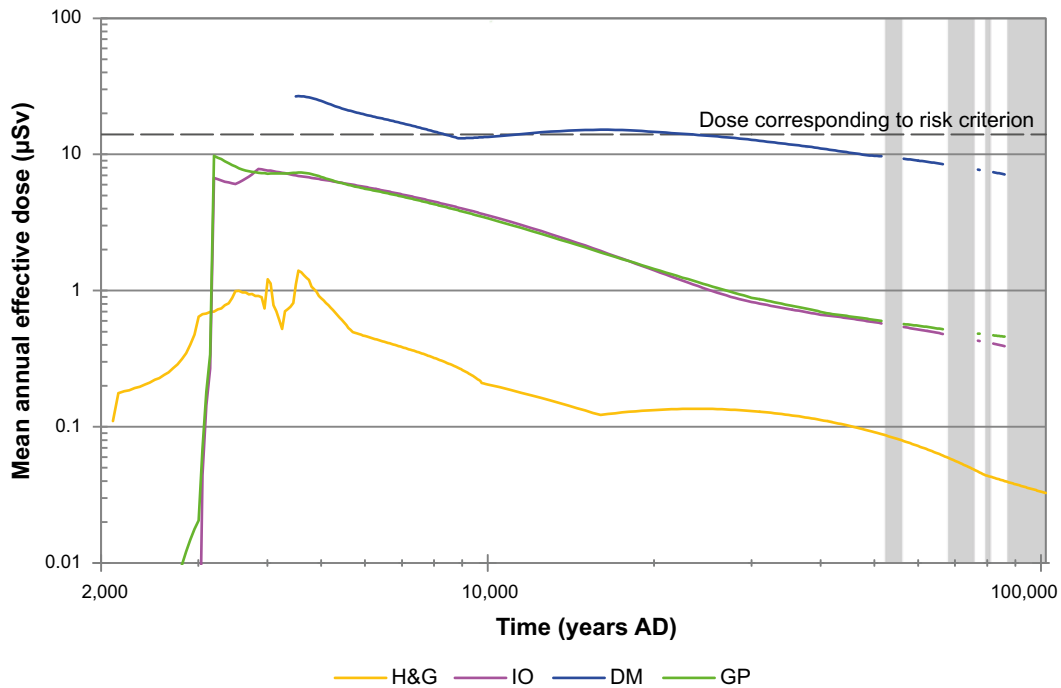
### 9.3.5 Earthquake scenario

The *earthquake scenario*, in which the effect of increased water flow due to an earthquake damaging the structure of the silo is analysed, is described in Section 7.6.5. For this scenario, parameter values were fixed to their best estimates, and the calculations were repeated assuming an earthquake to happen at a different point in time for each calculation, i.e. every 100 years starting from repository closure until the end of the assessment time frame.

Time series of annual effective doses to the exposed groups are presented in Figure 9-28. For all evaluated earthquake events the highest dose to an exposed group is plotted in the figure for each point in time. As for the main scenarios, *hunters and gatherers* receive the maximum annual dose the first 1,000 years when the area is situated below sea. Thereafter, up to 4500 AD, *infield-outfield farmers* and *garden plot household* receive the maximum annual dose. At 4500 AD the land has emerged high enough above sea level so that draining the mire in biosphere object 157\_2 becomes possible, and *drained-mire farmer* obtain the maximum annual doses for the rest of the analysed period (with exception for periglacial periods when only *hunters and gatherers* are present). The peak dose for this scenario is at year 4550 AD, is due to an earthquake event at year 2100 AD and is about 3 times higher than in the *global warming variant of the main scenario* (Table 9-7).



**Figure 9-27.** Arithmetic mean of the annual dose to the *drained-mire farmers* exposed group in object 157\_2. Values are shown for doses from releases from the *silo* in the *bentonite degradation calculation case* of the main scenario. The unshaded areas correspond to temperate climatic conditions and the grey shaded areas to periglacial conditions with continuous permafrost, except for the taliks assumed to exist between 17,500 and 20,500 AD.



**Figure 9-28.** Annual dose for exposed groups in biosphere object 157\_2 in the *earthquake calculation case*. H&G – hunters and gatherers, IO – infield–outland farmers, DM – drained-mire farmers, and GP – garden plot household. The unshaded areas correspond to temperate climatic conditions and the grey shaded areas to periglacial conditions with continuous permafrost.

**Table 9-7. Peak annual effective dose to a representative individual of the most exposed group obtained for the earthquake scenario.**

Annual dose [µSv]	Year (AD)	Earthquake event (AD)	Contribution from radionuclide (%)	Exposed group (biosphere object)
26.7	4550	2100	Mo-93 (71.1) C-14-inorg (9.0) Ni-59 (7.4) I-129 (5.4) C-14-org (2.5) Pu-240 (1.6) Pu-239 (1.4) Others (1.5)	Drained-mire farmer (Object 157_2)

It should be noted that the time point of the peak dose will not coincide with the time point of the peak risk for this scenario. An earthquake at the beginning of the assessment period will always result in the highest dose, as the radionuclide inventory decreases with time due to radioactive decay. The earthquake event has been assigned an annual probability (Section 7.6.5) and the risk is calculated using the cumulative probability that the earthquake event will occur before a given time point. This results in the risk having its maximum much later in the assessment period since the cumulative probability is low at the beginning and increases with time.

### 9.3.6 High concentrations of complexing agents scenario

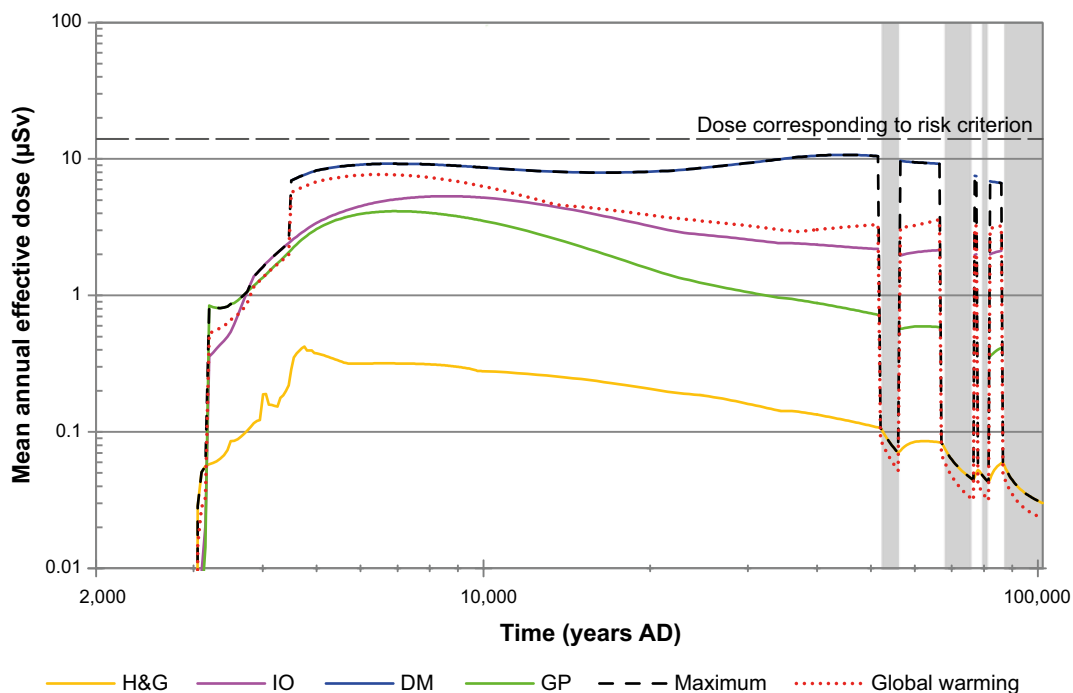
The *high concentrations of complexing agents scenario* is described in Section 7.6.6. In this scenario, higher sorption reduction factors compared with the *global warming variant of the main scenario* were applied to reflect chemical conditions with higher concentrations of complexing agents. Only radionuclides whose sorption properties are potentially affected by organic complexing agents are attributed the reduction factor for the sorption partitioning coefficient in waste vaults containing organic complexing agents.

Time series of annual effective doses to the exposed groups in biosphere object 157\_2 and the maximum effective annual dose for the *high concentrations of complexing agents calculation case* are presented in Figure 9-29.

The peak annual effective dose is presented in Table 9-8, together with the year of occurrence, the contributions from the waste vaults and most relevant radionuclides, as well as the information as to the potentially exposed group for which the peak annual dose occurs and in which of the biosphere objects.

The peak annual effective dose is reached 44,500 AD, which is late in the first period of the temperate domain, and, compared with the previously discussed scenarios, late in time (see Figure 9-29 and Table 9-8). The peak dose is 3  $\mu\text{Sv}$  higher than in the *global warming calculation case* of the main scenario, i.e. 10.7  $\mu\text{Sv}$  versus 7.7  $\mu\text{Sv}$ . This change is due to an increase of a second peak while the first peak remains relatively unchanged in this calculation case. After the peak, the maximum dose shows a moderate decrease until the end of the simulation period during temperate periods. During periglacial periods the level of exposure is significantly lower because of the same conceptual assumptions as in previously discussed scenarios.

The reason for the late peak dose in the *high concentrations of complexing agents scenario* is due to contribution of Ni-59, which is subject to enhanced complexation and is the most important radionuclide in this scenario. This is clearly seen in Figures 9-30 to 9-34 where the time series of the annual effective dose and contributions of dominating radionuclides for *drained-mire farmers* in biosphere object 157\_2 are shown for the five waste vaults that in this scenario are assumed to have higher concentrations of complexing agents than in the main scenario (i.e. the silo, 1-2BMA and 1-2BTF). The radionuclides that dominate the peak dose in the *global warming variant of the main scenario* (Mo-93, C-14-org, U-238, I-129, Cl-36 and U-235) are not subject to enhanced complexation.

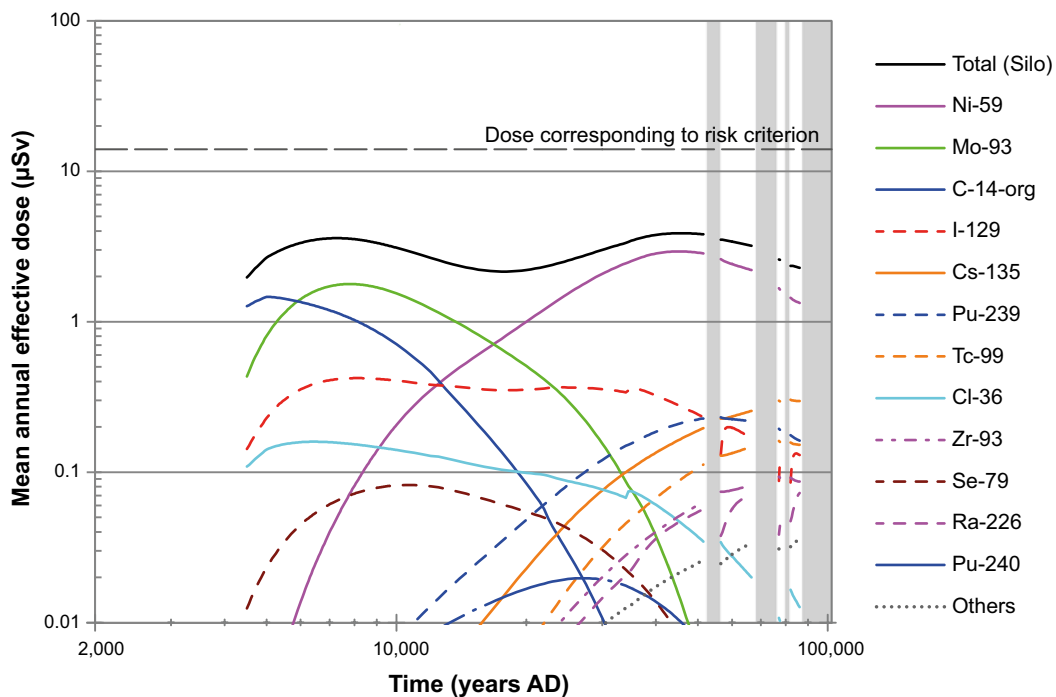


**Figure 9-29.** Arithmetic mean of annual dose for exposed groups in biosphere object 157\_2 and the maximum for all biosphere objects in the *high concentrations of complexing agents calculation case*. Maximum dose for the *global warming calculation case* is also shown for comparison. H&G – hunters and gatherers, IO – infield-outland farmers, DM – drained-mire farmers, and GP – garden plot household. The unshaded areas correspond to temperate climatic conditions and the grey shaded areas to periglacial conditions with continuous permafrost.



**Table 9-8. Peak annual effective dose to a representative individual from the most exposed group obtained for the *high concentrations of complexing agents scenario*.**

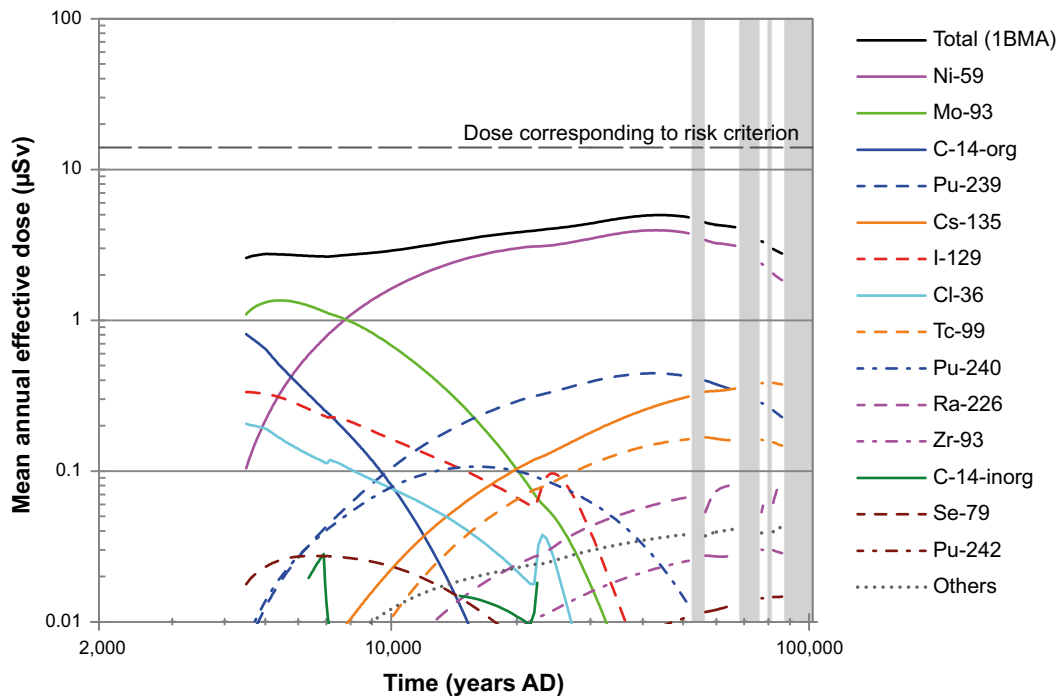
Annual dose [ $\mu$ Sv]	Year [AD]	Contribution from waste vault (%)	Contribution from radionuclide (%)	Exposed group (biosphere object)
10.7	44,500	1BMA (46.5)	Ni-59 (75.7)	Drained-mire farmer
		Silo (36.1)	Pu-239 (8.5)	(Object 157_2)
		2BMA (6.1)	Pa-231 (2.9)	
		1BLA (5.2)	Cs-135 (2.4)	
		2BTF (1.6)	Ca-41 (2.0)	
		BRT (1.0)	Tc-99 (1.7)	
		1BTF (0.9)	Ra-226 (1.5)	
		4BLA (0.8)	Ac-227 (1.5)	
		5BLA (0.8)	I-129 (1.4)	
		2BLA (0.7)	Others (2.5)	
		3BLA (0.6)		



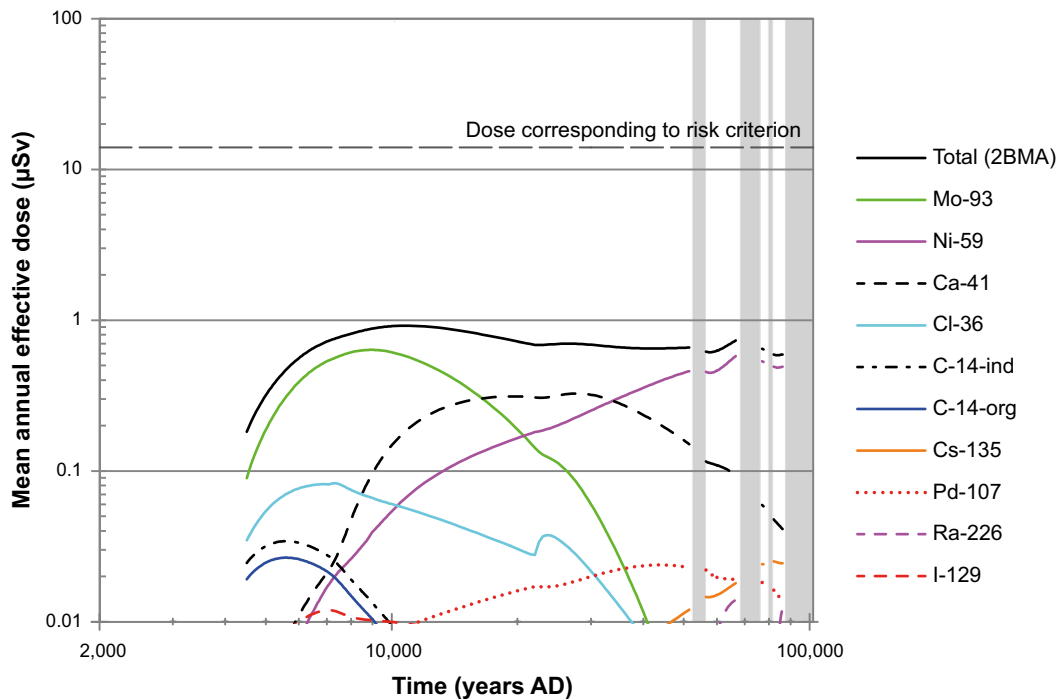
**Figure 9-30.** Arithmetic mean of the annual dose to the *drained-mire farmers* exposed group in biosphere object 157\_2 for releases from the *silos* in the *high concentrations of complexing agents calculation case*. The unshaded areas correspond to temperate climatic conditions and the grey shaded areas to periglacial conditions with continuous permafrost.

Another significant difference compared with the *global warming variant of the main scenario* is that 1BMA is the main contributor to the peak dose in the present calculation case. This is a consequence of radionuclides in 1BMA being the most affected by complexing agents, due to the fact that large quantities of cellulose, that degrades to isosaccharinic acid, are found in this waste vault.

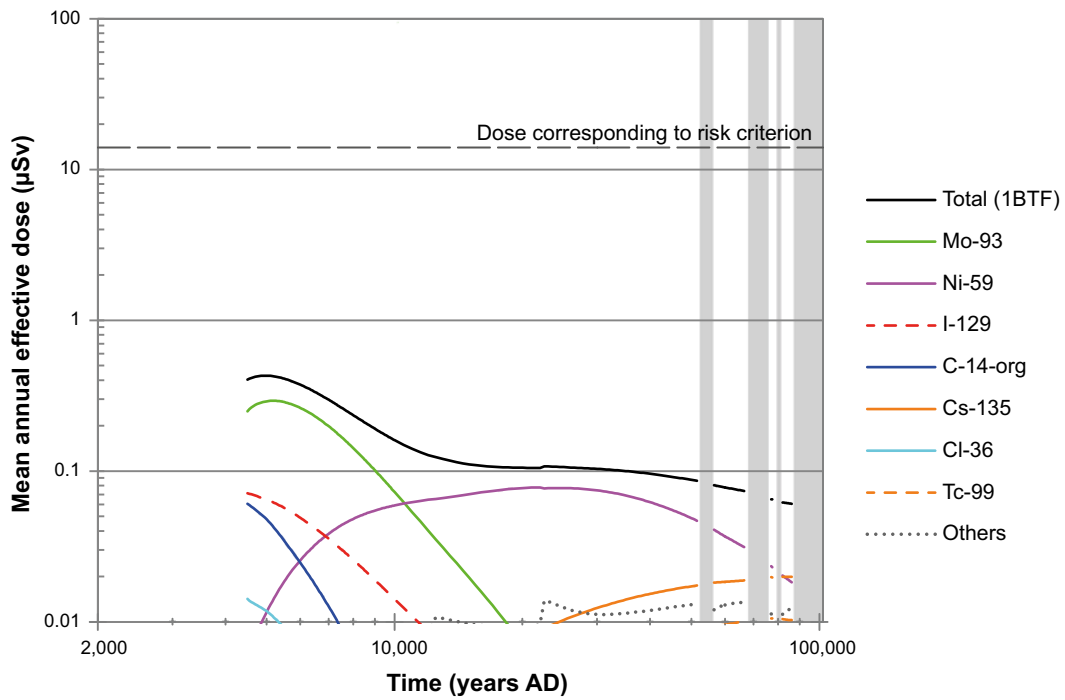
1BMA and the silo together contribute 82.6% to the peak dose. Both waste vaults are assumed to have higher concentrations of complexing agents in this scenario, and these two vaults cause the late peak, as the maximum dose due to releases from the less important waste vaults peaks before 10,000 AD.



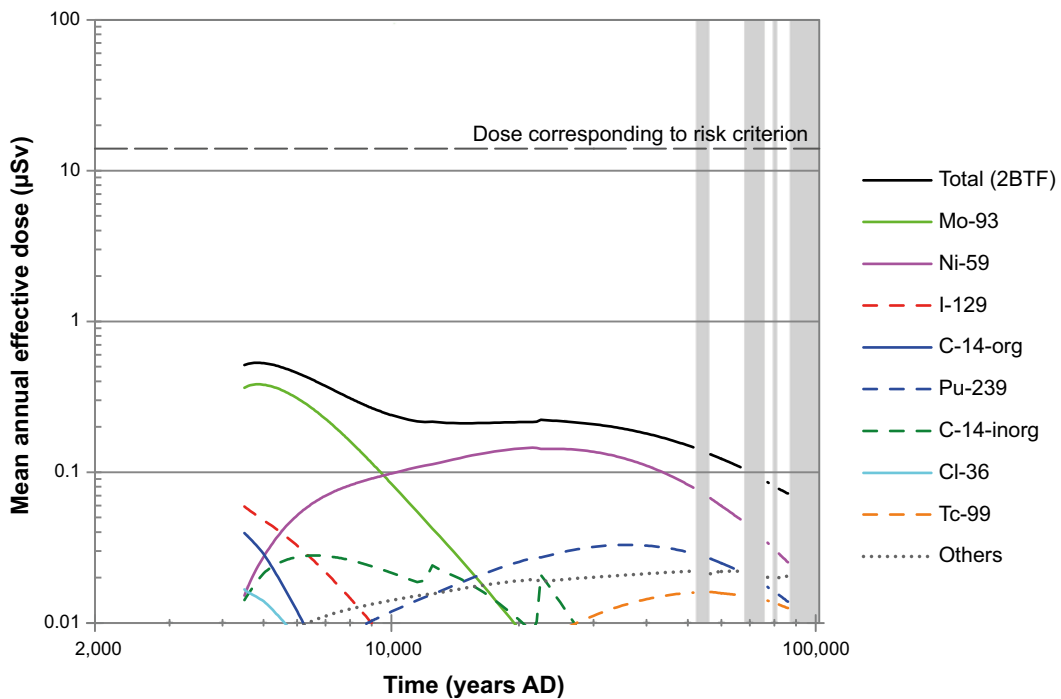
**Figure 9-31.** Arithmetic mean of the annual dose to the *drained-mire farmers* exposed group in biosphere object 157\_2 for releases from **1BMA** in the **high concentrations of complexing agents calculation case**. The unshaded areas correspond to temperate climatic conditions and the grey shaded areas to periglacial conditions with continuous permafrost.



**Figure 9-32.** Arithmetic mean of the annual dose to the *drained-mire farmers* exposed group in biosphere object 157\_2 for releases from **2BMA** in the **high concentrations of complexing agents calculation case**. The unshaded areas correspond to temperate climatic conditions and the grey shaded areas to periglacial conditions with continuous permafrost.



**Figure 9-33.** Arithmetic mean of the annual dose to the *drained-mire farmers* exposed group in biosphere object 157\_2 for releases from **1BTF** in the **high concentrations of complexing agents calculation case**. The unshaded areas correspond to temperate climatic conditions and the grey shaded areas to periglacial conditions with continuous permafrost.



**Figure 9-34.** Arithmetic mean of the annual dose to the *drained-mire farmers* exposed group in biosphere object 157\_2 for releases from **2BTF** in the **high concentrations of complexing agents calculation case**. The unshaded areas correspond to temperate climatic conditions and the grey shaded areas to periglacial conditions with continuous permafrost.

### 9.3.7 Wells downstream of the repository scenario

The *wells downstream of the repository scenario* is described in Section 7.6.7. Wells are also considered in the main scenario, both drilled wells and wells dug into the regolith in the biosphere objects. In this scenario, however, doses are calculated for the *garden plot household* exposed group assuming extraction of water from a well drilled into the bedrock in an area close enough to the repository to attract a certain amount of water containing radionuclides from the repository (i.e. in the well interaction area). A well in this area is assumed to capture 10% of the releases of each waste vault, which is a conservative conceptualisation derived from well cases investigated in Werner et al. (2013). In the calculation case, the life-time of the conceptual well is unlimited.

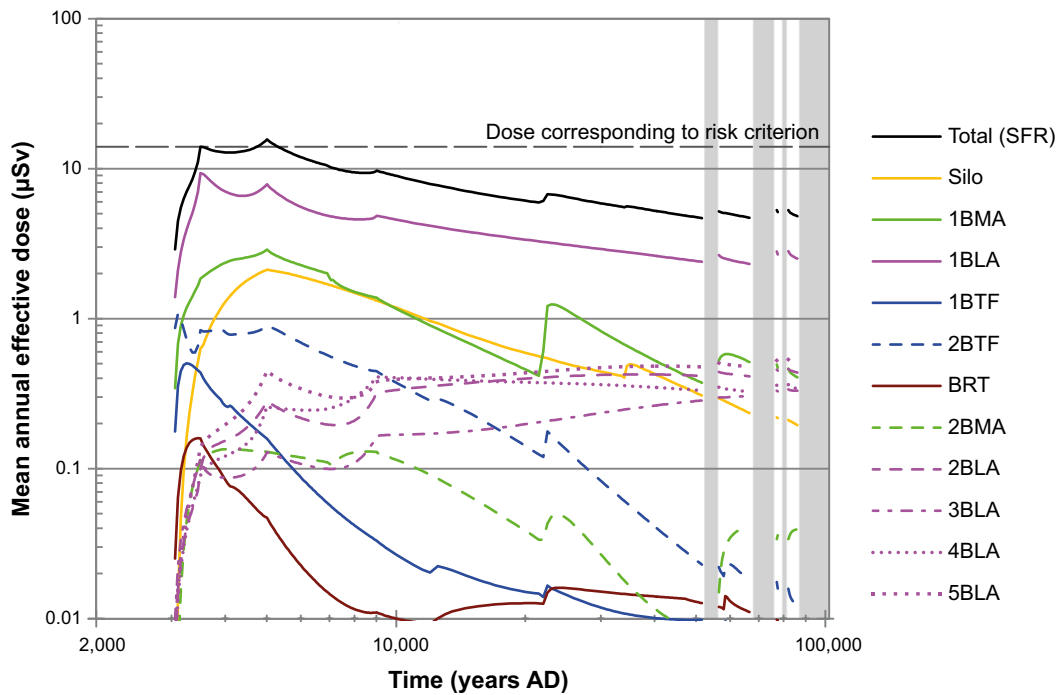
The peak annual effective dose is presented in Table 9-9, together with its year of occurrence, the contributions from the waste vaults and most relevant radionuclides.

The releases from the near-field and the far-field in this scenario are the same as in the *global warming calculation case*. The peak dose of 15.6 µSv exceeds the dose corresponding to the risk criterion. The peak dose occurs at 5000 AD, a relatively early point in time. Time series of annual effective doses are shown in Figure 9-35 for releases from each waste vault and for the total releases from the repository. For all waste vaults, a moderately decreasing trend of the doses is observed after the peak dose. The results show that Ac-227 contributes most to the peak dose; this dose is dominated by the exposure pathway related to ingestion of well water. The major part of the Ac-227 in the well water is due to releases from 1BLA. In contrast to the other scenarios with the peak dose occurring during the initial period of the temperate climate domain (but that do not consider drilled wells in the interaction area), peak dose is not dominated by Mo-93. Radionuclides of the decay-chains ( $4n$ ,  $4n+2$  and  $4n+3$ , see Table 8-2) contribute more than 60% to the peak annual dose.

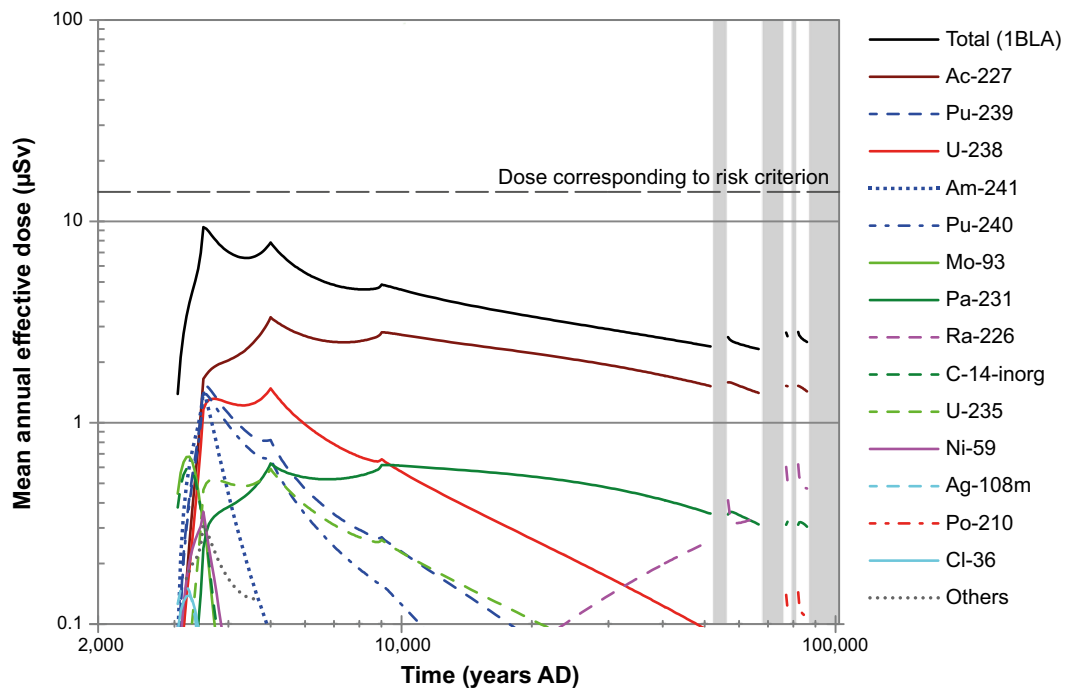
Radionuclide contributions from releases from 1BLA, 1BMA and the silo are presented in Figure 9-36, Figure 9-37 and Figure 9-38, respectively. In the case of the dominating waste vault 1BLA, the exposure is due to actinides and their progeny and to C-14-org in the period of highest occurring doses (Figure 9-36). For 1BMA, C-14 and I-129 together with Ag-108m dominate dose during the initial period (Figure 9-37). Pu-240 becomes dominating after the year 5000 AD and Ni-59 in the second period of temperate climate domain. The transition in the state of degradation around 22,000 AD causes a sharp increase in exposure due to these releases but without exceeding the initial peak for 1BMA at 3500 years AD. Exposure due to releases from the silo is completely dominated by C-14-org and I-129 (Figure 9-38).

**Table 9-9. Peak annual effective dose to a representative individual of the most exposed group obtained for the wells downstream the repository scenario.**

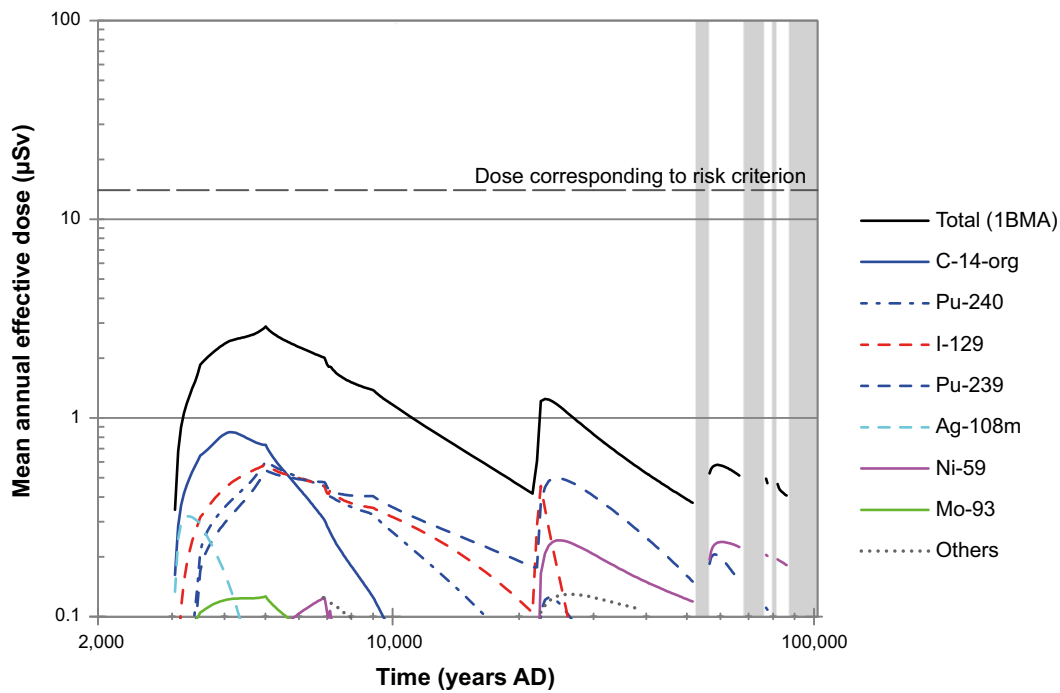
Annual dose [µSv]	Year [AD]	Contribution from waste vault (%)	Contribution from radionuclide (%)	Exposed group
15.6	5000	1BLA (50.2)	Ac-227 (21.8)	Garden plot household
		1BMA (18.4)	C-14-org (13.7)	
		Silo (16.0)	Pu-239 (11.5)	
		2BTF (5.8)	Pu-240 (10.9)	
		5BLA (2.9)	I-129 (10.3)	
		2BLA (1.8)	U-238 (9.5)	
		4BLA (1.7)	Mo-93 (4.5)	
		1BTF (1.0)	Pa-231 (4.1)	
		2BMA (0.8)	U-235 (3.9)	
		3BLA (0.8)	Ca-41 (1.9)	
		BRT (0.3)	Ni-59 (1.7)	
			Se-79 (1.2)	
			Others (5.1)	
			Others (5.9)	



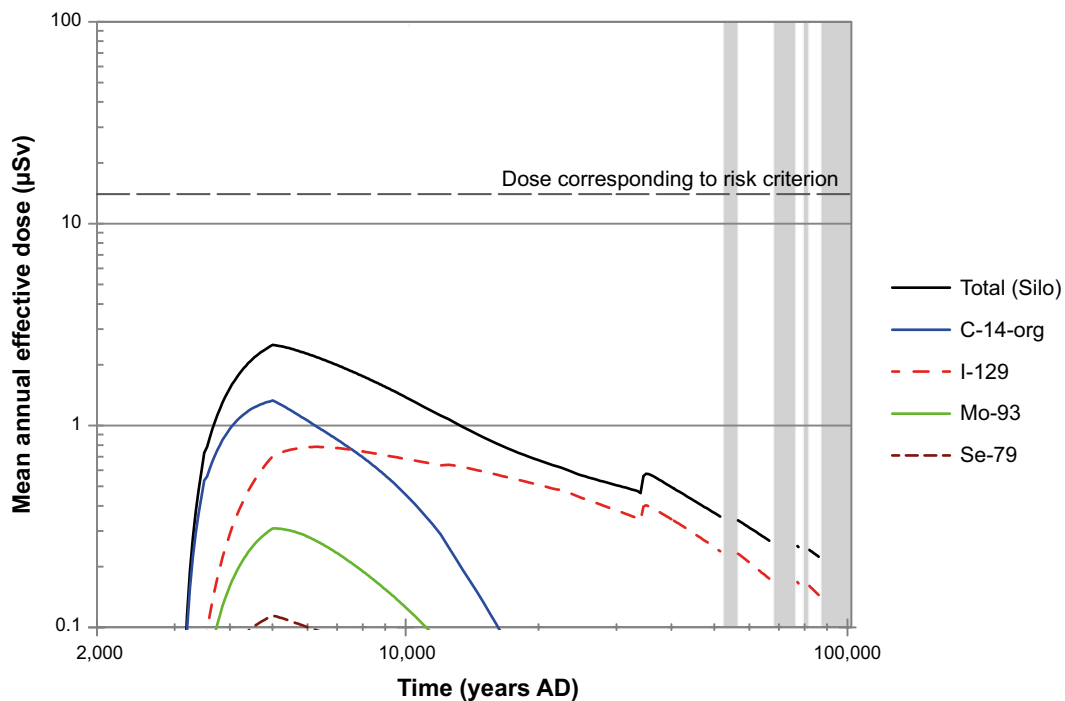
**Figure 9-35.** Arithmetic mean of the annual effective dose for the **garden plot household** exposed group for the repository and for each waste vault in the **wells downstream of the repository** calculation case. The sharp changes seen at 3500AD, 5000AD and 9000AD are due to the change of geosphere parameters in the modelling at these time steps corresponding to changes in shoreline position. The unshaded areas correspond to temperate climatic conditions and the grey shaded areas to periglacial conditions with continuous permafrost.



**Figure 9-36.** Arithmetic mean of the annual dose to the **garden plot household** exposed group for releases from **1BLA** in the **wells downstream of the repository** calculation case. The unshaded areas correspond to temperate climatic conditions and the grey shaded areas to periglacial conditions with continuous permafrost.



**Figure 9-37.** Arithmetic mean of the annual dose to the *garden plot household* exposed group for releases from *1BMA* in the *wells downstream of the repository* calculation case. The unshaded areas correspond to temperate climatic conditions and the grey shaded areas to periglacial conditions with continuous permafrost.



**Figure 9-38.** Arithmetic mean of the annual dose to the *garden plot household* exposed group for releases from the *silo* in the *wells downstream of the repository* calculation case. The unshaded areas correspond to temperate climatic conditions and the grey shaded areas to periglacial conditions with continuous permafrost.

### 9.3.8 Intrusion wells scenario

The *intrusion wells scenario* is described in Section 7.6.8. In this scenario, doses are calculated for the *garden plot household* exposed group utilising water abstracted from a well drilled straight down into a waste vault.

The peak doses for the garden plot household due to abstraction of water from the different waste vaults in the *intrusion wells calculation case*, as well as the radionuclide contributions to the peak dose are presented in Table 9-10. Time series of the annual effective doses to the exposed group are shown in Figure 9-39. The peak doses for the different waste vaults vary within a range from 40  $\mu\text{Sv}$  for BRT to about 4,500  $\mu\text{Sv}$  for 1BLA. The peak dose for 1BLA occurs shortly after it is assumed that wells can be drilled into the repository, i.e. when the shoreline has passed the footprint of the repository.

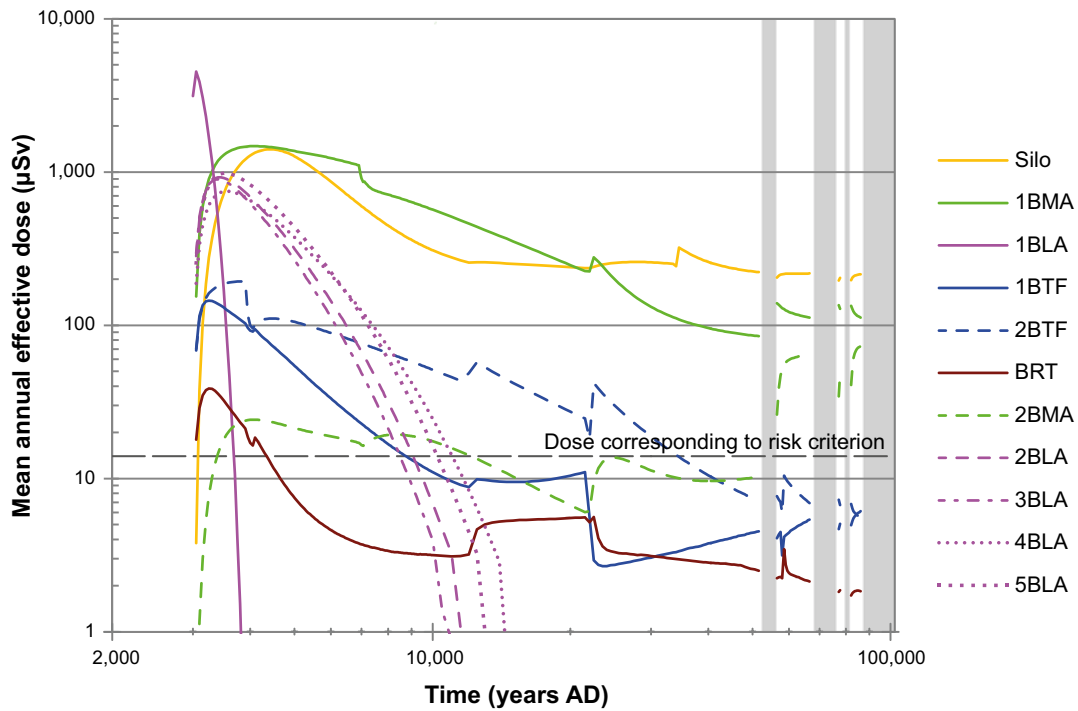
#### **1BLA intrusion well with alternative transport properties**

This variant, *1BLA intrusion well with alternative transport properties*, focuses on the impact of uncertainties in the transport properties of radionuclides included in decay chains. In this variant, the activity concentrations in the water of the 1BLA waste vault are decreased compared to the *global warming variant of the main scenario* with 1, 2, 3 and 4 orders of magnitude, respectively, in four different calculations.

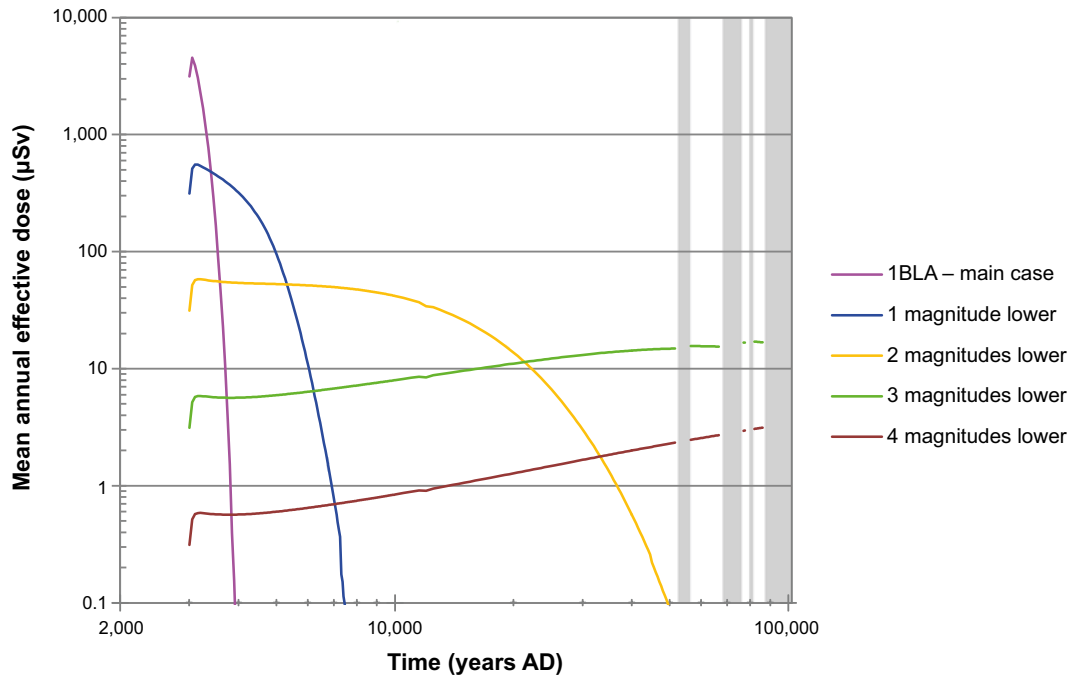
The resulting doses are shown in Figure 9-40. Assuming lower activity concentrations in the water of the waste vault, results in lower doses at the beginning of the analysed time period but to higher doses at later times. However, the peak dose for 1BLA in this alternative case is lower than for the *intrusion wells calculation case*. This shows that, even though a parent radionuclide is long-lived and has progeny with higher radiotoxicities, it is pessimistic to assume a high transport out from the waste vault as adopted in the *intrusion wells calculation case*.

**Table 9-10. Peak annual effective dose, for each waste vault, to a representative individual of the potentially most exposed group obtained for the *intrusion wells scenario*.**

<b>SFR 1</b>			
<b>Waste vault</b>	<b>Annual dose [<math>\mu\text{Sv}</math>]</b>	<b>Year [AD]</b>	<b>Contributions from radionuclides (%)</b>
Silo	1,406	4450	C-14-org (59.9), I-129 (23.9), Mo-93 (10.6), Se-79 (3.4), Cl-36 (1.1) and Others (1.1)
1BMA	1,474	4100	Pu-240 (34.0), Pu-239 (28.6), C-14-org (22.2), I-129 (7.7), Ag-108m (2.5), Mo-93 (1.6), Se-79 (1.1) and Others (2.3)
1BLA	4,524	3050	U-238 (30.3), Am-241 (17.8), Pu-239 (13.6), Pu-240 (12.8), U-235 (12.1), Ac-227 (6.5), Pa-231 (4.0), Tc-99 (1.0) and Others (1.9)
1BTF	145	3250	C-14-org (36.6), I-129 (34.0), Ag-108m (13.3), Mo-93 (11.3), Cs-135 (2.6), Cl-36 (1.0) and Others (1.2)
2BTF	194	3850	Pu-240 (40.6), Pu-239 (33.5), I-129 (9.0), C-14-org (5.0), Mo-93 (4.9), Ag-108m (2.9), Ni-59 (2.3) and Others (1.8)
<b>SFR 3</b>			
<b>Waste vault</b>	<b>Annual dose [<math>\mu\text{Sv}</math>]</b>	<b>Year [AD]</b>	<b>Contributions from radionuclides (%)</b>
2BMA	73	86,000	Po-210 (84.4), Ni-59 (10.6), Ra-226 (3.4) and Others (1.6)
2BLA	923	3450	Pu-239 (29.8), Pu-240 (28.4), Am-241 (18.7), U-235 (6.9), Ac-227 (5.2), U-238 (3.9), Pa-231 (3.1), Am-243 (1.5) and Others (2.7)
3BLA	897	3400	Pu-239 (29.4), Pu-240 (28.1), Am-241 (19.9), U-235 (6.8), Ac-227 (4.9), U-238 (3.8), Pa-231 (3.0), Am-243 (1.4) and Others (2.6)
4BLA	749	3550	Pu-239 (30.5), Pu-240 (28.9), Am-241 (16.3), U-235 (7.1), Ac-227 (5.7), U-238 (4.0), Pa-231 (3.4), Am-243 (1.5) and Others (2.7)
5BLA	982	3550	Pu-239 (30.5), Pu-240 (28.9), Am-241 (16.3), U-235 (7.1), Ac-227 (5.7), U-238 (4.0), Pa-231 (3.4), Am-243 (1.5) and Others (2.7)
BRT	39	3250	Ag-108m (63.4), Mo-93 (26.9), Ni-59 (5.8), Pu-240 (2.0), Pu-239 (1.5) and Others (0.4)



**Figure 9-39.** Arithmetic mean of the annual dose for the **garden plot household** exposed group for abstraction of water from any of the waste vaults in the **intrusion wells calculation case**. The unshaded areas correspond to temperate climatic conditions and the grey shaded areas to periglacial conditions with continuous permafrost.



**Figure 9-40.** Arithmetic mean of the annual dose for the **garden plot household** exposed group for abstraction of water from the **1BLA** waste vault in the variant of the **1BLA intrusion well with alternative transport properties** assuming 1 to 4 magnitudes lower activity concentration in the water. For comparison the results from the **intrusion wells calculation case** for **1BLA** is shown (also shown in Figure 9-39). The unshaded areas correspond to temperate climatic conditions and the grey shaded areas to periglacial conditions with continuous permafrost.



## 9.4 Results for the residual scenarios

The residual scenarios are presented in Section 7.7. The results of the calculations of annual effective doses to humans for these scenarios are presented in Sections 9.4.1 to 9.4.8 below.

### 9.4.1 Loss of barrier function scenario – no sorption in the repository

The *loss of barrier function scenario – no sorption in the repository* is described in Section 7.7.1. In this scenario, radionuclides do not sorb at all in the repository, i.e.  $K_d$  values for the repository materials are assumed to be zero.

The peak dose and the contributions from waste vaults and radionuclides for this scenario are presented in Table 9-11. The peak dose (41.4  $\mu\text{Sv}$ ) is about 5 times higher than the peak dose for the *global warming variant of the main scenario* and occurs about 20,000 years later (see Table 9-11 and 9-1). As for other scenarios with lower retention of radionuclides in the near-field compared with the main scenario, the relative dose contributions from the silo, 1BMA and 2BMA become more important. The silo and 1BMA contribute 88% of the peak dose and 2BMA contributes another 8%. The radionuclides Ni-59, Pu-239 and Pu-240, which are less mobile radionuclides in the main scenario, account for 92% of the peak dose.

It is worth noting that, although the peak dose increases by almost one order of magnitude compared with the main scenario, the increase in contributions from strongly sorbing radionuclides is much larger. These results highlight that sorption in the near-field contributes significantly to the safety function good retention.

**Table 9-11. Peak annual effective dose to a representative individual of the most exposed group obtained for the *loss of barrier function scenario – no sorption in the repository*.**

Annual dose [ $\mu\text{Sv}$ ]	Year [AD]	Contribution from waste vault (%)	Contribution from radionuclide (%)	Exposed group (biosphere object)
41.4	25,500	Silo (62.2)	Ni-59 (77.3)	Drained-mire farmer (Object 157_2)
		1BMA (25.4)	Pu-239 (12.3)	
		2BMA (8.1)	Pu-240 (2.8)	
		1BLA (1.5)	Ca-41 (1.1)	
		1BTF (0.8)	Tc-99 (1.0)	
		BRT (0.9)	Mo-93 (1.0)	
		2BTF (0.6)	Others (4.4)	
		5BLA (0.2)		
		4BLA (0.2)		
		2BLA (0.2)		
		3BLA (0.1)		

### 9.4.2 Loss of barrier function scenario – no sorption in the bedrock

The *loss of barrier function scenario – no sorption in the bedrock* is described in Section 7.7.2. In this scenario, sorption of radionuclides does not occur in the bedrock, i.e.  $K_d$  values for the bedrock are assumed to be zero.

The peak dose and the contributions from waste vaults and radionuclides for this scenario are presented in Table 9-12. The peak dose (10.4  $\mu\text{Sv}$ ) is slightly higher than the estimate for the *global warming variant of the main scenario* and is observed 400 years earlier than in the *global warming calculation case* and 100 years later than for the *timing of releases calculation case*. The BLA waste vaults contribute more to the peak dose in this scenario compared with the main scenario. This is particularly clear for 1BLA that together with the silo contributes most to the peak dose in this calculation case. U-238 originating from 1BLA is a key radionuclide in this scenario, contributing about 15% to the peak dose. By comparing with the scenario *loss of barrier function scenario – no sorption in the repository* (Section 9.4.1) it is evident that sorption in the far-field is relevant but, less important for the mitigation of exposure than sorption in the near-field.

**Table 9-12. Peak annual effective dose to a representative individual of the most exposed group obtained for the *loss of barrier function scenario – no sorption in the bedrock*.**

Annual dose [ $\mu\text{Sv}$ ]	Year [AD]	Contribution from waste vault (%)	Contribution from radionuclide (%)	Exposed group (biosphere object)
10.4	6100	Silo (32.4)	Mo-93 (41.3)	Drained-mire farmer
		1BLA (22.6)	U-238 (15.3)	(Object 157_2)
		1BMA (12.2)	C-14-org (14.7)	
		2BMA (5.6)	U-235 (10.5)	
		3BLA (4.4)	I-129 (4.2)	
		2BTF (4.3)	Pa-231 (3.9)	
		2BLA (4.2)	Cl-36 (2.6)	
		5BLA (3.9)	Ac-227 (2.0)	
		4BLA (3.8)	Ca-41 (1.9)	
		BRT (3.4)	Others (3.7)	
		1BTF (3.4)		

### 9.4.3 Loss of barrier function scenario – high water flow in the repository

The *loss of barrier function scenario – high water flow in the repository* is described in Section 7.7.3. Near-field water flow, porosities and diffusivities for (from the beginning) completely degraded concrete and bentonite barriers were applied in this scenario.

The peak dose and the contributions from waste vaults and radionuclides for this scenario are presented in Table 9-13. The peak dose in this scenario is one order of magnitude higher than the peak dose in the *global warming variant of the main scenario* (Table 9-1). Some of the radionuclides, i.e. Mo-93, inorganic C-14 and I-129, that contribute significantly to the peak dose (at 4650 AD) in this calculation case are also relevant in the *global warming calculation case*. However, Ni-59 also contributes significantly to the peak dose in this calculation case whereas Ni-59 starts to be important for the dose later in the main scenario. The results demonstrate that the hydraulic barriers in the near-field are important to the long-term safety of the repository.

**Table 9-13. Peak annual effective dose to a representative individual of the most exposed group obtained for the *loss of barrier function scenario – high water flow in the repository*.**

Annual dose [ $\mu\text{Sv}$ ]	Year [AD]	Contribution from waste vault (%)	Contribution from radionuclide (%)	Exposed group (biosphere object)
68.8	4650	Silo (73.3)	Mo-93 (72.2)	Drained-mire farmer
		1BMA (13.2)	C-14-inorg (13.1)	(Object 157_2)
		2BMA (9.7)	Ni-59 (6.6)	
		2BTF (1.1)	I-129 (4.8)	
		1BLA (1.0)	Others (3.3)	
		1BTF (0.9)		
		BRT (0.3)		
		2BLA (0.2)		
		3BLA (0.2)		
		4BLA (0.1)		
		5BLA (0.1)		

### 9.4.4 Changed repository redox conditions in SFR 1 scenario

The *changed repository redox conditions in SFR 1 scenario* is described in Section 7.7.4. In the analysis of this scenario an alternative set of sorption partition coefficients,  $K_d$  values, is used for the redox-sensitive elements Np, Pa, Se, Tc, U and Pu. The peak dose and the contributions from waste vaults and radionuclides for this scenario are presented in Table 9-14. The peak dose obtained for this scenario (7.4  $\mu\text{Sv}$ ) is 1.1  $\mu\text{Sv}$  higher than the dose contribution from SFR 1 (6.3  $\mu\text{Sv}$ ) to the peak dose in the *global warming calculation case*. The peak dose occurs about 45,000 years later

in this scenario and has a different set of contributing radionuclides, but a comparable distribution with respect to contributions from the waste vaults (see Table 9-14 and 9-1). The late peak is due to the long lasting build-up of dose from Pu-239 dominating after 15,000 years AD and, after 30,000 years AD, exceeding the peak contribution from Mo-93, see the **Radionuclide transport report**. When the peak dose is reached, after 50,000 years AD, the two main contributing radionuclides of the *global warming variant of the main scenario*, Mo-93 and C-14, have largely decayed.

The results indicates that the redox conditions assumed for this scenario impact the evolution of releases from the repository but have very limited significance with respect to long-term safety.

**Table 9-14. Peak annual effective dose to a representative individual of the most exposed group obtained for the *changed repository redox conditions in SFR 1 scenario*.**

Annual dose [ $\mu$ Sv]	Year [AD]	Contribution from waste vault (%)	Contribution from radionuclide (%)	Exposed group (biosphere object)
7.4	51,500	Silo (59.4)	Pu-239 (53.8)	Drained-mire farmer
		1BMA (29.1)	Ni-59 (18.8)	(Object 157_2)
		1BLA (7.5)	Tc-99 (11.0)	
		1BTF (2.1)	Cs-135 (3.8)	
		2BTF (1.9)	Pa-231 (3.0)	
			Ra-226 (2.0)	
			I-129 (1.8)	
			Pu-240 (1.6)	
			Ac-227 (1.3)	
			Pu-242 (1.2)	
			Others (1.8)	

#### 9.4.5 Extended global warming scenario

The *extended global warming scenario* is described in Section 7.7.5. In this scenario, temperate climate conditions prevail during the entire assessment period.

Higher precipitation leads to an increased horizontal flux of groundwater increasing the rapidity of groundwater transport, but increasing also the dilution of radionuclides in surface water and surface peat (see the **Biosphere synthesis report**). This explains both the earlier peak (occurring 350 years earlier) and the slightly lower peak dose (7.0  $\mu$ Sv) of the *extended global warming calculation case* (Table 9-15) compared with the *global warming calculation case* (Table 9-1). Apart from these small differences, the *extended global warming scenario* is very similar to the *global warming calculation case* in terms of contribution to dose from waste vaults and dominating radionuclides.

**Table 9-15. Peak annual effective dose to a representative individual of the most exposed group obtained for the *extended global warming scenario*.**

Annual dose [ $\mu$ Sv]	Year [AD]	Contribution from waste vault (%)	Contribution from radionuclide (%)	Exposed group (biosphere object)
7.0	6150	Silo (45.2)	Mo-93 (54.3)	Drained-mire farmer
		1BMA (16.5)	C-14-org (22.1)	(Object 157_2)
		1BLA (11.9)	U-238 (6.5)	
		2BMA (7.5)	I-129 (5.7)	
		2BTF (5.3)	Cl-36 (3.4)	
		1BTF (4.4)	U-235 (2.7)	
		BRT (4.3)	Ca-41 (2.4)	
		2BLA (1.3)	Others (2.9)	
		5BLA (1.3)		
		3BLA (1.3)		
		4BLA (1.2)		

### 9.4.6 Unclosed repository scenario

The *unclosed repository scenario* is described in Section 7.7.6. Two different inventories are considered when analysing this scenario: one is the inventory disposed in SFR (i.e. the best estimate of the inventory used in the other calculations) and the other includes additionally SFL waste brought into SFR for interim storage only. The simulations to calculate radionuclide concentrations at the tunnel entrance are performed deterministically and the only exposure pathway considered is drinking of water from the tunnel entrance.

The resulting peak doses from ingestion of water, and the contributions to the peak dose from radionuclides for this calculation case are presented in Table 9-16. The peak doses are in the order of tens of mSv if only the SFR inventory is considered. If long-lived waste, temporarily stored in SFR, is not removed, the effective dose rises above 0.5 Sv. These results clearly demonstrate the importance of adequate closure and sealing of the repository.

**Table 9-16. Peak annual effective dose to a representative individual of the most exposed group (drinking water pathway) obtained for the *unclosed repository scenario*.**

Case	Annual dose [μSv]	Year [AD]	Contribution from radionuclide (%)
Considering only inventory disposed in SFR	13,300	(a)	Cs-137 (63.3) Ni-63 (28.1) Sr-90 (3.3) Am-241 (2.4)
Considering also the inventory of SFL waste that is temporarily stored in SFR	548,000	(a)	Ni-63 (91.3) C-14-ind (5.1) Cs-137 (1.6) Mo-93 (1.1)

<sup>(a)</sup> 100 years after the unclosed repository is abandoned.

### 9.4.7 Scenarios related to future human actions (FHA)

Three scenarios related to FHAs are discussed in Section 7.7.7. The *FHA scenario – drilling into the repository* is the only one analysed in terms of radiation doses, the other two are addressed in a more qualitative manner. The dose results from the calculations related to the *FHA scenario – drilling into the repository* are summarised below. Detailed results and the discussion regarding the other scenarios are provided in the **FHA report**.

#### ***FHA scenario – drilling into the repository***

##### **Exposure of the on-site crew during a drilling event**

Doses were calculated for two different drilling techniques (rotary drilling with air and diamond core drilling) and for four waste vaults (silo, 1BMA, 2BMA and 1BLA), i.e. results are obtained for a set of eight variants.

The highest dose obtained for the on-site drilling crew was 250 μSv at year 3000 AD, when drilling into the silo using the rotary drilling technique. The doses are dominated by Am-241 (Figure 9-41). Intrusion into 1BMA, 2BMA and 1BLA using the same drilling technique results in peak doses 2 orders of magnitude lower than for intrusion into the silo at 3000 AD. Before 3000AD the footprint of the repository is below sea level, hence no drilling is expected to take place before this time point.

The most significant result from this set of calculations is that all the doses are below the ranges of ICRP reference levels (ICRP 2013) indicative of system robustness, i.e. for an existing exposure situation, a few mSv per year, and for an emergency exposure, 20–100 mSv. That is, these illustrative results do not give rise to concern relative to reference levels set in the context of either existing situations or emergency situations. This is a clear indicator of safety system robustness to FHA linked to human intrusion by drilling. Similar conclusions can be drawn in comparison with the recommendations

of IAEA (IAEA 2011). That is, even the largest doses fall below the range of 1–20 mSv, at which reasonable efforts are warranted at the stage of development of the facility to reduce the probability of intrusion or to limit its consequences by means of optimisation of the repository’s design.

### Exposure during construction on drilling detritus landfill

Doses were calculated for the drilling technique using rotary drilling with air and for four waste vaults (silo, 1BMA, 2BMA and 1BLA), i.e. results are obtained for a set of four variants.

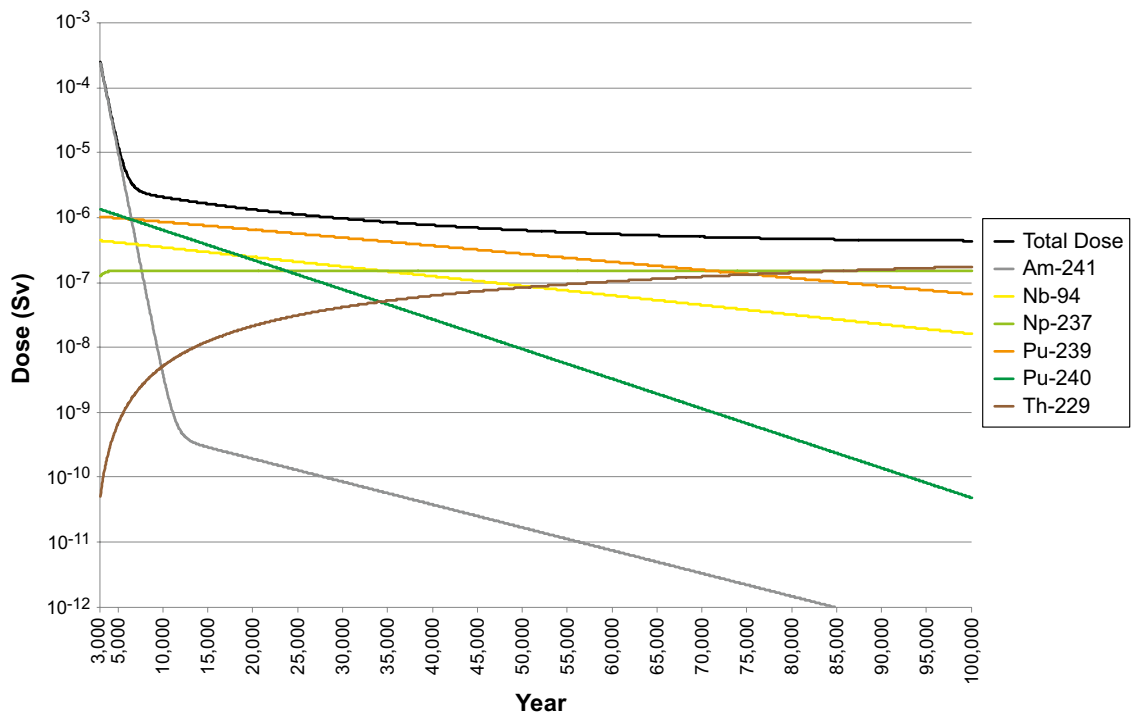
The construction worker utilising the landfill containing drilling detritus receives a small dose in a year of work compared to the dose to the on-site crew during the drilling event. The highest dose to a construction worker was 6  $\mu$ Sv in a year at year 3000 AD when the landfill contains drilling detritus from the silo (Figure 9-42). The peak dose at year 3000 AD is dominated by Am-241, but thereafter Nb-94 contributes most to dose during the rest of the assessment period (Figure 9-42).

The peak doses for construction on a landfill containing drilling detritus from 1BMA and 2BMA are 20 and 4 times lower, respectively, than for a landfill containing drilling detritus from the silo at year 3000 AD. Construction on landfill containing drilling detritus from 1BLA result in a dose 3 orders of magnitude lower than for a construction on landfill containing drilling detritus from the silo at year 3000 AD. The peak dose for 1BLA however, occurs later, at 100,000 AD, but is still 2 orders of magnitude lower than the peak dose for the silo.

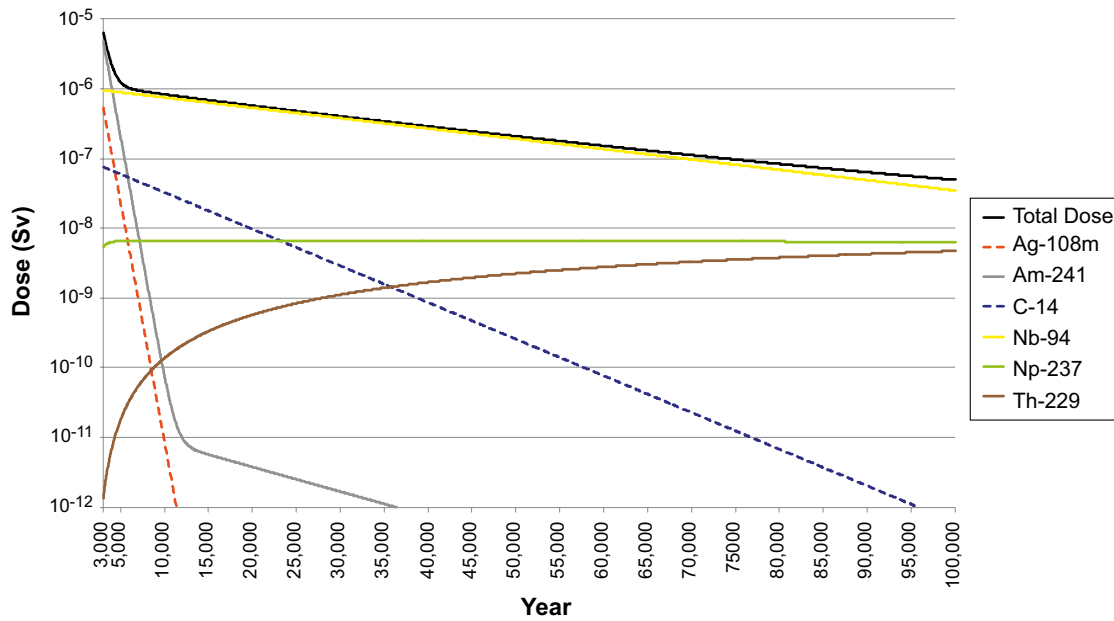
### Exposure due to cultivation on drilling detritus landfill

Doses were calculated for the drilling technique using rotary drilling with air and for four waste vaults (silo, 1BMA, 2BMA and 1BLA), i.e. results for this scenario are obtained for a set of four variants.

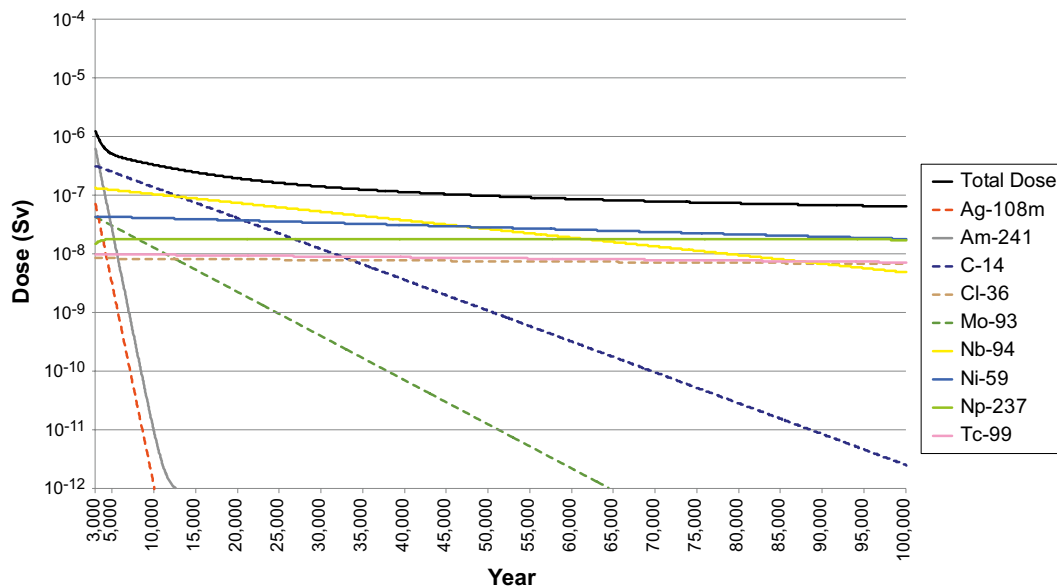
The resulting doses in a year to humans are low compared to the dose to the on-site crew during the drilling event. The highest dose was 1  $\mu$ Sv in a year at year 3000 AD, when the landfill used for cultivation contains drilling detritus from the silo (Figure 9-43). The peak dose at year 3000 AD is dominated by Am-241 and C-14, but at the end of the assessment period the long-lived radionuclides Ni-59 and Np-237 contribute most to dose.



**Figure 9-41.** Dose in the FHA scenario – drilling into the repository related to exposure of the on-site crew during the drilling event, for the combination of using the rotary drilling with air technique while drilling into the silo (from the FHA report Figure 5-2a).



**Figure 9-42.** Dose in a year in the *FHA scenario – drilling into the repository related to exposure during construction on drilling detritus landfill*, for a landfill containing drilling detritus from the silo (from the *FHA report Figure 5-4a*).



**Figure 9-43.** Dose in a year in the *FHA scenario – drilling into the repository related to exposure due to cultivation on drilling detritus landfill*, for a landfill containing drilling detritus from the silo (from the *FHA report Figure 5-6a*).

The peak doses for a landfill used for cultivation containing drilling detritus from 1BMA, 2BMA and 1BLA are about 3, 5 and 30 times lower, respectively, than for a landfill containing drilling detritus from the silo at 3000 AD. In comparison with utilising the drill hole as a well (Section 9.3.8), the doses due to cultivation on a landfill containing drilling detritus are negligible.

### 9.4.8 Glacial and post-glacial conditions scenario

The *glacial and post-glacial conditions scenario* is described in Section 7.7.8.

Time series of annual effective doses to the exposed groups in biosphere object 157\_2 and the maximum effective annual dose for the corresponding calculation case are presented in Figure 9-44. For comparison also the maximum dose of the *global warming calculation case* of the main scenario are shown.

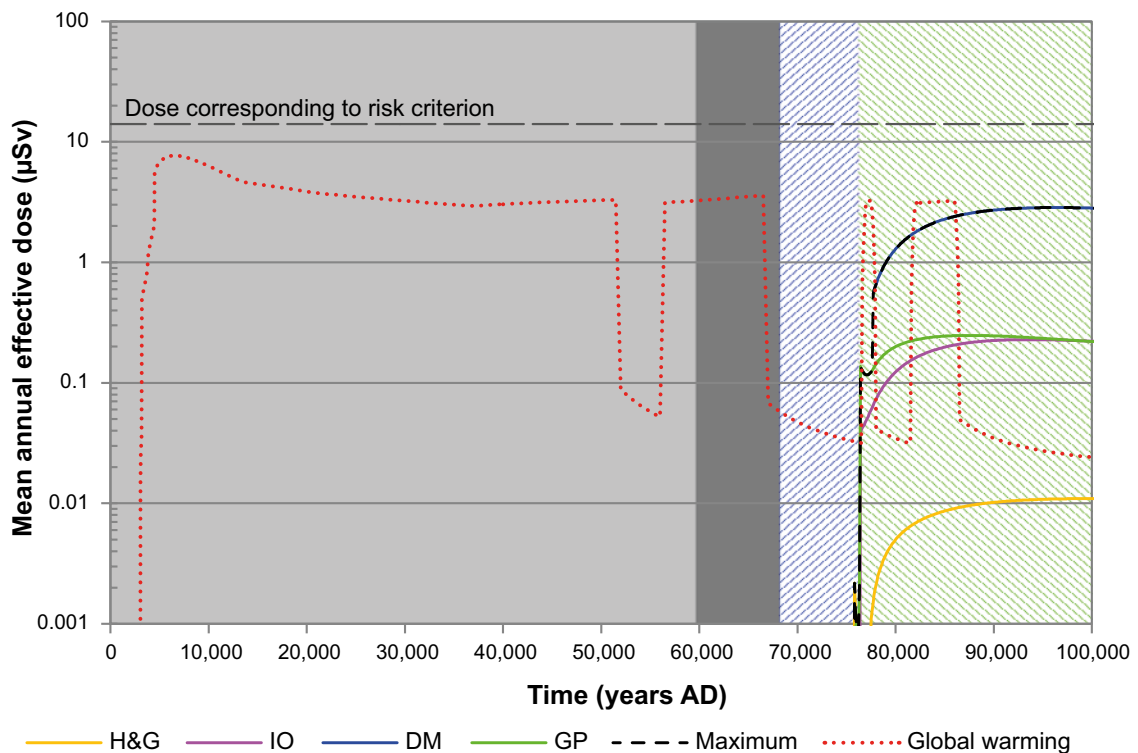
With the land having risen above sea level, the maximum dose is soon defined by the exposure of *drained-mire farmers*, but the peak dose is not reached until 95,000 AD (Table 9-17).

The silo and the 1BMA vault contribute more than 80% of the peak dose (Table 9-17). The five BLA vaults do not contribute significantly to the peak dose, i.e. their contribution is below 0.05% each. The dominating radionuclide is Ni-59 contributing more than 75%, while another 15% is contributed by Ra-228 and Pu-239.

## 9.5 Results for scenario combinations

### 9.5.1 Scenario combination 1

The *scenario combination 1* addresses the combination of scenarios *high flow in the bedrock* and *accelerated concrete degradation* as described in Section 7.8 with the corresponding calculation case in Section 8.6.1.



**Figure 9-44.** Arithmetic mean of annual dose for exposed groups in biosphere object 157\_2 and the maximum for all biosphere objects in the *glacial and post-glacial conditions calculation case*. Maximum dose for the *global warming calculation case* is also shown for comparison. H&G – hunters and gatherers, IO – infield–outland farmers, DM – drained-mire farmers, and GP – garden plot household. The grey shaded area indicates temperate and periglacial conditions without radionuclide releases to the biosphere; dark grey area indicates glacial conditions. The hatched areas indicate temperate conditions, blue for submerged and green for terrestrial periods.

**Table 9-17. Peak annual effective dose to a representative individual of the most exposed group obtained for the *glacial and post-glacial conditions scenario*.**

Annual dose [ $\mu$ Sv]	Year [AD]	Contribution from waste vault (%)	Contribution from radionuclide (%)	Exposed group (biosphere object)
2.8	94,400	Silo (50.6)	Ni-59 (77.6)	Drained-mire farmer (Object 157_2)
		1BMA (30.9)	Ra-226 (8.2)	
		2BMA (13.6)	Pu-239 (7.2)	
		BRT (3.0)	Tc-99 (2.2)	
		1BTF (1.4)	Others (4.8)	
		2BTF (0.6)		
		1BLA (0.0)		
		2BLA (0.0)		
		3BLA (0.0)		
		4BLA (0.0)		
		5BLA (0.0)		

The results for this scenario combination are given in Table 9-18. The peak dose of 15.5  $\mu$ Sv is about 5  $\mu$ Sv higher than in the corresponding calculation cases for the single scenarios and occurs 550 years later than in the *accelerated concrete degradation scenario* and 150 years earlier than in the *high flow in the bedrock scenario*. The most dose contributing radionuclides are similar in the single scenario cases and in the combined case with Mo-93 and C-14-org contributing 77% of the peak dose.

Notably, the silo contributes only about 29% to peak dose, whereas it contributes 34 and 44% in the single scenario cases, respectively. On the other hand, 2BMA contributes 24% in the combined scenario but not more than 12% in the single scenarios. The contribution of 1BMA (27%) is between the contributions of 34% and 15% of the single scenarios.

**Table 9-18. Peak annual effective dose to a representative individual of the most exposed group obtained for *Scenario combination 1*.**

Annual dose [ $\mu$ Sv]	Year [AD]	Contribution from waste vault (%)	Contribution from radionuclide (%)	Exposed group (biosphere object)
15.5	5700	Silo (29.1)	Mo-93 (66.3)	Drained-mire farmer (Object 157_2)
		1BMA (26.8)	C-14-org (10.3)	
		2BMA (23.8)	I-129 (5.2)	
		1BLA (7.4)	U-238 (4.1)	
		2BTF (3.8)	C-14-inorg (3.9)	
		1BTF (2.9)	Ni-59 (2.6)	
		BRT (2.9)	Cl-36 (2.3)	
		4BLA (0.9)	Ca-41 (1.8)	
		5BLA (0.9)	U-235 (1.8)	
		2BLA (0.8)	Others (1.7)	
		3BLA (0.8)		

## 9.5.2 Scenario combination 2

The *scenario combination 2* addresses the combination of scenarios *high flow in the bedrock* and *high concentrations of complexing agents* as described in Section 7.8 with the corresponding calculation case in Section 8.6.2.

The results for this combination of scenarios are given in Table 9-19. The peak dose of 13.3  $\mu$ Sv is 2  $\mu$ Sv lower than the peak dose of *scenario combination 1* and occurs late, at 40,000 AD. This is 4,500 years earlier than in the *high concentrations of complexing agents scenario* and is 25% higher than in that scenario. Relative contributions from waste vaults and radionuclides are similar to those in the *high concentrations of complexing agents scenario*. Radionuclide contributions are clearly dominated by Ni-59 (nearly 80%). 1BMA and the silo are together responsible for more than 80% of the peak dose at 40,000 AD.



**Table 9-19. Peak annual effective dose to a representative individual of the most exposed group obtained for Scenario combination 2.**

Annual dose [μSv]	Year [AD]	Contribution from waste vault (%)	Contribution from radionuclide (%)	Exposed group (biosphere object)
13.3	40,000	1BMA (50.2)	Ni-59 (78.0)	Drained-mire farmer (Object 157_2)
		Silo (32.0)	Pu-239 (8.4)	
		2BMA (8.0)	Pa-231 (2.3)	
		1BLA (4.1)	Cs-135 (1.9)	
		2BTF (1.3)	Ca-41 (1.7)	
		BRT (1.1)	Tc-99 (1.5)	
		4BLA (0.8)	I-129 (1.4)	
		5BLA (0.7)	Ac-227 (1.3)	
		1BTF (0.7)	Ra-226 (1.1)	
		2BLA (0.6)	Others (2.4)	
		3BLA (0.5)		

## 9.6 Summary of peak doses to humans

This chapter has presented the results from calculations of doses to humans that were calculated for the scenarios and calculation cases presented in Chapter 7 and 8. These results are summarised in tabular form (see Tables 9-20 and 9-21) and shown graphically in Figure 9-45.

**Table 9-20. Summary of the peak doses to humans, year of occurrence, and most contributing waste vault and radionuclides, in the analyses of the main scenario and the less probable scenarios.**

Scenario	Peak dose [μSv]	Year [AD]	Waste vault (%)	Radionuclide (%)	
<b>Main scenario</b>					
Global warming variant	7.7	6500	Silo (45.3)	Mo-93 (57.7)	C-14-org (17.9)
Timing of the releases	8.2	6000	Silo (45.8)	Mo-93 (61.4)	C-14-org (17.9)
Early periglacial variant	0.28	17,800	Silo (59.4)	I-129 (71.7)	Ca-41 (7.9)
Collective dose <sup>(a)</sup>	2.5 manSv	–		C-14 (100)	
Collective dose <sup>(b)</sup>	0.15 manSv	–		C-14 (96.4)	Ag-108m (3.2)
<b>Less probable scenarios</b>					
High inventory scenario	17.7	7500	Silo (52.3)	Mo-93 (47.3)	Se-79 (15.1)
High flow in the bedrock scenario	9.7	6250	Silo (44.3)	Mo-93 (58.1)	C-14-org (17.4)
Accelerated concrete degradation scenario	10.6	5550	1BMA (33.6)	Mo-93 (59.8)	C-14-org (17.0)
Bentonite degradation scenario	7.7	6500	Silo (45.3)	Mo-93 (57.7)	C-14-org (17.9)
Earthquake scenario	26.7	4550	Silo (100)	Mo-93 (71.1)	C-14-inorg (9.0)
High concentrations of complexing agents scenario	10.7	44,500	1BMA (46.5)	Ni-59 (75.7)	Pu-239 (8.5)
Wells downstream of the repository scenario	15.6	5000	1BLA (50.2)	Ac-227 (21.8)	C-14-org (12.0)
Intrusion wells scenario (Silo)	1,406	4450	Silo (100)	C-14-org (59.9)	I-129 (23.9)
Intrusion wells scenario (1BMA)	1,474	4100	1BMA (100)	Pu-240 (34.0)	Pu-239 (28.6)
Intrusion wells scenario (2BMA)	73	86,000	2BMA (100)	Po-210 (84.4)	Ni-59 (10.6)
Intrusion wells scenario (1BTF)	145	3250	1BTF (100)	C-14-org (36.6)	I-129 (34.0)
Intrusion wells scenario (2BTF)	194	3850	2BTF (100)	Pu-240 (40.6)	Pu-239 (33.5)
Intrusion wells scenario (BRT)	39	3250	BRT (100)	Ag-108m (63.4)	Mo-93 (26.9)
Intrusion wells scenario (1BLA)	4,524	3050	1BLA (100)	U-238 (30.3)	Am-241 (17.8)
Intrusion wells scenario (2BLA)	923	3450	2BLA (100)	Pu-239 (29.8)	Pu-240 (28.4)
Intrusion wells scenario (3BLA)	897	3400	3BLA (100)	Pu-239 (29.4)	Pu-240 (28.1)
Intrusion wells scenario (4BLA)	749	3550	4BLA (100)	Pu-239 (30.5)	Pu-240 (28.9)
Intrusion wells scenario (5BLA)	982	3550	5BLA (100)	Pu-239 (30.5)	Pu-240 (28.9)

(a) For the global population due to C-14 releases to the atmosphere.

(b) For the Baltic population due to radionuclide releases to the Baltic Sea and subsequent exposure of the population by ingestion of fish.

**Table 9-21. Summary of the peak doses to humans, year of occurrence, and most contributing waste vault and radionuclides, in the analyses of the residual scenarios.**

Scenario	Peak dose [μSv]	Year [AD]	Waste vault (%)	Radionuclide (%)	
<b>Residual scenarios</b>					
Loss of barrier function scenario – no sorption in the repository	41.4	25,500	Silo (62.2)	Ni-59 (77.3)	Pu-239 (12.3)
Loss of barrier function scenario – no sorption in the bedrock	10.4	6100	Silo (32.4)	Mo-93 (41.3)	U-238 (15.3)
Loss of barrier function scenario – high water flow in the repository	68.8	4650	Silo (73.3)	Mo-93 (72.2)	C-14-inorg (13.1)
Changed repository redox conditions in SFR 1 scenario	7.4	51,500	Silo (59.4)	Pu-239 (53.8)	Ni-59 (18.8)
Glacial and post-glacial conditions scenario	2.8	96,400	Silo (50.6)	Ni-59 (77.6)	Ra-226 (8.2)
Extended global warming scenario	7.0	6150	Silo (45.2)	Mo-93 (54.3)	C-14-org (22.1)
Unclosed repository scenario <sup>(a)</sup>	13,300	(c)	n.a.	Cs-137 (63.3)	Ni-63 (28.1)
Unclosed repository scenario <sup>(b)</sup>	548,000	(c)	n.a.	Ni-63 (91.3)	C-14-ind (5.1)
FHA scenario – drilling into the repository					
exposure of the on-site crew during the drilling event	250	3000	Silo (100)	Am-241 (98.7)	Pu-240 (0.5)
exposure during construction on drilling detritus landfill)	6.5	3000	Silo (100)	Am-241 (74.7)	Nb-94 (14.7)
exposure due to cultivation on drilling detritus landfill)	1.2	3000	Silo (100)	Am-241 (48.8)	C-14 (25.5)
<b>Scenario combinations</b>					
Scenario combination 1	15.5	5700	Silo (29.1)	Mo-93 (66.3)	C-14-org (10.3)
Scenario combination 2	13.3	40,000	1BMA (50.2)	Ni-59 (78.0)	Pu-239 (8.4)

(a) Considering only the inventory disposed in SFR.

(b) Considering also the inventory of SFL waste that is temporarily stored in SFR.

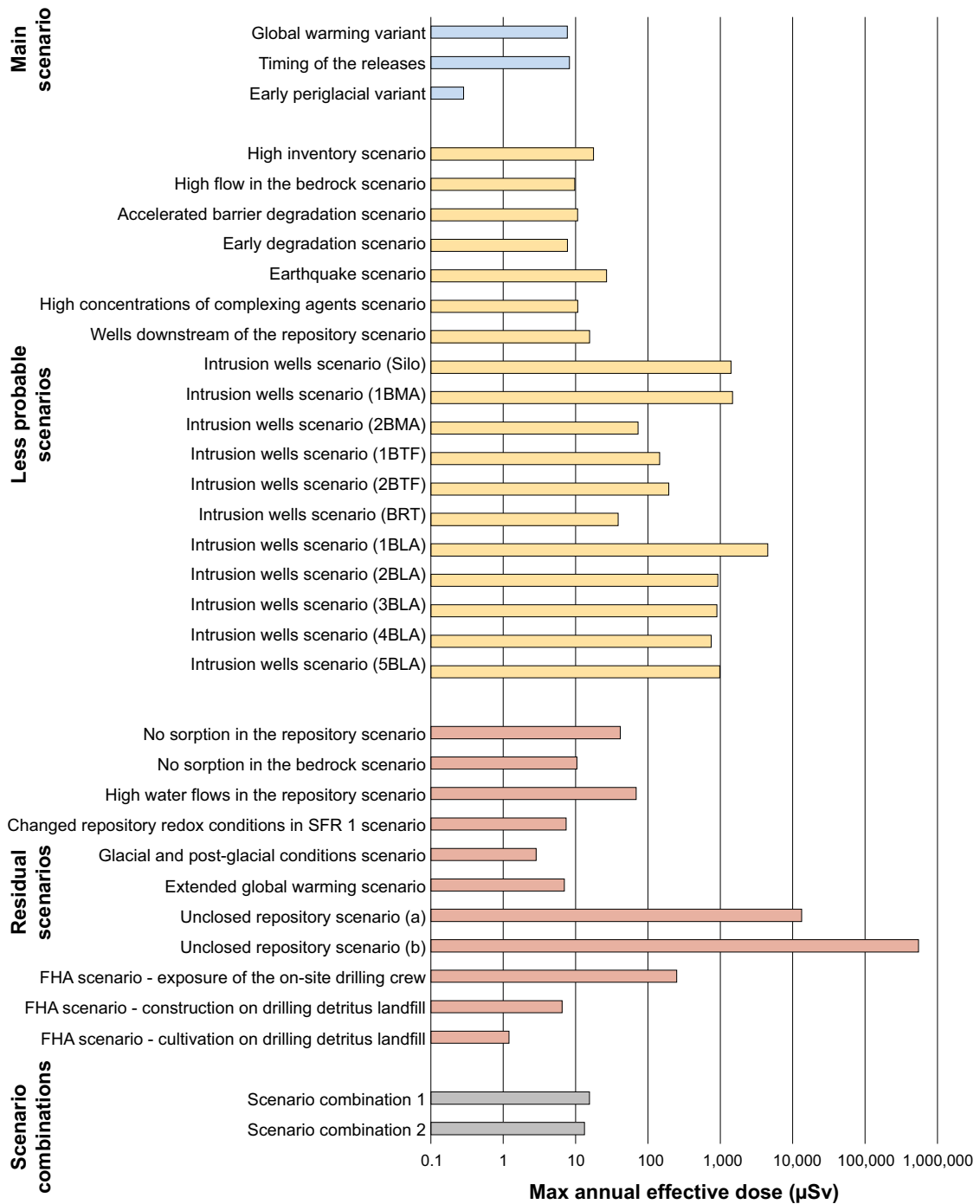
(c) 100 years after the unclosed repository is abandoned.

## 9.7 Dose rates to non-human biota

Exposure to non-human biota (NHB) has been estimated by calculating absorbed dose rates (below denoted ‘dose rates’) for a number of calculation cases and biosphere scenarios (see the **Biosphere synthesis report** Table 7-4). All the estimated dose rates are well below the proposed screening value of 10 μGy h<sup>-1</sup> (Beresford et al. 2007, Brown et al. 2008) and also well below the more limiting DCRLs for vertebrates proposed by ICRP (ICRP 2014), and thus it can be concluded that the repository will not affect biodiversity or sustainable use of biological resources in the Forsmark area. Key results for the *global warming variant of the main scenario* are presented, with an overview of maximum dose rates across the other scenarios, in this section. An in-depth analysis of the *global warming variant of the main scenario*, as well as details of other scenarios can be found in the **Radionuclide transport report**.

The Swedish Radiation Safety Authority, in its guidelines for assessments of impacts of nuclear fuel and waste on the environment (SSMFS 2008:37), states that reports should be based upon knowledge of the ecosystem concerned. The present assessment is based, wherever possible, upon site-specific parameter values that were collected in a site-characterisation survey. Thus a deterministic assessment was performed, based upon these specific values, rather than undertaking a probabilistic assessment using parameter sets sampled from parameter probability density functions. All results presented in this section are from deterministic calculations, which have been supported by probabilistic calculations in order to investigate the uncertainties in the deterministic results (see the **Radionuclide transport report**).

With the exception of the *early periglacial variant of the main scenario*, all maximum dose rates were found in biosphere object 157\_2 and so only data from this object have been included in this section; details of exposures to non-human biota in other biosphere objects can be found in the **Radionuclide transport report**. In the *early periglacial variant of the main scenario*, biosphere object 157\_2 is frozen and does not receive groundwater from the repository; maximum dose rates occurred in the secondary biosphere object 157\_1 (freshwater and terrestrial ecosystems only). A summary of the maximum dose rates across all scenarios is presented in Section 9.7.2 below (see also Table 9-22).



**Figure 9-45.** Peak annual effective doses for the main scenarios, the less probable scenarios (to be multiplied by the probability of the scenario in the risk assessment) and the residual scenarios (identified to study the function of individual barriers and assess unlikely scenarios) presented in this chapter. For the unclosed repository scenario peak doses are given for cases addressing the two different inventories: (a) the inventory to be disposed in SFR and (b) the inventory to be disposed in SFR plus the inventory to be temporarily stored (and to be disposed in SFL).

**Table 9-22. Summary of information relating to the maximum dose rates found in non-human biota in the Main scenario, Less probable scenarios, Residual scenarios and Combination scenarios. For each scenario, data for the relevant ecosystems (MA = Marine; FW = Freshwater; TE = Terrestrial) in primary source object 157\_2 (unless specified) are given.**

Scenario	Ecosystem	Organism type	Time (year AD)	Maximum dose rate ( $\mu\text{Gy/h}$ )	Percentage internal dose rate (%)	Key radionuclide (contribution to dose rate)
<b>Main scenario</b>						
Global warming variant	MA	(Wading) bird	4250	5.2E-3	100	C-14 (org) (98%)
	FW	Bird	4500	7.1E-3	100	C-14 (org) (98%)
	TE	Lichen & bryophytes	7000	3.3E-3	100	U-238 (66%)
Early periglacial variant (Object 157_1)	MA					
	FW	Zooplankton	17,850	2.7E-3	100	Pa-231 (81%)
	TE	Detritivorous invert.	17,850	1.4E-3	98	Pa-231 (79%)
Timing of the release variant	MA	(Wading) bird	4250	5.2E-3	100	C-14 (org) (98%)
	FW	Bird	4300	7.0E-3	100	C-14 (org) (98%)
	TE	Lichen & bryophytes	7400	2.7E-3	100	U-238 (66%)
<b>Less probable scenarios</b>						
High inventory scenario	MA	(Wading) bird	4250	6.5E-3	100	C-14 (org) (93%)
	FW	Zooplankton	8400	2.9E-2	100	Se-79 (65%)
	TE	Detritivorous invert.	5250	9.0E-3	68	Pa-231 (43%)
High flow in the bedrock scenario	MA	(Wading) bird	4250	6.2E-3	100	C-14 (org) (97%)
	FW	Bird	4350	8.5E-3	100	C-14 (org) (97%)
	TE	Lichen & bryophytes	6300	4.1E-3	99	U-238 (66%)
Accelerated concrete degradation scenario	MA	(Wading) bird	4250	7.0E-3	100	C-14 (org) (92%)
	FW	Bird	4350	9.6E-3	100	C-14 (org) (92%)
	TE	Lichen & bryophytes	6950	3.3E-3	100	U-238 (66%)
Bentonite degradation scenario	MA	(Wading) bird	4250	5.2E-3	100	C-14 (org) (98%)
	FW	Bird	4500	7.1E-3	100	C-14 (org) (98%)
	TE	Lichen & bryophytes	7000	3.3E-3	100	U-238 (66%)
Earthquake scenario	MA	(Wading) bird	4250	6.9E-2		
	FW	Bird	4350	9.2E-2		
	TE	Bird Egg	4350	6.4E-3		
High concentrations of complexing agents scenario	MA	(Wading) bird	4250	5.5E-3	100	C-14 (org) (98%)
	FW	Bird	4350	7.4E-3	100	C-14 (org) (98%)
	TE	Lichen & bryophytes	7050	3.4E-3	100	Pa-231 (66%)
<b>Residual scenarios</b>						
Loss of barrier function scenario – no sorption in the repository	MA	(Wading) bird	4250	4.6E-2	100	C-14 (inorg) (89%)
	FW	Bird	4300	6.2E-2	100	C-14 (inorg) (89%)
	TE	Bird Egg	4650	3.9E-3	98	C-14 (inorg) (53%)
Loss of barrier function scenario – no sorption in the bedrock	MA	(Wading) bird	4250	5.2E-3	100	C-14 (org) (98%)
	FW	Zooplankton	6150	2.1E-2	100	Pa-231 (78%)
	TE	Lichen & bryophytes	5350	1.5E-2	100	U-238 (60%)
Loss of barrier function scenario – high water flows in the repository	MA	(Wading) bird	4250	2.0E-2	100	C-14 (inorg) (92%)
	FW	Vascular plant	31,500	3.2E-2	100	Pu-239 (73%)
	TE	Bird Egg	4200	5.7E-3	93	I-129 (64%)
Changed repository redox conditions in SFR 1 scenario	MA	(Wading) bird	4250	5.1E-3	100	C-14 (org) (100%)
	FW	Vascular plant	52,000	1.7E-2	100	Pu-239 (92%)
	TE	Lichen & bryophytes	7050	3.3E-3	100	U-238 (66%)
Extended global warming scenario	MA	(Wading) bird	5250	5.4E-3	100	C-14 (org) (98%)
	FW	Bird	5300	6.4E-3	100	C-14 (org) (98%)
	TE	Lichen & bryophytes	6600	1.7E-3	100	U-238 (65%)
<b>Scenario combinations</b>						
Scenario combination 1	MA	(Wading) bird	4250	8.6E-3	100	C-14 (org) (82%)
	FW	Bird	4300	1.1E-2	100	C-14 (org) (82%)
	TE	Lichen & bryophytes	6250	4.2E-3	99	U-238 (65%)
Scenario combination 2	MA	(Wading) bird	4250	6.3E-3	100	C-14 (org) (97%)
	FW	Zooplankton	37,000	9.1E-3	100	Ni-59 (90%)
	TE	Lichen & bryophytes	6300	4.2E-3	99	U-238 (65%)

### 9.7.1 Global warming variant of the main scenario

In the *global warming variant* of the main scenario, the radionuclide release from the repository begins 1,000 years after repository closure. Radionuclides will start reaching the biosphere shortly after. At that time, part of the main recipient object (157\_2) is evolving from a marine bay into a mire, therefore exposure to marine and terrestrial (wetland) organisms have been estimated. The object has no defined freshwater stage, but since surface water in mire areas is an important habitat for water-dwelling organisms, radiation exposures to freshwater organisms have been estimated from radionuclide concentrations in the upper peat and corresponding pore water.

The dose rates are all well below the screening value of  $10 \mu\text{Gy}\cdot\text{h}^{-1}$  and also well below the DCRLs for invertebrates suggested by ICRP (ICRP 2014); thus, no impacts on populations of NHB are expected in the *global warming variant of the main scenario*.

#### Marine ecosystem

Since the simulated objects are marine areas only during the initial time period, the simulated period for marine ecosystems was short compared with that for freshwater and terrestrial ecosystems (see sections below) and the exposure pattern seen for those (initial peak followed by a somewhat more stable long-term phase) was not evident for the marine environments. Instead, only the initial stages of what is described as the peak phase (in terrestrial and freshwater ecosystems) can be seen in the simulation period. Marine organisms received dose rates more than three orders of magnitude lower than the screening dose rate (Figure 9-46), with the highest dose rate occurring in the (Wading) bird at  $5.2 \cdot 10^{-3} \mu\text{Gy}\cdot\text{h}^{-1}$  (Table 9-22). The total dose rates for all organism types, except Phytoplankton, followed each other closely and the difference between most and least exposed was approximately one order of magnitude. Phytoplankton received the lowest exposure during the whole simulation period (Figure 9-46). The gap between the dose rate for Phytoplankton and the others decreases in the course of simulated time, but was still about two orders of magnitude at the end of the period.

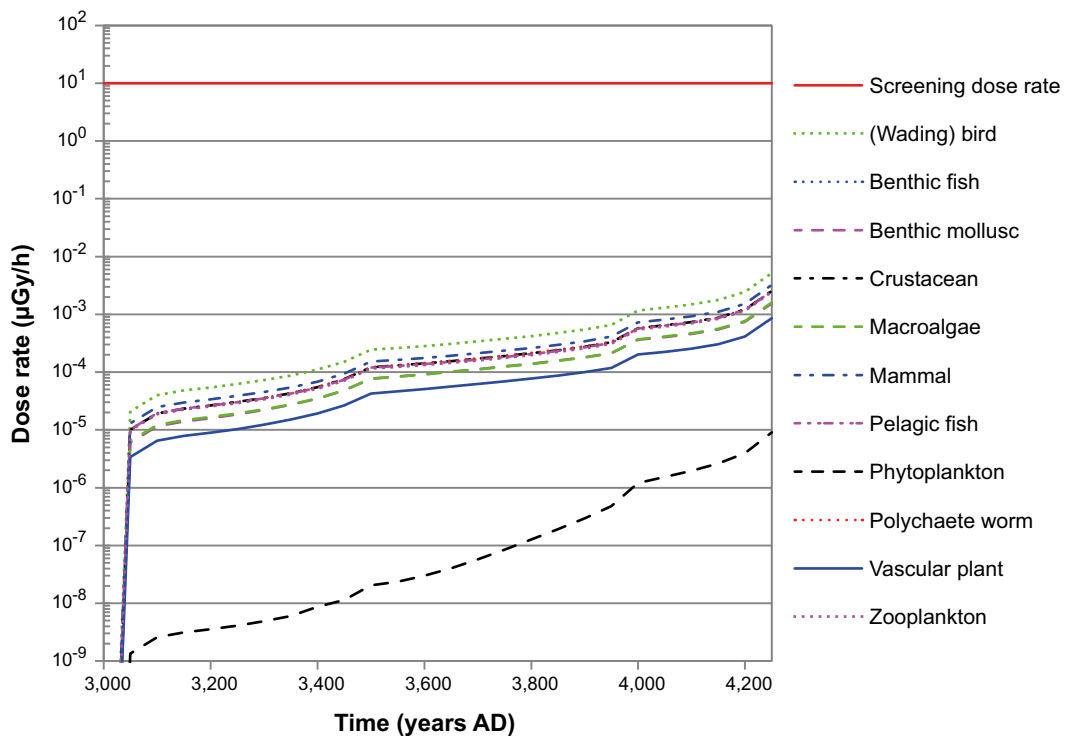


Figure 9-46. Dose rates to non-human biota in the marine ecosystem for the *global warming variant of the main scenario*.

The much lower total dose rate to Phytoplankton, compared with other organisms, was due to the very small size of the organism and the high proportion of internal beta/gamma emitting radionuclides; thus a larger proportion of the beta/gamma emission from internal sources can escape from Phytoplankton without interacting with the organism. In this assessment, the dose rates to the organisms, including Phytoplankton, are calculated to an individual; cross-exposure of phytoplankton, which forms large blooms of millions of individuals, would likely occur whereby the beta radiation from one organism would result in the irradiation of a neighbouring individual. Therefore, the exposure in phytoplankton is likely to be somewhat greater, depending on the density of the bloom, than the value reported for phytoplankton here, but less than that of an equivalent multicellular organism (i.e. Vascular plant, or Macroalgae). The dose rate reported for Phytoplankton, in the present assessment, can be considered a minimum value for the exposure, and a theoretical maximum (as if phytoplankton individuals were as dense as physically possible) would be that of Vascular plant in the same environment; the impact of such variation, for assessment purposes would be negligible and thus is not tested further.

### Freshwater ecosystem

The highest total dose rate seen in any freshwater organism was  $7.1 \cdot 10^{-3} \mu\text{Gy} \cdot \text{h}^{-1}$  (Bird), more than three orders of magnitude lower than the screening dose rate (Table 9-22 and Figure 9-47) and also well below the more limiting screening dose rates for invertebrates suggested by ICRP (ICRP 2014). However, in this particular organism, the maximum dose rate was only achieved at the very beginning, due almost entirely to C-14 (Table 9-22); immediately after, dose rates to this organism decreased rapidly, and by the end of the assessment period it was one of the least exposed organisms. For almost the entirety of the period, Zooplankton was the most exposed organism, with dose rates of the order of  $10^{-3} \mu\text{Gy} \cdot \text{h}^{-1}$  (Figure 9-47). For many organisms, a peak was seen around 7000 AD. After the peak had subsided, the least exposed organisms were the Pelagic fish, Benthic fish, and Bird, which ended with dose rates two orders of magnitude lower than those of Zooplankton.

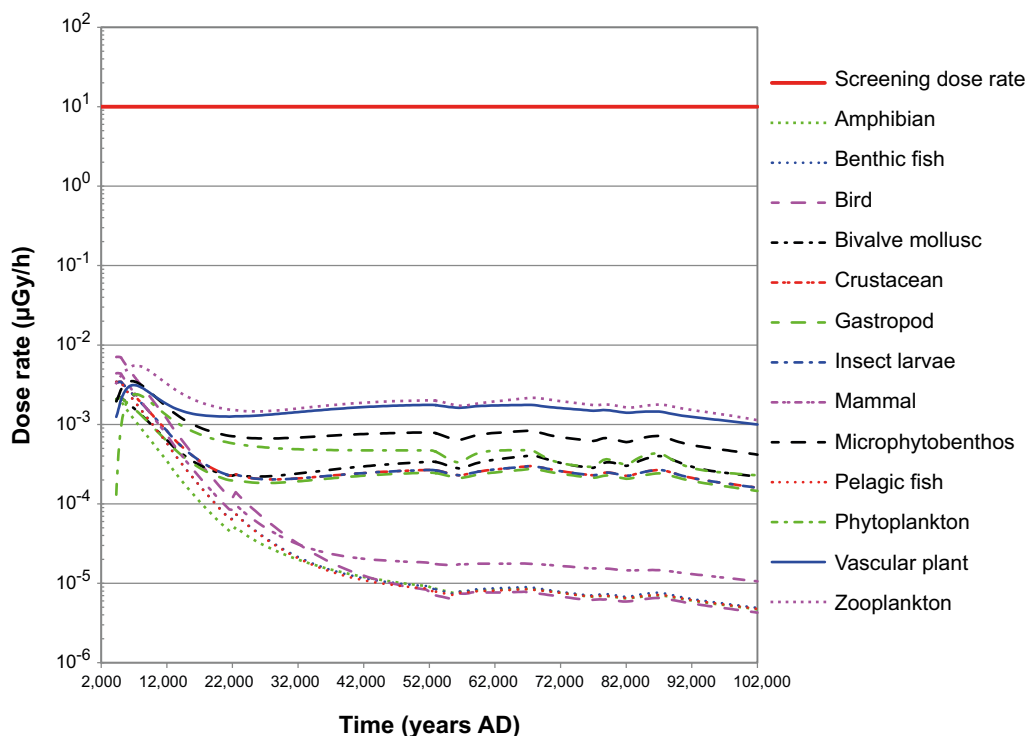


Figure 9-47. Dose rates to non-human biota in the freshwater ecosystem for the global warming variant of the main scenario.

## Terrestrial ecosystem

The highest total dose rate seen in any terrestrial organism was  $3.3 \cdot 10^{-3} \mu\text{Gy} \cdot \text{h}^{-1}$  (Lichen & bryophytes), more than three orders of magnitude lower than the screening dose rate (Table 9-22 and Figure 9-48) and also well below the more limiting screening dose rates for invertebrates suggested by ICRP (ICRP 2014). The lowest dose rates were one further order of magnitude lower than the screening dose rate, approximately. A peak at  $\sim 7000$  AD was seen, similar to that observed in the freshwater environment. The most exposed organisms in the long-term phase were Lichen & bryophytes and Detritivorous invertebrate. Distinct troughs (temporary decreases) in dose rate were observed at several points during the assessment period, due to permafrost during periglacial periods where groundwater freezes, temporarily eliminating the transfer of radionuclides through the geosphere.

### 9.7.2 Overview of NHB assessment results across all scenarios

A summary of the maximum dose rates in each ecosystem, across all scenarios, is shown in Table 9-22. All calculations resulted in dose rates lower than the screening dose rate by two orders of magnitude or more, indicating that no radiological impacts on NHB are expected from the repository. The maximum dose rate calculated was in freshwater Bird in the *earthquake scenario* at 4350 AD. Dose rates of the same order of magnitude ( $10^{-2} \mu\text{Gy} \cdot \text{h}^{-1}$ ) were found in seven scenarios: *high inventory scenario*, *earthquake scenario*, *loss of barrier function scenario – no sorption in the repository*, *loss of barrier function scenario – no sorption in the bedrock*, *loss of barrier function scenario – high water flow in the repository*, *changed repository redox conditions in SFR 1 scenario*, and the *scenario combination 1*. The highest dose rates in each scenario were found in the freshwater ecosystem.

In the marine ecosystem, dose rates in organisms increased rapidly before beginning to level off; the short duration of the marine ecosystem in the context of the whole assessment period meant that dose rates to organisms did not reach a stationary state, and continued to increase until the point in time where the sea withdrew completely from the object ( $\sim 4250$  AD in most scenarios). The maximum dose rates in marine organisms were thus found at the end of the marine assessment period.

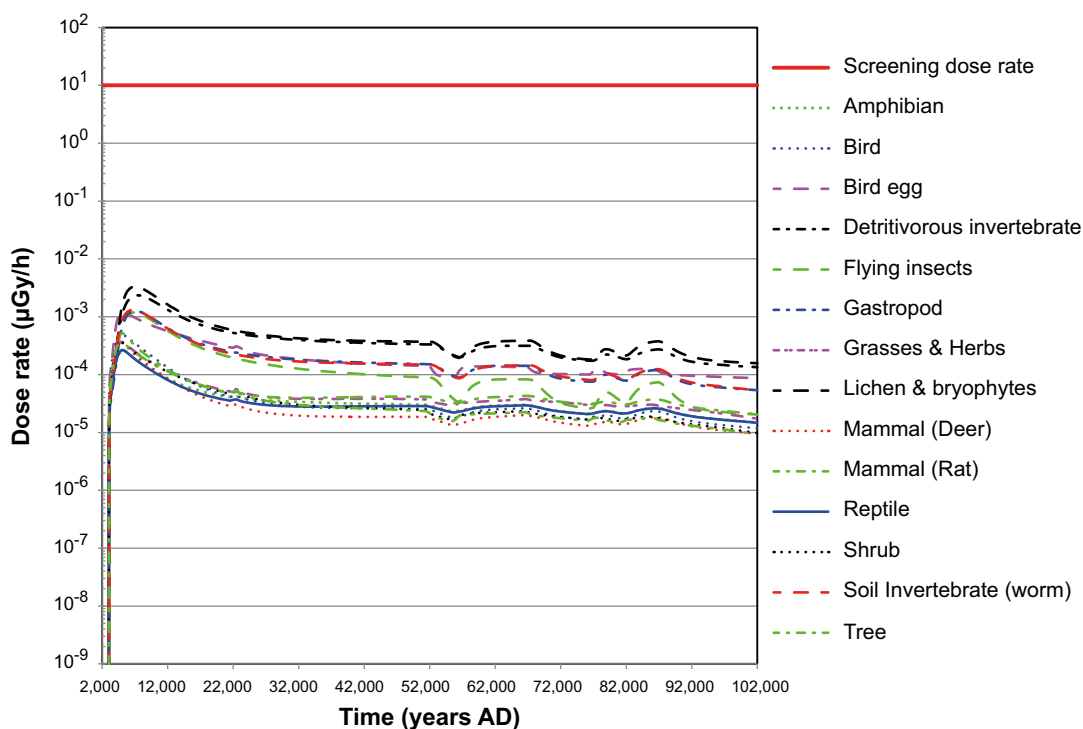


Figure 9-48. Dose rates to non-human biota in the terrestrial ecosystem for the *global warming variant of the main scenario*.

In freshwater and terrestrial ecosystems, for most organisms, results in most scenarios followed the pattern of the *global warming variant of the main scenario*: with a well-defined peak either immediately at the beginning, or after just a few thousand years, before decreasing gradually over the rest of the assessment period. However, where Vascular plant was the most exposed freshwater organism type, the peak was less pronounced (in the *changed repository redox conditions in SFR 1 scenario*) or non-existent (in the *loss of barrier function scenario – high water flow in the repository*), and instead of decreasing after the peak, dose rates continued to increase until ~30,000–50,000 AD; the maximum dose rates for Vascular plant were thus found later in the assessment period. In scenarios where Zooplankton was the most exposed freshwater organism type the dose rate pattern included a significant peak in the *loss of barrier function scenario – no sorption in the bedrock and high inventory scenario*, in the remaining cases (*early periglacial variant*, and the *scenario combination 2*) the dose rates increased for longer, with the highest dose rate occurring later.

Internal sources of radiation dominated the dose rates to the most exposed organisms in all scenarios (Table 9-22). No trend was seen with regards to habitat (in/on water vs. in/on sediment; in air vs. in/on soil), due to the largely internal exposure. If dose rates were more affected by external sources, higher doses in soil/sediment habitats than in water/air would be expected.

C-14-org dominated the dose rate to the most exposed marine organisms in all but two scenarios where C-14-inorg was dominant instead (Table 9-22). C-14 was a key radionuclide also in the freshwater ecosystem in most scenarios, but in some scenarios other radionuclides were dominant (Pa-231, Pu-239, Se-79 and Ni-59, see Table 9-22). In the terrestrial ecosystem, U-238 was the key radionuclide in most scenarios, with the exception of a few scenarios where dose rates to the most exposed organism was dominated by Pa-231, C-14-org, or I-129 (Table 9-22).



## 10 Assessment of risk

This chapter presents the results of the safety assessment with the aim of demonstrating that the existing repository and the extension will provide adequate long-term protection for human health and the environment. This is done by showing that the repository meets the relevant regulatory criteria and requirements defined in the regulations SSMFS 2008:21 and 2008:37 for the assessment time-period.

The assessment time period depends on the half-lives of the radionuclides in the waste. At closure, the activity in the repository is dominated by short-lived radionuclides<sup>9</sup>. However, as these short-lived radionuclides decay, the relative contribution of long-lived radionuclides to the total activity in the repository increases. During the assessment time period, the repository system changes. Based on the reference evolution (Chapter 6), three distinct periods have been deemed suitable for analysis and reporting the results of the assessment.

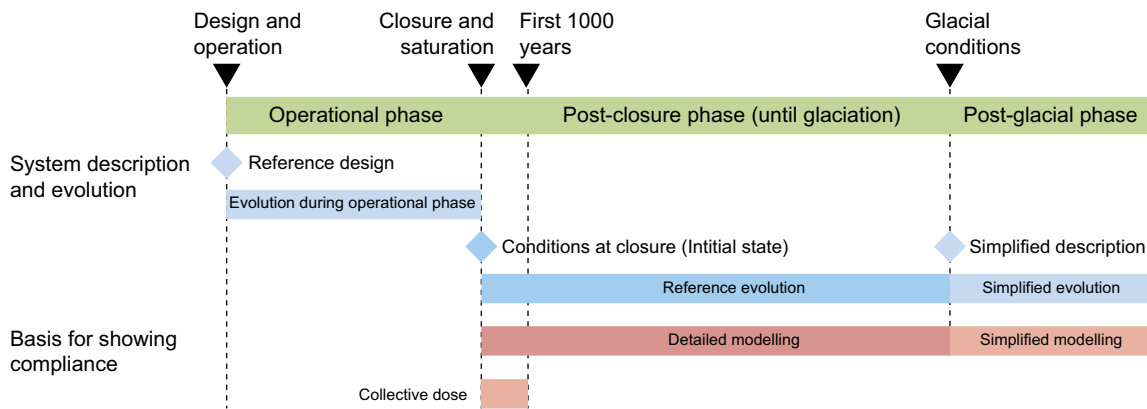
- First 1,000 years after repository closure when the repository is below the sea. During this time period, the low hydraulic gradient in the bedrock ensures close to stagnant hydraulic conditions and a low water flow through the repository. During this period, short-lived radionuclides will decay substantially (less than  $10^{-9}$  of the initial inventory remains after 1,000 years). Also some long-lived radionuclides, like Ni-63 with a half-life of 100 years, will decay substantially during this time period ( $10^{-3}$  of the initial inventory of Ni-63 will remain after 1,000 years). During this time period, the evolution of the repository system is described by the reference evolution which starts from the initial state as described in Chapter 4.
- Periods of temperate and periglacial climate domains. During this time period, which is at least 50,000 years long, the shoreline passes over the repository and the hydraulic gradient increases. The inventories of Am-241, C-14 and Mo-93 will decay substantially (their half-lives being 432, 5,730 and 4,000 years, respectively) and the repository system will evolve as described by the reference evolution.
- Periods of glacial and post-glacial conditions. Beyond 50,000 years only long-lived radionuclides such as Ni-59, Cl-36, U-238 and its progeny remain. During this time period for which the evolution of the repository system is more uncertain, a simplified model for the evolution is used as described the *glaciation and post-glacial conditions scenario*.

Figure 10-1 indicates how the repository system evolves, how this is described in the assessment and the basis for the risk evaluation. During the operational phase, the description of the repository system and components therein is initially based on the reference design. The operational phase is not covered in the post-closure safety assessment, but it is necessary to estimate the evolution of the repository system during this phase in order to describe the system after closure and saturation (the initial state).

The evolution of the repository system from closure until glaciation is based on the initial state and described by the reference evolution. For the time after a glaciation, a simplified evolution is used. In addition to individual doses and risks, two measures of collective dose are calculated: 1) for the global population due to releases of C-14 to the atmosphere, and 2) to the population around the Baltic Sea due to releases to the Baltic Sea and subsequent intake of radionuclides in fish.

---

<sup>9</sup> Short-lived waste is defined according to the IAEA Safety Glossary, 2007 Edition (IAEA 2007) as “radioactive waste that does not contain significant levels of radionuclides with half-lives greater than 30 years”. SKB uses the same definition but with 31 years to include cesium-137, which is used as a key radionuclide to estimate the content of other radionuclides. Waste that is not short-lived is consequently considered long-lived.



**Figure 10-1.** Time scales of importance for the evaluation of the repository system and for estimating radiological risk. In order to describe the condition after closure, the evolution of the repository system during the operational phase must be evaluated. The reference evolution is based on the initial state. For post-glacial conditions a simplified description of the repository system is needed, see further Section 2.3.1.

## 10.1 Regulatory requirement

The regulatory authority, the Swedish Radiation Safety Authority (SSM), issues regulations (and associated general advice on the application of the regulations) with which the licensee of a nuclear facility must demonstrate compliance. Of importance for the safety assessment is SSMFS 2008:37 that among other matters states that:

*Human health and the environment shall be protected from detrimental effects of ionising radiation during the period of time when the various stages of the final management of spent nuclear fuel and nuclear waste are being implemented as well as in the future. The final management may not cause impacts on human health and the environment outside Sweden's borders that are more severe than those accepted inside Sweden.*

In the following sections, additional regulatory requirements and criteria for protection of human health (Section 10.1.1) and the environment (Section 10.1.2) that are of importance for the analysis of the long-term safety of SFR are reproduced.

### 10.1.1 Protection of human health

SSM's regulations SSMFS 2008:37 and associated general advice state that:

*A repository for spent nuclear fuel or nuclear waste shall be designed so that the annual risk of harmful effects after closure does not exceed  $10^{-6}$  for a representative individual in the group exposed to the greatest risk.*

Risk is defined as:

*The product of the probability of receiving a radiation dose and the harmful effects of the radiation dose.*

Harmful effects are defined as:

*Cancer (fatal and non-fatal) as well as hereditary effects in humans caused by ionising radiation, in accordance with paragraphs 47–51 in Publication 60, 1990, of the International Commission on Radiological Protection.*

*Under the regulations, the recommendations of the International Commission on Radiological Protection (ICRP) are to be used for calculation of the harmful effects of a radiation dose. According to ICRP publication no. 60, 1990, the factor for conversion of effective dose to risk is 7.3 percent per sievert.*

The associated general advice to SSM 2008:37 states:

*One way of defining the most exposed group is to include the individuals who receive a risk in the interval from the highest risk down to one-tenth of this risk. If a larger number of individuals can be considered to be included in such a group, the arithmetic average of individual risks in the group should be used for demonstrating compliance with the criterion for individual risk contained in the regulations. One example of this kind of exposure situation is a release of radioactive substances into a large lake that can be used as a source of drinking water and for fishing.*

*If the exposed group only consists of a few individuals, the criterion of the regulations for individual risk can be considered as being complied with if the highest calculated individual risk does not exceed  $10^{-5}$  per year. An example of a situation of this kind might be if consumption of drinking water from a drilled well is the dominant exposure path. In such a calculation example, the choice of individuals with the highest risk load should be justified by information about the spread in calculated individual risks with respect to assumed living habits and places of stay.*

*The individual risk should be calculated as an annual average on the basis of an estimate of the lifetime risk for all relevant exposure pathways for every individual. The lifetime risk can be calculated as the accumulated lifetime dose multiplied by the conversion factor of 7.3 per cent per sievert.*

A probabilistic analysis can in certain cases:

*...give an insufficient picture of how an individual detrimental event, for instance a major earthquake, would affect the risk for a particular generation.*

In these cases the probabilistic calculations should be:

*...supplemented by calculating the risk for the individuals who are assumed to live after the event has taken place and who are affected by its calculated maximum consequence. The calculations can for instance be made by illustrating the significance of an event occurring at different points in time ( $T_1, T_2 [\dots], T_n$ ), taking into consideration the probability of the event occurring during the respective time interval ( $T_0$  to  $T_1, T_0$  to  $T_2 [\dots], T_0$  to  $T_n$ , where  $T_0$  corresponds to the time of closure of the repository).*

### **10.1.2 Protection of the environment**

Regarding protection of the environment, the following requirement is included in SSMFS 2008:37: *The final management of spent nuclear fuel and nuclear waste shall be implemented so that biodiversity and the sustainable use of biological resources are protected against the harmful effects of ionising radiation.*

Quantitative risk criteria for protection of the environment are, however, lacking in the applicable Swedish regulations.

## **10.2 Protection of human health, collective dose**

Collective doses resulting from releases during the first 1,000 years after closure of the repository has been calculated for two populations using the geosphere releases obtained in the *timing of the releases calculation case*, see Section 9.2.3. The collective dose to the global population due to C-14 releases to the atmosphere was calculated to 2.5 man Sv. This collective dose corresponds to a maximum average per capita effective dose (collective dose divided by the number of individuals in the group) of 0.25 nSv<sup>10</sup>.

The collective dose to the Baltic population due to radionuclide releases to the Baltic Sea and subsequent exposure of the population by ingestion of fish was calculated to 0.15 man Sv<sup>11</sup>. The dose to the Baltic population was also dominated by C-14.

---

<sup>10</sup> As comparison, if the present practice of nuclear power production were to be limited to 100 years at the present capacity, the maximum annual per capita effective dose to the global population due to globally dispersed radionuclides would be less than 200 nSv (UNSCEAR 2010, Annex B, §415).

<sup>11</sup> As comparison, for the present world nuclear energy generation, the collective dose per year of practice is in the order of 200 man Sv (UNSCEAR 2010, Annex B, §415).

### 10.3 Protection of human health, periods of temperate and periglacial climate domains

The radiological risk for the main scenario was calculated by multiplying the arithmetic mean value of the annual dose, obtained at each time point from probabilistic calculations, by the conversion factor from dose to risk of 7.3 percent per Sievert. For the main scenario a probability of one was assumed. For the less probable scenarios, except for the *earthquake scenario*, the risk conditioned on the occurrence of the scenario was calculated in the same way as for the main scenario and it was then multiplied by the probability of the scenario, see Table 10-1 (scenarios and their corresponding probabilities are described in more detail in Chapter 7). The risk for the *earthquake scenario* was calculated by approximating the integral of risk described in equation 7-1 in SAR-08 (SKB 2008a) by the sum of the maximum dose at each time point from each earthquake calculation multiplied with the integrated probability that an earthquake event occurs before this time and the risk factor. It was assumed that the probability of the first earthquake occurring at a given time follows an exponential probability distribution. This approach is the same that was applied to calculate the risks from doses resulting from an earthquake in SAR-08 and is further described in (SKB 2008a).

**Table 10-1. Probabilities for less probable scenarios and scenario combinations.**

Scenario	Probability (P)
High inventory	< 0.05
High flow in the bedrock	< 0.1
Accelerated concrete degradation	< 0.1
Bentonite degradation	< 0.1
Earthquake	10 <sup>-6</sup> /year
High concentrations of complexing agents	< 0.1
Wells downstream of the repository	0.13
Intrusion wells	
Silo	2·10 <sup>-4</sup>
Each vault in SFR 1	8·10 <sup>-4</sup>
Each vault in SFR 3	3·10 <sup>-4</sup>
Scenario combination 1	< 0.1·0.1
Scenario combination 2	< 0.1·0.1

Combination of scenarios (Combination 1: *high flow in the bedrock calculation case* together with *accelerated concrete degradation calculation case* and Combination 2: *high flow in the bedrock calculation case* together with *high concentration of complexing agents calculation case*) are not included in the total risk or shown in the graphs due to their low probability (Table 10-1) and moderate dose contribution (Section 9.5) result in small contributions to the total risk. Maximum radiological risks from these two scenario combinations are shown in Table 10-2.

The estimated arithmetic mean value of the annual dose from the probabilistic calculations for the different scenarios, as presented in Chapter 9, provides the basis for the analysis of risks to humans. To estimate the total radiological risk, the different scenarios are combined as shown in Figure 10-2.

All less probable scenarios, except the *intrusion wells* and *wells downstream of the repository scenarios* are mutually exclusive with respect to the main scenario. Consequently, the risk of these less probable scenarios cannot be added to the risk from the main scenario, if the latter is calculated as described above, i.e. assuming a probability of occurrence of one. The combined radiological risk between the main scenario and these less probable scenarios is here calculated as the sum of the main and the less probable scenarios, weighted by their respective probabilities (given in Table 10-1) as shown below:

$$Risk_{combined} = Dose_{Max Main scenario} \left( 1 - P_{Less probable scenario} \right) \cdot 0,073 + P_{Less probable scenario} \cdot Dos_{Less probable scenario} \cdot 0,073 \quad (\text{Equation 10-1})$$

where  
*P* = probability

The *intrusion wells* and *wells downstream of the repository scenarios* and the main scenario are not mutually exclusive and the combined risk for the main scenario with these scenarios is calculated assuming a probability of one for the main scenario:

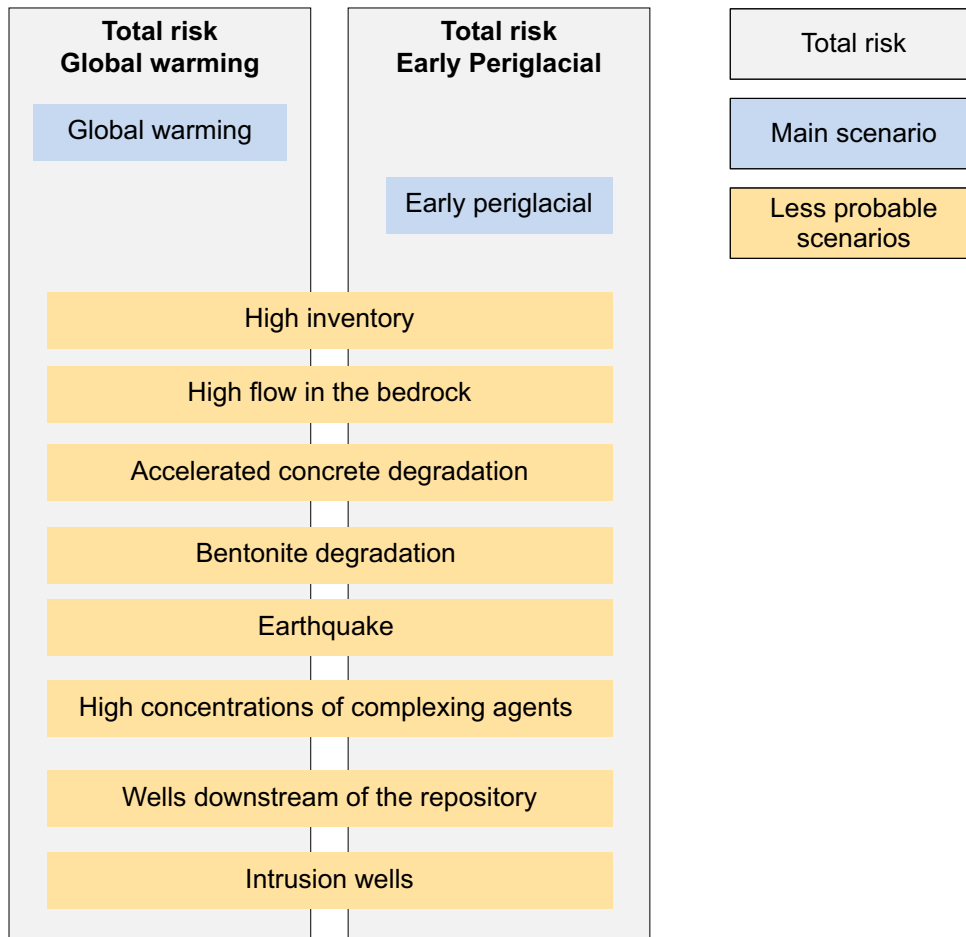
$$Risk_{combined, well} = Dose_{Max Main scenario} \cdot 0,073 + P_{Less probable scenario} \cdot Dose_{Less probable scenario} \cdot 0,073 \quad (\text{Equation 10-2})$$

The total risk is calculated as the sum of the risk for the main scenario (the variant that gives the highest risk) less the probabilities of the less probable scenarios (except wells) and the risk for the less probable scenarios, i.e. the total risk is calculated according to:

$$Risk_{Total} = Dose_{Max Main scenario} \cdot 0,073 \left(1 - \sum_x P_x\right) + \sum_x Dose_x \cdot 0,073 \cdot P_x + \sum_i Dose_i \cdot 0,073 \cdot P_i \quad (\text{Equation 10-3})$$

where

$x = \{High inventory, High flow in the bedrock, Accelerated concrete degradation, Bentonite degradation, Earthquake, High concentrations of complexing agents\}$ ,  
 $i = \{Wells downstream the repository, Intrusion wells\}$ .



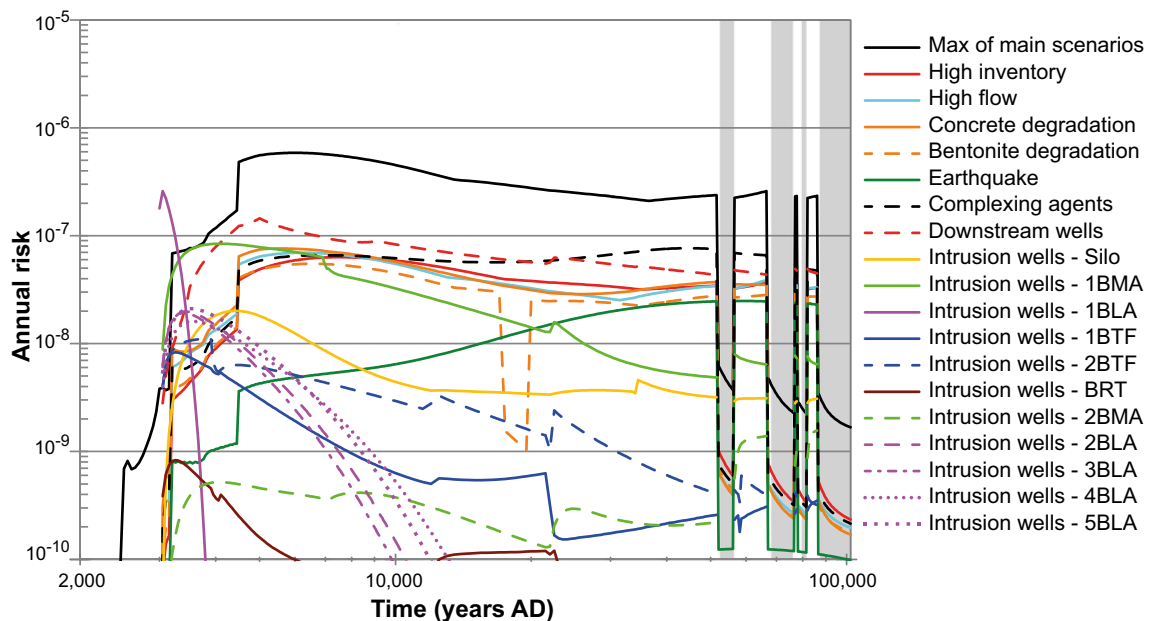
**Figure 10-2.** Combination of scenarios for the calculation of total risk..

### 10.3.1 Radiological risk for the main scenario and each of the less probable scenarios

The estimated radiological risks for the main scenario and the less probable scenarios are presented in Figure 10-3, where ‘Max of main scenarios’ represents the maximum, at each time, of the *global warming variant* and the *early periglacial variant of the main scenario*. However, it can be noted that the maximum, at each time, is given by the *global warming variant* (see Section 9.2.1). As can be seen in Figure 10-3, the highest radiological risk is generally obtained for the main scenario. An exception is for a short period around 3000 AD when the highest risk is obtained for the *intrusion wells scenario* for 1BLA.

For most scenarios, the radiological risks increase initially with time and then decrease or remain nearly constant during the rest of the assessment period. However, the radiological risks for the *earthquake scenario* and the *intrusion wells scenario* for 2BMA show a different time variation. For the *earthquake scenario*, an increasing trend with time is observed, which is explained by the increasing cumulative probability that an earthquake event will occur before a given time point, whereas the maximum dose values remain nearly constant during the whole assessment period.

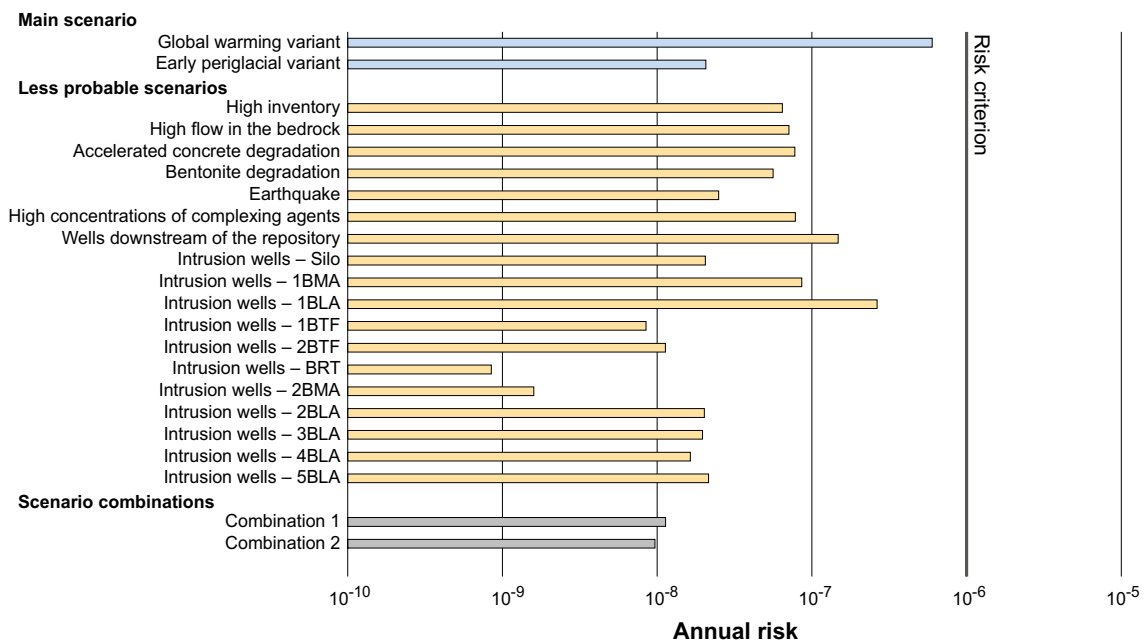
The maximum annual radiological risk for each scenario is presented in Table 10-2 and in Figure 10-4. The highest maximum annual radiological risk ( $6.0 \cdot 10^{-7}$ ) is obtained for the main scenario. The second highest radiological risk ( $2.6 \cdot 10^{-7}$ ) is obtained for *intrusion wells scenario* for 1BLA. The maximum radiological risk for each of the other scenarios is generally one or more orders of magnitude lower than that for the main scenario.



**Figure 10-3.** Radiological risk for each scenario using probabilities from Table 10-1 and calculated annual effective doses as presented in Chapter 9. Max of main scenarios represents the maximum, at each time, of the *global warming variant* and the *early periglacial variant of the main scenario*. The unshaded areas correspond to temperate climatic conditions and the grey shaded areas to periglacial conditions with continuous permafrost.

**Table 10-2. Maximum annual radiological risks to humans obtained for each of the main and less probable scenarios. The year at which the maximum radiological risks are obtained is also indicated. The maximum radiological risk is given for both the *global warming variant* and the *early periglacial variant of the main scenario*.**

Scenario	Maximum radiological risk	Year of maximum risk [AD]
<b>Main scenario</b>		
Global warming variant	$6.0 \cdot 10^{-7}$	6000
Early periglacial variant	$1.2 \cdot 10^{-8}$	17,800
<b>Less probable scenarios</b>		
High inventory	$6.5 \cdot 10^{-8}$	7500
High flow in the bedrock	$7.1 \cdot 10^{-8}$	6250
Accelerated concrete degradation	$7.8 \cdot 10^{-8}$	5550
Bentonite degradation	$5.6 \cdot 10^{-8}$	6500
Earthquake	$2.5 \cdot 10^{-8}$	58,500
High concentrations of complexing agents	$7.8 \cdot 10^{-8}$	44,500
Wells downstream of the repository	$1.5 \cdot 10^{-7}$	5000
Intrusion wells – Silo	$2.1 \cdot 10^{-8}$	4450
Intrusion wells – 1BMA	$8.6 \cdot 10^{-8}$	4100
Intrusion wells – 1BLA	$2.6 \cdot 10^{-7}$	3050
Intrusion wells – 1BTF	$8.5 \cdot 10^{-9}$	3250
Intrusion wells – 2BTF	$1.1 \cdot 10^{-8}$	3850
Intrusion wells – BRT	$8.5 \cdot 10^{-10}$	3250
Intrusion wells – 2BMA	$1.6 \cdot 10^{-9}$	86,000
Intrusion wells – 2BLA	$2.0 \cdot 10^{-8}$	3450
Intrusion wells – 3BLA	$2.0 \cdot 10^{-8}$	3400
Intrusion wells – 4BLA	$1.6 \cdot 10^{-8}$	3550
Intrusion wells – 5BLA	$2.2 \cdot 10^{-8}$	3550
<b>Scenario combinations</b>		
Scenario combination 1	$1.1 \cdot 10^{-8}$	5700
Scenario combination 2	$9.7 \cdot 10^{-9}$	40,000



**Figure 10-4. Maximum radiological risk for the main and less probable scenarios as well as the scenario combinations.**

### 10.3.2 Radiological risks for scenario combinations

The radiological risks for combinations of the main scenario and each of the less probable scenarios are shown in Figure 10-5. The highest risk values are observed around 5000 AD. The combination of the main scenario and the *intrusion wells scenario* for 1BLA show a peak value at around 3000 AD. With the exception of this initial peak value, the other combinations of scenarios show approximately the same pattern in the risk variation with time. This is explained by the dominating contribution from the main scenario to the risk. The combination of the main scenario and the *wells downstream of the repository scenario* shows the highest radiological risk for most of the simulation period.

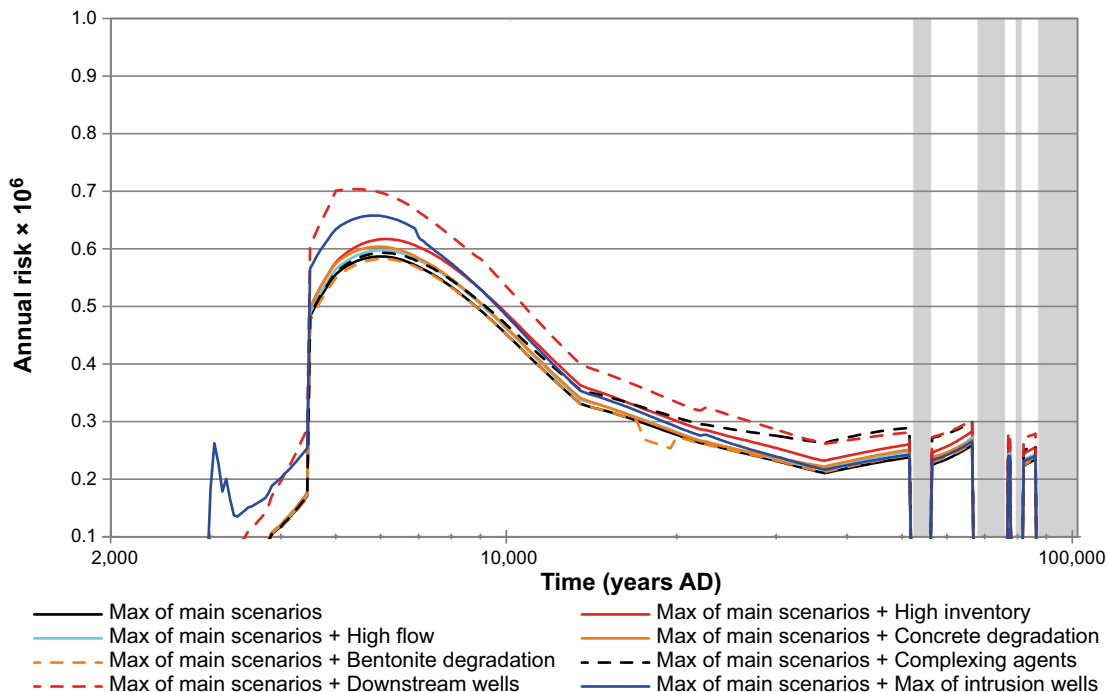
### 10.3.3 Total radiological risk

Figure 10-6 shows the total risk from the combination of the main scenario with all less probable scenarios. The maximum total risk  $9.0 \cdot 10^{-7}$  is obtained at 5000 AD. Thereafter, a weak decreasing trend is observed with the radiological risk remaining within the same order of magnitude, with exception of periods of periglacial conditions.

### 10.3.4 Compliance with the radiological risk criterion

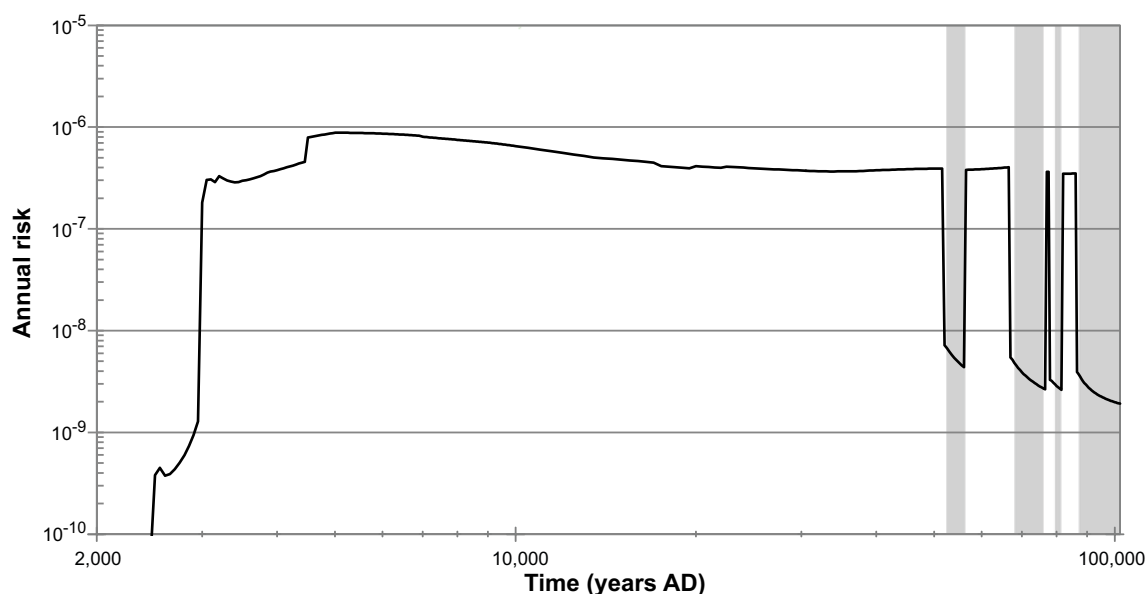
As shown in Section 10.3.1, the radiological risk for each of the main scenario and less probable scenarios is below the regulatory risk criterion of  $10^{-6}$  during the periods of temperate and periglacial climate domain. Also the radiological risk for combinations of the main scenario and each less probable scenario (see Section 10.3.2) is below the risk criterion.

Total radiological risk, i.e. the combination of the main scenario and all the less probable scenarios, is below the regulatory risk criterion of  $10^{-6}$  (see Section 10.3.3) and hence the repository complies with the radiological risk criterion during the periods of temperate and periglacial climate domain.



**Figure 10-5.** Radiological risks for combinations of the main scenario and each less probable scenario (according to equation 10-2). Max of main scenarios represents the maximum, at each time, of the global warming variant and the early periglacial variant of the main scenario. Max of intrusion wells represents the maximum, at each time, of intrusion wells in different repository vaults. The unshaded areas correspond to temperate climatic conditions and the grey shaded areas to periglacial conditions with continuous permafrost. Please note the scale on the y-axis, the risk has been multiplied by  $10^6$  in order to enhance readability, thus 0.1 and 1 on the axis correspond to annual risks of  $10^{-7}$  and  $10^{-6}$ , respectively.





**Figure 10-6.** Total radiological risk obtained from the combination of the maximum of the two main scenario variants and all less probable scenarios (according to equation 10-3). The white area indicates periods of temperate climatic conditions and the grey shaded area periglacial conditions with continuous permafrost.

### Assumptions in the assessment

When interpreting the risk estimate, it should be taken into consideration that a number of cautious assumptions have been made in the modelling of doses and associated radiological risks. Hence, the risk estimates that are presented should be seen as fit for the purpose in demonstrating compliance with the risk criterion; rather than as predictions of actual risks to individuals in the future. A description of pessimistic assumptions made in the assessment of doses is presented in the **Radionuclide transport report** and the **Biosphere synthesis report**. In Section 10.6, this is discussed in more detail.

A cautious assumption in the dose calculations that propagates into the risk estimates is that the entire radionuclide release takes place in a limited small area in the biosphere from which further transport takes place. The doses are calculated to an individual that takes all his or her food from the ecosystem that gives the highest dose, although, in reality, if current practice were to continue, humans would import a large proportion of their food from uncontaminated areas. In any case, the procedure for selection of the potentially most exposed group implies that this is a homogeneous group of no more than a few tens of people (see the **Biosphere synthesis report**). According to the Swedish regulations (see Section 10.1.1), when risks are estimated for such small groups, a higher risk criterion of  $10^{-5}$  can be used in demonstrating compliance with the requirement on protection of human health.

In addition to the cautious assumptions in the modelling, the procedure that was applied for combining scenarios for estimating the total risk is itself cautious. This relates, for example, to the combination of the main scenario with the *intrusion wells* and *wells downstream of the repository scenarios*. In the main scenario, doses to humans are, during periods when the biosphere objects are situated above the shoreline, calculated for water originating from a lake or stream, from a dug well or from a well drilled within the biosphere object adopting whichever of these has the maximum radionuclide concentrations. Clearly, adding the risks from utilising water within the biosphere object with utilising a well downstream of the repository and utilising intrusion wells into all repository vaults leads to an overestimate of the total risk since ingestion of drinking water is counted several times.

## 10.4 Protection of human health, glacial and post-glacial phase

In addition to the detailed modelling performed for temperate and periglacial climate conditions, reported in Section 10.3, radiological consequences in post-glacial conditions have been estimated in the *glaciation and post-glacial conditions scenario*. As discussed in Section 7.7.8, current scientific understanding suggests that the onset of the next glaciation will not occur in the next 50,000, or perhaps even the next 100,000, years. However, it cannot be ruled out that a glaciation will occur in Sweden during the latter part of the 100,000 year assessment period (see Section 3.5.1).

Since a glaciation is not likely to occur during the next 50,000 years, only very long-lived radionuclides will be of relevance when estimating the post-glacial radiological consequences. Therefore, the exact timing of the glacial event is of limited importance. As time progresses, the cumulative probability of a glacial event reaches one.

Due to the large uncertainties associated with the impact of a glaciation on the repository system, a detailed analysis of the evolution of the system under glacial and post-glacial conditions has not been performed. Rather, cautiously simplified assumptions with respect to the impact on the repository system of the glacial and post-glacial conditions have been made. The calculation is based on the ice-sheet development as described in the *Weichselian glacial cycle climate case (Climate report Section 4.4)*. A sequence, starting around 59,000 AD, of a period of glacial climate domain, followed by submerged conditions, and finally a temperate climate domain for the rest of the assessment period is assumed (see Section 7.7.8).

### 10.4.1 Annual dose

Results from dose calculations described in Section 9.4.8 show that the maximum estimated annual effective dose equals 2.8  $\mu\text{Sv}$  and is dominated by Ni-59. The maximum dose is thus below the annual effective dose that corresponds to the risk criterion of  $10^{-6}$ , i.e. 14  $\mu\text{Sv}$ .

The timing of the maximum dose, around 95,000 AD, is broadly determined by the sequence of climate domains assumed. Thus, the maximum dose would occur earlier or later if the assumptions regarding the timing of occurrence, or period of each climate domain were altered. However, since a glaciation is not likely to occur during the first 50,000 years after closure, only long-lived radionuclides remain in SFR. Therefore, the assumptions regarding the timing of the next period of glacial conditions are not expected to significantly influence the estimated maximum dose during postglacial conditions.

As discussed in Chapter 2, one of the safety principles for SFR is to *limit the amount of long-lived activity* in the repository. Although the protective capability of the repository will be severely degraded during a glaciation, the limited inventory of long-lived radionuclides ensures that the radionuclide fluxes are so low that estimated doses are below the limit corresponding to the risk criterion of  $10^{-6}$ .

## 10.5 Protection of the environment

The results obtained from all calculations of dose rates to non-human biota (NHB) were two orders of magnitude or more below the screening dose rate value of  $10 \mu\text{Gy}\cdot\text{h}^{-1}$  that has been recommended by Beresford et al. (2008) and Brown et al. (2008), and that has been adopted in this assessment as a criterion to judge protection of the environment. They were also well below the more restrictive screening dose rate for vertebrates given by the ICRP (ICRP 2014). In the assessment, a broad variety of NHB have been considered, including ICRP (ICRP 2003) reference animals and plants, ERICA reference organisms (Brown et al. 2008) and sensitive species representative of the site. The results indicate that no adverse impacts on NHB are expected from the repository under the selected scenarios. Hence, it can be concluded that the proposed solution for disposal of the waste in the SFR repository ensures that biodiversity and sustainable use of biological resources are protected against the harmful effects of ionising radiation.

## 10.6 Additional analysis

In the present section, an additional analysis of the estimated radiological risk is described. This is not a part of the compliance calculations, but is performed to describe how the rather complex system operates, to better target future Research, Development and Demonstration (RD&D) and to serve as a first step towards developing more detailed requirements on the repository system.

The relative contributions of individual waste vaults or radionuclides to the total risk from the repository depend on a number of factors, including: the radionuclide inventory and radiotoxicity of the wastes, the retention capacity of the different waste vaults and the behavior of radionuclides in the geosphere and biosphere. In addition, the relative estimates of the risks from different radionuclides or waste vaults are influenced by the degree of conservatism inherent in the assumptions made in the assessment, i.e. assumptions used to model different processes and when assigning values to model parameters. Hence, a ranking of the radionuclides in terms of their contribution to the total risk will be conditional on all the above-mentioned factors, and should be seen as valid only for this specific assessment, i.e. it does not necessarily represent the ranking of the “actual” risks.

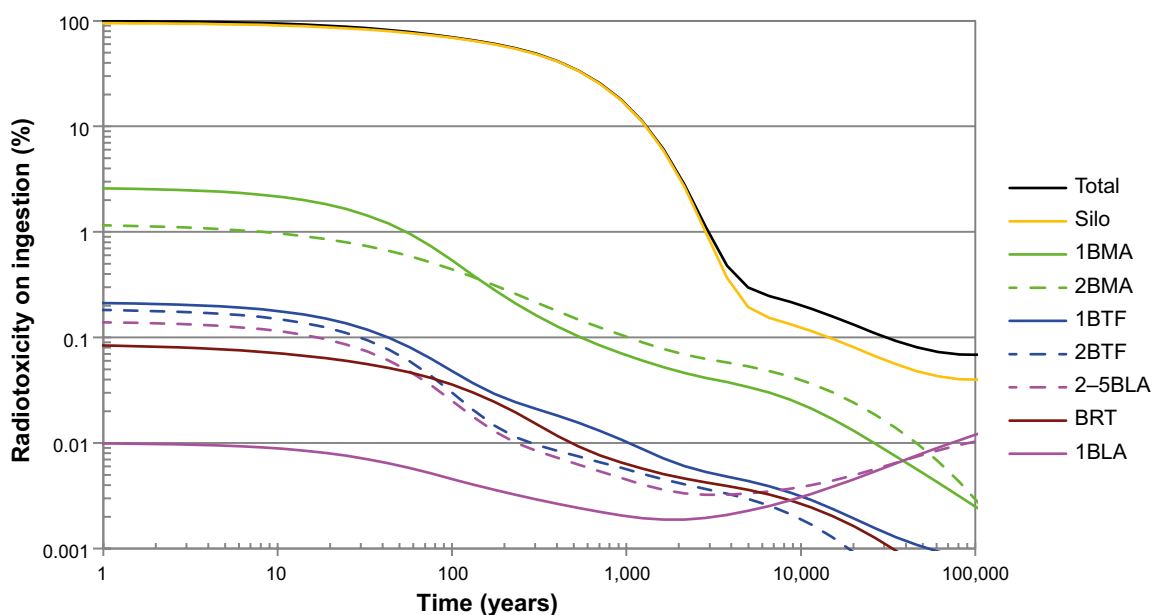
Nevertheless, discussing the contributions from the different waste vaults and radionuclides is useful for understanding the assessment results, analysing and managing the uncertainties in the assessment, and for identifying areas where improvements in knowledge, assessments models and input data are required.

### 10.6.1 Contribution to total radiological risk from different waste vaults

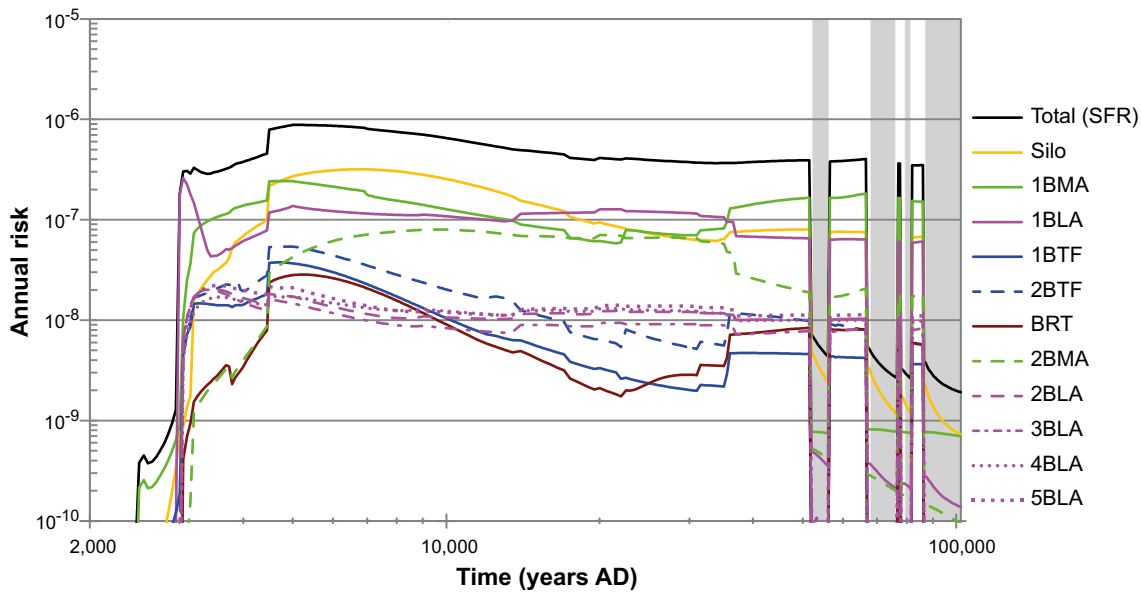
The contributions to total risk from different waste vaults will depend on the radionuclide inventory and radiotoxicity of the waste and the retention capacity of the barrier system. As can be seen in Figure 10-7, the radiotoxicity of the waste is highest in the waste vaults that have the most sophisticated engineering barriers (silo, 1BMA and 2BMA).

When analysing the contributions from different waste vaults to the total risk, it must be considered that the radiotoxicity of the waste generally decreases with time and only 1% of the initial radiotoxicity remains after about 3,000 years.

The relative contribution to risk from different waste vaults changes with time. Figure 10-8 shows the radiological risk from each individual waste vault together with the total risk for the whole SFR repository.



**Figure 10-7.** Percentage contribution to total radiotoxicity, of dominant radionuclides in SFR waste, as a function of time subsequent to closure of the repository. The percentage is related to the total radiotoxicity at closure. The radiotoxicity of the waste in BLA increases with time due to chain decay.



**Figure 10-8.** Contribution to total radiological risk from each waste vault. The unshaded areas correspond to temperate climatic conditions and the grey shaded areas to periglacial conditions with continuous permafrost.

During an initial period (peak at 3000 AD), 1BLA contributes the most to the total radiological risk due to the *intrusion wells scenario*. Thereafter and for the rest of the first temperate period, the highest contribution to the total risk comes from the silo, 1BMA and 1BLA.

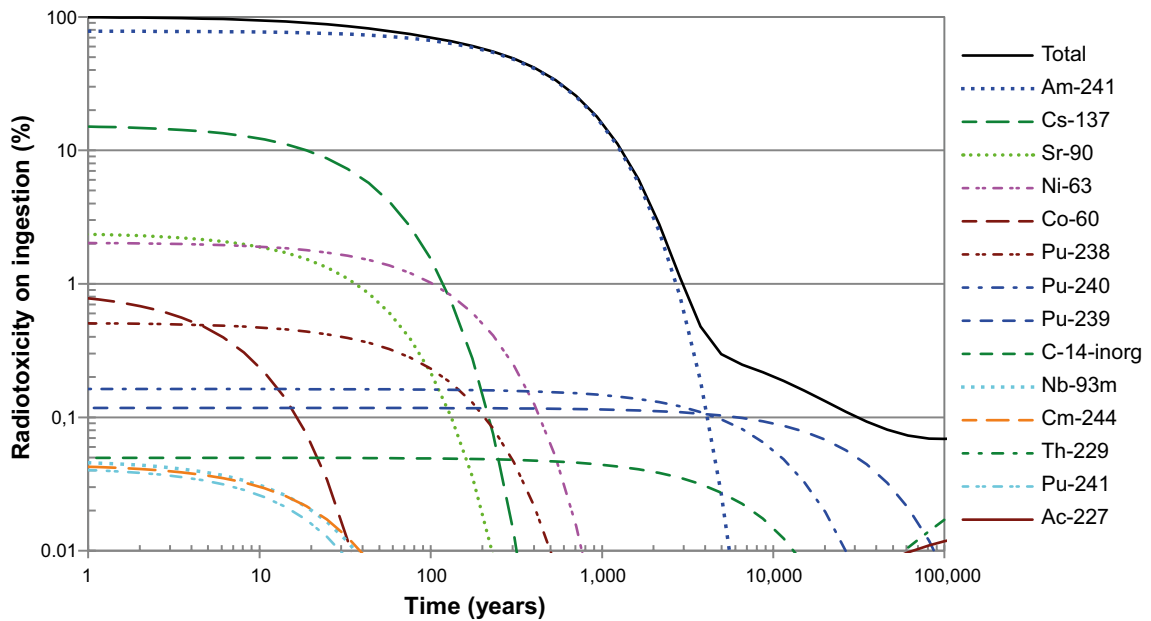
### 10.6.2 Contribution to total radiological risk from different radionuclides

The relative contribution to total risk from different radionuclides will depend on the radionuclide inventory and radiotoxicity of the wastes and the retention capacity of the barrier system. As can be seen in Figure 10-9 the radionuclide inventory and the level of radiotoxicity changes throughout the assessment.

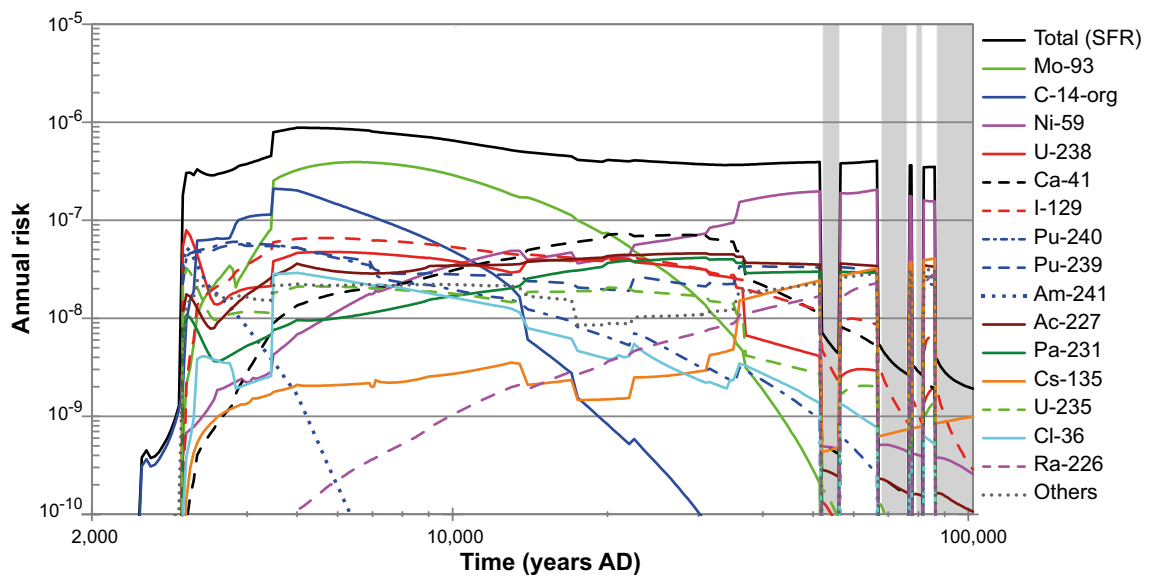
During the operational period, the inventory of short-lived radionuclides like Co-60 decreases substantially. Approximately 300 years after repository closure, the inventory of short-lived radionuclides (half-lives less than 31 years) is 1/1,000 of the initial inventory and, after 3,000 years, the activity of these short-lived radionuclides is negligible. At that time, only radionuclides defined as long-lived remain. Of these, Am-241 contributes the most to the total radiotoxicity of the repository until about 4,000 years after closure. After this, and for the majority of the analysed period, the radiotoxicity is dominated by Pu-239, Pu-240; in the end of the assessment the radiotoxicity is dominated by Th-229 and Ac-227. It can be noted that the radionuclides that contribute the most to the radiotoxicity all are relatively immobile under repository conditions.

Figure 10-10 shows the contribution to the total risk from the radionuclides that contributes most to the total risk. Other, more mobile, radionuclides than those dominating the radiotoxicity contribute the most to the radiological risk. One exception to this is, however, the early contribution from U-238 in the *intrusion wells scenario* for 1BLA.

As is apparent from Figure 10-10, the pattern of the relative contribution to the risk from different radionuclides is rather complex. Nevertheless, the following radionuclides can be identified as important risk contributors in different time periods: C-14, Ni-59, Mo-93, I-129 and U-238. Of these, C-14 and Mo-93 have short enough half-lives to decay to insignificant levels over the assessment period. More long-lived radionuclides such as Ni-59, I-129 and U-238 contribute to the risk during the entire assessment period.



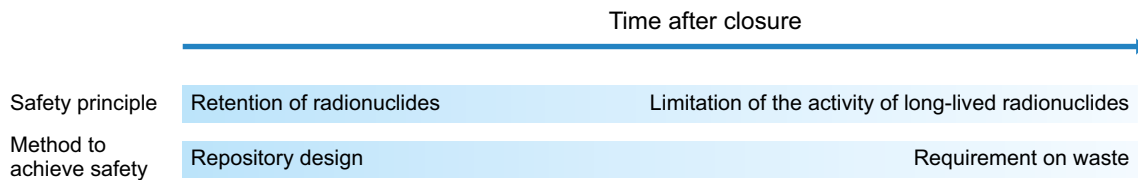
**Figure 10-9.** Percentage contribution to total radiotoxicity, of radionuclides in SFR waste, as a function of time subsequent to closure of the repository. The percentage is related to the total radiotoxicity at closure.



**Figure 10-10.** Contribution to total radiological risk from each radionuclide. The unshaded areas correspond to temperate climatic conditions and the grey shaded areas to periglacial conditions with continuous permafrost.

In Chapter 2, the safety principles of SFR and the methods to achieve safety were discussed, see also Figure 10-11. It is obvious that the chosen design contributes more to safety for radionuclides with a shorter half-life than for radionuclides with a longer half-life. Based on half-life, it is therefore meaningful to define two categories of long-lived radionuclides. In the following sections these two categories of radionuclides are discussed.

- Radionuclides with a half-life short enough so that the inventory will be affected by decay during time-periods of relevance for the chosen design. For these radionuclides, the lifetime of the repository barriers is of more relevance for the long-term safety than the initial inventory.
- Radionuclides with a half-life long enough so that the inventory will not be significantly affected by decay during the assessment period. For these radionuclides, the initial inventory is of more relevance for the long-term safety than the lifetime of the repository barriers.



**Figure 10-11.** Methods to achieve safety on short- and long-term. The figure shows the relative importance of the two safety principles as a function of time for the post-closure phase. Initially, the design of the repository provides a higher degree of retention than for latter times when structures in the repository may be degraded. At these latter times, the limited amount of long-lived radionuclides originally disposed in the repository is essential for safety.

### **Long-lived radionuclides that will decay substantially over the assessment time-scale**

In the current section, long-lived radionuclides with a half-life short enough so that the inventory will be affected by decay during time-periods of relevance for the chosen design are discussed. Time-periods of relevance are the following:

- The time it takes until the shoreline passes the repository and the hydrogeological gradient increases. As seen in Chapter 6, the time for this is approximately 1,000 years. During this period, radionuclides with a half-life of approximately 100 years, such as Ni-63, will have decayed substantially.
- The time it takes until the 1BMA and 2BMA waste vaults lose their flow-limiting capability due to barrier degradation. In the main scenario it is assumed that the hydraulic contrast between the concrete and the backfill decreases to 1/100 at 22,000 AD.
- The time it takes for the first permafrost to reach repository depth. In the *global warming variant of the main scenario* it happens at 52,000 AD and in the *early periglacial variant of the main scenario* it happens at 17,500 AD. At that time, radionuclides with a half-life of a few thousand years, such as C-14 (5,730 years) and Mo-93 (4,000 years), have decayed substantially.

### **Contribution of Molybdenum-93**

Mo-93 is an activation product with a half-life of 4,000 years. The main inventory of Mo-93 is in the silo, 2BMA, BRT, and 1BMA (Figure 10-12). Figure 10-13 shows the average release of Mo-93 from each of the waste vaults in SFR. The peak release is observed early for the 1BLA, 1BTF, 2BTF, and BRT waste vaults that have a lower retention capacity than the 1BMA, 2BMA waste vaults and the silo.

### **Contribution of organic Carbon-14**

C-14 has a half-life of 5,730 years. The main inventory of C-14 is in organic form and is in the silo and 1BMA (Figure 10-14). Figure 10-15 shows the average release of organic C-14 from each of the waste vaults. The peak release is observed for the silo and 1BMA. The release is based on the assumption that the concrete barriers in 1BMA, 2BMA and the silo are able to maintain high pH during 20,000 years.

In the safety assessment SAR-08 (SKB 2008a), C-14 was shown to contribute most to the radiological risk. In this safety assessment, uncertainties for the inventory and in modelling of C-14 have been reduced and thereby C-14 is no longer the radionuclide that contributes most to radiological risk, although it is still of importance for the risk in the initial time periods of the safety analysis (Figure 10-10).

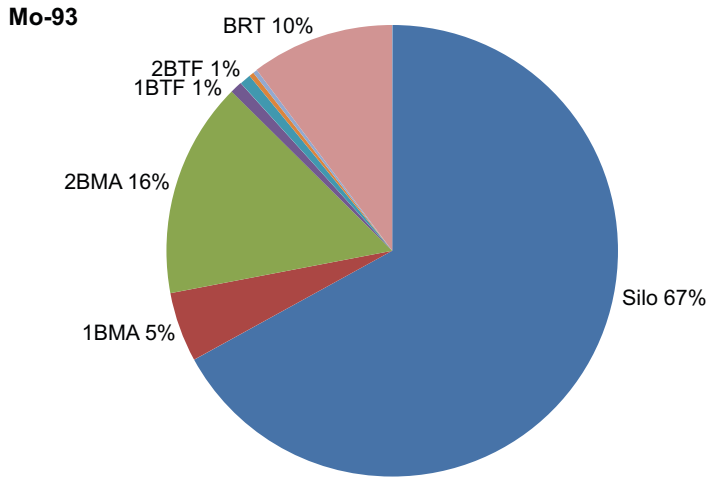


Figure 10-12. Inventory of Mo-93 per waste vault.

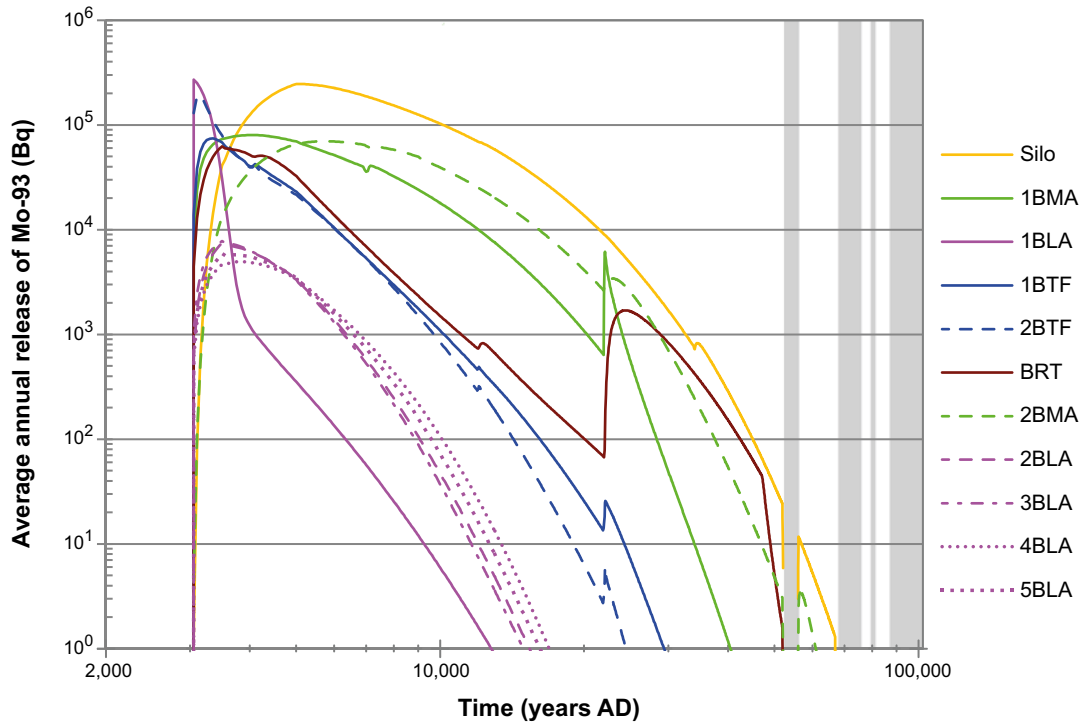


Figure 10-13. Average releases from the far-field of Mo-93 from each of the waste vaults shown for the global warming calculation case. The unshaded areas correspond to temperate climatic conditions and the grey shaded areas to periglacial conditions with continuous permafrost.

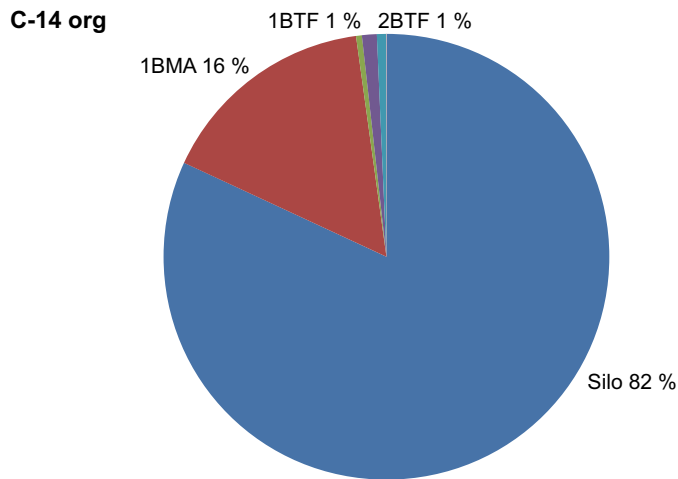


Figure 10-14. Inventory of organic C-14 per waste vault.

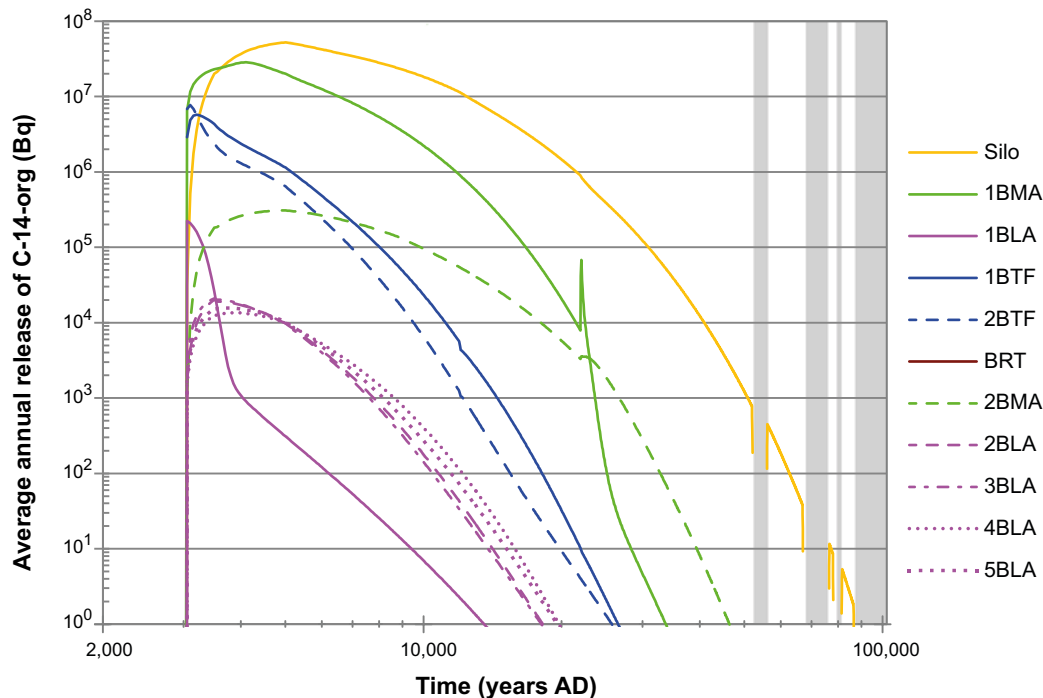


Figure 10-15. Average releases from the far-field of organic C-14 from each of the waste vaults shown for the global warming calculation case. The unshaded areas correspond to temperate climatic conditions and the grey shaded areas to periglacial conditions with continuous permafrost.

### Contribution of Americium 241

Am-241 is an actinide with a half-life of 432 years. The main inventory of Am-241 relates to smoke detectors and is found in the silo (Figure 10-16). A small portion of the radionuclide inventory is also found in other waste vaults and due to the barriers of the silo, release of Am-241 is dominated by these other waste vaults (Figure 10-17). Am-241 contributes significantly to highest dose in some scenarios – e.g. Am-241 contributes almost 18% to the highest dose in the *intrusion wells scenario* for 1BLA. In that scenario, it is assumed that wells can be drilled from 3000 AD onwards. When estimating the dose in the *intrusion wells scenario*, the concentration of radionuclides in the well water is set equal to the pore water concentration in the backfill of the waste vault. The waste type that contributes the most to this pessimistic estimation of radiological risk from 1BLA is S.14. The fact that the waste in S.14 is embedded in concrete and that the waste package has both a flow limiting and sorbing capacity is pessimistically not taken into account in the assessment. Although the



processes are pessimistically not included in calculations of the radiological risk, Am-241 and other radionuclides will sorb on different materials, resulting in lower concentrations than those assumed and accordingly also a lower risk.

The probability for a well being drilled into the repository was set as constant throughout the assessment time period, although there might be a tendency of having a lower density of wells in the direct vicinity of the sea due to the risk of salt water intrusion. Moreover, if global warming leads to increased sea levels, it will result in a longer time until a well might be drilled and allow Am-241 to decay. Relaxing these pessimistic assumptions would clearly result in a lower radiological risk for Am-241.

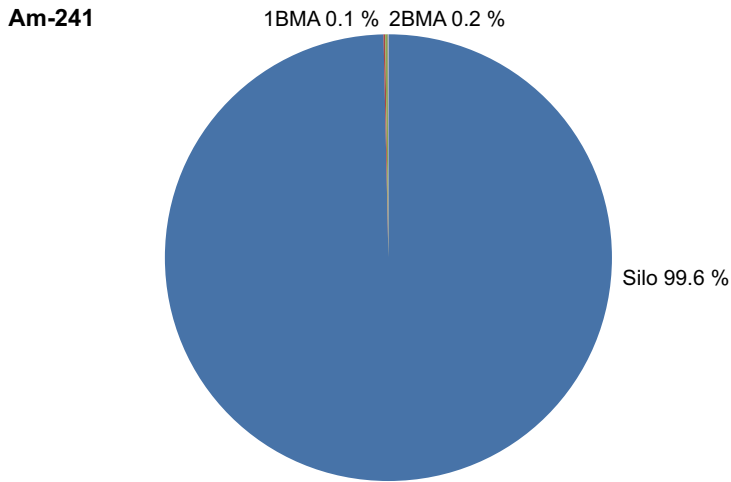


Figure 10-16. Inventory of Am-241 per waste vault.

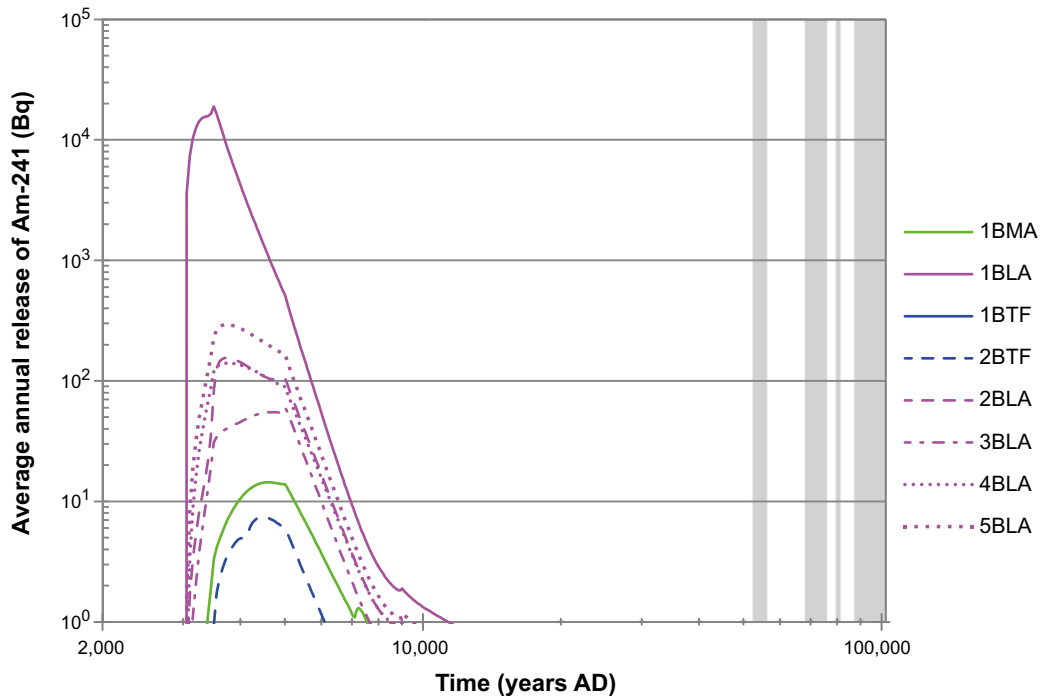


Figure 10-17. Average releases from the far-field of Am-241 from each of the waste vaults shown for the global warming calculation case. The unshaded areas correspond to temperate climatic conditions and the grey shaded areas to periglacial conditions with continuous permafrost.

### ***Long-lived radionuclides that will not decay substantially over the assessment time-scale***

As given in the regulations (SSMFS 2008:37), a safety assessment for a repository for nuclear waste that is not long-lived (or spent fuel) should be carried out for a time period of up to 100,000 years. The arguments for the selected limitations of the risk analysis should be presented. In SFR only limited amounts of long-lived radionuclides are accepted. However, at the end of the 100,000 year assessment period when the short-lived radionuclides have decayed only long-lived radionuclides remain and contribute to the total risk. Complying with the regulatory risk criteria throughout the assessment period shows that only limited amount of long-lived radionuclides will have been deposited in the repository.

One way of showing that the level of long-lived radioactivity is insignificant is to compare the average concentration of radionuclides in the waste with corresponding clearance levels for materials (SSMFS 2011:2). Figure 10-18 and Figure 10-19, show the ratios between the average concentrations in the waste and the clearance levels for each waste vault (the radionuclides are sorted according to half-lives). Most of the activity is deposited in the silo (Table 4-6), but also for the silo the average activity concentrations of the more long-lived radionuclides are below or at least close to clearance levels.

Based on a 100,000 year assessment time-period, Ni-59 and radionuclides with a longer half-life are regarded as radionuclides for which radioactive decay has limited influence on the radioactive inventory. In the following text, the contributions of Ni-59, I-129 and U-238, three long-lived radionuclides that make significant contributions to the total risk during the entire assessment period, are discussed.

#### **Contribution of Nickel-59**

Ni-59 has a half-life of 76,000 years and dominates the total risk at the end of the assessment time period (Figure 10-10). The majority of the Ni-59 inventory is found in the silo (Figure 10-20). At the time of closure, the average concentration of Ni-59 in the silo is approximately twice the clearance level. Due to the long half-life of Ni-59, no major reduction of the inventory will occur due to decay over the assessment time period. However, after 100,000 years the average activity concentration of Ni-59 in the silo corresponds to that for clearance (without taking into account outward transport).

Figure 10-21 illustrates the average release of Ni-59 from each of the waste vaults. The sources of release from the repository are mainly from the 1BMA, 2BTF, 1 BLA, and the silo.

Calculations indicate that some 900 kg of inactive Ni will be deposited in SFR in the spent ion-exchange resins originating from the reactor coolant cleaning system and the condensate cleaning system. Taking the inventory of stable Ni isotopes and the low solubility of Ni under the conditions found in the repository, it is most likely that Ni will be solubility limited setting an upper bound on Ni available for transport. This has not been included in the present analysis, but the impact on the total risk may, however, be further investigated if this is deemed necessary to enhance the safety argument.

#### **Contribution of Iodine-129**

I-129 is a fission product that has a half-life of  $1.57 \cdot 10^7$  years. The majority of the I-129 inventory is found in the silo (Figure 10-22). The main release of I-129 is from the silo and 1BMA (Figure 10-23). At the time of closure, the average concentrations of I-129 in all waste vaults are below the corresponding concentration for clearance (Figure 10-18 and Figure 10-19).

As can be seen in Figure 10-10, the contribution of I-129 to the total risk is relatively small during temperate periods. During periglacial periods, the contribution from I-129 is more significant, but the total risk is then negligible (less than  $10^{-8}$ ).

#### **Contribution of Uranium-238**

U-238 is an actinide with a half-life of  $4.5 \cdot 10^9$  years. The main inventory of U-238 is part of the legacy waste stream and can be found in 1BLA (Figure 10-24).

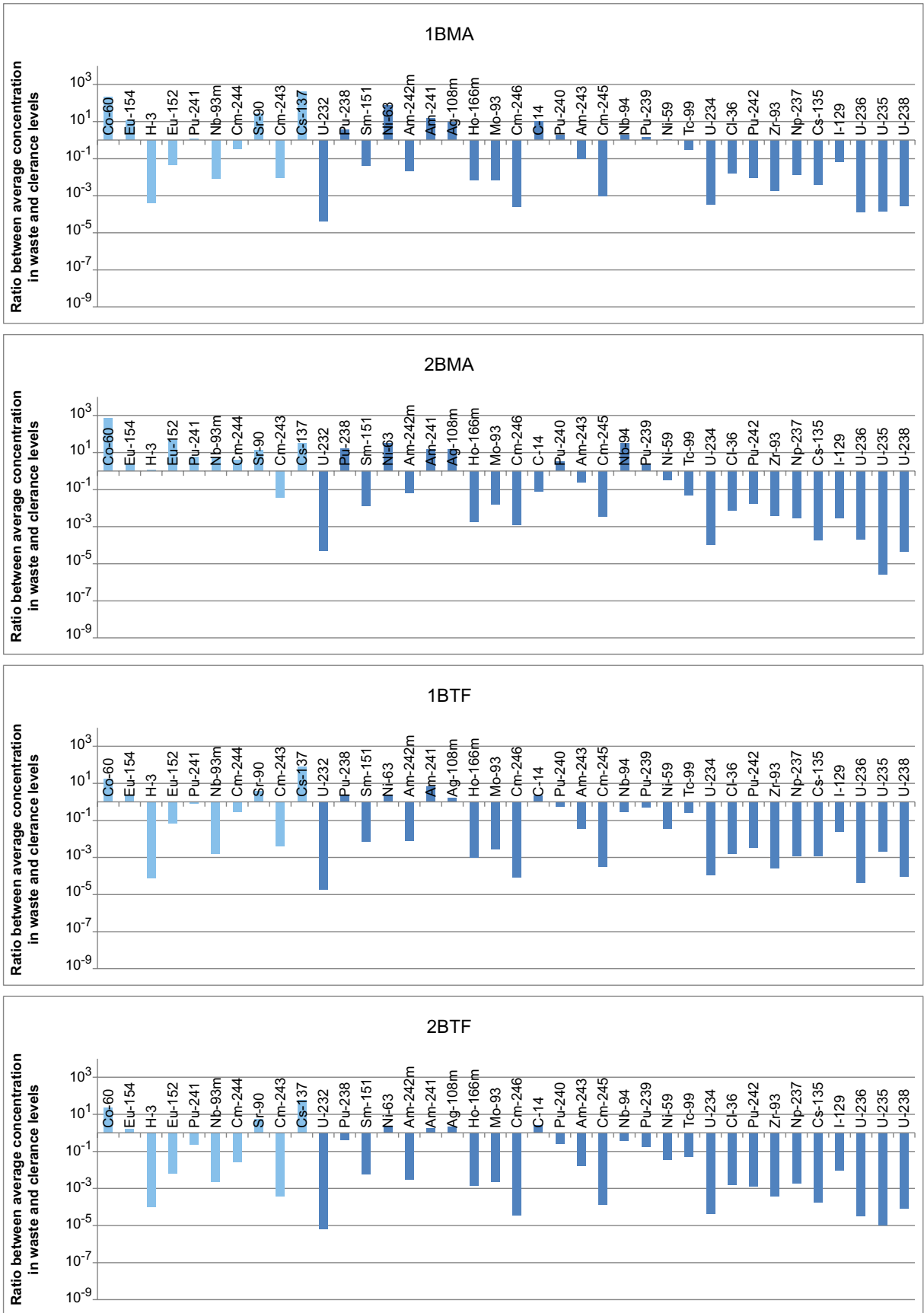


Figure 10-18. Ratio between average radionuclide concentrations in the waste (at closure) and clearance levels in the waste vaults 1-2BMA and 1-2BTF. Light blue bars represents short-lived radionuclides.

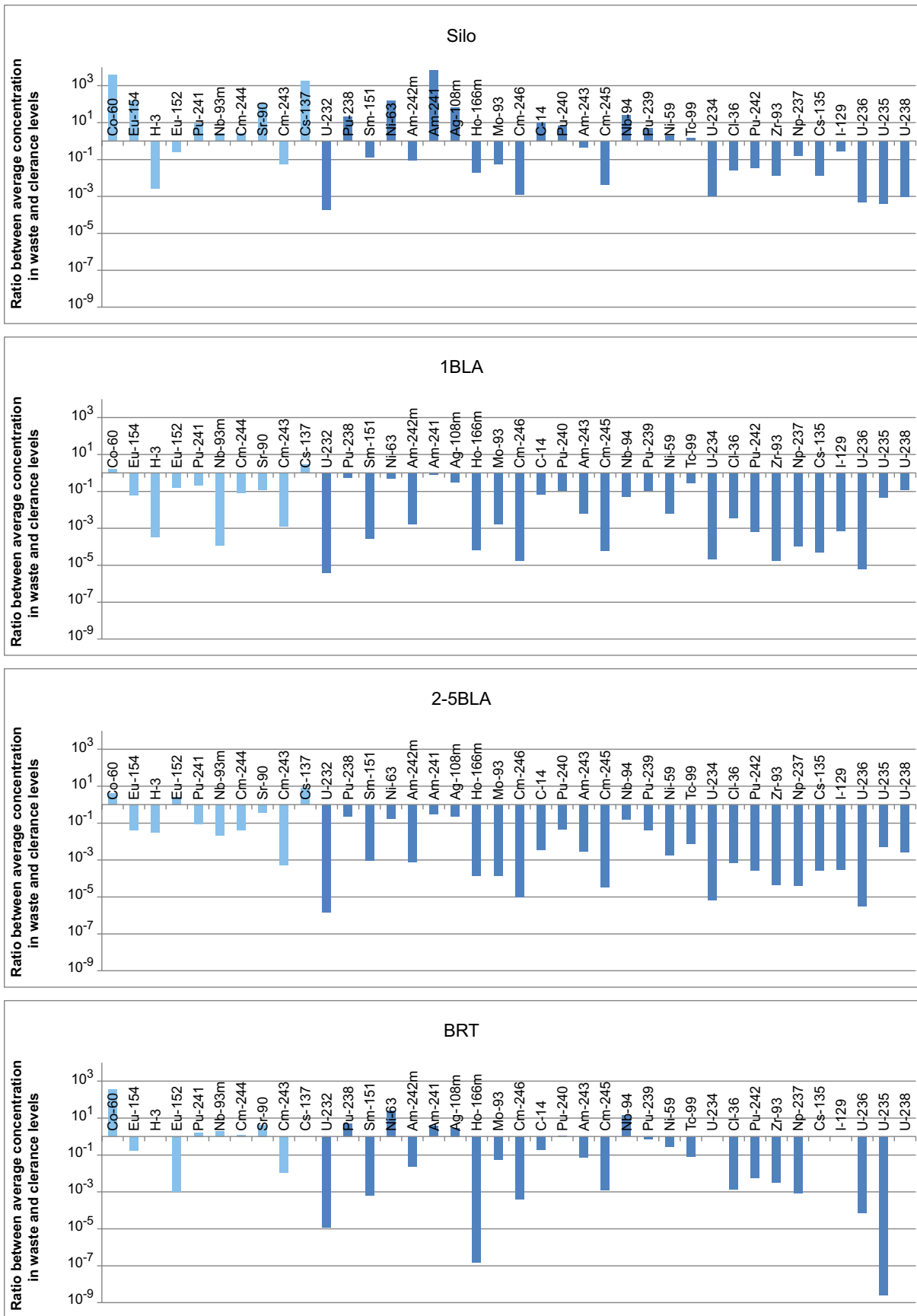


Figure 10-19. Ratio between average radionuclide concentrations in the waste (at closure) and clearance levels in the waste vaults silo, 1–5 BLA and BRT. Light blue bars represents short-lived radionuclides.

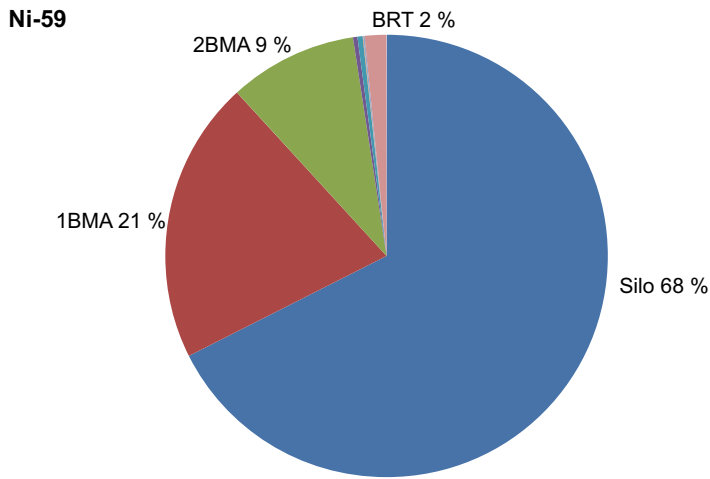


Figure 10-20. Inventory of Ni-59 per waste vault.

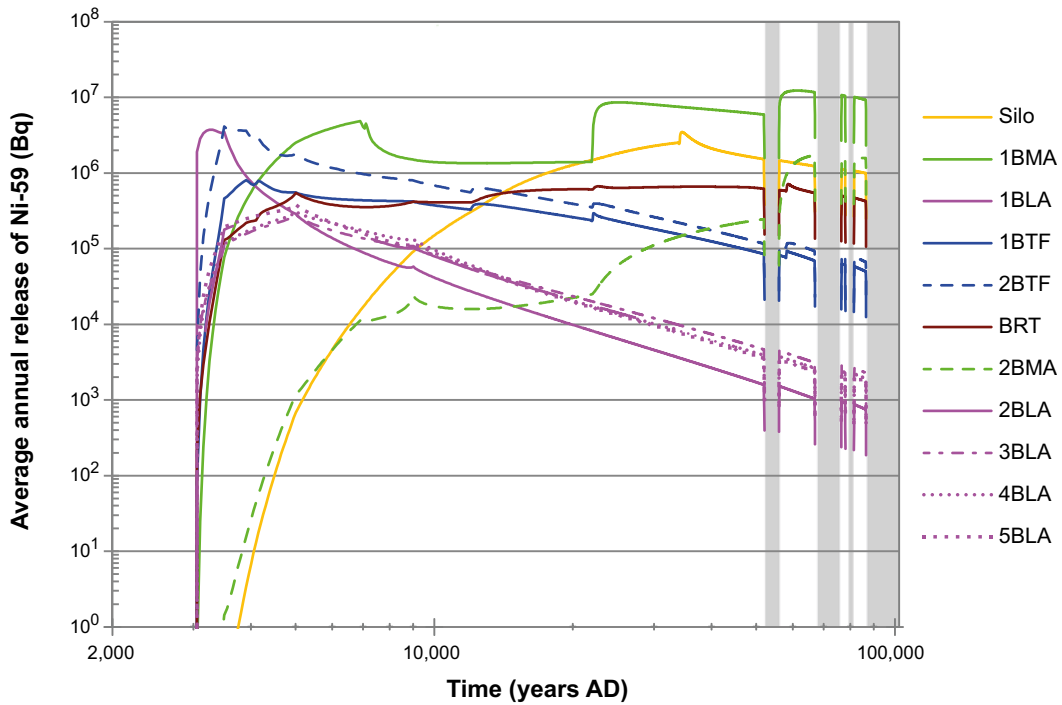
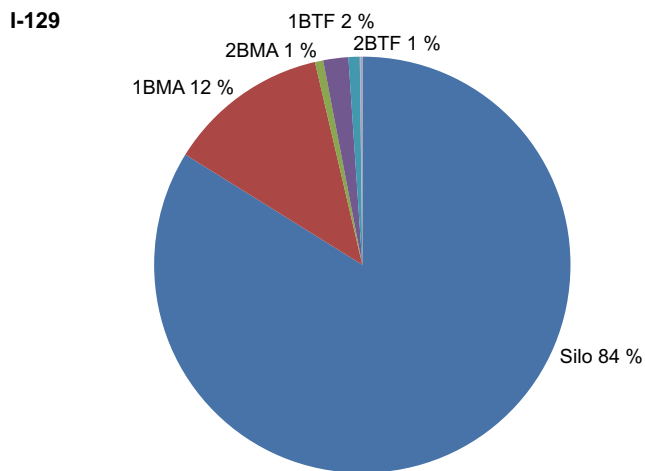
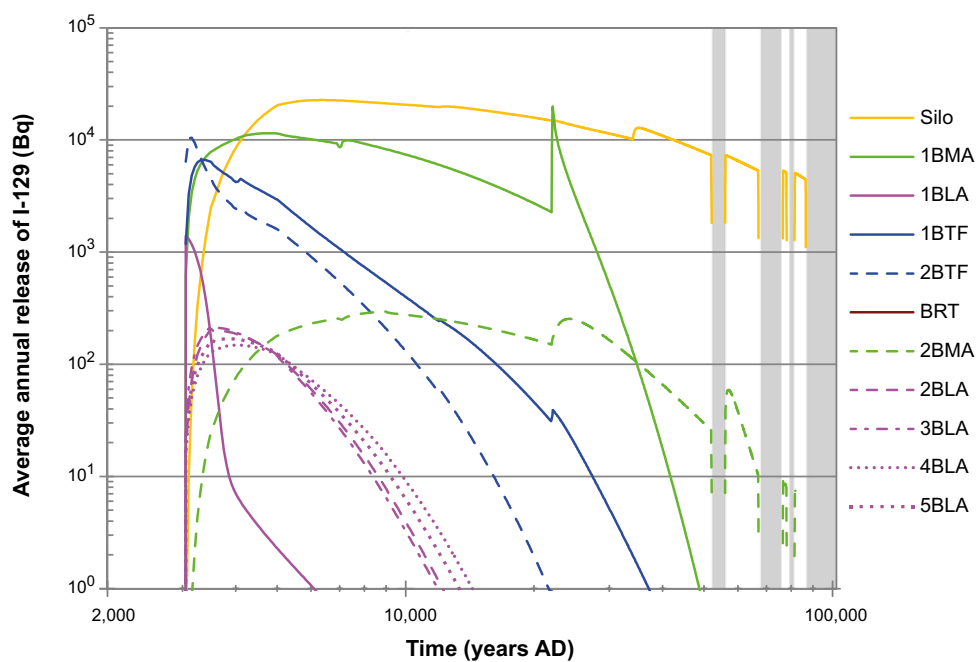


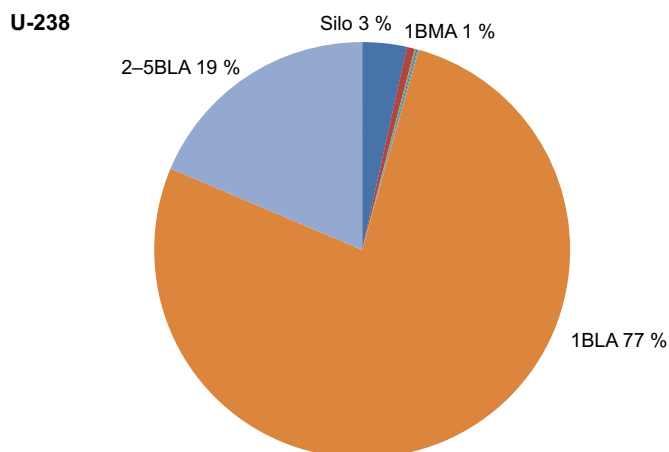
Figure 10-21. Average releases from the far-field of Ni-59 from each of the waste vaults shown for the global warming calculation case. The unshaded areas correspond to temperate climatic conditions and the grey shaded areas to periglacial conditions with continuous permafrost.



**Figure 10-22.** Inventory of I-129 per waste vault.



**Figure 10-23.** Average releases from the far-field of I-129 from each of the waste vaults shown for the global warming calculation case. The unshaded areas correspond to temperate climatic conditions and the grey shaded areas to periglacial conditions with continuous permafrost.



**Figure 10-24.** Inventory of U-238 per waste vault.

Figure 10-25 illustrates the average release rate of U-238 from each of the waste vaults and shows that 1BLA dominates the release. The release rate shows a pattern of a fast increase starting from 3000 AD followed by a monotonic decrease during the rest of the assessment period.

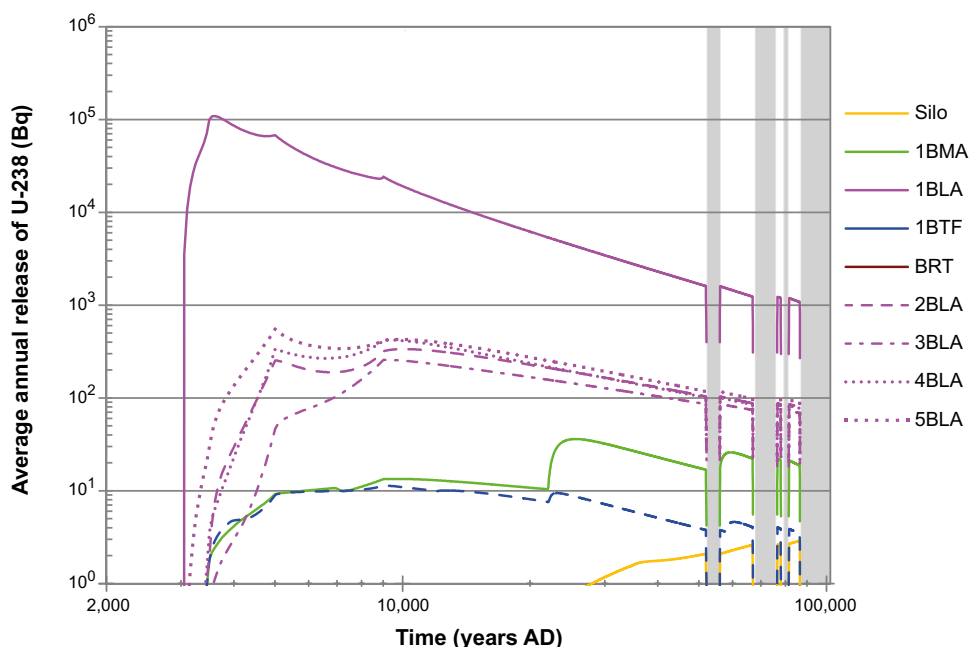
The release rate for 1BLA relates to the assumption of not considering any retention in 1BLA. Assuming no retention is normally a cautious assumption with respect to radiological risk, but for U-238, this assumption may not be cautious since a higher retention would result in more progeny in the waste vaults at later times. The effect of a higher retention was investigated in the variant *1BLA intrusion well with alternative transport properties*, see Section 9.3.8. It is shown that retention and a lower outward transport from 1BLA would, in fact, lower the total radiological risk, even though the contribution from progeny would increase (Figure 9-40).

### 10.6.3 Risk dilution

SSMFS 2008:37 provides guidance on how to deal with the issue of risk dilution that can arise in probabilistic calculations of risks for certain types of scenarios. By risk dilution it is meant that the annual risk can be underestimated if it is taken as the mean value from a number of probabilistic calculations. This could be the case for event-driven scenarios, such as the *earthquake* and *well scenarios*.

For times after closure, annual risks were estimated for a maximally exposed individual from a generation living at a given time point, taking into account the contribution from events before this time point. These annual risk estimates are appropriate for comparison with the regulatory risk criteria; which is necessary for demonstrating compliance with the regulatory requirements.

In addition, to address the issue of risk dilution for event-driven scenarios, as recommended in SSMFS 2008:37, for each time, accumulated annual risks have also been calculated. This is defined as the annual risk to a hypothetical maximally exposed individual taken from all future generations that might be affected by an event that has occurred at this time point. This accumulated risk has been estimated by multiplying the maximum annual doses over time resulting from an event occurring at a given time interval by the cumulative probability that the event has occurred before this time interval.



**Figure 10-25.** Average releases from the far-field of U-238 from each of the waste vaults shown for the global warming calculation case. The unshaded areas correspond to temperate climatic conditions and the grey shaded areas to periglacial conditions with continuous permafrost.

This is illustrated below for the *intrusion wells scenario* and the *wells downstream of the repository scenario*. For these calculations it is assumed that: i) there is an equal probability for an intrusion or downstream well over any 50-year interval, ii) the exposures from the well outside this time interval can be neglected, iii) the well will not affect the repository evolution. The cumulative probability that at least one well has existed in the vicinity of the repository area before a future time will increase with time and will sooner or later become equal to 1. This cumulative probability is calculated here as follows:

$$P(t) = 1 - (1 - p)^{n(t)} \quad \text{(Equation 10-4)}$$

where  $p$  is the probability per generation that one of the wells is located in the repository (*intrusion wells scenario*) or in the discharge area (*wells downstream of the repository scenario*) and  $n$  is the number of generations that have passed. A generation is assumed to last for 30 years.

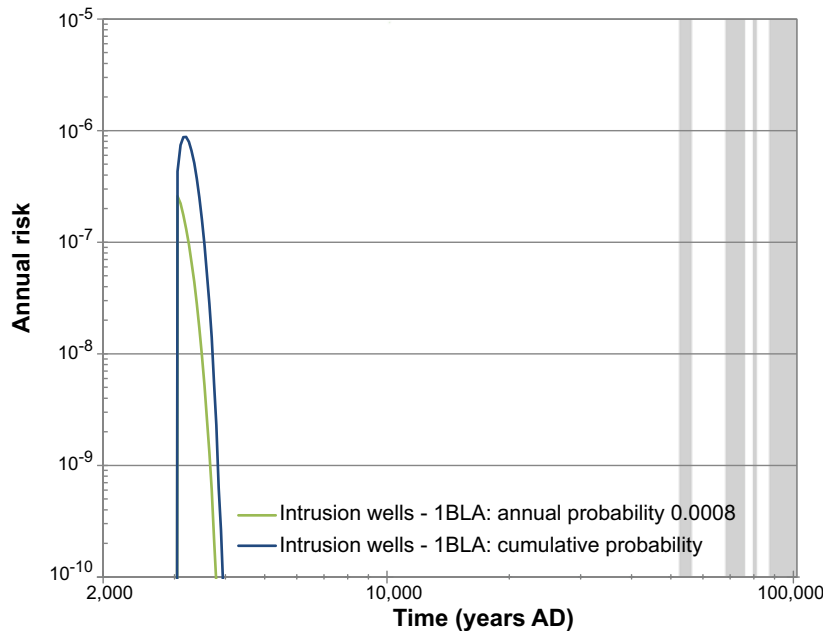
### **Intrusion wells scenario**

Figures 10-26, 10-27 and 10-28 show the risk for the *intrusion wells scenario*, for 1BLA, 1BMA and the silo, respectively. The risk has been calculated by applying an annual probability of 0.0008 for 1BLA and 1BMA and 0.0002 for the silo and the corresponding accumulated risks obtained by using cumulative probabilities according to equation 10-4. The first generation to be exposed to any risk is assumed to live at year 3000 AD, when it is assumed that wells can be drilled into the repository.

As expected, the accumulated annual risks considering all generations are higher than the annual risks for each generation. Nevertheless, the values of the accumulated annual risk obtained for the *intrusion wells scenario* for all generations are lower than the high end of the regulatory risk criteria, i.e. below  $10^{-5}$ .

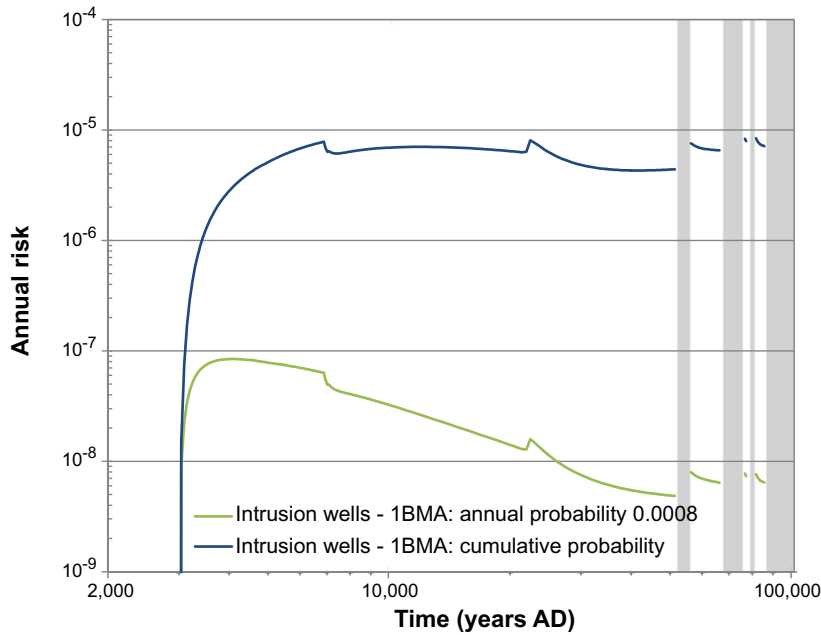
### **Wells downstream of the repository scenario**

Figure 10-29 shows the risk for the *wells downstream of the repository scenario* calculated by applying an annual probability of 0.13 and the “total” risk by applying the cumulative probability (according to equation 10-4). The first generation to be exposed to any risk is assumed to live at year 3000 AD, when the releases are assumed to commence in the *global warming calculation case*.

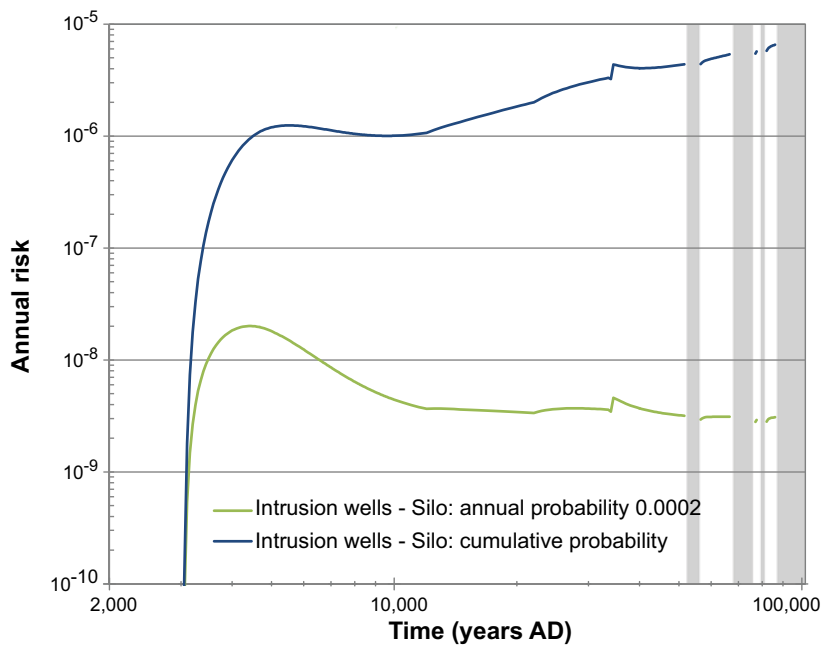


**Figure 10-26.** Effect of risk dilution for 1BLA in the *intrusion wells scenario*. The unshaded areas correspond to temperate climatic conditions and the grey shaded areas to periglacial conditions with continuous permafrost. Permafrost prevents wells and well scenarios have therefore not been analysed during these periods.

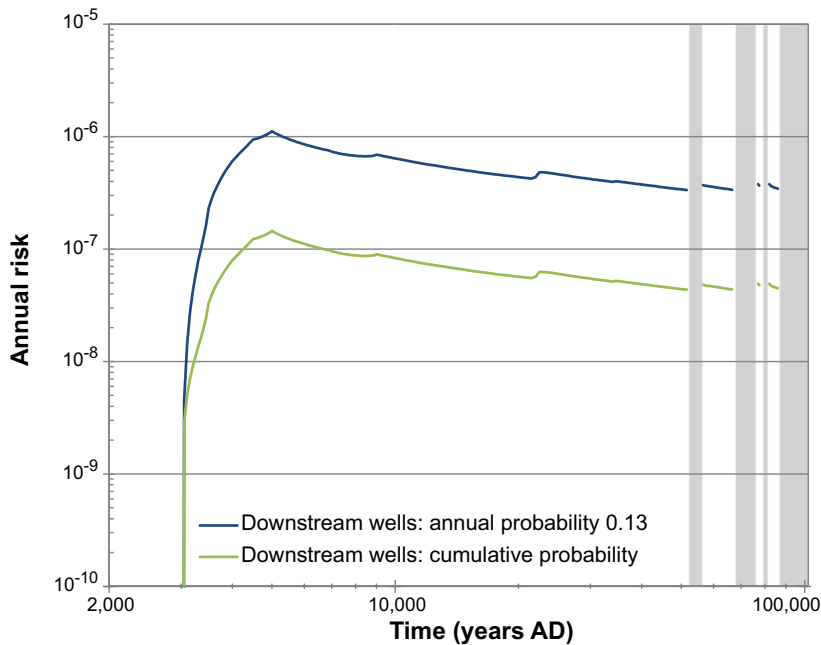




**Figure 10-27.** Effect of risk dilution for 1BMA in the **intrusion wells scenario**. The unshaded areas correspond to temperate climatic conditions and the grey shaded areas to periglacial conditions with continuous permafrost. Permafrost prevents wells and well scenarios have therefore not been analysed during these periods.



**Figure 10-28.** Effect of risk dilution for the silo in the **intrusion wells scenario**. The unshaded areas correspond to temperate climatic conditions and the grey shaded areas to periglacial conditions with continuous permafrost. Permafrost prevents wells and well scenarios have therefore not been analysed during these periods.



**Figure 10-29.** Effect of risk dilution for the *wells downstream of the repository scenario*. The unshaded areas correspond to temperate climatic conditions and the grey shaded areas to periglacial conditions with continuous permafrost. Permafrost prevents wells and well scenarios have therefore not been analysed during these periods.

As expected, the accumulated annual risks considering all generations are higher than the annual risks for each generation. Nevertheless, the values of the accumulated annual risk obtained for the *wells downstream of the repository scenario* for all generations are lower than the high end of the regulatory risk criteria, i.e. below  $10^{-5}$ .

#### 10.6.4 Additional safety indicators

The general advice to SSMFS 2008:37 suggest that alternative safety indicators should be used for longer time periods. Below, the estimated concentrations in the environment for the main scenario have been compared with concentrations of naturally occurring radionuclides.

##### **Concentration in the environment of naturally occurring radionuclides**

U-238 and Ra-226 are both naturally occurring radionuclides. In order to illustrate the radiological consequence of the repository, a comparison of the calculated environmental concentrations (in the main scenario) of these with the background (i.e. natural) concentrations in Forsmark is presented in Table 10-4. It can be seen that the calculated concentrations are below background levels. Potential releases from the repository will not lead to a significant increase of environmental concentrations of U-238 and progeny.

A study of 818 Swedish wells made by SGU and SSI (Ek et al. 2007) also shows that the calculated concentrations in well water obtained for the main scenario (Table 10-4) are well below those occurring in natural ground waters, Table 10-5.

**Table 10-4. Comparison of environmental concentration maxima obtained for the main scenario against typical background concentrations in Forsmark (Table 10-3, SKB 2010e).**

Radionuclide	Concentrations in soil <sup>1</sup> , (Bq kg DW <sup>-1</sup> )		Concentrations in surface waters, (Bq L <sup>-1</sup> )		Concentrations in drilled well water (Bq L <sup>-1</sup> )	
	Main scenario	Top soil, Forsmark	Main scenario	Lake water, Forsmark	Main scenario	Near surface groundwater, Forsmark
U-238	3.2	4.6·10 <sup>1</sup>	3.2·10 <sup>-4</sup>	1.5·10 <sup>-2</sup>	4.9·10 <sup>-6</sup>	7.4·10 <sup>-2</sup>
Ra-226	8.8·10 <sup>-4</sup>	3.9·10 <sup>1</sup>	4.0·10 <sup>-7</sup>	6·10 <sup>-3</sup>	9.3·10 <sup>-6</sup>	7.2·10 <sup>-2</sup>

<sup>1</sup> regoUp, see the **Biosphere synthesis report**.

**Table 10-5. Concentration in 818 wells in Sweden (Ek et al. 2007).**

Radionuclide	Min (Bq L <sup>-1</sup> )	Average (Bq L <sup>-1</sup> )	Max (Bq L <sup>-1</sup> )
U-238 <sup>1</sup>	3.7·10 <sup>-4</sup>	2.2·10 <sup>-1</sup>	1.3·10 <sup>1</sup>
Ra-226	2·10 <sup>-2</sup>	9.4·10 <sup>-2</sup>	6.0

<sup>1</sup> In the report given as 0.03 µg/L, 18 µg/L and 1,014 µg/L.

## 10.7 Conclusion

In this chapter, the analysis of the results of radiological risk estimations has been presented, with the purpose of demonstrating compliance with the risk criterion. The analysis shows that, despite the cautious assumptions made in the modelling and in the risk calculations, the repository complies with the regulatory criteria. Additionally, the repository would not have any adverse impact on the environment because assessed dose rates to non-human biota are well below recommended screening criteria. Also, comparison with naturally occurring radionuclides shows that potential future concentrations of repository derived radionuclides in the environment would be well below background for the main long-lived radionuclides of concern. Hence, it can be concluded that the repository complies with regulatory requirements regarding protection of human health and protection of the environment.



# 11 Conclusions, further research needs and requirements on design, construction, operation and wastes

## 11.1 Introduction

This chapter presents the conclusions from the SR-PSU project. These conclusions pertain both to the existing SFR 1 and the planned extension SFR 3.

The long-term safety of the existing repository, SFR 1, has been evaluated on several occasions. In each assessment, SKB has concluded that SFR complies with the regulatory requirements. After the latest safety assessment, SAR-08, the regulators issued two injunctions (Appendix C). Both injunctions have been addressed by SKB and it has been shown that the conclusions with respect to regulatory compliance in SAR-08 are still valid.

The long-term-safety of the planned extension, SFR 3, is evaluated for the first time in the present assessment. In the light of this evaluation, the conclusions regarding the long-term safety of the existing facility have also been revisited.

Three major roles for the presentation of the conclusions from the SR-PSU project can be distinguished:

1. To demonstrate compliance with applicable Swedish regulations for the disposal of radioactive wastes in the SFR repository in Forsmark.
2. To identify requirements and constraints that needs to be satisfied for the conclusions of the safety assessment to be valid.
3. To provide feedback to design development, to SKB's RD&D Programme, to detailed site investigations and to future safety assessment projects.

The regulations set a framework for the methodology for the safety assessment and stipulate quantitative requirements for the radiological safety of the facility from a long-term perspective. Appendices A and B show how and where the requirements in the regulations have been addressed in the present report. The document structure used to report the assessment (Figure 11-1) and the chosen methodology correspond to those used by SKB in the safety assessments for the future Spent Fuel Repository (SR-Site) and for the existing SFR (SAR-08). The methodology has been reviewed by SSM on a number of occasions and has therefore been considered suitable for application in this assessment.

## 11.2 Conclusions

The central conclusion of the safety assessment SR-PSU is that the extended SFR repository (SFR 1 and SFR 3) meets regulatory criteria with respect to long-term safety. The potential impacts of the repository on human health and on the environment have been evaluated according to the regulations, and the main conclusions of this evaluation are presented in Section 11.2.1

The repository design includes a number of barriers that are of crucial importance for the long-term safety of the repository. The barriers and their corresponding barrier functions are presented in Section 11.4. The major assumptions and conclusions related to the evolution of the repository system and its environs are presented in Section 11.3.5, whereas the chosen time scale for the safety assessment is discussed in Section 11.3.2 and the main conclusions concerning confidence in the results of the safety assessment are given in Section 11.4.6.

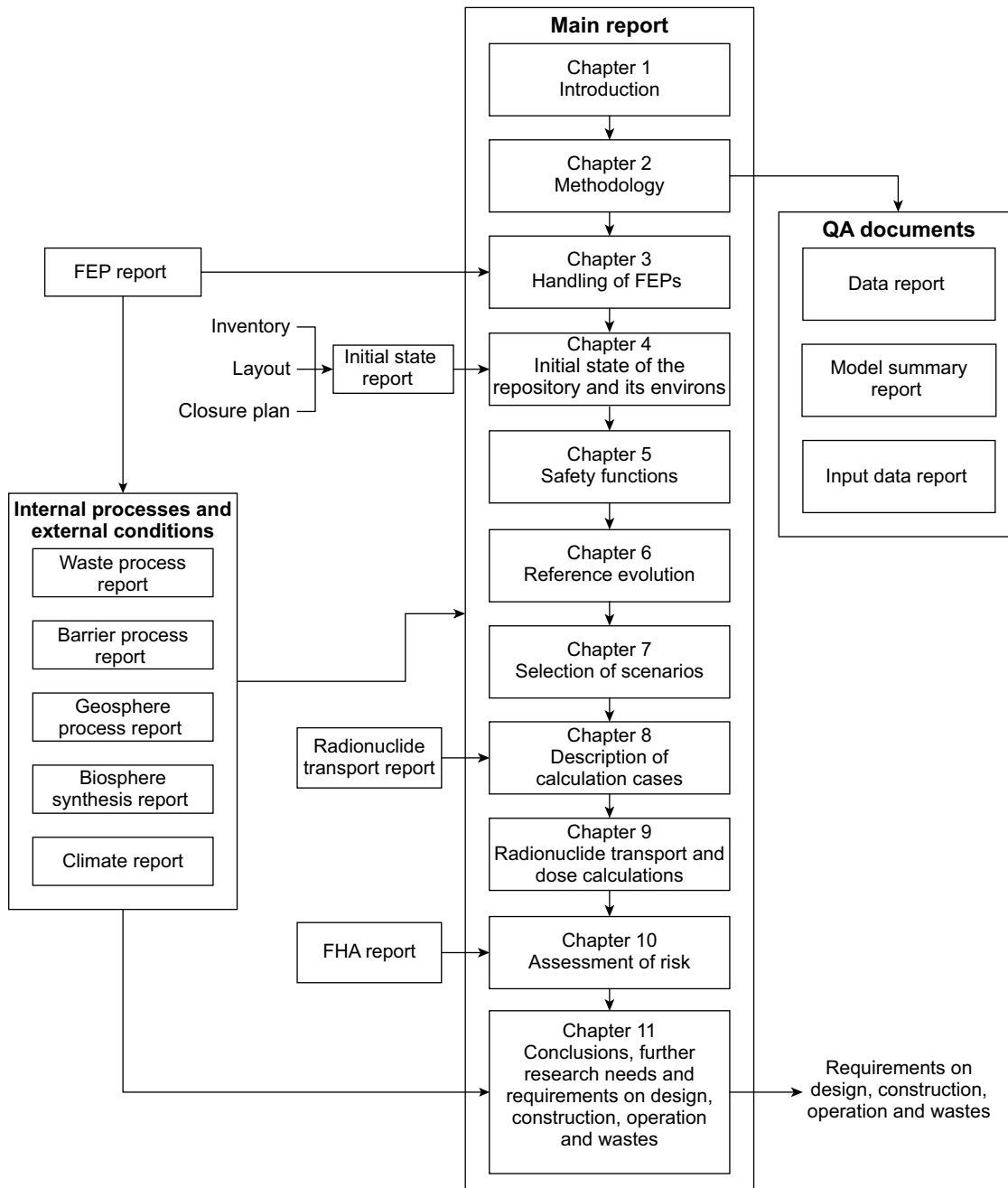
The current safety assessment is described in Section 1.4, with an emphasis on significant improvements as compared to previous safety assessments.

The safety of the repository is naturally dependent on the composition of the waste, especially the amount of radioactivity deposited in each waste vault and in the repository as a whole. As a result of the present safety assessment, a number of additional requirements and constraints on the wastes and on the design, construction and operation of the repository have been identified.

The kind of information used in the assessment of long-term safety, and the iterative nature of the safety assessments, are briefly described in Sections 11.5.1 and 11.5.2, respectively. Finally, further research needs identified within the safety assessment are described in Section 11.5.3.

### 11.2.1 Protection of human health and of the environment

The results of the radiological risk estimations presented in Chapter 10 show that the risks from all individual scenarios, i.e. for each variant of the main scenario and for each less probable scenario, are below the regulatory criterion of  $10^{-6}$  for the annual radiological risk to a representative individual of the most exposed group.



**Figure 11-1.** Report structure of the long-term safety assessment. Each box in the figure corresponds to a report produced within the SR-PSU project or a chapter in the present report.

The risk for a number of combinations of the main scenario and less probable scenarios is also presented in Chapter 10. The risk estimated for each of these scenario combinations is also below the regulatory risk criterion of  $10^{-6}$  during the assessment period of 100,000 years.

The relative contributions of individual radionuclides to the total risk from the repository depend on a number of factors, including the initial inventory of the radionuclides in the wastes, the capacity of the different waste vaults for retention and retardation of the different radionuclides, the behaviour of released radionuclides in the geosphere and biosphere, and the radiotoxicity of the radionuclides. In addition, the estimates of relative risk for individual radionuclides is influenced by the degree of pessimism inherent in the assumptions made in the assessment; i.e. assumptions used to model processes and values assigned to model parameters. Hence, a ranking of the radionuclides in terms of their contribution to the total risk will be conditioned by all above-mentioned factors, and should be seen as valid only for this specific assessment including its pessimisms, i.e. the results do not necessarily represent the ranking of the “actual” risks.

Exposure of non-human biota has been estimated by comparing calculated dose rates to organisms from marine, freshwater and terrestrial ecosystems with the screening values adopted for this assessment (the ERICA screening dose rate of  $10 \mu\text{Gy h}^{-1}$  (Beresford et al. 2007) and the most stringent of the ICRP DCRL's of  $4 \mu\text{Gy h}^{-1}$  (ICRP 2008)). All calculated dose rates were a factor of 100 or more lower than the screening values, indicating that the repository will not affect biodiversity or sustainable use of biological resources.

In the light of the overall results obtained, SKB concludes that the assessment presented here shows that SFR 1 and SFR 3 fulfil the criteria on protection of human health and the environment for final disposal of radioactive waste that have been established by the Swedish radiation safety authority, SSM, for all waste types.

## 11.3 Repository performance

SFR is designed to prevent, limit and delay releases of radionuclides in the waste both from the engineered and the geological barriers. The properties of the wastes, together with the properties of the waste containers and of the engineered barriers in the waste vaults, contribute to the safety by providing low water flow (low permeability) through the waste and a suitable chemical environment to reduce the mobility of the radionuclides. A sufficient fraction of the short-lived radionuclides decay to insignificant levels during an initial period of good retention. For longer times, degradation of the repository system must be considered. The amount of longer-lived radionuclides must hence be sufficiently limited so that the radiological consequence of the fraction of these radionuclides that is transported to the biosphere does not pose a risk.

### 11.3.1 Time-scales and waste types

In Section 2.3.1 a categorisation of radionuclides, based on their half-lives, was introduced:

- Short-lived radionuclides with a half-life less than 10 years.
- Short-lived radionuclides with a half-life longer than 10 years but less than 31 years. These radionuclides will decay to insignificant levels within a relatively short time period, i.e. about 10 half-lives of these short-lived radionuclides coincides with the time period for which institutional control, internationally, is foreseen to contribute to safety.
- Long-lived radionuclides with a half-life short enough to decay substantially during time periods of relevance for the design of the repository and/or the safety assessment. Time periods of relevance are for instance the time period when the shoreline passes the repository, the time period until a well for drinking water may be drilled into or downstream of the repository, the time period until the concrete barriers degrade substantially and lose their function, and the time period until permafrost reaches repository depth.
- Long-lived radionuclides with a half-life so long that they will not decay substantially during the overall time period of this assessment.

Figure 11-2 summarises some safety-related events in the evolution of the repository in relation to the decay of the key radionuclides.

Different radionuclides contribute to the total risk at different times. Based on activity and radiotoxicity, Ni-63 is one of the most important radionuclides. Because of its short half-life, Ni-63 will decay to insignificant levels during the time when the repository is covered by the sea. The low hydraulic gradient under the sea, resulting in low groundwater flow, means that significant amounts of Ni-63 cannot be transported to the biosphere.

Based on radiotoxicity, Am-241 is the single most important radionuclide. Am-241 is highly immobile under repository conditions, i.e. high pH and reducing conditions, which means that its contribution to the radiological risk is small. Since the half-life of Am-241 is relatively short, most of the inventory of this radionuclide has decayed after 1000 years when an intrusion well can be drilled. Therefore the potential impact of Am-241 from an intrusion well is limited.

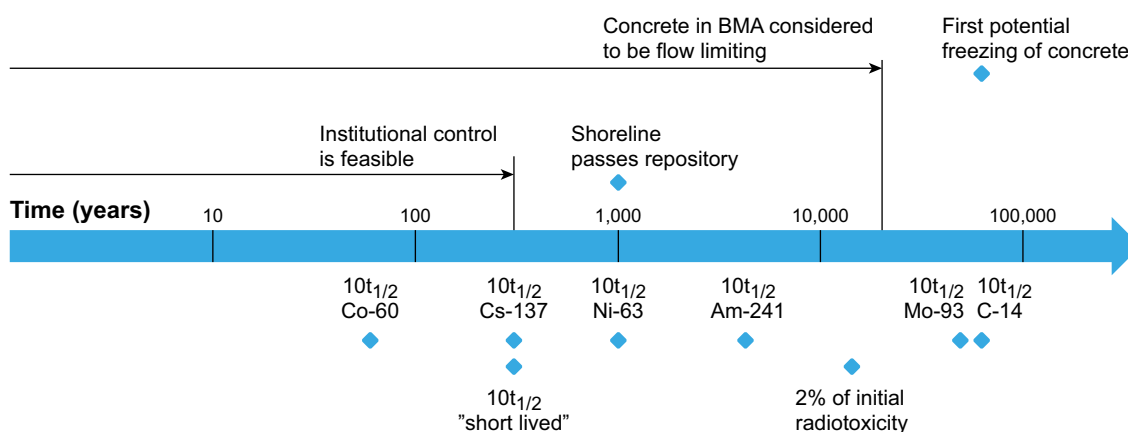
During the first 20,000 years, the inventory of Mo-93 and C-14 decreases significantly due to decay. The flow-limiting function of the concrete material in BMA will be maintained for at least this period, and longer for the silo. Thereafter, the possible contribution to radiological risk from these radionuclides is insignificant due to their radioactive decay. After 50,000 years, freezing of the concrete barriers in the repository may occur. Further, ice-sheet development cannot be excluded. At that time, the activity of radionuclides in the repository is completely dominated by the limited amount of long-lived radionuclides with a half-life so long that they will not decay substantially during the assessment period.

At the end of the assessment period (i.e. 100,000 years), all radionuclides are, if not below clearance levels, at least close to.

### 11.3.2 Arguments for the selected time-scale of the risk analysis

A 100,000 year assessment period was chosen based on the general advice to SSMFS 2008:37, see Section 2.2.1. The general advice requires that *“The arguments for the selected limitations of the risk analysis should be presented.”*

The radionuclide transport calculations and the estimated risk, presented in Chapter 10, show that an assessment time period of up to 100,000 years can be justified. The maximum radiological consequence is achieved within this time-period and the radiological risk, although cautiously handled, is below the risk criterion during the entire time period.



**Figure 11-2.** Safety-related events in the evolution of the SFR repository in relation to radioactive decay of the key radionuclides, i.e. those contributing most to radiological risk, in the safety assessment.  $10t_{1/2}$  denotes the time corresponding to 10 half-lives of the radionuclide, which means that less than 0.1% of the radioactivity at repository closure remains.



The contribution from long-lived radionuclides like Ni-59, uranium and its progeny is, although treated cautiously, below the risk criterion. At the end of the assessment period, the average concentration of Ni-59 in the waste, when only radioactive decay is taken into account, is below corresponding clearance levels. The contribution from uranium progeny to the total risk is not projected to increase significantly beyond 100,000 years. Thus the radiological consequence of the long-lived radionuclides beyond 100,000 years is not expected to exceed the maximum radiological consequence during the assessment period.

In the event of ice-sheet growth and decay above SFR, the repository system is affected to such a degree that it cannot be described and analysed in detail. Therefore, the event of ice-sheet development and the evaluation of the repository system thereafter are assessed in a simplified way in SR-PSU. These calculations show that the risk criterion is met also during the post-glacial phase.

### 11.3.3 Repository depth

The depth of the repository has been chosen to provide a stable environment and to isolate the waste from the biosphere. Based on experiences from the site investigations (SKB 2013e), a depth of 120 m, with favourable hydraulic properties of the bedrock, was chosen for the extension. As shown in the present assessment, the geochemical conditions are favourable and the hydraulic properties of the bedrock provide a low water flux. As shown in Chapter 10, the chosen depth is lower than the normal depth for water wells in the area. The radiological risk for the *intrusion wells scenario* is low and meets regulatory criteria.

As discussed in the reference evolution and in the scenario description for the *glaciation and post-glacial conditions scenario*, it cannot be excluded that permafrost may reach repository depth, or that future ice-sheet development may have a severe impact on the protective capability of the repository. The limitation on the amount of long-lived radionuclides ensures that regulatory requirements on protection of human health and the environment are met even after such events.

### 11.3.4 Barriers and their functions

The repository design includes a number of barriers. It is stated in SSMFS 2008:21 that:

*Safety after the closure of a repository shall be maintained through a system of passive barriers.*

Further, regarding barrier function SSMFS 2008:21 states that:

*The function of each barrier shall be to, in one or several ways, contribute to the containment and prevention or retention of dispersion of radioactive substances, either directly or indirectly by protecting other barriers in the barrier system.*

SSMFS 2008:21 also states that:

*A deficiency in any of the repository's barrier functions that is detected during the construction or operational surveillance of the repository, and that can lead to a deterioration in safety after closure in addition to that anticipated in the safety analysis report, shall be reported to the Swedish Radiation Safety Authority without unnecessary delay. The same applies if such a deficiency is suspected to occur or if it is suspected that such a deficiency may possibly occur in the future.*

The following section discusses the evolution of the repository system with specific emphasis on the barriers and their function.

To facilitate monitoring of barrier function, a clear definition of the barrier system is needed. The text below summarise the function and the estimated lifetime of the repository barriers in the current assessment. For how long the barrier function is estimated to be maintained varies depending on the type of barrier function (hydraulic, mechanical or chemical). For example, fractured concrete can serve as a sorption barrier, even if its hydraulic function is no longer maintained.

A summary of the barriers that are of importance for the long-term safety of the repository is presented in Table 11-1. The sub-sea siting, the rock and the plugs are common to all waste vaults.

**Table 11-1. Barriers contributing to the long-term safety of the SFR repository.**

Silo	1-2BMA	1-2BTF	1-5BLA	1BRT
Waste form	Waste form	Waste form (applies to ash drums)		RPV filled with grout
Concrete moulds	Concrete moulds	Concrete tanks		
Concrete structures <sup>1</sup> and grout outside packages	Concrete structures <sup>2</sup> and grout outside packages	Grout outside packages		Embedment of RPV in concrete
Bentonite				
Backfill material <sup>3</sup>	Backfill material <sup>3</sup>	Backfill material <sup>3</sup>		Backfill material <sup>3</sup>
Closure silo top				
Plugs <sup>4</sup>	Plugs <sup>4</sup>	Plugs <sup>4</sup>	Plugs <sup>4</sup>	Plugs <sup>4</sup>
Host rock	Host rock	Host rock	Host rock	Host rock
Sub-sea siting	Sub-sea siting	Sub-sea siting	Sub-sea siting	Sub-sea siting

<sup>1</sup> Bottom, walls and lids on shafts plus exterior silo wall.

<sup>2</sup> 1BMA: Floor, walls and lids on compartments. 2BMA: Caissons and lids.

<sup>3</sup> Includes bottom material on which the structure rests as well as backfill in waste vaults and tunnels.

<sup>4</sup> Plugs adjacent to waste vaults and plugs in tunnels.

### **Sub-sea siting**

The sea above SFR constitutes a barrier to future human intrusion during the submerged phase (up to 3000 AD). During that time, the activity of most radionuclides in the repository will decrease substantially due to their short half-lives. Under these circumstances drinking water wells in and downstream of the repository are deemed to be unlikely. Moreover, the low hydraulic gradient during the submerged period means that there will be no significant release of radionuclides from the repository. This is discussed in Chapters 6 and 7.

### **Rock**

The host rock provides an environment typified by low water flow, which limits concrete degradation and radionuclide transport. Results from flow modelling are presented in Odén et al. (2014) and Abarca et al. (2013), and conclusions from these studies are summarised in Chapter 6. The rock also provides a stable chemical environment, including anaerobic conditions which contribute to protecting reducing conditions at repository depth. Reducing conditions imply that iron corrodes only slowly and that the mobility of certain safety critical radionuclides (particularly radioisotopes of uranium) is low. Redox conditions at repository depth were analysed in Duro et al. (2012) and are summarised in Chapter 6. Finally, the rock is also a barrier to human intrusion, as is shown in the **FHA report**.

The barrier functions of the rock are considered to be maintained throughout the whole assessment period.

### **Plugs**

The plugs placed in the repository are mainly hydraulic barriers, but they may also have a chemical barrier function.

Plugs in the repository system cause redistribution of the flows through SFR so that the flows in the various waste vaults are limited. This limits radionuclide transport and delays concrete degradation. The importance of the plugs is to some extent dependent on the location of the waste vaults in relation to each other. Hydrogeological studies indicate that 2BMA, which is located far from the access tunnels and upstream from a regional hydrological perspective, is less sensitive to deficiencies in the function of the plugs than, for example, BRT.

The function of the plugs as hydraulic barriers is affected by degradation of the concrete and bentonite of which they are composed, as discussed in Chapter 6.

### **Silo**

The concrete structure of the silo, its interior and the bentonite around it have hydraulic, mechanical and chemical barrier functions.

The silo is made of *in-situ* cast concrete and is founded on a bed of sand and bentonite (see Figure 4-16). The concrete silo is also surrounded by bentonite, which limits the flow of water through the wastes within it. The function of the flow barrier is studied in Abarca et al. (2013). In the silo, the radioactive waste is deposited in a cylindrical concrete structure. Concrete walls divide the interior of the silo into disposal shafts. The waste in the silo is conditioned in cement, bitumen or concrete. The waste packages in the silo are continuously grouted during the operational phase. The entire concrete silo and its interior – including grout, concrete packaging and conditioned waste – serve as mechanical elements that resist the swelling pressure from water-saturated bentonite, the pressure from gas formation and the load from self-weight. The silo top seal is designed to release gas to avoid gas driven advection. In conjunction with closure, the top part of the silo cupola will be backfilled with macadam to protect against rock fallout. The bottom bed of sand and bentonite has primarily a mechanical function. The pH-buffering function of the concrete and the grout keeps gas production due to microbial activity and iron corrosion low. The choice of concrete as an engineering material also ensures good sorption properties.

The barrier functions of the silo are estimated to be maintained for the duration of the analysis, as discussed in Chapter 6.

### **1BMA and 2BMA**

1–2BMA and their interiors have hydraulic, mechanical and chemical barrier functions. Both 1BMA and 2BMA (Figure 4-6 and Figure 4-9) consists of concrete structures in which waste is deposited. The waste packages in 1BMA are grouted during the closure phase while the waste packages in 2BMA are grouted during the operational phase. During the closure phase, both waste vaults are back-filled.

The concrete structures, together with the grout and the waste packages, have a flow-limiting function. The concrete structures rests on a bed of macadam surrounded by crushed rock, and this combination forms a hydraulic cage that contributes to the hydraulic function of the vaults. The functioning of the flow barrier is studied in Abarca et al. (2013). The materials inside the concrete structure – grout, concrete waste packaging and waste form – are necessary to maintain the mechanical integrity of the structure. At closure, the waste vault will be backfilled with macadam to protect the concrete structure from rock fallout. The pH-buffering function of the concrete and the grout keeps gas production due to microbial activity and iron corrosion low. The choice of concrete as an engineering material provides good sorption properties.

The different aspects of the barrier function have different service lives. The long-term evolution of the flow-limiting ability of the concrete structure is associated with a transformation of cement minerals, and the flow-limiting function is maintained for at least 20,000 years (Höglund 2014 and Chapter 6). The mechanical and chemical functions are maintained for longer lengths of time (Cronstrand 2014 and Chapter 6 and 7). The impact of a more extensive degradation of the concrete barriers has been investigated in the *accelerated concrete degradation scenario*. In this scenario, the flow-limiting function of the concrete structure in 1BMA is taken to be diminished after 1,000 years. However, the flow-limiting function is still effective for 20,000 years, but to a lesser degree than in the main scenario. Beyond this time, the barriers are assumed to have the same hydraulic properties as the high permeability backfill (Figure 7-14).

### **1BTF and 2BTF**

1BTF and 2BTF (Figure 4-13) and their interiors have hydraulic, mechanical and chemical barrier functions.

Both steel drums and concrete tanks are deposited in 1BTF. The steel drums contain smaller drums with a content of ashes, and the space between the drums is filled with concrete. In 2BTF, only concrete tanks are deposited. The drums are grouted as they are emplaced during the operational phase, and the concrete tanks are grouted after operations are terminated. The space between the waste packages and between the waste package and the rock, is filled with grout, and a lid is cast on top of the grouted waste packages. The grout, the concrete waste packaging and the waste form (as it applies to ash drums) have a flow-limiting function. At the bottom is a bed of macadam, which is important for the hydraulic function of the repository. The function of the flow barrier is studied in Abarca et al. (2013) and is summarised in Chapter 6. All material is necessary to maintain the mechanical integrity of the vaults. At closure, each waste vault is backfilled with macadam to protect the concrete structure from rock fallout. The pH-buffering function of the concrete and the grout keeps gas production due to microbial activity and iron corrosion low. The choice of concrete as an engineering material provides good sorption.

The different aspects of the barrier function have different service lives. The flow-limiting function of the barrier is maintained for 1,000–10,000 years (**Data report** and Chapter 6), whereas the mechanical and chemical functions are maintained for longer (Cronstrand 2014 and Chapter 6).

## **BRT**

BRT and its interior have mechanical and chemical barrier functions.

Reactor pressure vessels (RPVs) are deposited in the BRT waste vault and before repository closure they are filled with grout, after which they are embedded in concrete. The choice of concrete as an engineering material provides good sorption. The function of the concrete is also to maintain high pH conditions in order to limit corrosion of steel. Limited corrosion delays the release of the surface contamination on the inside of the RPVs, as well as the release of neutron activation products. At closure, the waste vault is backfilled with macadam to protect the concrete structure from rock fallout.

The mechanical function is maintained for the duration of the assessment period and the chemical function is conservatively assumed to be maintained until 22,000 AD only (Cronstrand 2014 and Chapter 6 and 7).

## **1–5BLA**

Barriers in 1–5BLA are plugs, the rock and the sea as an intrusion barrier.

## **11.4 The current assessment**

As mentioned in Chapter 2, assessment of long-term safety requires a description of the evolution of the repository system and its environs. The future state of the repository system will depend on:

- **Initial state of the repository system.** The initial state is defined as the state of the repository system at closure. In order to describe the initial state, the reference design and evolution of the repository system during the operational phase need to be considered.
- **External conditions acting on the repository system after closure.** External processes include climate and climate-related processes, for example permafrost and shoreline displacement and the current process of global warming. Future human actions may also affect the future state of the repository.
- **Internal processes within the repository system.** Internal processes include thermal, hydraulic, mechanical and chemical processes that act in the repository system. Internal processes include, for example, groundwater flow and chemical degradation affecting the engineered barriers. Another example is production of gas as a result of corrosion of metals.

Based on this, the **evolution of the repository system** is estimated. By combining the evolution of the repository system with an analysis of radionuclide release and transport, and with an assessment of radiation doses to humans and other biota, **radiological risks** to humans and radiological impacts on the environment can be estimated. The analysis of exposure pathways identified a set of possible future human populations, based on historical and present land-use and consumption data. These populations have been used as bounding cases for the most exposed group.

The current safety assessment is briefly described in the following, with an emphasis on significant improvements as compared to previous safety assessments. Further, the confidence in the results of the safety assessment and uncertainties in the results are discussed.

### **11.4.1 Initial state**

The initial state is the point of departure for the analysis of the repository system's performance after closure and it defines the expected state immediately after closure. The initial state of repository and its environs is based on realistic or pessimistic assumptions concerning the conditions at closure. For SFR 1 these assumptions are, as far as possible, based on verified and documented properties of disposed wastes and installed repository barriers. In addition, prognosis for additional waste and an assessment

of changes in the properties up to the time of closure of the repository are considered. The initial state of SFR 3 is based on the reference design for this part (Layout 1.5) and the present prognosis for future wastes to be disposed. The initial state is presented in the **Initial state report** and in Chapter 4. In order to assess the long-term safety, it has in some cases been necessary to make the description more detailed than that provided in the background reports. This is done by making a number of assumptions concerning the initial state and the evolution of the repository system (see further Section 11.5.1)

#### 11.4.2 External conditions

External conditions are divided into the three categories "climate and climate-related issues", "large-scale geological processes and effects" and "future human actions (FHAs)". The most important part of the description of external conditions is the formulation of well-founded future evolutions of the climate and climate-related issues. In the safety assessment, this is handled by the formulation of four alternative climate evolutions, or climate cases (**Climate report**), which are included in the assessment.

A dedicated analysis of the earliest potential timing of future permafrost development at the Forsmark site, through climate- and permafrost modelling, has been included in the SR-PSU safety assessment. This is of importance given the SFR repository characteristics, including its shallow depth and concrete barriers.

Future human actions are analysed by first identifying FEPs relevant at the site. The FEPs are then used to set up stylised FHA scenarios of which some are analysed quantitatively and others qualitatively. The FHA methodology and scenarios are described in the **FHA report** and the stylised scenarios are described in Chapter 7.

#### 11.4.3 Internal processes

A site descriptive model has been established for the area. The site descriptive model, SDM-PSU (SKB 2013e), is a cross-disciplinary model based on a large number of new investigation boreholes, fracture mapping and hydraulic tests. The investigations resulted in a large increase in the amount of site data compared with what was available for SAR-08. Parameter values used in the current assessment are better justified than those used previously. Furthermore, the flow modelling tool used in the present analysis, DarcyTools, better represents the rock structures and their properties compared with the modelling tool used earlier for SFR.

A detailed model of water flow in the waste vaults and through the waste that takes data directly from the regional hydrogeological model has been developed (Abarca et al. 2013). In this model, the geometry of individual compartments/caissons of the BMA vaults is included and the silo model includes a representation of individual shafts.

Moreover, in the present safety assessment, concrete degradation has been handled in a more systematic manner than in the previous assessments (Chapter 6 and Höglund 2014).

Sorption of radionuclides has been shown to be the main mechanisms controlling retardation in the repository. Sorption occurs mainly on the cementitious materials in barriers and waste packages. The sorption depends on the amount of available concrete surfaces, but also on the chemical composition of the water in the repository. The importance of sorption is strongly related to the chemical characteristics of individual radionuclides, including their redox state. The redox state calculated by Duro et al. (2012) hence gives a valuable background for the choice of partitioning coefficients for sorption.

Waste consisting of organic materials degrades into products that can form complexes with some radionuclides and thereby reduce the sorption of those radionuclides on solid surfaces. It is therefore important to keep the amount of complexing agents low. The degradation of cellulose results in ISA (isosaccharinate), which is regarded to be the most significant organic complexing agent in the repository (**Waste process report**). As the degradation of cellulose proceeds, the concentration of ISA will slowly increase (Keith-Roach et al. 2014).

Since the last safety assessment (SAR-08), a number of improvements have been made to the surface system analysis, e.g. a new digital elevation model and a regolith depth model have been developed. Moreover, the radionuclide transport model has been enhanced to better represent the transport and accumulation of C-14 in the surface systems.

#### 11.4.4 Evolution of the repository system

The reference evolution (see Chapter 6), defined as a range of most probable future evolutions, was used to describe the evolution of the repository system. The reference evolution is based on the initial state together with processes and events relevant for the long-term safety of the SFR repository.

Based on the reference evolution, scenarios of relevance for the evolution of the repository system and for the evaluation of long-term safety have been defined (Chapter 7). The radiological consequence of the different scenarios are analysed in Chapter 7 and Chapter 9.

#### 11.4.5 Estimating radiological risk

To assess radiological consequences, the scenarios are evaluated with the aid of calculation cases that are analysed with mathematical models. Radionuclide transport from the waste through the repository and the rock to the biosphere is calculated, and, the doses to humans and dose rates to biota that can arise from exposure to repository-derived radionuclides are evaluated.

The radiological risk is estimated for the main scenario and for the less probable scenarios. The risk for a scenario is calculated by multiplying the probability of the scenario by the calculated dose consequence. The estimated risk is compared with SSM's risk criterion. The main scenario and the less probable scenarios are included in the summation of the total risk for the repository.

#### 11.4.6 Confidence in results

In Chapter 10, total risk and radiological risk for the different scenarios are presented. The estimated radiological risk is based on several cautious assumptions. Since the degree of pessimism is not necessarily the same for the different scenarios, waste vaults, radionuclides or time periods, comparisons of the risk estimates may be misleading, and far-reaching conclusions should not be made solely based on these results. The confidence in the overall conclusion that the repository complies with the regulatory risk criterion is however high.

The highest contributions to the total risk are from the *main scenario* and the *intrusion wells scenario* for 1BLA. Combining the *main scenario* with less probable scenarios gives information on the sensitivity of the *main scenario* to uncertainties in the evolution. All less probable scenarios except the *earthquake scenario*, the *high inventory scenario*, the *wells downstream of the repository* and the *intrusion wells scenario* were assigned the same probability, (0.1), although the real probability is assumed to be considerably lower. However, the radiological risk for this subset of the less probable scenarios would comply with the risk criterion even if their probability was set to 1.

In the assessment, it is shown that the estimated risk is dependent on exposed group, although differences between groups are relatively small and generally restricted to a factor 2 to 3 (except for the hunters and gatherers for which the doses are much smaller). When estimating the total risk, the group exposed to the highest dose is always used, and this adds further to the confidence in the overall results of the safety assessment.

#### **Bounding cases**

The confidence in the overall conclusion that the repository complies with the regulatory risk criterion is high. In addition, residual scenarios provide some understanding of the hypothetical maximum radiological consequence. In these residual scenarios, the consequences of disregarding transport resistance in the near- and far-field, or of assuming that the engineered barriers do not perform as intended, are examined. In order to study this, three residual scenarios were analysed; *no sorption in the repository scenario*, *no sorption in the bedrock scenario* and *high water flow in the repository scenario*. In addition, a residual scenario where the effect of changing redox condition, the *changed repository redox conditions in SFR 1 scenario*, was studied.

The scenarios that give the highest doses of these four residual scenarios are the *no sorption in the repository* and the *high water flow in the repository scenario*. In the first, the effect of the sorption barriers is studied, whereas the latter studies the effect of the flow barriers. In both of these scenarios,

the retention capability of the repository is shown to contribute significantly to long-term safety. Even in these bounding cases, which represent extreme and highly unlikely situations, the annual dose is only slightly higher than the regulatory risk criterion (less than a factor 3).

#### ***Agreement with SAR-08***

The results presented and the conclusions drawn, largely agree with the results from SKB's most recent, previous safety assessment of SFR, SAR-08. The contribution from C-14 to the total risk has decreased, whereas the contribution from some other radionuclides, e.g. Mo-93 and U-238, has increased. The main reason for this is a different handling of the associated uncertainties and pessimisms in the model, together with a different radionuclide inventory in the decommissioning wastes.

#### **11.4.7 Uncertainties**

In the discussion of confidence it is important to consider the question of the completeness of the assessment and how uncertainties have been handled. In brief, the uncertainties are dependent upon scenario selection, the ability of the models to describe processes, and parameter values. These uncertainties are discussed in detail in Section 2.6.2 and are summarised below.

#### ***Completeness in identification of FEPs and scenario selection***

The handling of FEPs in SR-PSU has in principle followed the same procedure as that established for the handling of FEPs in SKB's most recent safety assessment, SR-Site. Three sources were used to identify relevant features, events and processes influencing the long-term safety of the SFR repository. These are the SR-Site FEP catalogue, interaction matrices developed for SFR 1 and the Project FEPs in version 2.1 of the NEA FEP database. Project FEPs are FEPs identified within safety assessments undertaken by various national organisations. In addition, the sets of FEPs for two near-surface facilities were reviewed, the review of these did however not lead to any changes in the FEP catalogue.

#### ***Conceptual uncertainty***

The term "conceptual uncertainty" is used for uncertainties that are due to the fact that the fundamental understanding of a process is not complete, or to the fact that a mathematical model does not correctly or fully describe a process. The aim has been to describe all processes as realistically as possible. But where realistic assumptions cannot be supported, assumptions are made so that the consequences of unfavourable processes are overestimated and conversely so that the potentially positive consequences of favourable processes are underestimated or neglected.

#### ***Quantification of initial state and uncertainties in input data***

In general, data have been chosen cautiously or realistically so that the risk from the repository is not underestimated. However, in order to better understand the repository system, a certain degree of realism is needed. For certain parameters, uncertainties have, where possible, been handled by means of a probabilistic approach in the models for radionuclide transport and dose calculations. This applies, for example, to radionuclide sorption coefficients for different materials, flow parameters and parameters for describing accumulation and uptake in the biosphere. Furthermore, residual scenarios have been considered that shed light on the performance of the engineered barriers (concrete and bentonite) and the geosphere.

### **11.5 Requirements and the iterative process**

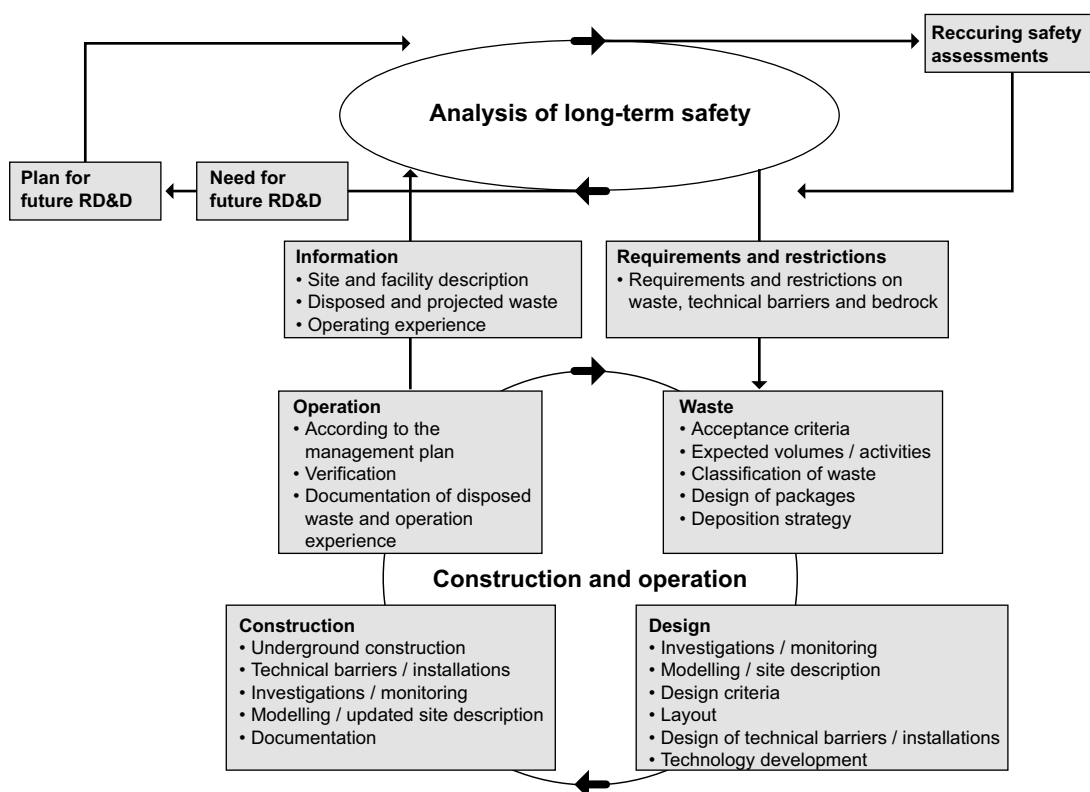
The requirements on and description of the future wastes will continue to be refined and further adapted to the chosen design based on the requirements that emerge from, among others, this and subsequent assessments of long-term safety. The conclusions regarding fulfilment of radiological risk requirements might not be affected, but in order to reduce uncertainties, the properties of the wastes may need to be described better in subsequent assessments. By reducing the uncertainties, the

degree of pessimism in the assessment can be reduced and requirements from the safety assessment on the repository system, the wastes and facility design can be reconsidered. Figure 11-3 illustrates the role of the analysis of long-term safety in this iterative process.

The regulations require that the best available technique (BAT) is used and that siting, design, construction and operation of the repository and appurtenant system components are selected to prevent, limit and retard releases from both engineered and geological barriers as far as is reasonably achievable (SSMFS 2008:21). What is considered reasonable is discussed in the appendix on best available technique (SKBdoc 1415420) that comprises a part of the application for a licence to extend SFR. Factors of importance for the retention capacity include what amounts of cellulose can be considered reasonable to dispose, what amounts of gas-producing materials can be permitted without damage to the barriers, waste allocation to the different disposal vaults, etc. In order for the repository to be regarded as a repository for short-lived wastes, requirements must also be stipulated on what quantities of long-lived radionuclides, associated with wastes that contain principally short-lived radionuclides, can be accepted in the repository. Besides a discussion regarding best available technique and reasonableness, assumptions made in the assessment can result in requirements on design and on the waste.

The present document, together with the analysis of operational safety, constitute the first preliminary safety analysis report (F-PSAR) for the extended SFR. Following the present assessment, a preliminary safety assessment, PSAR, will be undertaken followed by a safety assessment, SAR, for the operation of the repository. For an operational repository, the safety analysis report has, according to the SSM regulations SSMFS 2008:1, to be updated at least every tenth year as part of a periodic safety review.

Each new safety assessment rests on conclusions from the previous assessment, experiences gained from operating the repository and on results from new R&D activities. Some of the work needed for a coming safety assessment can be done in conjunction with the safety assessment project, whereas some activities may take longer and need to be included in the RD&D programme. This continues throughout the operational life of the repository. Prior to closure, the safety assessment shall be renewed and subjected to a safety review (SSMFS 2008:1).



**Figure 11-3.** The iterative process including reiterated safety assessments. Construction and operation of the SFR facility affects the basis for the analyses of the operational and long-term safety. The outcome of the analyses may define new or modified requirements on the design and on the waste. This in turn affects the construction and operation of the facility.



### 11.5.1 Analysis of long-term safety

The current assessment is based on information regarding design, construction operation and waste, see Figure 1-1. As presented in Section 2.3.3, a number of assumptions have been necessary to make in the analysis of long-term safety. Based on these assumptions, requirements and restrictions may need to be formulated in the next iteration.

Assumptions related to the initial state in the present assessment are:

- It has been necessary in the radionuclide transport calculations to make assumptions about how activity is distributed between different shafts/compartments in the waste vaults.
- Surface hydrology calculations have been done for the area as it looks today; the possible impacts of a rock heap and filling of a bay north of SFR have not been analysed. This assumption is not considered to have any significant impact on the conclusions of the assessment, but its implications should nevertheless be investigated further.
- The initial state is based on Layout 1.5, which is not the final one. Because of the small differences between Layout 1.5 and final Layout 2.0, this is not considered to have any impact on the conclusions of the assessment.
- Further work, such as that reported in the Closure plan (SKBdoc 1358612), may need to be done on 1BMA in order to reconcile the stated properties with the initial state that is presented in the **Initial state report** and summarised in Chapter 4.
- The radionuclide inventory in SFR has been estimated based on various nuclide-specific measurements, calculations and correlations with key nuclides. In addition to the wastes currently deposited in SFR, the total radionuclide inventory at closure will include wastes from both continued operation and decommissioning of the Swedish nuclear power plants and other nuclear facilities. Since a large portion of the wastes has not yet been produced, the estimates are associated with a number of uncertainties. Identified uncertainties are described in the inventory report (SKB 2013a).
- The inventory of the legacy-waste S.14 in 1BLA is taken from the TRIUMF database. There are uncertainties associated with the composition of this inventory, and additional work to clarify the composition of the S.14-waste has started.

Assumptions regarding internal processes or evolution of the repository system in the present assessment are:

- The load exerted by swelling waste will not damage the barriers in 1BMA and 2BMA.
- The quantity of reactive metals is so low that the barriers are not damaged by gas.
- The pH in BMA is maintained at such a level that microbial degradation of C-14-containing waste is kept so low that release of C-14 as methane gas will not be a dominant transport pathway (see Appendix I).
- The quantity of cellulose in the waste is limited. The reason for this is that the quantity of cellulose should not give rise to such high concentrations of the complexing agent isosaccharinate (ISA) that it adversely affects the sorption of radionuclides (see Appendix I).

In coming design steps, requirements on waste and design may be reformulated to fit these assumptions (see further Section 11.5.2). When it comes to external conditions, no assumptions have been made that will result in requirements or restrictions on waste, operation, design and construction.

### 11.5.2 Requirements and restrictions

As a result of the safety assessment, a number of requirements and constraints on the wastes and the design, construction and operation of the repository have been identified.

The basis for the present safety assessment is the description of the initial state, which is presented in the **Initial state report** and summarised in Chapter 4. The description contains some uncertainties in design, construction and operation of the repository, as well as in the composition of the wastes.

The conclusions of the analysis are valid for the initial state under the assumed conditions. Some of the assumptions presented under the subheading “Information used in the present assessment” in Section 2.3.3 may therefore result in additional requirements on the repository and its components.

### **Waste**

Waste to be deposited in SFR must meet special waste acceptance criteria (WAC) that regulate the properties of the waste. Decommissioning waste deemed suitable for disposal in SFR is presented, along with descriptions of deposited operational waste and predictions of future waste quantities, in an inventory report (SKB 2013a). The wastes on which the safety assessment is based are presented in Chapter 4 and in the **Initial state report**.

Preliminary WAC for the extended SFR, based on existing WAC for the existing SFR, have been formulated as a basis for the application for the extension of SFR (SKBdoc 1368638). These preliminary WAC have, together with the properties of existing wastes, served as a point of departure for technology development, but WAC have been and will also in the future be affected by the results of the long-term safety assessment and ongoing technology development, where technical designs for barrier structures and repository closure will be stipulated in increasing detail during the coming years. It is therefore to be expected that WAC will change over time as knowledge is gained regarding the waste and the final repository system. Areas where continued work and possible changes in preliminary WAC can be expected are chemical reactivity (e.g. in relation to complexing agents), gas evolution and inner mechanical stability (swelling and voids).

### **Design**

The description of the initial state is based on Layout 1.5. After Layout 1.5, the repository design has been further refined, resulting in a Layout 2.0, in which the dimensions of certain waste vaults have been adjusted and the bay north of the existing SFR has been filled in. These assumptions are not considered to affect the conclusions of the assessment, but their implications should nevertheless be further investigated.

The purpose of the engineered barriers in the SFR repository is to prevent, limit and delay releases of radionuclides to the surrounding environs. Depending on the properties of the waste, different requirements are made on the choice of barriers. In order for the engineered barriers to meet stipulated requirements on long-term function, care must be taken in the selection of materials and methods for the design and construction of the engineered structures.

One specific requirement is the need to maintain high pH in the waste form in order to minimise microbial activity, especially methanogenes, in the repository. Figure 7-9 presents a summary of the modelled pH regime for each waste vault. The requirement is of main concern for BMA and the silo, where radioactive carbon (C-14) otherwise might be transformed to methane (Neretnieks and Moreno 2014) that could easily be transported up to the biosphere, causing radiological risks to humans and other biota.

### **Construction**

Requirements on construction, for instance the use of rock support, the choice between different materials, and situations where special precautions need to be taken or special procedures need to be used during blasting, need to be further specified.

### **Operation**

In the present assessment, a number of assumptions on future disposal strategy have been made, resulting in the inventory given in the **Initial state report** that is summarised in Chapter 4. These assumptions are necessary for the assessment, but the degree to which alternative disposal strategies would affect the results has not yet been investigated.

### 11.5.3 Need for further R&D

The safety assessment has revealed research areas that will be prioritised in the coming years to further reduce the conservatism in future long-term safety assessment projects. Some of these areas are specific to the SFR facility, whereas others can be relevant for both SFR and SFL. Some areas, especially questions related to the bedrock and the biosphere, are of importance also to the repository for spent nuclear fuel. The previously planned future work related to the long-term safety of SFR is described in the RD&D programme (SKB 2013d). A number of areas for which additional research efforts might contribute to reduce uncertainties in future safety assessments have been identified in SR-PSU. These activities are compiled below and will be considered in the coming RD&D programme 2016.

#### ***R&D related to waste form and packaging, engineered barriers and geosphere***

Activities/processes in the waste form and waste packaging, in the engineered barriers and in the geosphere, where additional research could help to reduce the conservatism in the safety case, have been identified. These are compiled below in Table 11-2, in the same form as in the Process Tables in Appendix F. The table is followed by a short motivation for, and description of, each additional research effort. A number of research areas are also presented for the biosphere and for climate issues.

#### **1. Inventory**

SKB is continuously evaluating the methods used to determine the amount of radionuclides in the waste categories that are or will be disposed of in SFR. Special effort is focused on the so called “hard to measure” nuclides; most often the long-lived beta-emitters, e.g. C-14, Cl-36, Tc-99, etc. These categories of nuclides are in many cases contributing significantly to the long-term risk. As measurements of these types of nuclides are almost impossible to perform directly on the waste, the radioactivity levels of these nuclides are determined by indirect methods. However within these indirect methods various assumptions are made that lead to uncertainties of the radioactivity content in the waste. Extra effort is needed to reduce the uncertainty factors. In the SFR safety reports; SAFE 2001 and SAR-08, some of the identified nuclides that SKB has studied further are e.g. C-14, I-129 and Tc-99. From the present safety analysis, SR-PSU, Se-79 and Mo-93 are nuclides identified that need further studies in order to reduce the uncertainty factor.

**Table 11-2. Activities/processes in the waste form and packaging, engineered barriers and geosphere for which additional research efforts might contribute to reduce uncertainties in future safety assessments. The index after the activity/process refers to following text where the motivation for and description of planned research efforts are given.**

Type of Activity/Process	Waste form and packaging	Engineered barriers	Geosphere
Initial state	Inventory <sup>1</sup>		
<b>Radiation-related processes</b>			
<b>Thermal processes</b>			
<b>Hydraulic processes</b>			
<b>Mechanical processes</b>	Pressure from swelling waste <sup>2,3</sup>	Pressure from swelling waste <sup>2,3</sup> Self-healing of bentonite after piping <sup>5</sup>	
<b>Chemical processes</b>	Degradation of organic materials <sup>4</sup> Microbial processes <sup>4</sup>  Metal corrosion <sup>3</sup> Gas formation <sup>4</sup>	Concrete degradation <sup>6</sup> Montmorillonite transformation/ion exchange <sup>7</sup> Concrete–bentonite interactions <sup>8</sup> Salt enrichment <sup>9</sup>	
<b>Radionuclide transport</b>			Radionuclide transport in the water phase <sup>10</sup>

## 2. Swelling waste

Evaporator concentrate occurs in some waste types in BMA. The concentrate consists of various salts that are dried at high temperature in the production of this particular waste type (denoted F.17). There is a thermodynamic driving force for these salts to rehydrate when the repository is re-saturated. This process implies that the salts will increase their molar volume, with the risk that the waste form swells. Similarly, dried ion-exchange resins which are conditioned in bitumen can swell when the repository re-saturates. For the present safety case, swelling waste in the silo is handled by ensuring expansion volume when grouting the waste and by the method for closing the repository. For 1–2BMA, it is assumed that swelling waste will not damage the grout and the barriers, and this will be ensured by the formulation of WAC. To reduce the uncertainties in future safety assessments, investigations of the swelling properties of waste forms containing ion-exchange resins and/or evaporator concentrate are planned.

## 3. Corrosion products

Iron is present in large amounts in SFR, both as metal parts and as packing of certain waste types. Steel packing exists as either steel drums or steel moulds. Most common is packing made of carbon steel. Stainless steel also occurs, but to a lesser extent. When elemental iron, Fe(0), corrodes in an anoxic environment, the corrosion product magnetite, Fe<sub>3</sub>O<sub>4</sub>, is produced. It has a larger molar volume than the original material, which implies that the corrosion of the steel packing can affect the integrity of the surrounding concrete in BMA and in the silo, with potential cracking of concrete barriers as a result. Confirmative calculations indicate that the internal walls in shafts containing bitumen waste could be fractured, but that the silo wall will be unaffected. SKB intends to conduct further studies related to how corrosion products may influence the concrete barriers, as well as to the mechanical consequences of corrosion products arising in concrete barriers. The results should reduce uncertainties in how the corrosion products may affect repository performance.

## 4. Gas formation

Wastes containing reactive metals such as Zn(0) and Al(0) cause rapid gas formation when they corrode in high pH environment. The internal gas pressure created in the barrier structure, where the waste is placed, may affect the integrity of the barrier construction in the long-term due to the internal mechanical loads. Another process that potentially may cause harmful gas build-up, especially in BMA, is microbial degradation of organic materials, such as cellulose, through methanogenesis.

The goal is to keep the amount of reactive metals at a low level and to create unfavourable conditions for microbial degradation, in order to restrict intensive gas formation. In the present assessment, requirements on high pH and low organic content are formulated. Further studies will increase the understanding and predict the future pH development in different parts of the repository and also how different pH conditions will affect gas production through methanogenesis. Furthermore, a permeable grout, with properties adapted to the expected gas production, will be tested and evaluated.

## 5. Self-healing of the bentonite

A finite element calculation of the self-healing (after an ice-lens formation) of a spherical void with the radius 0.5 m, which would represent severe damage to the bentonite caused by piping and erosion, has been done (Cronstrand 2014). Although the results cannot be used without reservations, they indicate that the bentonite would be fairly unaffected close to the concrete silo, which means that the sealing function would remain effective. This process should however be given further attention, since the self-sealing ability is crucial and both model capabilities and material data relevant to the silo bentonite are somewhat lacking.

## 6. Chemical processes in and hydraulic properties of degrading concrete

The relation between chemical degradation and hydraulic conductivity of concrete will be further investigated, in particular with respect to chemical processes in cracks where the water flow and water composition may vary locally. Formation of expansive minerals such as ettringite (Ca<sub>6</sub>Al<sub>2</sub>(SO<sub>4</sub>)<sub>3</sub>(OH)<sub>12</sub> · 26H<sub>2</sub>O) and thaumasite (Ca<sub>3</sub>Si(OH)<sub>6</sub>(CO<sub>3</sub>)(SO<sub>4</sub>) · 12H<sub>2</sub>O) may potentially lead to cracking of the concrete and increased hydraulic conductivity. Dissolution, precipitation and recrystallisation may, on the other hand, will lead to clogging of cracks in the concrete, which in turn

will lead to decreased hydraulic conductivity. Dissolution, precipitation and recrystallisation in the backfill can also lead to changes in hydraulic properties of the backfill. In the present assessment, pessimistic assumptions concerning the hydraulic properties of concrete due to concrete degradation have been used. Further research will improve the understanding of chemical processes in the concrete may affect the hydraulic properties of degrading concrete.

### **7. Ion-exchange in the bentonite**

Ion-exchange in the bentonite will most likely result in a strong reduction in the swelling pressure of the bentonite (as is the case for MX-80 bentonite). Analysis of verified laboratory data on MX-80 bentonite, together with preliminary laboratory investigations of the GEKO/QI bentonite emplaced in SFR, suggests that a reduction in the swelling pressure by a factor of two to five is realistic.

Additional laboratory experiments are ongoing to verify the preliminary data. These studies should give sufficient understanding of the consequences of ion-exchange in the bentonite.

### **8. Interactions between bentonite and concrete**

Bentonite clay has in general been regarded as incompatible with concrete in repository design, due to the effects of the highly alkaline water released from concrete. The modelling performed (Cronstrand 2014) indicates that as long as the concrete wall is fairly intact, the degradation proceeds slowly. Fractured concrete on the other hand, resulting in extensive exposure to fresh cement pore water, can have a significant corrosive effect on the montmorillonite. The major uncertainties can be traced to the selected thermodynamic database, the growth kinetics of newly formed phases and unknown factors that may reduce the swelling pressure and thereby allow local flow through the bentonite barrier. These areas will be studied further to add confidence to the assessment.

### **9. Salt enrichment**

BMA contains wastes with soluble salts. This implies a risk of elevated salt concentrations in nearby concrete barriers which can cause the formation of secondary phases like ettringite and thaumasite. However, these salts will first react with the available concrete and cement that exist in the waste domain, which will significantly reduce the impact of salt on the surrounding concrete barriers. The interaction between the waste and concrete barriers analysed in SR-PSU is based on the pessimistic assumption that the waste domain can be treated as a stirred tank. This assumption will be evaluated using models with increasing levels of detail.

### **10. Transport of U-238 in the geosphere**

Migration processes of natural uranium in the upper parts of the geosphere are of importance for the evaluation of risk from SFR. In the present assessment, the transport of uranium is treated pessimistically. The ongoing studies on the geochemistry of natural uranium in the Forsmark area will be continued, and will provide additional knowledge to be included in future safety assessments of SFR.

### ***R&D related to the biosphere and to the climate development***

- **Dispersal of C-14 in aquatic ecosystems and cycling and accumulation of Cl-36, Mo-93 and U-238 in surface systems**

Supplementary field studies and modelling are planned to investigate the potential importance of the dispersal of C-14 in lakes in the Forsmark area, and also to investigate the importance of dissolved organic matter (DOM) and colloids in the cycling and transport of C-14. In addition to C-14, studies are planned to better describe the cycling of chlorine and accumulation of Cl-36, Mo-93 and U-238 in surface environments. Information from these studies will be used to reduce the degree of pessimism in the development of the radionuclide transport model.

- **Radionuclide transport and biological uptake in surface systems**

There is a need to increase the knowledge about dominant fluxes of organic matter, nutrients and water within the different ecosystems, and the factors that regulate these fluxes, in order to update the representation of biological uptake in the radionuclide modelling. This can replace or supplement the concentration ratios (CR values) for organisms, with mechanistic models for biological uptake.

- **Projected future climate and shore-level evolution**

The climate cases used in the SR-PSU safety assessment were designed to cover the uncertainty range associated with future climate development based on current scientific knowledge. Future climate evolution is however very uncertain and is a field of intense ongoing research in the scientific community. Uncertainties in the climate evolution are strongly related to uncertainties in the sea-level evolution. The scientific literature addressing future climate will therefore be followed and used to re-evaluate the climate developments and shore-level evolution used in SR-PSU.

Moreover, the potential for permafrost in Forsmark in the next 60,000 years was analysed in SR-PSU utilising a combination of climate modelling and numerical permafrost modelling. The same numerical permafrost model was also used to describe the permafrost evolution in the Weichselian glacial cycle climate case. This model will be further evaluated by application of the model to the study area for the Greenland Analogue Project (GAP) on western Greenland.

## 12 References

SKB's (Svensk Kärnbränslehantering AB) publications can be found at [www.skb.se/publications](http://www.skb.se/publications). References to SKB's unpublished documents are listed separately at the end of the reference list. Unpublished documents will be submitted upon request to [document@skb.se](mailto:document@skb.se).

### **References with abbreviated names**

**Main report, 2014.** Safety analysis for SFR. Long-term safety. Main report for the safety assessment SR-PSU. SKB TR-14-01, Svensk Kärnbränslehantering AB.

**Barrier process report, 2014.** Engineered barrier process report for the safety assessment SR-PSU. SKB TR-14-04, Svensk Kärnbränslehantering AB.

**Biosphere synthesis report, 2014.** Biosphere synthesis report for the safety assessment SR-PSU. SKB TR-14-06, Svensk Kärnbränslehantering AB.

**Climate report, 2014.** Climate and climate related issues for the safety assessment SR-PSU. SKB TR-13-05, Svensk Kärnbränslehantering AB.

**Data report, 2014.** Data report for the for the safety assessment SR-PSU. TR-14-10, Svensk Kärnbränslehantering AB.

**FEP report, 2014.** FEP report for the safety assessment SR-PSU. SKB TR-14-07, Svensk Kärnbränslehantering AB.

**FHA report, 2014.** Handling of future human actions in the safety assessment SR-PSU. SKB TR-14-08, Svensk Kärnbränslehantering AB.

**Geosphere process report, 2014.** Geosphere process report for the safety assessment SR-PSU. SKB TR-14-05, Svensk Kärnbränslehantering AB.

**Initial state report, 2014.** Initial state report for the safety assessment SR-PSU. SKB TR-14-02, Svensk Kärnbränslehantering AB.

**Input data report, 2014.** Input data report for the safety assessment SR-PSU. SKB TR-14-12, Svensk Kärnbränslehantering AB.

**Model summary report, 2014.** Model summary report for the safety assessment SR-PSU. SKB TR-14-11, Svensk Kärnbränslehantering AB.

**Radionuclide transport report, 2014.** Radionuclide transport and dose calculations for the safety assessment SR-PSU. SKB TR-14-09, Svensk Kärnbränslehantering AB.

**Waste process report, 2014.** Waste process report for the safety assessment SR-PSU. SKB TR-14-03, Svensk Kärnbränslehantering AB.

### **Other references**

**Abarca E, Idiart A, de Vries L M, Silva O, Molinero J, von Schenck H, 2013.** Flow modelling on the repository scale for the safety assessment SR-PSU. SKB TR-13-08, Svensk Kärnbränslehantering AB.

**Abarca E, Silva O, Idiart A, Nardi A, Font J, Molinero J, 2014.** Flow and transport modelling on the vault scale. Supporting calculations for the safety assessment SR-PSU. SKB R-14-14, Svensk Kärnbränslehantering AB.

**Allard B, Persson G, 1985.** Organic complexing agents in low and medium level radioactive waste. Nagra Technical Report NTB 85-19, Nagra, Switzerland.

**Allard B, Dario M, Borén H, Torstenfelt B, Puigdomenech I, Johansson C, 2002.** Karboxylatjonbyttarmassans egenskaper. SKB R-02-40, Svensk Kärnbränslehantering AB. (In Swedish.)

**Almkvist L, Gordon A, 2007.** Low and intermediate level waste in SFR 1. Reference waste inventory 2007. SKB R-07-17, Svensk Kärnbränslehantering AB.

**Andersson E (ed), 2010.** The limnic ecosystems at Forsmark and Laxemar-Simpevarp. SKB TR-10-02, Svensk Kärnbränslehantering AB.

- Andersson E, Aquilonius K, Sivars Becker L, Borgiel M, 2011.** Site investigation SFR. Vegetation in streams in the Forsmark area. SKB P-11-18, Svensk Kärnbränslehantering AB.
- Aquilonius K (ed), 2010.** The marine ecosystems at Forsmark and Laxemar-Simpevarp. SR-Site Biosphere. SKB TR-10-03, Svensk Kärnbränslehantering AB.
- Archer D, Eby M, Brovkin V, Ridgwell A, Cao L, Mikolajewicz U, Caldeira K, Matsumoto K, Munhoven G, Montenegro A, Tokos K, 2009.** Atmospheric lifetime of fossil fuel carbon dioxide. *Annual Review of Earth and Planetary Sciences* 37, 117–134.
- Askarieh M M, Chambers A V, Daniel F B D, FitzGerald P L, Holtom G J, Pilkington N J, Rees J H, 2000.** The chemical and microbial degradation of cellulose in the near field of a repository for radioactive wastes. *Waste Management* 20, 93–106.
- Auqué L F, Gimeno M, Acero P, Gómez J B, 2013.** Composition of groundwater for SFR and its extension, during different climatic cases, SR-PSU. SKB R-13-16, Svensk Kärnbränslehantering AB.
- Avila R, Ekström P-A, Åstrand P-G, 2010.** Landscape dose conversion factors used in the safety assessment SR-Site. SKB TR-10-06, Svensk Kärnbränslehantering AB.
- Avila R, Kautsky U, Ekström P-A, Åstrand P-G, Saetre P, 2013.** Model of the long-term transport and accumulation of radionuclides in future landscapes. *Ambio* 42, 497–505.
- Ayres J A, 1971.** Equipment decontamination with special attention to solid waste treatment, survey report. BNWL-B-90, Battelle Northwest Laboratories, Richland, WA.
- Bear J, 1988.** Dynamics of fluids in porous media. Mineola: NY: Dover.
- Beresford N A, Brown J, Copplestone D, Garnier-Laplace J, Howard B, Larsson C-M, Oughton O, Pröhl G, Zinger I, 2007.** D-ERICA: An integrated approach to the assessment and management of environmental risks from ionising radiation. Description of purpose, methodology and application. A deliverable of the ERICA project (FI6RCT-2004-508847). Available at: <https://wiki.ceb.ac.uk/download/attachments/115017395/D-Erica.pdf?version=1&modificationDate=1263814127000&api=v2>
- Beresford N A, Barnett C L, Howard B J, Scott W A, Brown J E, Copplestone D, 2008.** Derivation of transfer parameters for use within the ERICA Tool and the default concentration ratios for terrestrial biota. *Journal of Environmental Radioactivity* 99, 1393–1407.
- Berger A, Loutre M F, 2002.** An exceptionally long interglacial ahead? *Science* 297, 1287–1288.
- Birgersson M, Andersson, 2014.** Freezing of bentonite components in SFR – modeling and laboratory testing. SKB R-14-29, Svensk Kärnbränslehantering AB.
- Birgersson M, Karnland, O. 2014.** Flow and pressure response in compacted bentonite due to external fluid pressure (in preparation). SKB TR-14-28, Svensk Kärnbränslehantering AB.
- Birgersson M, Börgesson L, Hedström M, Karnland O, Nilsson U, 2009.** Bentonite erosion. Final report. SKB TR-09-34, Svensk Kärnbränslehantering AB.
- Birgersson M, Karnland O, Nilsson U, 2010.** Freezing of bentonite. Experimental studies and theoretical considerations. SKB TR-10-40, Svensk Kärnbränslehantering AB.
- Birgersson M, Hedström M, Karnland O, 2011.** Sol formation ability of Ca/Na-montmorillonite at low ionic strength. *Physics and Chemistry of the Earth, Parts A/B/C* 36, pp 1572–1579.
- Bosson E, Sassner M, Sabel U, Gustafsson L-G, 2010.** Modelling of present and future hydrology and solute transport at Forsmark. SR-Site Biosphere. SKB R-10-02, Svensk Kärnbränslehantering AB.
- Bosson E, Selroos J-O, Stigsson M, Gustafsson L-G, Destouni G, 2013.** Exchange and pathways of deep and shallow groundwater in different climate and permafrost conditions using the Forsmark site, Sweden, as an example catchment. *Hydrogeology Journal* 21, 225–237.
- Bourbon X, Toulhoat P, 1996.** Influence of organic degradation products on the solubilisation of radionuclides in intermediate and low level radioactive wastes. *Radiochimica Acta* 74, 315–320.
- Bradbury M H, Van Loon L R 1997.** Cementitious near-field data bases for performance assessment of a L/ILW repository in a Palfris Marl Host Rock. PSI Bericht 98-01, Paul Scherrer Institute, Switzerland.



- Brandefelt J, Näslund J-O, Zhang Q, Hartikainen J, 2013.** The potential for cold climate conditions and permafrost in Forsmark in the next 60,000 years. SKB TR-13-04, Svensk Kärnbränslehantering AB.
- Brazelton W J, Morrill P L, Szponar N, Schrenk M O, 2013.** Bacterial communities associated with subsurface geochemical processes in continental serpentinite springs. *Applied Environmental Microbiology* 79, 3906–3916.
- Brodersen K E, 1999.** Hygroscopic materials in bituminized waste: experiments and modeling. In *Proceeding of the International Workshop on the Safety and Performance Evaluation of Bitumenization Processes for Radioactive Waste*, Prague, 29 June – 2 July 1999. Řež, Czech Republic, Nuclear Research Institute, 149–152.
- Brown E T (ed), 1981.** Rock characterization testing & monitoring: ISRM suggested methods. Oxford: Pergamon.
- Brown J E, Alfonso B, Avila R, Beresford N A, Copplestone D, Pröhl G, Ulanovsky A, 2008.** The ERICA Tool. *Journal of Environmental Radioactivity* 99, 1371–1383.
- Brunberg A-K, Nilsson E, Blomqvist P, 2002.** Characteristics of oligotrophic hardwater lakes in a postglacial land-rise area in mid-Sweden. *Freshwater Biology* 47, 1451–1462.
- Brunberg A-K, Carlsson T, Blomqvist P, Brydsten L, Strömgren M, 2004.** Forsmark site investigation. Identification of catchments, lake-related drainage parameters and lake habitats. SKB P-04-25, Svensk Kärnbränslehantering AB.
- Bruno J, Alexander R, Van Loon L, Thorne M, 2013.** The potential radionuclide migration role of bitumen colloids at SFR. SKB P-13-41, Svensk Kärnbränslehantering AB.
- Brydsten L, 2004.** A mathematical model for lake ontogeny in terms of filling with sediments and macrophyte vegetation. SKB TR-04-09, Svensk Kärnbränslehantering AB.
- Brydsten L, 2009.** Sediment dynamics in the coastal areas of Forsmark and Laxemar during an interglacial. SKB TR-09-07, Svensk Kärnbränslehantering AB.
- Brydsten L, Strömgren M, 2010.** A coupled regolith-lake development model applied to the Forsmark site. SKB TR-10-56, Svensk Kärnbränslehantering AB.
- Brydsten L, Strömgren M, 2013.** Landscape development in the Forsmark area from the past into the future (8500 BC – 40,000 AD). SKB R-13-27, Svensk Kärnbränslehantering AB.
- Börgesson L, Åkesson M, Kristensson O, Malmberg D, Birgersson M, Hernelind J, 2014.** Modelling of critical H-M processes in the engineered barriers of SFR. SKB TR-14-27, Svensk Kärnbränslehantering AB.
- Chambers A V, Gould L J, Jackson C P, Pilkington N J, Tearle W M, Tweed C-J, 2002.** The development of methodologies for characterising the uncertainties in time-dependent chemical parameters: impact of organic complexants. Report AEAT/ERRA-0377, AEA Technology.
- Collins G S, Melosh H J, Marcus R A, 2005.** Earth Impact Effects Program: a web-based computer program for calculating the regional environmental consequences of a meteoroid impact on Earth. *Meteoritics & Planetary Science* 40, 817–840.
- Crawford J, 2013.** Quantification of rock matrix  $K_d$  data and uncertainties for SR-PSU. SKB R-13-38, Svensk Kärnbränslehantering AB.
- Cronstrand P, 2007.** Modelling the long-time stability of the engineered barriers of SFR with respect to climate changes. SKB R-07-51, Svensk Kärnbränslehantering AB.
- Cronstrand P, 2014.** Evolution of pH in SFR 1. SKB R-14-01, Svensk Kärnbränslehantering AB.
- Curtis P, Markström I, Petersson J, Triumf C-A, Isaksson H, Mattsson H, 2011.** Site investigation SFR. Bedrock geology. SKB R-10-49, Svensk Kärnbränslehantering AB.
- Dario M, Molera M, Allard B, 2004.** Effect of organic ligands on the sorption of europium on  $TiO_2$  and cement at high pH. SKB TR-04-04, Svensk Kärnbränslehantering AB.

- Driesschaert E, Fichet T, Goosse H, Huybrechts P, Janssens I, Mouchet A, Munhoven G, Brovkin V, Weber S L, 2007.** Modeling the influence of Greenland ice sheet melting on the Atlantic meridional overturning circulation during the next millennia. *Geophysical Research Letters* 34, L10707. doi:10.1029/2007GL029516
- Duro L, Grivé M, Domènech C, Román-Ross G, Bruno J, 2012.** Assessment of the evolution of the redox conditions in SFR 1. SKB TR-12-12, Svensk Kärnbränslehantering AB.
- EC, 2005.** ECOCLAY II. Effects of cement on clay barrier performance – Phase II. Final report. EUR 21921, European Commission.
- Ek B-M, Thunholm B, Östergren I, Falk R, Mjönes L, 2007.** Naturlig radioaktivitet, uran och andra metaller i dricksvatten. SGU rapport 2007:13, Geological Survey of Sweden. (In Swedish.)
- Engkvist I, Albinsson Y, Johansson Engkvist W, 1996.** The long-term stability of cement – Leaching tests. SKB TR 96-09, Svensk Kärnbränslehantering AB.
- Erichsen A C, Konovalenko L, Møhlenberg F, Closter R M, Bradshaw C, Aquilonius K, Kautsky U, 2013.** Radionuclide transport and uptake in coastal aquatic ecosystems: a comparison of a 3D dynamic model and a compartment model. *Ambio* 42, 464–475.
- Fernández R, Cuevas J, Mäder U K, 2009.** Modelling concrete interaction with a bentonite barrier. *European Journal of Mineralogy* 21, 177–191.
- Ferry J G, 1993.** Fermentation of acetate. In Ferry J G (ed). *Methanogenesis: ecology, physiology, biochemistry and genetics*. New York: Chapman & Hall, 304–334.
- French H M, 2007.** *The periglacial environment*. 3rd ed. Chichester: Wiley.
- Gangopadhyay A, Talwani P, 2003.** Symptomatic features of intraplate earthquakes. *Seismological Research Letters* 74, 863–883.
- Gaucher E, Tournassat C, Nowak C, 2005.** Modelling the geochemical evolution of the multi-barrier system of the Silo of the SFR repository. Final report. SKB R-05-80, Svensk Kärnbränslehantering AB.
- Gent P R, Danabasoglu G, Donner L J, Holland M M, Hunke E C, Jayne S R, Lawrence D M, Neale R B, Rasch P J, Vertenstein M, Worley P H, Yang Z-L, Zhang M, 2011.** The Community Climate System Model Version 4. *Journal of Climate* 24, 4973–4991.
- Gentzschlein B, Levén J, Follin S, 2007.** A comparison between well yield data from the site investigation in Forsmark and domestic wells in northern Uppland. SKB P-06-53, Svensk Kärnbränslehantering AB.
- Georgiev G, 2013.** A seismic evaluation of SFR. Analysis of the Silo structure for earthquake load. SKB R-13-52, Svensk Kärnbränslehantering AB.
- Gimeno M J, Auqué L F, Gómez J B, Acero P, 2011.** Site investigation SFR. Water–rock interaction and mixing modeling in the SFR. SKB P-11-25, Svensk Kärnbränslehantering AB.
- Glaus M A, Van Loon L R, 2004.** A generic procedure for the assessment of the effect of concrete admixtures on the retention behaviour of cement for radionuclides: Concept and case studies. PSI Bericht 04-02, Paul Scherrer Institute, Switzerland.
- Glaus M A, Van Loon L R, 2008.** Degradation of cellulose under alkaline conditions: new insights from a 12 year degradation study. *Environmental Science & Technology* 42, 2906–2911.
- Glaus M A, Van Loon L R, Achatz S, Chodura A, Fischer K, 1999.** Degradation of cellulosic materials under the alkaline conditions of a cementitious repository for low and intermediate level radioactive waste. Part I: Identification of degradation products. *Analytica Chimica Acta* 398, 111–122.
- Gorbunova O A, Barinov A S, 2012.** Microbiological evaluation of the condition of cement compounds with radioactive wastes after long-term storage in near-surface repositories. *Radiochemistry* 54, 198–204.
- Grbić-Galić S, Churchman-Eisel N, Mraković I, 1990.** Microbial transformation of styrene by anaerobic consortia. *Journal of Applied Bacteriology* 69, 247–260.
- Greenfield B F, Harrison W N, Robertson G P, Somers P J, Spindler M W, 1993.** Mechanistic studies of the alkaline degradation of cellulose in cement. Nirex Report NSS/R272, Nirex Ltd., UK.

- Greenfield B F, Hurdus M H, Pilkington N J, Spindler M W, Williams S J, 1994.** The degradation of cellulose in the near field of a radioactive waste repository. In Barkatt A, Van Konynenburg R A (eds). Scientific basis for nuclear waste management XVII: symposium held in Boston, Massachusetts, USA, 29 November – 3 December. Pittsburgh, PA: Materials Research Society. (Materials Research Society Symposium Proceedings 333), 705–710.
- Grolander S, 2013.** Biosphere parameters used in radionuclide transport modelling and dose calculations in SR-PSU. SKB R-13-18, Svensk Kärnbränslehantering AB.
- Gustafsson B G, 2004.** Millennial changes of the Baltic Sea salinity. Studies of the sensitivity of the salinity to climate change. SKB TR-04-12, Svensk Kärnbränslehantering AB.
- Hamrén U, Collinder P, 2010.** Vattenverksamhet i Forsmark. Ekologisk fältinventering och naturvärdesklassificering samt beskrivning av skogsproduktionsmark. SKB R-10-16, Svensk Kärnbränslehantering AB. (In Swedish, with summary in English.)
- Hartikainen J, Kouhia R, Wallroth T, 2010.** Permafrost simulations at Forsmark using a numerical 2D thermo-hydro-chemical model. SKB TR-09-17, Svensk Kärnbränslehantering AB.
- Hedenström A, Sohlenius G, 2008.** Description of the regolith at Forsmark. Site descriptive modelling, SDM-Site Forsmark. SKB R-08-04, Svensk Kärnbränslehantering AB.
- Hedenström A, Sohlenius G, Strömberg M, Brydsten L, Nyman H, 2008.** Depth and stratigraphy of regolith at Forsmark. Site descriptive modelling, SDM-Site Forsmark. SKB R-08-07, Svensk Kärnbränslehantering AB.
- Helmens K F, 2013.** The last interglacial-glacial cycle (MIS5-2) re-examined based on long proxy records from central and northern Europe. SKB TR-13-02, Svensk Kärnbränslehantering AB.
- Holmén J G, 2005.** SFR-1. Inverse modelling of inflow to tunnels and propagation of estimated uncertainties to predictive stages. SKB R-05-74, Svensk Kärnbränslehantering AB.
- Holmén J G, Stigsson M, 2001.** Modelling of future hydrogeological conditions at SFR. SKB R-01-02, Svensk Kärnbränslehantering AB.
- Hummel W, Anderegg G, Rao L, Puigdomenech I, Tochiyama O, 2005.** Chemical thermodynamics. vol 9. Chemical thermodynamics of compounds and complexes of U, Np, Pu, Am, Tc, Se, Ni and Zr with selected organic ligands. Paris:OECD/NEA.
- Höglund L O, 2001.** Project SAFE. Modelling of long-term concrete degradation processes in the Swedish SFR repository. SKB R-01-08, Svensk Kärnbränslehantering AB.
- Höglund L O, 2014.** The impact of concrete degradation on the BMA barrier functions. SKB R-13-40, Svensk Kärnbränslehantering AB.
- IAEA, 2007.** IAEA safety glossary: terminology used in nuclear safety and radiation protection. 2007 Edition. Vienna: International Atomic Energy Agency.
- IAEA, 2009.** Classification of radioactive waste. Vienna: International Atomic Energy Agency. (General Safety Guide GSG-1)
- IAEA, 2011.** Disposal of radioactive waste. Vienna: International Atomic Energy Agency. (IAEA Safety Standards Series SSR 5)
- ICRP, 2000.** Radiation protection recommendations as applied to the disposal of long-lived solid radioactive waste. Oxford: Pergamon. (ICRP Publication 81; Annals of the ICRP 28)
- ICRP, 2003.** A framework for assessing the impact of ionising radiation on non-human species. Oxford: Pergamon. (ICRP Publication 91; Annals of the ICRP 33)
- ICRP, 2006.** Assessing dose of the representative person for the purpose of radiation protection of the public and the optimisation of radiological protection: broadening the process. Oxford: Pergamon. (ICRP Publication 101; Annals of the ICRP 36)
- ICRP, 2008.** Environmental protection: the concept and use of reference animals and plants. Oxford: Elsevier. (ICRP Publication 108; Annals of the ICRP 38).
- ICRP, 2013.** Radiological protection in geological disposal of long-lived solid radioactive waste. Oxford: Elsevier. (ICRP Publication 122; Annals of ICRP 42(3))

- ICRP, 2014.** Protection of the environment under different exposure situations. Oxford: Elsevier. (ICRP Publication 124; Annals of the ICRP 43(1))
- IPCC, 2007.** Climate Change 2007: the physical science basis. Cambridge: Cambridge University Press.
- IPCC, 2013.** Climate change 2013: the physical science basis: summary for policymakers. Contribution of Working Group I to the Fifth Assessment Report of the Intergovernmental Panel on Climate Change. Available at: <http://www.ipcc.ch>.
- Jaeschke B, Smith K, Nordén S, Alfonso B, 2013.** Assessment of risk to non-human biota from a repository for the disposal of spent nuclear fuel at Forsmark. Supplementary information. SKB TR-13-23, Svensk Kärnbränslehantering AB.
- Johansson P-O, 2008.** Description of surface hydrology and near-surface hydrogeology at Forsmark. Site descriptive modelling, SDM-Site Forsmark. SKB R-08-08, Svensk Kärnbränslehantering AB.
- Johansson P-O, Werner K, Bosson E, Berglund S, Juston J, 2005.** Description of climate, surface hydrology, and near-surface hydrogeology. Preliminary site description Forsmark area – version 1.2. SKB R-05-06, Svensk Kärnbränslehantering AB.
- Karlsson A, Eriksson C, Borell Lövestedt C, Liungman O, Engqvist A, 2010.** High-resolution hydrodynamic modelling of the marine environment at Forsmark between 6500 BC and 9000 AD. SKB R-10-09, Svensk Kärnbränslehantering AB.
- Kautsky U (ed), 2001.** The biosphere today and tomorrow in the SFR area. SKB R-01-27, Svensk Kärnbränslehantering AB.
- Keith-Roach M J, 2008.** The speciation, stability, solubility and biodegradation of organic co-contaminant radionuclide complexes: a review. *Science of the Total Environment* 396, 1–11.
- Keith-Roach M, Lindgren M, Källström K, 2014.** Assessment of complexing agent concentrations in SFR. SKB R-14-03, Svensk Kärnbränslehantering AB.
- Kellner E, 2003.** Wetlands – different types, their properties and functions. SKB TR-04-08, Svensk Kärnbränslehantering AB.
- Kienzler B, Vejmelka P, Römer J, Schild D, Jansson M, 2009.** Actinide migration in fractures of granite host rock: laboratory and in situ investigations. *Nuclear Technology* 165, 223–240.
- Kjellström E, Strandberg G, Brandefelt J, Näslund J-O, Smith B, Wohlfarth B, 2009.** Climate conditions in Sweden in a 100,000-year time perspective. SKB TR-09-04, Svensk Kärnbränslehantering AB.
- Koskinen A, Hakanen M, Lindberg A, 1988.** Sorption experiments at oxic and anoxic conditions. Report YJT-88-05, Nuclear Waste Commission of Finnish Power Companies, Finland.
- Laaksoharju M, Smellie J, Tullborg E-L, Gimeno M, Hallbäck L, Molinero J, Waber N, 2008.** Bedrock hydrogeochemistry Forsmark. Site descriptive modelling, SDM-Site Forsmark. SKB R-08-47, Svensk Kärnbränslehantering AB.
- Lagerblad B, Trägårdh J, 1994.** Conceptual model for concrete long time degradation in a deep nuclear waste repository. SKB TR 95-21, Svensk Kärnbränslehantering AB.
- Lidberg M, Johansson J M, Scherneck H-G, Milne G A, 2010.** Recent results based on continuous GPS observations of the GIA process in Fennoscandia from BIFROST. *Journal of Geodynamics* 50, 8–18.
- Lindborg T (ed), 2010.** Landscape Forsmark – data, methodology and results for SR-Site. SKB TR-10-05, Svensk Kärnbränslehantering AB.
- Lindgren M, Pettersson M, Karlsson S, Moreno L, 2001.** Project SAFE. Radionuclide release and dose from the SFR repository. SKB R-01-18, Svensk Kärnbränslehantering AB.
- Lindroos H, Isaksson H, Thunehed H, 2004.** The potential for ore and industrial minerals in the Forsmark area. SKB R-04-18, Svensk Kärnbränslehantering AB.
- Lundgren K, 2006.** Mo-93, Tc-99 och Cs-135: uppskattning av aktivitet i driftavfall från svenska LWR, Clab och Studsvik. Rapport 06-0031R, rev 1, Alara Engineering.

- Lundin L, Lode E, Stendahl J, Melkerud P-A, Björkvald L, Thorstensson A, 2004.** Soils and site types in the Forsmark area. SKB R-04-08, Svensk Kärnbränslehantering AB.
- Löfgren A (ed), 2010.** The terrestrial ecosystems at Forsmark and Laxemar-Simpevarp. SR-Site Biosphere. SKB TR-10-01, Svensk Kärnbränslehantering AB.
- Löfgren A, 2011.** Dissolved inorganic carbon and organic carbon in mires in the Forsmark area. A pilot study. SKB P-11-23, Svensk Kärnbränslehantering AB.
- Machell G, Richards G N, 1960.** Mechanism of saccharinic acid formation. Part I. Competing in the alkaline degradation of 4-O-methyl-D-glucose, maltose, amylose and cellulose. *Journal of the Chemical Society* 1960, 1924–1931.
- Mas Ivars D, Ríos M V, Shiu W, Johansson F, Fredriksson A, 2014.** Long term stability of rock caverns BMA and BLA of SFR, Forsmark. SKB R-13-53, Svensk Kärnbränslehantering AB.
- Means J L, Alexander C A, 1981.** The environmental biogeochemistry of chelating agents and recommendations for the disposal of chelated radioactive wastes. *Nuclear and Chemical Waste Management* 2, 183–196.
- Miliander S, Punakivi M, Kyläkorpi L, Rydgren B, 2004.** Human population and activities in Forsmark. Site description. SKB R-04-10, Svensk Kärnbränslehantering AB.
- Moreno L, Neretnieks I, 2013.** Impact of gas generation on radionuclide release – comparison between results for new and old data. SKB P-13-40, Svensk Kärnbränslehantering AB.
- Moreno L, Skagius K, Södergren S, Wiborgh M, 2001.** Project SAFE. Gas related processes in SFR. SKB R-01-11, Svensk Kärnbränslehantering AB.
- NEA, 1999.** Safety assessment of radioactive waste repositories – An international database of features, events and processes. A report on of the NEA working group on development of a Database of Features, Events and Processes Relevant to the Assessment of Post-closure Safety of Radioactive Waste Repositories. Nuclear Agency of the Organisation for Economic Cooperation and Development (OECD/NEA), Paris. Electronic version 1.2 of the NEA FEP Database developed on behalf of the Nuclear Energy Agency by Safety Assessment Management Ltd. with support of Quintessa Ltd.
- NEA, 2006.** Electronic version 2.1 of the NEA FEP database developed on behalf of the Nuclear Energy Agency by Safety Assessment Management Ltd.
- NEA, 2011.** Preservation of records, knowledge and memory across generations. An international project of the NEA/RWMC. Paris: OECD/NEA.
- Neretnieks I, Moreno L, 2013.** Flow and transport in fractures in concrete walls in BMA – Problem formulation and scoping calculations. SKB R-13-51, Svensk Kärnbränslehantering AB.
- Neretnieks I, Moreno L, 2014.** Discussion on  $^{14}\text{CH}_4$  gas formation and release from SFR 1 repository. SKB R-14-32, Svensk Kärnbränslehantering AB.
- Nilsson A-C, Tullborg E-L, Smellie J, Gimeno M J, Gómez J B, Auqué L F, Sandström B, Pedersen K, 2011.** SFR site investigation. Bedrock hydrogeochemistry. SKB R-11-06, Svensk Kärnbränslehantering AB.
- Norman S, Kjellbert N, 1990.** FARF31 – A far field radionuclide migration code for use with the PROPER package. SKB TR 90-01, Svensk Kärnbränslehantering AB.
- Näslund J-O, Brandefelt J, Claesson Liljedahl L, 2013.** Climate considerations in long-term safety assessments for nuclear waste repositories. *Ambio* 42, 393–401.
- Odén M, Follin S, Öhman J, Vidstrand P, 2014.** SR-PSU Bedrock hydrogeology. Groundwater flow modelling methodology, setup and results. SKB R-13-25, Svensk Kärnbränslehantering AB.
- Omori T, Jigami Y, Minoda Y, 1974.** Microbial oxidation of alpha-methylstyrene and beta-methylstyrene. *Agricultural and Biological Chemistry* 38, 409–415.
- Omori T, Jigami Y, Minoda Y, 1975.** Isolation, identification, and substrate assimilation specificity of some aromatic hydrocarbon utilizing bacteria. *Agricultural and Biological Chemistry* 39, 1775–1779.
- Pavasars I, 1999.** Characterisation of organic substances in waste materials under alkaline conditions. PhD thesis. Linköping University, Sweden.

- Pedersen K, 2001.** Project SAFE. Microbial features, events and processes in the Swedish final repository for low- and intermediate-level radioactive waste. SKB R-01-05, Svensk Kärnbränslehantering AB.
- Pedersen K, Nilsson E, Arlinger J, Hallbeck L, O'Neill A, 2004.** Distribution, diversity and activity of microorganisms in the hyper-alkaline spring waters of Maqarin in Jordan. *Extremophiles* 8, 151–164.
- Pers K, Skagius K, Södergren S, Wiborgh M, Hedin A, Morén L, Sellin P, Ström A, Pusch R, Bruno J, 1999.** SR 97 – Identification and structuring of process. SKB TR-99-20, Svensk Kärnbränslehantering AB.
- Pettersson M, Elert M, 2001.** Characterisation of bituminised waste in SFR 1. SKB R-01-26, Svensk Kärnbränslehantering AB.
- Qvarfordt S, Borgiel M, Berg C, 2010.** Monitoring Forsmark. Hydrochemical investigations in four calciferous lakes in the Forsmark area. Results from complementary investigations in the Forsmark area, 2008–2009. SKB P-10-25, Svensk Kärnbränslehantering AB.
- Román-Ross G, Trincherro P, Maia F, Molinero J, 2014.** Hydrogeochemical modelling and proposed evolution of the groundwater types and processes in the geosphere of SFR, SR-PSU. SKB R-13-30, Svensk Kärnbränslehantering AB.
- Rout S P, Radford J, Laws A P, Sweeney F, Elmekawy A, Gillie L J, Humphreys P N, 2014.** Biodegradation of the alkaline cellulose degradation products generated during radioactive waste disposal. *PLoS One* 9. doi:e107433. doi:10.1371/journal.pone.0107433.
- Saetre P, Nordén S, Keesmann S, Ekström P-A, 2013.** The biosphere model for radionuclide transport and dose assessment in SR-PSU. SKB R-13-46, Svensk Kärnbränslehantering AB.
- Sandström B, Tullborg E-L, 2011.** Site investigation SFR. Fracture mineralogy and geochemistry of borehole sections sampled for groundwater chemistry and Eh. Results from boreholes KFR01, KFR08, KFR10, KFR19, KFR7A and KFR105. SKB P-11-01, Svensk Kärnbränslehantering AB.
- Sandström B, Tullborg E-L, Sidborn M, 2013.** Iron hydroxide occurrences and redox capacity in bedrock fractures in the vicinity of SFR. SKB R-12-11, Svensk Kärnbränslehantering AB.
- Savage D, 2011.** A review of analogues of alkaline alteration with regard to long-term barrier performance. *Mineralogical Magazine* 75, 2401–2418.
- Savage D, Stenhouse M, Benbow M, 2000.** Evolution of near-field physico-chemical characteristics of the SFR repository. SKI Report 00:49, Statens kärnkraftinspektion (Swedish Nuclear Power Inspectorate).
- Sercombe J, Gwinner B, Tiffreau C, Simondi-Teisseire B, Adenot F, 2006.** Modelling of bituminized radioactive waste leaching. Part I: Constitutive equations. *Journal of Nuclear Materials* 349, 96–106.
- SFS 1984:3.** Lag om kärnteknisk verksamhet (Nuclear Activities Act). Stockholm: Ministry of the Environment. (In Swedish.)
- SFS 1998:808.** Miljöbalk (Environmental Code). Stockholm: Ministry of the Environment. (In Swedish.)
- SFS 1988:220.** Strålskyddslag (Radiation Protection Act). Stockholm: Ministry of the Environment. (In Swedish.)
- SGU, 2011.** Brunnsarkivet [Archive of wells]. Available at: <http://www.sgu.se/produkter/geologiska-data/ta-del-av-vara-data/Om-SGUs-data/sgus-grundvattendata/data-fran-brunnsarkivet/> [June 2011].
- Sheppard S, Long J, Sanipelli B, Sohlenius G, 2009.** Solid/liquid partition coefficients ( $K_d$ ) for selected soils and sediments at Forsmark and Laxemar-Simpevarp. SKB R-09-27, Svensk Kärnbränslehantering AB.
- Sheppard S, Sohlenius G, Omberg L-G, Borgiel M, Grolander S, Nordén S, 2011.** Solid/liquid partition coefficients ( $K_d$ ) and plant/soil concentration ratios (CR) for selected soils, tills and sediments at Forsmark. SKB R-11-24, Svensk Kärnbränslehantering AB.
- Shirai K, Hisatsuka K, 1979.** Production of beta-phenethyl alcohol from styrene by *Pseudomonas* 305-STR-1-4. *Agricultural and Biological Chemistry* 43, 1399–1406.

- Sielicki M, Focht D D, Martin J P, 1978.** Microbial transformations of styrene and [<sup>14</sup>C] styrene in soil and enrichment cultures. *Applied and Environmental Microbiology* 35, 124–128.
- SKB, 1999.** SR 97. Processes in the repository evolution. SKB TR-99-07, Svensk Kärnbränslehantering AB.
- SKB, 2001a.** Project SAFE. Scenario and system analysis. SKB R-01-13, Svensk Kärnbränslehantering AB.
- SKB, 2001b.** Project SAFE Compilation of data for radionuclide transport analysis. SKB R-01-14, Svensk Kärnbränslehantering AB.
- SKB, 2006a.** FEP report for the safety assessment SR-Can. SKB TR-06-20, Svensk Kärnbränslehantering AB.
- SKB, 2006b.** Long-term safety for KBS-3 repositories at Forsmark and Laxemar – a first evaluation. Main report of the SR-Can project. SKB TR-06-09, Svensk Kärnbränslehantering AB.
- SKB, 2007.** Forsmark site investigation. Programme for long-term observations of geosphere and biosphere after completed site investigations. SKB R-07-34, Svensk Kärnbränslehantering AB.
- SKB, 2008a.** SFR 1. Slutlig säkerhetsrapport, pärm 2. Svensk Kärnbränslehantering AB. (English translation: Safety analysis SFR 1. Long-term safety. SKB R-08-130, Svensk Kärnbränslehantering AB).
- SKB, 2008b.** Site description of Forsmark at completion of the site investigation phase. SDM-Site Forsmark. SKB TR-08-05, Svensk Kärnbränslehantering AB.
- SKB, 2008c.** Project SFR 1 SAR-08. Update of priority of FEPs from Project SAFE. SKB R-08-12, Svensk Kärnbränslehantering AB.
- SKB, 2010a.** FEP report for the safety assessment SR-Site. SKB TR-10-45, Svensk Kärnbränslehantering AB.
- SKB, 2010b.** Geosphere process report for the safety assessment SR-Site. SKB TR-10-48, Svensk Kärnbränslehantering AB.
- SKB, 2010c.** Climate and climate-related issues for the safety assessment SR-Site. SKB TR-10-49, Svensk Kärnbränslehantering AB.
- SKB, 2010d.** Handling of future human actions in the safety assessment SR-Site. SKB TR-10-53, Svensk Kärnbränslehantering AB.
- SKB, 2010e.** Biosphere analyses for the safety assessment SR-Site – synthesis and summary of results. SKB TR-10-09, Svensk Kärnbränslehantering AB.
- SKB, 2010f.** Radionuclide transport report for the safety assessment SR-Site. SKB TR-10-50, Svensk Kärnbränslehantering AB.
- SKB, 2011.** Long-term safety for the final repository for spent nuclear fuel at Forsmark. Main report of the SR-Site project. SKB TR-11-01, Svensk Kärnbränslehantering AB.
- SKB, 2013a.** Låg- och medelaktivt avfall i SFR. Referensinventarium för avfall 2013. SKB R-13-37, Svensk Kärnbränslehantering AB. (In Swedish.) An English translation of the report is published as SKB, 2015. Low and intermediate level waste in SFR. Reference inventory for waste 2013. SKB R-15-15, Svensk Kärnbränslehantering AB.
- SKB, 2013b.** Plats för slutförvaring av kortlivat rivningsavfall. SKB P-13-01, Svensk Kärnbränslehantering AB. (In Swedish.)
- SKB, 2013c.** Components, features, processes and interactions in the biosphere. SKB R-13-43, Svensk Kärnbränslehantering AB.
- SKB, 2013d.** RD&D Programme 2013. Programme for research, development and demonstration of methods for the management and disposal of nuclear waste. SKB TR-13-18, Svensk Kärnbränslehantering AB.
- SKB, 2013e.** Site description of the SFR area at Forsmark at completion of the site investigation phase. SDM-PSU Forsmark. SKB TR-11-04, Svensk Kärnbränslehantering AB.
- SKB, 2014a.** Miljökonsekvensbeskrivning. Utbyggnad och fortsatt drift av SFR. Svensk Kärnbränslehantering AB. (In Swedish.)

- SKB, 2015.** Handling of biosphere FEPs and recommendations for model development in SR-PSU. SKB R-14-02, Svensk Kärnbränslehantering AB.
- SKI, 1992a.** Project Seismic Safety. Characterization of seismic ground motions for probabilistic safety analyses of nuclear facilities in Sweden. Summary report. SKI Technical Report 92:3, Statens kärnkraftinspektion (Swedish Nuclear Power Inspectorate).
- SKI, 1992b.** Kompletterande driftmedgivande för SFR-1, 1992-05-20, SKI dnr 7.41 433/88, Statens kärnkraftinspektion (Swedish Nuclear Power Inspectorate). (In Swedish.)
- Smellie J A T (ed), 1998.** Maqarin Natural Analogue Study: Phase III. SKB TR 98-04, Svensk Kärnbränslehantering AB.
- Small J, Nykyri M, Helin M, Hovi U, Sarlin T, Itävaara M, 2008.** Experimental and modelling investigations of the biogeochemistry of gas production from low and intermediate level radioactive waste. *Applied Geochemistry* 23, 1383–1418.
- Sohlenius G, Strömgren M, Hartz F, 2013a.** Depth and stratigraphy of regolith at Forsmark. SR-PSU Biosphere. SKB R-13-22, Svensk Kärnbränslehantering AB.
- Sohlenius G, Saetre P, Nordén S, Grolander S, Sheppard S, 2013b.** Inferences about radionuclide mobility in soils based on the solid/liquid partition coefficients and soil properties. *Ambio* 42, 414–424.
- Solomon S, Battisti D, Doney S, Hayhoe K, Held I M, Lettenmaier D P, Lobell D, Matthews H D, Pierrehubert R, Raphael M, Richels R, Root R L, Steffen K, Tebalidi C, Yohe G W, 2011.** *Climate stabilization targets: emissions, concentrations, and impacts over decades to millennia.* Washington, DC: National Academies Press.
- Sonesten L, 2005.** Chemical characteristics of surface waters in the Forsmark area. Evaluation of data from lakes, streams, and coastal sites. SKB R-05-41, Svensk Kärnbränslehantering AB.
- SSI, 2003.** Uppdaterade driftsvillkor för SFR 1, Dnr 6222/3744/03, 2003-12-08. Statens strålskydds-institut (Swedish Radiation Protection Authority). (In Swedish.)
- SSM, 2009.** Granskning av SFR-1 SAR-08. SSM dnr 2008/961, Strålsäkerhetsmyndigheten (Swedish Radiation Safety Authority). (In Swedish.)
- SSM, 2010.** Beslut rörande driften av SFR-1. SSM dnr: 2008/981, Strålsäkerhetsmyndigheten (Swedish Radiation Protection Authority). (In Swedish.)
- SSMFS 2008:1.** The Swedish Radiation Safety Authority's regulations concerning safety in nuclear facilities. Stockholm: Strålsäkerhetsmyndigheten (Swedish Radiation Safety Authority).
- SSMFS 2008:21.** The Swedish Radiation Safety Authority's regulations concerning safety in connection with the disposal of nuclear material and nuclear waste. Stockholm: Strålsäkerhets-myndigheten (Swedish Radiation Safety Authority).
- SSMFS 2008:37.** The Swedish Radiation Safety Authority's regulations concerning the protection of human health and the environment in connection with the final management of spent nuclear fuel and nuclear waste. Stockholm: Strålsäkerhetsmyndigheten (Swedish Radiation Safety Authority).
- SSMFS 2011:2.** The Swedish Radiation Safety Authority's regulations and general advice concerning clearance of materials, rooms, buildings and land in practices involving ionising radiation. Stockholm: Strålsäkerhetsmyndigheten (Swedish Radiation Safety Authority).
- Strömgren M, Brydsten L, 2008.** Digital elevation models of Forsmark. Site descriptive modelling, SDM-Site Forsmark. SKB R-08-62, Svensk Kärnbränslehantering AB.
- Strömgren M, Brydsten L, 2013.** Digital elevation model of Forsmark. Site-descriptive modelling. SR-PSU biosphere. SKB R-12-03, Svensk Kärnbränslehantering AB.
- Stumm W, Morgan J J, 1996.** *Aquatic chemistry: chemical equilibria and rates in natural waters.* 3rd ed. New York: Wiley.
- Sundberg J, Back P-E, Ländell M, Sundberg A, 2009.** Modelling of temperature in deep boreholes and evaluation of geothermal heat flow at Forsmark and Laxemar. SKB TR-09-14, Svensk Kärnbränslehantering AB.



- Svensson U, Ferry M, Kuylenstierna H-O, 2010.** DarcyTools version 3.4. Concepts, methods and equations. SKB R-07-38, Svensk Kärnbränslehantering AB.
- Swanton S, Alexander W R, Berry J A, 2010.** Review of the behaviour of colloids in the near field of a cementitious repository. Report to NDA RWMD. Serco/TAS/000475/01, Serco, UK.
- Söderbäck B (ed), 2008.** Geological evolution, palaeoclimate and historical development of the Forsmark and Laxemar-Simpevarp areas. Site descriptive modelling. SDM-Site. SKB R-08-19, Svensk Kärnbränslehantering AB.
- Thomson G, Herben M, Lloyd P, Rose D, Smith C, Barraclough I, 2008.** Implementation of Project Safe in Amber. Verification study for SFR 1 SAR-08. SKB R-08-13, Svensk Kärnbränslehantering AB.
- Thorsell P-E, 2013.** Studier av frysningsegenskaper hos betong från 1 BMA. SKB P-13-07, Svensk Kärnbränslehantering AB. (In Swedish.)
- Tröjbom M, Grolander S, 2010.** Chemical conditions in present and future ecosystems in Forsmark – implications for selected radionuclides in the safety assessment SR-Site. SKB R-10-27, Svensk Kärnbränslehantering AB.
- Tröjbom M, Nordén S, 2010.** Chemistry data from surface ecosystems in Forsmark and Laxemar-Simpevarp. Site specific data used for estimation of CR and  $K_d$  values in SR-Site. SKB R-10-28, Svensk Kärnbränslehantering AB.
- Tröjbom M, Söderbäck B, 2006.** Chemical characteristics of surface systems in the Forsmark area. Visualisation and statistical evaluation of data from shallow groundwater, precipitation, and regolith. SKB R-06-19, Svensk Kärnbränslehantering AB.
- Tröjbom M, Söderbäck B, Johansson P-O, 2007.** Hydrochemistry in surface water and shallow groundwater. Site descriptive modelling, SDM-Site Forsmark. SKB R-07-55, Svensk Kärnbränslehantering AB.
- Tröjbom M, Grolander S, Rensfeldt V, Nordén S, 2013.**  $K_d$  and CR used for transport calculation in the biosphere in SR-PSU. SKB R-13-01, Svensk Kärnbränslehantering AB.
- UNSCEAR, 2000.** Sources and effects of ionizing radiation. Volume I: Sources. UNSCEAR 2000 report to the General Assembly, with scientific annexes. United Nations Scientific Committee on the Effects of Atomic Radiation.
- UNSCEAR, 2010.** Sources and effects of ionizing radiation. Volume I. UNSCEAR 2008 Report to the General Assembly with Scientific Annexes. United Nations Scientific Committee on the Effects of Atomic Radiation.
- Van Loon L R, Glaus M A, 1998.** Experimental and theoretical studies on alkaline degradation of cellulose and its impact on the sorption of radionuclides. PSI Bericht 98-07, Paul Scherrer Institute, Switzerland. Also published as Nagra Technical Report NTB 97-04, Nagra, Switzerland.
- Van Loon L R, Hummel W, 1999a.** Radiolytic and chemical degradation of strong acidic ion-exchange resins: study of the ligands formed. Nuclear Technology 128, 359–371.
- Van Loon L R, Hummel W, 1999b.** The degradation of strong basic anion exchange resins and mixed-bed ion exchange resins: Effect of degradation products on radionuclide speciation. Nuclear Technology 128, 388–401.
- Vidstrand P, Follin S, Zügel N, 2010.** Groundwater flow modelling of periods with periglacial and glacial climate conditions – Forsmark. SKB R-09-21, Svensk Kärnbränslehantering AB.
- Vidstrand P, Follin S, Selroos J-O, Näslund J-O, Rhén I, 2013.** Modeling of groundwater flow at depth in crystalline rock beneath a moving ice-sheet margin, exemplified by the Fennoscandian Shield, Sweden. Hydrogeology Journal 21, 239–255.
- Vidstrand P, Follin S, Selroos J-O, Näslund J-O, 2014.** Groundwater flow modeling of periods with periglacial and glacial climate conditions for the safety assessment of the proposed high-level nuclear waste repository site at Forsmark, Sweden. Hydrogeology Journal 22, 1251–1267.
- von Schenck H, Bultmark F, 2014.** Effekt av bitumensvällning i silo och BMA. SKB R-13-12, Svensk Kärnbränslehantering AB. (In Swedish.)

- Väisäsvaara J, 2009.** Site investigation SFR. Difference flow logging in borehole KFR105. SKB P-09-09, Svensk Kärnbränslehantering AB.
- Werner K, Hamrén U, Collinder P, 2010.** Vattenverksamhet i Forsmark (del I). Grundvattenbortledning från slutförvarsanläggningen för använt kärnbränsle. SKB R-10-14, Svensk Kärnbränslehantering AB. (In Swedish, with Summary in English.)
- Werner K, Sassner M, Johansson E, 2014.** Hydrology and near-surface hydrogeology at Forsmark – synthesis for the SR-PSU project. SR-PSU Biosphere. SKB R-13-19, Svensk Kärnbränslehantering AB.
- Westman P, Wastegård S, Schoning K, Gustafsson B, Omstedt A, 1999.** Salinity change in the Baltic Sea during the last 8,500 years: evidence, causes and models. SKB TR-99-38, Svensk Kärnbränslehantering AB.
- Wohlfarth B, 2013.** A review of Early Weichselian climate (MIS 5d–a) in Europe. SKB TR-13-03, Svensk Kärnbränslehantering AB.
- Yumoto I, 2007.** Alkaliphiles. In Gerday C, Glansdorff N (eds). Physiology and biochemistry of extremophiles. Washington, DC: ASM Press, 295–310.
- Öhman J, Bockgård N, Follin S, 2012.** Bedrock hydrogeology. Site investigation SFR. SKB R-11-03, Svensk Kärnbränslehantering AB.
- Öhman J, Follin S, Odén M, 2013.** Bedrock hydrogeology – Groundwater flow modelling. Site investigation SFR. SKB R-11-10, Svensk Kärnbränslehantering AB.
- Öhman J, Follin S, Odén M, 2014.** SR-PSU Hydrogeological modelling. TD11 – Temperate climate conditions. SKB P-14-04, Svensk Kärnbränslehantering AB.

#### Unpublished documents

SKBdoc id, version	Title	Issuer, year
1240154 ver 1.0	SKB Plan för förslutning av SFR 1 utifrån antaganden i SAR-08. (In Swedish.)	SKB, 2010
1358612 ver 1.0	SFR förslutningsplan. (In Swedish.)	SKB, 2014
1368638 ver 1.0	Acceptanskriterier för avfall, Projekt SFR-utbyggnad. (In Swedish.)	SKB, 2014
1386344 ver 1.0	Svar på föreläggande SAR-08. (In Swedish.)	SKB, 2014
1395200 ver 1.0	TD05 – Effects in ECPM translation	SKB, 2013
1395214 ver 2.0	TD08 – SFR 3 effect on the performance of the existing SFR 1	SKB, 2014
1395215 ver 1.0	TD10 – SFR 3 adaptation to hydrogeological conditions	SKB, 2013
1412250 ver 2.0	Ansökansinventarium för mellanlagring av långlivat avfall i SFR	SKB, 2014
1415420 ver 1.0	Utbyggnaden av SFR ur ett BAT-perspektiv. (In Swedish.)	SKB, 2014
1427105 ver 4.0	Radionuclide inventory for application of extension of the SFR repository – Treatment of uncertainties	SKB, 2015
1427919 ver 1.0	Årsrapport över deponerade polymer, aktivitetsinnehåll och material för SFR, 2013	SKB, 2014
1430701 ver 1.0	Risken för och betydelsen av ändrade redox-förhållanden. (In Swedish.)	SKB, 2014
1434623 ver 2.0	Principer för styrning av kärnavfall, deponeringsstrategi inom SFR samt tillämpning av denna inför ansökan om utbyggnad av SFR. (In Swedish.)	SKB, 2014
1462415 ver 1.0	A depth sensitivity test of the scaling laws for Darcy fluxes during SR-Sites glacial scenarios	SKB, 2014
1481419 ver 1.0	Ny beräkning av Mo-93 i normkolli till PSU 2015-05 (In Swedish.)	SKB, 2015

### Compliance with requirements from SSMFS 2008:21 in SR-PSU

#### A1 Implementation SSMFS 2008:21 in the safety assessment SR-PSU

Appendix A describes how applicable regulations have been implemented in the current assessment. References to where in the current report these are addressed have been inserted in blue at relevant places.

##### A1.1 SSMFS 2008:21

SSM has issued SSMFS 2008:21 “The Swedish Radiation Safety Authority’s regulations and general advice concerning safety in connection with the disposal of nuclear material and nuclear waste”

Whereas the Regulations have a clear legal status, general advice are described in Section 1 Ordinance on Regulatory Codes (1976:725) as: Such general recommendations on the application of regulations that stipulate how someone can or should act in a certain respect.

##### A1.2 Swedish Radiation Safety Authority Regulatory Code SSMFS 2008:21

The Swedish Radiation Safety Authority’s regulations concerning safety in connection with the disposal of nuclear material and nuclear waste;<sup>12</sup> issued on 19 December 2008.

On the basis of Sections 20a and 21 of the Nuclear Activities Ordinance (1984:14), the Swedish Radiation Safety Authority hereby issues the following regulations.

#### Application

**Section 1** These regulations apply to facilities for the disposal of nuclear material and nuclear waste (repositories).

The regulations do not apply to facilities for landfill disposal of low-level nuclear waste under Section 16 of the Nuclear Activities Ordinance (1984:14).

The regulations contain supplementary provisions to the Swedish Radiation Safety Authority’s regulations (SSMFS 2008:1) concerning safety in nuclear facilities.

#### Barriers and their Functions

**Section 2** Safety after the closure of a repository shall be maintained through a system of passive barriers.

**Section 3** The function of each barrier shall be to, in one or several ways, contribute to the containment and prevention or retention of dispersion of radioactive substances, either directly or indirectly by protecting other barriers in the barrier system.

**Handling in SR-PSU:** The ways the barriers contribute to safety are discussed in Section 11.3.4. Three residual scenarios have also been selected and evaluated to show the importance of different barriers. In general, most of the safety assessment is aimed at demonstrating barrier safety.

---

<sup>12</sup> These regulations and the general advice were issued previously in the Swedish Nuclear Power Inspectorate’s Regulatory Code (SKIFS 2002:1).

**Section 4** A deficiency in any of the repository's barrier functions that is detected during the construction or operational surveillance of the repository, and that can lead to a deterioration in safety after closure in addition to that anticipated in the safety analysis report<sup>13</sup>, shall be reported to the Swedish Radiation Safety Authority without unnecessary delay<sup>14</sup>. The same applies if such a deficiency is suspected to occur or if it is suspected that such a deficiency may possibly occur in the future.

**Handling in SR-PSU:** This is discussed in Chapter 11.

## Design and Construction

**Section 5** The barrier system shall be able to withstand such features, events and processes that can affect the post-closure performance of the barriers.

**Handling in SR-PSU:** The overall purpose of the safety assessment can be said to demonstrate this point.

**Section 6** The barrier system shall be designed and constructed taking into account the best available technique<sup>15</sup>.

**Handling in SR-PSU:** The facility is designed in accordance with the regulatory framework in effect when the facility was built. In connection with future extensions, major facility alterations and closure, BAT will be applied and optimisation against calculated risk will be implemented. The issue of BAT is addressed in Section 11.5 and in SKBdoc 1415420.

**Section 7** The barrier system shall comprise several barriers so that, as far as possible, the necessary safety is maintained despite a single deficiency in a barrier.

**Handling in SR-PSU:** This issue is addressed in several of the analyses described in Chapter 9. In particular, a set of calculation cases to illustrate this issue is presented in Section 9.4.

**Section 8** The impact on safety of measures adopted to facilitate the monitoring or retrieval of disposed nuclear material or nuclear waste from the repository, or to make access to the repository difficult, shall be analysed and reported to the Swedish Radiation Safety Authority.

**Handling in SR-PSU:** This relates to the design of the repository and is not part of SR-PSU.

## Safety analysis

**Section 9** In addition to the provisions contained in Chapter 4, Section 1 of the Swedish Radiation Safety Authority's regulations (SSMFS 2008:1) concerning safety in nuclear facilities, the safety analyses shall also comprise features, events and processes that can lead to the dispersion of radioactive substances after closure, and such analyses shall be made before repository construction, before repository operation and before repository closure.

**Handling in SR-PSU:** The systematic management in a database of the mentioned features, events and processes is described in Chapter 3 and in the FEP report. The detailed management of several of these factors is discussed throughout the report.

**Section 10** A safety analysis shall comprise the requisite duration of barrier functions, though a minimum of ten thousand years.

**Handling in SR-PSU:** The timescales of relevance for SR-PSU are discussed in Section 2.3.1. The safety assessment covers the period up to 100,000 years after closure of SFR.

---

<sup>13</sup> Cf Chapter 4, Section 2 of the Swedish Radiation Safety Authority's regulations (SSMFS 2008:1) concerning safety in nuclear facilities.

<sup>14</sup> Cf Chapter 2, Section 3 of the Swedish Radiation Safety Authority's regulations (SSMFS 2008:1) concerning safety in nuclear facilities.

<sup>15</sup> Cf Chapter 2, Section 3 of the Swedish Environmental Code.

## Safety analysis reports

**Section 11** The safety analysis report for a repository shall, in addition to what is required by Chapter 4, Section 2 of the Swedish Radiation Safety Authority's regulations (SSMFS 2008:1) concerning safety in nuclear facilities, contain the information shown in Appendix 1 of these regulations and which concerns the period of time following closure.

Prior to repository closure, the safety analysis report shall be renewed and subjected to a safety review in accordance with Chapter 4, Section 3 of the Swedish Radiation Safety Authority's regulations (SSMFS 2008:1) concerning safety in nuclear facilities and shall be reviewed and approved by the Swedish Radiation Safety Authority.

## Exemptions

**Section 12** If there are particular grounds, the Swedish Radiation Safety Authority may grant exemptions from these regulations if this can be done without circumventing the aim of the regulations and on the condition that safety can be maintained.

### A1.3 Excerpts from appendix and the general advice on SSMFS 2008:21

This section contains excerpts from the Swedish Radiation Safety Authority's general advice on the application of the regulations (SSMFS 2008:21) concerning safety in connection with the disposal of nuclear material and nuclear waste. The following is the unabbreviated recommendations relevant to Sections 9 and 10 and Appendix of SSMFS 2008:21, i.e. those sections that concern the safety assessment.

#### Section 9 and Appendix (see Appendix A1)

The safety of a repository after closure is analysed quantitatively, primarily by estimating the possible dispersion of radioactive substances and how it is distributed over time for a relevant selection of potential future sequences of events (scenarios). The purpose of the safety analysis is to show, inter alia, that the risks from these scenarios are acceptable in relation to the requirements on the protection of human health and the environment imposed by the Swedish Radiation Safety Authority (SSMFS 2008:37). The safety analysis should also aim to provide a basic understanding of repository performance during different time periods and to identify requirements regarding the performance and design of different repository components.

A *scenario* in the safety analysis comprises a description of how a given combination of external and internal conditions affects repository performance.

Two groups of such conditions are:

- external conditions in the form of features, events and processes which occur outside repository barriers; these include climate changes and their consequential impact on the repository environment, such as permafrost, glaciation, land subsidence, land uplift as well as the impact of human activities, and
- internal conditions in the form of features, events and processes which occur inside the repository; examples of such conditions are properties including defects, nuclear material, nuclear waste and engineered barriers and related processes, as well as properties of the surrounding geological formation and related processes.

Based on an analysis of the probability of occurrence of different types of scenarios in different time periods, scenarios with a significant impact on repository performance should be divided into different categories:

- main scenario,
- less probable scenarios,
- other scenarios or residual scenarios.

The **main scenario** should be based on the probable evolution of external conditions and realistic, or where justified, conservative assumptions with respect to the internal conditions. It should comprise future external events which have a significant probability of occurrence or which cannot be shown to have a low probability of occurrence during the period of time covered in the safety analysis. Furthermore, it should as far as possible be based on credible assumptions with respect to internal conditions, including substantiated assumptions concerning the occurrence of manufacturing defects and other imperfections, and which allow for an analysis of the repository barrier performance (for example, it is insufficient to always base the analysis on leaktight waste containers over an extended period of time, even if this can be shown to be the most probable case). The main scenario should be used as the starting point when analysing the impact of uncertainties (see below), which means that the analysis of the main scenario also includes a number of calculation cases.

**Less probable scenarios** should be prepared for the evaluation of scenario uncertainty (see also below). This includes variations of the main scenario with alternative sequences of events and periods of time as well as scenarios that take into account the impact of future human activities, such as damage inflicted on barriers. (Detriment to humans intruding into the repository is illustrated by residual scenarios; see below.) An analysis of less probable scenarios should include analyses of uncertainties that are not evaluated within the framework of the main scenario.

**Residual scenarios** should include sequences of events and conditions that are selected and studied independently of probabilities in order to, inter alia, illustrate the significance of individual barriers and barrier functions. The residual scenarios should also include cases to illustrate detriment to humans intruding into the repository as well as cases to illustrate the consequences of an unclosed repository that is not monitored.

**Handling in SR-PSU: The method for selection of scenarios and the selected scenarios are presented in Chapter 7.**

Lack of knowledge and other uncertainties in the calculation presumptions (assumptions, models, data) are in this context denoted as **uncertainties**. These uncertainties can be classified as follows:

- scenario uncertainty: uncertainty with respect to external and internal conditions in terms of type, degree and time sequence,
- system uncertainty: uncertainty as to the completeness of the description of the system of features, events and processes used in the analysis of both individual barrier performance and the performance of the repository as a whole,
- model uncertainty: uncertainty in the calculation models used in the analysis,
- parameter uncertainty: uncertainty in the parameter values (input data) used in the calculations,
- spatial variation in the parameters used to describe the barrier performance of the rock (primarily with respect to hydraulic, mechanical and chemical conditions).

There are often no clear boundaries between the different types of uncertainties. The most important requirement is that the uncertainties are to be described and handled in a consistent and structured manner.

The evaluation of uncertainties is an important part of the safety analysis. This means that uncertainties should be discussed and examined in depth when selecting calculation cases, calculation models and parameter values, as well as in the assessment of calculation results.

**Handling in SR-PSU: The management of uncertainties permeates the safety assessment. A plan for the management of uncertainties is given in Section 2.6. Uncertainties in the description of the future evolution of the repository are addressed by analysis of a number of scenarios identified in Chapter 7. Probabilistic calculations are carried out to deal with uncertainties in certain parameter values.**

The assumptions and calculation models used should be carefully selected with respect to the principle that the application and selection should be justified by means of a discussion of alternatives and with reference to science. In cases where there is doubt as to the applicability of a model, several models should be used to illustrate the impact of the uncertainty involved in the choice of model.

**Handling in SR-PSU:** This matter is mainly addressed in the **Process reports** and the **Biosphere synthesis report** and, for external influences, in the **Climate report**. A structured account of important selected models is given in the **Model summary report**.

Both deterministic and probabilistic methods should be used so that they complement each other and, consequently, provide as comprehensive a picture of the risks as possible.

**Handling in SR-PSU:** Most of the calculations in SR-PSU are probabilistic. Probabilistic calculations are used essentially as a means of handling data uncertainty and spatial variability in modelling radionuclide transport and dose. For some cases deterministic calculations are performed.

The *probabilities* of the scenarios and calculation cases actually occurring should be estimated as far as possible in order to calculate risk. Such estimates cannot be exact. Consequently, the estimates should be substantiated through the use of several methods, for example assessments by several independent experts. This can for instance be done through estimates of when different events can be expected to have occurred.

**Handling in SR-PSU:** Assessment of probabilities of scenarios is dealt with in Chapter 7 and in Chapter 10.

A number of *design basis cases* should be identified based on scenarios that can be shown to be especially important from the standpoint of risk. Together with other information, such as regarding manufacturing method and controllability, these cases should be used to substantiate the design basis, such as requirements on barrier properties.

**Handling in SR-PSU:** The safety assessment analyses the chosen design which has been evaluated and improved several times during the PSU-project. Feedback to design have been given based on the reference evolution from the aspect of BAT.

Particularly in the case of disposal of nuclear material, for example spent nuclear fuel, it should be demonstrated that criticality cannot occur in the initial configuration of the nuclear material. With respect to the redistribution of the nuclear material through physical and chemical processes, which can lead to criticality, it should be demonstrated that such redistribution is very improbable.

**Handling in SR-PSU:** The section is not applicable in the present safety assessment.

The result of calculations in the safety analysis should contain such information and should be presented in such a way that an overall judgement of safety compliance with the requirements can be made.

**Handling in SR-PSU:** This is an overall requirement on the quality of the safety reporting, which has governed the compilation of the report. Compliance is discussed in Chapter 10.

The validity of assumptions used, such as models and parameter values, should be supported, for example by citing references to scientific literature, special investigations and research results, laboratory experiments on different scales, field experiments and studies of natural phenomena (natural analogues).

**Handling in SR-PSU:** Justification of models, on the bases mentioned above, is done in the **Process reports** and the **Biosphere synthesis report**, and for external influences, in the **Climate report**. A structured account of all important models is given in the **Model summary report**. Parameter values are justified in the **Data report**.

Scientific background material, such as from expert assessments, should be documented in a traceable manner by conscientiously referring to scientific literature and other material.

**Handling in SR-PSU:** All scientific background material to the safety analysis report, which consists of first-order references, is referred to in a traceable manner. These references are found in SKB's document management system (SKBdoc) or in publicly available publications (for example books or scientific articles).

## Section 10

The time period for which safety needs to be maintained and demonstrated should be a starting point for the safety analysis. One way of discussing and justifying the establishment of the relevant time period is to start from a comparison of the hazard of the radioactive inventory of the repository with the hazard of radioactive substances occurring in nature. However, it should also be possible to take into consideration the difficulties of conducting meaningful analyses for extremely long periods of time, beyond one million years, in some other way than by demonstrating how the hazard of the radioactive substances in the repository declines over time.

In the case of a repository intended for long-lived waste, the safety analysis may need to include scenarios taking greater expected climate changes into account, primarily in the form of future glaciations. For example, the next complete glacial cycle, currently estimated to be in the order of 100,000 years, should be particularly taken into account.

**Handling in SR-PSU:** The timescale for SR-PSU is discussed in Section 2.3.1.

In the case of periods up to 1,000 years after closure, in accordance with the provisions of SSMFS 2008:37, the dose and risk calculated for current conditions in the biosphere constitute the basis for assessing repository safety and the repository's protective capabilities.

Furthermore, in the case of more extended periods of time, the assessment can be made using dose as one of several safety indicators. This should be taken into account in connection with calculations as well as presentation of analysis results. Examples of these supplementary safety indicators include the concentrations of radioactive substances from the repository which can build up in soils and near-surface groundwater as well as the calculated flow of radioactive substances to the biosphere.

**Handling in SR-PSU:** Radionuclide transport and dose calculations are described in Chapter 8 and in the **Radionuclide transport report**. Results from dose calculations are presented in Chapter 9 and in the **Radionuclide transport report**. Risk is presented in Chapter 10. Comparisons with naturally occurring U-238 and Ra-226 are done in Chapter 10.



### Appendix 1

**The following shall be reported with regard to analysis methods:**

- how one or several methods have been used to describe the passive system of barriers in the repository, its performance and evolution over time; the method or methods shall contribute to providing a clear understanding of the features, events and processes that can affect the performance of the barriers and the links between these features, events and processes,

**Handling in SR-PSU:** The method used is summarised in Chapter 2 and further elaborated in Chapter 3 and Chapter 5. The description of system evolution is related to the entire assessment and is analysed in detail as a reference evolution in Chapter 6. Variants of this evolution are discussed for a number of scenarios in Chapter 7.

- how one or several methods have been used to identify and describe relevant scenarios for sequences of events and conditions that can affect the future evolution of the repository; the scenarios shall include a main scenario that takes into account the most probable changes in the repository and its environment,

**Handling in SR-PSU:** The scenario selection method for SR-PSU is described in Section 2.4.8 and its implementation in Chapter 7.

- the applicability of models, parameter values and other assumptions used for the description and quantification of repository performance as far as reasonably achievable,

**Handling in SR-PSU:** This is done in the **Model summary report** and the **Data report**.

- how uncertainties in the description of the barrier system's functions, scenarios, calculation models and calculation parameters as well as variations in barrier properties have been dealt with in the safety analysis, including the reporting of a sensitivity analysis showing how the uncertainties affect the description of the evolution of barrier performance and the analysis of the impact on human health and the environment.

**Handling in SR-PSU:** A general description of handling of uncertainties is given in Section 2.6 and more detailed descriptions is given in background reports. Uncertainties in the description of the future evolution of the repository are addressed by analysis of a number of scenarios identified in Chapter 7. Probabilistic calculations are carried out to deal with uncertainties in parameter values. A sensitivity analysis on the parameter level is presented in the **Radionuclide transport report**.

**The following shall be reported with respect to the analysis of post-closure conditions:**

- the safety analysis in accordance with Section 9 comprising descriptions of the evolution in the biosphere, geosphere and repository for selected scenarios; the environmental impact of the repository for selected scenarios, including the main scenario, thereby considering defects in engineered barriers and other identified uncertainties.

**Handling in SR-PSU:** This is essentially the description of reference evolution for the final repository, the geosphere and the biosphere in Chapter 6 and the scenarios in Chapter 7. The final repository's environmental (radiological) impact is described in Chapter 9 and in Chapter 10.



### Compliance with requirements from SSMFS 2008:37 in SR-PSU

#### B1 Implementation SSMFS 2008:37 in the safety assessment SR-PSU

Appendix B describes how applicable regulations have been implemented in the current assessment. References to where in the current report these are addressed have been inserted in blue at relevant places.

##### B1.1 SSMFS 2008:37

SSM has issued SSMFS 2008:37 ”The Swedish Radiation Safety Authority’s Regulations concerning the Protection of Human Health and the Environment in connection with the Final Management of Spent Nuclear Fuel and Nuclear Waste”. General advice is included in the document.

Whereas the Regulations have a clear legal status, general advice are described in 1 § Ordinance on Regulatory Codes (1976:725) as: Such general recommendations on the application of regulations that stipulate how someone can or should act in a certain respect.

##### B1.2 Swedish Radiation Safety Authority Regulatory Code SSMFS 2008:37

The Swedish Radiation Safety Authority’s Regulations concerning the Protection of Human Health and the Environment in connection with the Final Management of Spent Nuclear Fuel and Nuclear Waste,<sup>16</sup> issued on 19 December 2008.

On the basis of Sections 7 and 8 of the Radiation Protection Ordinance (1988:293), the Swedish Radiation Safety Authority hereby issues the following regulations.

#### Application and definitions

**Section 1:** These regulations apply to the final management of spent nuclear fuel and nuclear waste. The regulations do not apply to landfills for low-level nuclear waste in accordance with Section 19 of the Nuclear Activities Ordinance (1984:14).

**Section 2:** In these regulations the following terms and concepts are used with the meanings specified here.

- *best available technique:* the most effective measure available to limit the release of radioactive substances and the harmful effects of releases on human health and the environment, and which does not entail unreasonable costs,
- *intrusion:* human intrusion into a repository which can affect its protective capability,
- *optimisation:* keeping the radiation doses to humans as low as reasonably achievable while taking economic and societal factors into account,
- *harmful effects* cancer (fatal and non-fatal) as well as hereditary effects in humans caused by ionising radiation, in accordance with paragraphs 47–51 in Publication 60, 1990, of the International Commission on Radiological Protection (ICRP),
- *protective capability:* the capability to protect human health and the environment from the harmful effects of ionising radiation,
- *final management:* handling, treatment, transport, interim storage prior to, and in connection with, disposal as well as the disposal itself,
- *risk:* the product of the probability of receiving a radiation dose and the harmful effects of the radiation dose.

Terms and concepts used in the Radiation Protection Act (1988:220) and the Act on Nuclear Activities (1984:3) have the same meanings in these regulations.

<sup>16</sup> These regulations and the general advice were issued previously in the Swedish Radiation Protection Authority's Regulatory Code (SSI FS 1998:1 and SSI FS 2005:5).

## Holistic approach, etc

**Section 3:** Human health and the environment shall be protected from detrimental effects of ionising radiation during the period of time when the various stages of the final management of spent nuclear fuel and nuclear waste are being implemented as well as in the future. The final management may not cause impacts on human health and the environment outside Sweden's borders that are more severe than those accepted inside Sweden.

**Section 4:** Optimisation must be performed and the best available technique shall be taken into consideration in the final management of spent nuclear fuel and nuclear waste. The collective dose, as a result of the expected outflow of radioactive substances over a period of 1,000 years after closure of a repository for spent nuclear fuel or nuclear waste shall be estimated as the sum, over 10,000 years, of the annual collective dose. The estimate shall be reported in accordance with Sections 10 to 12.

**Handling in SR-PSU:** Optimisation and BAT is discussed in Section 11.5 and in a separate document on best available technique for SFR (SKBdoc 1415420).

## Protection of human health

**Section 5:** A repository for spent nuclear fuel or nuclear waste shall be designed so that the annual risk of harmful effects after closure does not exceed  $10^{-6}$  for a representative individual in the group exposed to the greatest risk.<sup>17</sup>

The probability of harmful effects as a result of a radiation dose shall be calculated using the probability coefficients provided in the International Radiation Protection Commission's Publication 60, 1990.

**Handling in SR-PSU:** Estimating radiological risk and assessing compliance with the criterion above is one of the main purposes of SR-PSU. A summation of the total risk is given in Chapter 10 together with a discussion of compliance.

## Environmental protection

**Section 6:** The final management of spent nuclear fuel and nuclear waste shall be implemented so that biodiversity and the sustainable use of biological resources are protected against the harmful effects of ionising radiation.

**Section 7:** Biological effects of ionising radiation in the habitats and ecosystems concerned shall be described. The report shall be based on available knowledge on the ecosystems concerned and shall take particular account of the existence of genetically distinctive populations such as isolated populations, endemic species and species threatened with extinction and in general any organisms worth protecting.

**Handling in SR-PSU:** This is addressed in Chapter 10.

## Intrusion and access

**Section 8:** A repository shall be primarily designed with respect to its protective capability. If measures are adopted to facilitate access or to make intrusion more difficult, the effects on the protective capability of the repository shall be reported.

**Section 9:** The consequences of intrusion into a repository shall be reported for the different time periods specified in Sections 11 and 12.

The protective capability of the repository after intrusion shall be described.

**Handling in SR-PSU:** Intrusion is discussed in Chapter 9 and further elaborated in the **FHA report**.

---

<sup>17</sup> Facilities in operation are subject to the Swedish Radiation Safety Authority's regulations (SSMFS 2008:23) on protection of human health and the environment in connection with discharges of radioactive substances from certain nuclear facilities as well as the Swedish Radiation Safety Authority's regulations (SSMFS 2008:51 concerning basic provisions for the protection of workers and the general public in practices involving ionising radiation.

## Time periods

**Section 10:** An assessment of a repository's protective capability shall be reported for two time periods of the orders of magnitude specified in Sections 11 and 12. The description shall include a case based on the assumption that the biospheric conditions prevailing at the time when an application for a licence to construct the repository is submitted will not change. Uncertainties in the assumptions made shall be described and taken into account when assessing the protective capability.

### The first thousand years following closure of a repository

**Section 11:** For the first thousand years following repository closure, the assessment of the repository's protective capability shall be based on quantitative analyses of the impact on human health and the environment.

### Period after the first thousand years following closure of a repository

**Section 12:** For the period after the first thousand years following repository closure, the assessment of the repository's protective capability shall be based on various possible sequences for the development of the repository's properties, its environment and the biosphere.

**Handling in SR-PSU:** The reference evolution, as reported in Chapter 6, is divided into two time periods, the first 1,000 years and the period thereafter which addresses the evolution of the repository system during periods of temperate and periglacial climate. A separate scenario aimed at estimating the radiological consequences of the repository after a glaciation is evaluated as a residual scenario, see Chapter 10.

## Exemptions

**Section 13:** If there are particular grounds, the Swedish Radiation Safety Authority may grant exemptions from these regulations if this can be done without circumventing the aim of the regulations.

### B1.3 General advice on SSMFS 2008:37

The Swedish Radiation Safety Authority's general advice on the application of the regulations (SSMFS 2008:37) concerning the protection of human health and the environment in connection with the final management of spent nuclear fuel and nuclear waste.

#### Section 1: Application

This advice is applicable to final geological disposal of spent nuclear fuel and nuclear waste. The advice covers measures undertaken with a view to developing, siting, constructing, operating and closing a repository, which can have an impact on the protective capability of the repository and the environmental consequences after closure.

The advice is also applicable to measures that are to be undertaken with spent nuclear fuel and nuclear waste before disposal and which can have an impact on the protective capability of a repository and its environmental consequences. This includes activities at installations other than the repository, such as the conditioning of waste that takes place by casting waste in concrete and by encapsulation of spent nuclear fuel, as well as transports between installations and steering of waste to different repositories, including shallow land burials for low-level nuclear waste that are licenced in accordance with Section 16 of the Nuclear Activities Ordinance (1984:14). However, as is the case with the regulations, the advice is not applicable to the installation for land burial.

#### Section 2: Definitions

Terms and concepts used in the Radiation Protection Act (1988:220), the Act on Nuclear Activities (1984:3) and the Swedish Radiation Safety Authority's regulations (SSMFS 2008:37) on protection of human health and the environment in connection with final management of spent nuclear fuel and nuclear waste have the same meanings in this advice. The following definitions are also used:

- *scenario*: a description of the potential evolution of the repository given an initial state and specified conditions in the environment and their development,
- *exposure pathway*: the migration of the radioactive substances from a repository to a place where human beings are present, or where an organism covered by the environmental protection regulations is present. This includes dispersion in the geological barrier, transport with water and air flows, migration in ecosystems and uptake in human beings or organisms in the environment,
- *risk analysis*: an analysis with the aim of clarifying the protective capability of a repository and its consequences with regard to the environmental impact and the risk for human beings.

## **Sections 4, 8 and 9: Holistic approach, etc; intrusion and access**

### **Optimisation and Best Available Technique**

The regulations require optimisation to be performed and the best available technique to be taken into account. Optimisation and best available technique should be applied in parallel with a view to improving the protective capability of the repository.

Measures for optimisation of a repository should be evaluated on the basis of calculated risks.

Application of best available technique in connection with disposal means that the siting, design, construction and operation of the repository and appurtenant system components should be carried out so as to prevent, limit and delay releases from both engineered and geological barriers as far as is reasonably possible. When striking balances between different measures, an overall assessment should be made of their impact on the protective capability of the repository.

In cases where considerable uncertainty is attached to the calculated risks, for instance in analyses of the repository a long time after closure, or analyses made at an early stage of the development work with the repository system, greater weight should be placed on best available technique.

In the event of any conflicts between application of optimisation and best available technique, priority should be given to best available technique.

Experiences from recurrent risk analyses and the successive development work with the repository should be used when applying optimisation and best available technique.

**Handling in SR-PSU:** Optimisation and BAT is discussed in Chapter 11 and in a separate document on best available technique (SKBdoc 1415420).

### **Collective dose**

The regulations require an account of the collective dose from releases taking place during the first thousand years after closure. As far as concerns disposal, the collective dose should also be used in comparisons between alternative repository concepts and sites. The collective dose need not be reported if the repository concept entails a complete containment of the spent nuclear fuel or nuclear waste in engineered barriers during the first thousand years after closure.

**Handling in SR-PSU:** Estimated collective doses are provided in Chapter 10.

### **Occupational radiation protection**

An account should be given of measures undertaken for radiation protection of workers that may have a negative impact on the protective capability of the repository or make it more difficult to assess.

**Handling in SR-PSU:** No such measures have been identified in SR-PSU.

### **Future human action and the preservation of information**

When applying best available technique, consideration should also be given to the possibility to reduce the probability and consequences of inadvertent future human impact on the repository, for instance inadvertent intrusion. Increased repository depth and avoidance of sites with extractable mineral assets may, for instance, be considered to reduce the probability of unintentional human intrusion.

**Handling in SR-PSU:** In the document on site selection (SKB 2013b) the ore potential in the area is discussed. When selecting the depth of the extension, inadvertent intrusion is one of the relevant parameters to regard.

Preservation of knowledge about the repository could reduce the risk of future human impact. A strategy for preservation of information should be produced so that measures can be undertaken before closure of the repository. Examples of information that should be taken into consideration include information about the location of the repository, its content of radioactive substances and its design.

**Handling in SR-PSU:** The production of such a strategy is not an issue for the safety assessment. As documented elsewhere in SKB's licence application, information about the repository will be collected and stored during construction, operation and closure of the repository according to applicable legal requirements. A strategy for preservation of information after closure will be developed by SKB, to some extent as part of international cooperation on this subject, in reasonable time before closure.

## **Sections 5–7: Protection of human health and the environment**

### **Risk for the individual from the general public**

#### *The relationship between dose and risk*

Under the regulations, the recommendations of the International Commission on Radiological Protection (ICRP) are to be used when calculating the harmful effects of a radiation dose. According to ICRP Publication 60, 1990, the factor for conversion of effective dose to risk is 7.3 per cent per sievert.

#### *The regulations' criterion for individual risk*

Under the regulations, the risk for harmful effects for a representative individual in the group exposed to the greatest risk (the most exposed group) shall not exceed  $10^{-6}$  per year. Since the most exposed group cannot be described in an unambiguous way, the group should be regarded as a way of quantifying the protective capability of the repository.

One way of defining the most exposed group is to include the individuals who receive a risk in the interval from the highest risk down to one-tenth of this risk. If a larger number of individuals can be considered to be included in such a group, the arithmetic average of individual risks in the group should be used for demonstrating compliance with the criterion for individual risk contained in the regulations. One example of this kind of exposure situation is a release of radioactive substances into a large lake that can be used as a source of drinking water and for fishing.

If the exposed group only consists of a few individuals, the criterion of the regulations for individual risk can be considered as being complied with if the highest calculated individual risk does not exceed  $10^{-5}$  per year. An example of a situation of this kind might be if consumption of drinking water from a drilled well is the dominant exposure pathway. In such a calculation example, the choice of individuals with the highest risk load should be justified by information about the spread in calculated individual risks with respect to assumed living habits and places of stay.

**Handling in SR-PSU:** Four groups of exposed populations are used in the assessment. Different exposure pathways are mapped to the exposed groups which are used as bounding cases to identify most exposed group (described in Chapter 7 and in the **Biosphere synthesis report** and SKB (2014b)). Risk evaluation for the most exposed group is described in Chapter 10 of the present report.

#### *Averaging risk over a lifetime*

The individual risk should be calculated as an annual average on the basis of an estimate of the lifetime risk for all relevant exposure pathways for every individual. The lifetime risk can be calculated as the accumulated lifetime dose multiplied by the conversion factor of 7.3 per cent per sievert.

**Handling in SR-PSU:** Doses are calculated as an annual average on the basis of a 50-year period (~ an adult life time) for all relevant exposure pathways for a representative individual of the most exposed group. The lifetime dose is converted to risk, (i.e. the probability of cancer or hereditary genetic damage), using the conversion factor of 7.3 per cent per Sievert (Chapter 10).

### *Averaging risk between generations*

Deterministic and probabilistic calculations can both be used to illustrate how risk posed by the repository develops over time. However, a probabilistic analysis can in certain cases give an insufficient picture of how an individual detrimental event, for instance, a major earthquake, would affect the risk for a particular generation. The probabilistic calculations should in such cases be supplemented as specified in Appendix 1.

**Handling in SR-PSU:** Risk has primarily been calculated based on a probabilistic analysis (of parameter uncertainty). However to make sure that the risk is not significantly diluted between generations these calculations have been contrasted against deterministic calculations using best estimates for all parameters. Calculations of the risk associated with earthquakes have been made ensuring that no dilution of risk between generations occurs (i.e. the risk of individual simulations has been summed – not averaged). Further described in Chapter 10.

### **Selection of scenarios**

An assessment of the protective capability of a repository and the environmental consequences should be based on a set of scenarios that together illustrate the most important courses of development of the repository, its surroundings and the biosphere.

### **Dealing with climate evolution**

Taking into consideration the great uncertainties associated with the assumptions concerning climate evolution in a remote future and to facilitate interpretation of the risk to be calculated, the risk analysis should be simplified to include a few possible climate evolutions.

A realistic set of biosphere conditions should be associated with each climate evolution. The different climate evolutions should be selected so that they together illustrate the most important and reasonably foreseeable sequences of future climate states and their impact on the protective capability of the repository and their environmental consequences. The choice of the climate evolutions that serve as the basis for the analysis should be based on a combination of sensitivity analyses and expert judgements. Additional guidance is provided in the section containing advice on Sections 10 to 12.

The risk posed by the repository should be calculated for each assumed climate evolution by summing the risk contributions from a number of scenarios that together illustrate how the more or less probable courses of development in the repository and the surrounding rock affect the repository's protective capability and environmental consequences. The calculated risk should be reported and evaluated separately for each climate evolution in relation to the criterion of the regulations for individual risk. Hence, it should be shown that the repository complies with the risk criterion for each of the alternative climate evolutions. If a lower probability than one (1) is stated for a particular climate evolution, this should be justified, for instance by expert judgements.

**Handling in SR-PSU:** The handling of climate-related features, events and processes of importance for the safety after closure are described in Section 3.5.1. The SR-PSU safety assessment includes four future climate evolutions, or climate cases, which represent the expected range within which climate and climate-related issues of importance for the long-term safety can vary on the timescales analysed in SR-PSU, i.e. during the next 100,000 years, see Section 6.2. The most probable climate evolution for the period until the next glaciation in Forsmark is covered by the *global warming* and *early periglacial* variants of the main scenario. A residual scenario covering the potential influence of the warmest and wettest climate conditions included in the set of climate cases included in SR-PSU is also included, the *extended global warming scenario*. The total risk for the main scenario is calculated as a weighted sum of the risk contribution from each climate variant of the main scenario with the contributions from the less probable scenarios, see Section 10.3. Since the calculated maximum dose for the *extended global warming scenario* is less than for the main scenario, the total risk including contributions from the less probable scenarios has not been calculated for this scenario. Current scientific understanding suggests that the global climate evolution during the next 100,000 years will differ from the last glacial cycle due to human activities in combination with known small variations in the incoming solar radiation. The *Weichselian glacial cycle climate case*,



which is based on a reconstruction of the last glacial cycle, is therefore given less weight in the SR-PSU safety assessment which covers this period. It can however not be ruled out that a glaciation will occur in Forsmark during the period from 52 000 to 102 000 AD. The structural integrity of the waste vaults cannot be expected to remain intact after a glaciation and thus the evolution of the repository system described by the reference evolution is no longer relevant. Therefore, the risk associated with glacial and postglacial climate conditions is evaluated based on a cautiously simplified description of the repository system evolution during and after a glaciation, see Section 7.7.8. For the evaluation of radiological risk, SKB has assumed a probability of 1 (one) for each safety assessment scenario related to climate (*global warming* and *early periglacial* variants of the main scenario, *extended global warming scenario* and *glaciation and postglacial conditions scenario*).

### **Future human action**

A number of future scenarios for inadvertent human impact on the repository should be presented. The scenarios should include a case of direct intrusion in connection with drilling in the repository and some examples of other activities that indirectly lead to a deterioration in the protective capability of the repository, for example by changing the hydrological conditions or groundwater chemistry in the repository or its surroundings. The selection of intrusion scenarios should be based on present living habits and technical prerequisites and take into consideration the repository's properties.

The consequences of the disturbance for the repository's protective capability should be illustrated by calculations of the doses for individuals in the most exposed group and be reported separately from the risk analysis for the undisturbed repository. The results should be used to illustrate conceivable countermeasures and to provide a basis for the application of best available technique (see the advice on optimisation and best available technique).

An account need not be given of the direct consequences for the individuals intruding into the repository.

**Handling in SR-PSU:** Three FHA scenarios have been evaluated: drilling into the repository, water management and undergrounds construction. Calculation of doses to most exposed group has been performed for the drilling scenario, including direct exposure to drilling personnel and exposure by utilising a landfill containing radionuclides from the repository for either construction work or for growing vegetables (further described in Chapter 7, 9 and the **FHA report**).

### **Special scenarios**

For repositories primarily based on containment of the spent nuclear fuel or nuclear waste, an analysis of a conceivable loss during the first thousand years after closure of one or more barrier functions of key importance for the protective capability should be presented separately from the risk analysis. The intention of this analysis should be to clarify how the different barriers contribute to the protective capability of the repository.

**Handling in SR-PSU:** Not relevant for SR-PSU, three residual scenarios have, however, been selected to show the importance of different barriers.

### **Biosphere conditions and exposure pathways**

The future biosphere conditions for calculations of consequences for human beings and the environment should be selected in agreement with the assumed climate state. Unless it is clearly inconsistent, however, today's biosphere conditions at the repository and its surroundings should be evaluated, i.e. agricultural land, forest, wetland (mire), lake, sea or other relevant ecosystems. Furthermore, consideration should be taken to land uplift (or subsidence) and other predictable changes.

The risk analysis can include a limited selection of exposure pathways, although the selection of these should be based on an analysis of the diversity of human use of environmental and natural resources which can occur in Sweden today. Consideration should also be taken to the possibility of individuals being exposed to combinations of exposure pathways within and between different ecosystems.

**Handling in SR-PSU:** In the global warming case, present biosphere conditions are applied for all ecosystems. The effect of warmer or colder climate on the biosphere is considered in the early periglacial and extended global warming cases. An exposure pathway analysis has been performed in the project and the identified exposure pathways have been included for one or more of the four groups identified to be used as bounding cases of most exposed group (further described in Chapter 7 and in the **Biosphere synthesis report**).

### **Environmental protection**

The description of exposure pathways as mentioned above should also include exposure pathways to certain organisms in the above-mentioned ecosystems that should be included in the risk analysis. The concentration of radioactive substances in soil, sediment and water should be accounted for where relevant for the respective ecosystem.

When a biological effect for the identified organisms can be presumed, an evaluation should be made of the consequence this may have for the affected ecosystems, with the view to facilitating an assessment of impact on biological diversity and sustainable use of the environment.

The analysis of consequences for organisms in “today’s biosphere”, carried out as above, should be used for the assessment of environmental consequences in a long-term perspective. For assumed climates, where the present biosphere conditions are clearly unrealistic, for example during a colder climate with permafrost, it is sufficient to conduct a general analysis based on knowledge currently available about applicable ecosystems. Additional advice is contained in Appendix 2.

**Handling in SR-PSU:** Dose rates to biota in marine, limnic and terrestrial ecosystems have been estimated and compared to internationally used screening values (further described in Chapter 9). Since the estimated dose rates were all well below the screening values (see Chapter 9 and the **Radionuclide transport report**) no effects of concern are expected and therefore no evaluation of the consequences has been performed.

### **Reporting of uncertainties**

Identification and assessment of uncertainties in (for instance) site-specific and generic data and models should take place in accordance with the instructions given in the general advice for the Swedish Radiation Safety Authority’s regulations (SSMFS 2008:21) concerning safety in connection with the disposal of nuclear material and nuclear waste. The different categories of uncertainties specified there should be evaluated and reported on in a systematic way and evaluated on the basis of their importance for the result of the risk analysis. The report should also include a motivation of the methods selected for dealing with different types of uncertainties, for instance in connection with the selection of scenarios, models and data. All calculation steps with appurtenant uncertainties should be reported on.

Peer review and expert panel elicitation may be used in cases where the basic data is insufficient to strengthen the credibility of assessments of uncertainties in matters of great importance for assessing the protective capability of the repository.

**Handling in SR-PSU:** The approach to handling of uncertainties is described in Chapter 2.

### **Sections 10 to 12: Time periods**

Two time periods are defined in the regulations: the period up to one thousand years after closure and the subsequent period.

For longer time periods, the result of the risk analysis should be successively regarded more as an illustration of the protective capability of the repository given certain assumptions.

### **Limitation of the risk analysis in time**

The following principles should provide guidance for the limitation of the risk analysis in time:

1. For a repository for spent nuclear fuel or other long-lived nuclear waste, the risk analysis should at least cover approximately one hundred thousand years or the period for a glaciation cycle to illustrate reasonably predictable external strains on the repository. The risk analysis should thereafter be extended in time for as long as it provides important information about the possibility of improving the protective capability of the repository, although for a maximum time period of up to one million years.
2. For repositories for nuclear waste other than those referred to in item 1, the risk analysis should at least cover the period of time until the expected maximum consequences in terms of risk and environmental impact have taken place, although for a maximum time period of up to one hundred thousand years. The arguments for the selected limitations of the risk analysis should be presented.

The arguments for the selected limitations of the risk analysis should be presented.

**Handling in SR-PSU:** An assessment time-period of 100,000 years is selected, see Section 2.3.1.

### **Reporting on the first thousand years after closure**

The period of time of one thousand years should be regarded as the approximate time period for which a risk analysis can be carried out with a high level of credibility with regard to many factors, such as climate and biosphere conditions. For this time period, available measurement data and other knowledge about the initial conditions should be used for a detailed analysis and description of the protective capability of the repository and the evolution of its surroundings.

The conditions and processes during the early evolution of the repository which can affect its long-term protective capability should be described in as much detail as possible. Examples of such conditions and processes include the resaturation of the repository, stabilisation of hydrogeological and geochemical conditions, thermal evolution and other transient events.

Biosphere conditions and known trends in the surroundings of the repository should also be described in detail, partly to be able to characterise “today’s biosphere” (see advice for Section 5), and partly to be able to characterise the possible conditions applicable to a conceivable early release from the repository. Known trends here for instance refer to land uplift (or subsidence), any trends in climate evolution and appurtenant changes in use of land and water.

**Handling in SR-PSU:** The first 1,000 years is reported separately in the reference evolution.

### **Reporting on very long time periods**

*Up to one hundred thousand years*

Reporting should be based on a quantitative risk analysis in accordance with the advice on Sections 5 to 7. Supplementary indicators of the repository’s protective capability, such as barrier functions, radionuclide fluxes and concentrations in the environment, should be used to strengthen the confidence in the calculated risks.

The given period of time of one hundred thousand years is approximate and should be selected in such a way so that the effect of expected large climate changes, for instance a glaciation cycle, on the protective capability of the repository, and the consequences for the surroundings can be illustrated.

**Handling in SR-PSU:** This is reported in Chapter 10.

### *Beyond one hundred thousand years*

The risk analysis should illustrate the long-term evolution of the repository's barrier functions and the impact of major external disturbances on the repository, such as earthquakes and glaciations. Taking into consideration the increasing uncertainties over time, the calculation of doses to people and the environment should be made in a simplified way with respect to climate development, biosphere conditions and exposure pathways. The climate evolution may be described as an idealised repetition of identical glaciation cycles.

A strict quantitative comparison of calculated risk with the criterion for individual risk contained in the regulations is not meaningful. The assessment of the protective capability of the repository should instead be based on reasoning on the calculated risk together with several supplementary indicators of the protective capability of the repository, such as barrier functions, radionuclide fluxes and concentrations in the environment. If the calculated risk exceeds the criterion of the regulations for individual risk or if there are other indications of substantial disruptions to the protective capability of the repository, the underlying causes of this should be reported on as well as possible measures to improve the protective capability of the repository.

**Handling in SR-PSU:** Based on the general advice on Sections 10 to 12, an assessment time period of 100,000 years has been used. The maximum radiological consequence takes place during this time period. In addition a residual scenario defined to study the radiological consequence during post-glacial conditions shows that also the radiological consequence after a glaciation is negligible.

### **Summary of arguments for demonstrating compliance with the requirements of the regulations**

The reporting should include an account of how the principles for optimisation and the best possible technique have been applied in the siting and design of the repository and appurtenant system components, and how quality assurance has been used in the work with the repository and appurtenant risk analyses.

**Handling in SR-PSU:** Issues regarding siting is discussed in the document on site selection (SKB 2013b) and BAT is discussed the document on best available technique for SFR (SKBdoc 1415420).

The arguments for the protective capability of a repository should be evaluated and reported on in a systematic way. The reporting should include a logically structured argument for the protective capability of the repository with information on calculated risks, uncertainties in the calculations made and the credibility of the assumptions made. To provide a good understanding of the results of the risk analysis, it should be evident how individual scenarios contribute to the level of risk posed by the repository.

**Handling in SR-PSU:** This is addressed in Chapter 10.

### Advice on the averaging of risk between generations

For certain exposure situations, the annual risk, calculated as an average of all conceivable outcomes of a probabilistic risk assessment, provides an insufficient picture of how risk is allocated between future generations.

This particularly applies to events which:

- can be assessed as leading to doses during a limited period of time in relation to the time period covered by the risk analysis, and
- if they arise, can be assessed as giving rise to a conditional individual risk exceeding the criterion contained in the regulations for individual risk, and
- can be assessed as having such a high probability of occurring during the time period covered by the risk analysis that the product of this probability and the calculated conditional risk is of the same order of magnitude as, or exceeds, the criterion for individual risk contained in the regulations.

For exposure situations of this kind, a probabilistic calculation of risk should be supplemented by calculating the risk for the individuals who are assumed to live after the event has taken place and who are affected by its calculated maximum consequence. The calculation can for instance be made by illustrating the significance of an event occurring at different points in time ( $T_1$ ,  $T_2$  [...],  $T_n$ ), taking into consideration the probability of the event occurring during the respective time interval ( $T_0$  to  $T_1$ ,  $T_0$  to  $T_2$  [...],  $T_0$  to  $T_n$ , where  $T_0$  corresponds to the time of closure of the repository). The results from these, or similar calculations, can in this way be expected to provide an illustration of the effects of the spreading of risk between future generations and should, together with other risk calculations, be reported on and evaluated in relation to the regulations' criterion for individual risk.

**Handling in SR-PSU:** Risk dilution is addressed in Chapter 10.



### Advice on the evaluation of environmental protection

The organisms included in the analysis of environmental impact should be selected on the basis of their importance in the ecosystems, but also in line with their protection value according to other biological, economic or conservation criteria. Other biological criteria refer (among other things) to genetic distinctiveness and isolation (for example, presently known endemic species). Economic criteria refer to the importance of the organisms for establishment of different kinds of livelihood (for instance, hunting and fishing). Conservation criteria refer to possible protection by current legislation or local regulations. Other aspects, such as cultural history, for instance, should also be taken into consideration when identifying such organisms.

An assessment of effects of ionising radiation in selected organisms deriving from radioactive substances that may have spread from a repository can be made on the basis of the general guidance provided by Publication 91 from the International Commission on Radiological Protection (ICRP).<sup>1</sup> The applicability of the knowledge and databases used for the analyses of dispersion and transfer of radioactive substances in ecosystems and for analysing the effects of radiation on different organisms should be assessed and reported on.

**Handling in SR-PSU:** The selection of species is based on recommendations in a former study (Jaeschke et al. 2013). The environmental protection related to SFR is discussed in Chapter 10 and is described in the **Radionuclide transport report** and the **Biosphere synthesis report**.





### Handling of injunctions from SAR-08

#### C1 Response to the SAR-08 injunction

SKB submitted the safety assessment SAR-08 (SKB 2008a) on 30 April 2008. In December 2009, the Swedish Radiation Safety Authority decided to (SSM 2009):

- approve Svensk Kärnbränslehantering AB's (SKB's) safety analysis report (SAR-08) for the final repository for radioactive operational waste (SFR 1) as regards the waste vaults BLA, 1BTF, 2BTF and silo,

and to:

- enjoin SKB to present a concrete and coherent plan for the measures which, in accordance with applicable radiation safety conditions, need to be taken upon closure of the facility by not later than 30 April 2010,
- enjoin SKB to supplement the safety analysis report – in conjunction with the submission of an application for extension of the final repository, but not later than 31 December 2013 – with the following as a basis for an evaluation of reported dose and risk calculations:
  - an account of the anticipated barrier degradation in the repository part BMA based on all reasonably probable degradation processes,
  - a sensitivity analysis of the risk and importance of changed redox conditions at repository depth, and
  - a detailed justification of the applicability of the assumed parameter distributions associated with the groundwater flow in the repository and its vicinity, plus a well-founded discussion of which model variants have been rejected.

SKB responded to the first part of the injunction on 30 April 2010 (SKBdoc 1240154). After SKB had decided that an application for an extended SFR would be submitted on 31 March 2014 instead of 31 December 2013, SKB applied in August 2013 for an extension of the deadline for responding to the second part of the injunction. On 19 September 2013, SSM decided to extend the deadline for responding to the injunction to March 2014. In March 2014 (SKBdoc 1386344) SKB responded to the second part of the injunction.

#### C2 Short summary of the 2010 response

In the 2010 response (SKBdoc 1240154), a plan for closure of the facility, was presented. The closure plan included the following components:

- Plugs, according to the reference design as presented in the SAR-08.
- Backfilling of the waste vaults, in SAR-08, as in the current assessment, all waste vaults except BLA was assumed to be backfilled.
- The waste packages in BMA was not assumed to be embedded in grout in the assessment and hence not required in the closure plan. It was however concluded that this could be advantageous from a hydraulic perspective.
- Backfilling of the tunnel system is planned to be done with, for example, crushed rock. Sealing of survey borehole is to be made so that the properties of these do not affect the groundwater flow.

The closure plan has since then been further detailed (SKBdoc 1358612).

#### C3 Short summary of the 2014 response

In the 2014 response (SKBdoc 1386344), results from studies related to concrete degradation, changed redox conditions and parameter distributions associated with groundwater flow, were included. Results and conclusions that were included in the response have been part of the present assessment.

### **C3.1 Expected barrier degradation in BMA**

A detailed response to the part of the injunction that pertains to the expected barrier degradation in BMA was presented. The response was based on material produced within the current assessment (especially Höglund (2014), the reference evolution reported in Chapter 6, and the **Barrier process report**).

### **C3.2 Risk and importance of changed redox conditions**

A detailed response to the part of the injunction that pertains to the risk and consequence of changed redox conditions at repository depth was presented. The part of the response related to the risk for changing redox conditions can be found in Duro et al. (2012) and in the reference evolution reported in Chapter 6. Although these studies indicate that the risk for oxidising conditions in the repository is low, a residual scenario is included in the current assessment, see Chapter 7. The consequence of changing redox conditions is reported in Chapter 9 and in the **Radionuclide transport report**.

The conclusion is that the risk of changed redox conditions is small and that the consequence in terms of radiological risk in the event of oxidising conditions is low.

### **C3.3 Justification of the parameter distributions associated with the groundwater flow in the repository**

A detailed response to the part of the injunction that pertains to the choice of the parameter distributions associated with the groundwater flow in the repository was presented. After SAR-08, extensive work has been carried out within the discipline of hydrogeology. Supplementary site investigations (SKB 2013e) have been conducted, and an updated hydrogeological model has been constructed (Odén et al. 2014). This additional site knowledge supports the suitability of the assumed parameter distributions in SAR-08, and implies that other model variants can be rejected. The new model is well suited for providing material in support of a response to the injunction, since it describes the hydrogeological conditions in the existing SFR, as well as in the area intended for the SFR Extension Project.

The conclusions of the flow simulations in the new model are that the results presented in SAR-08 are in good agreement with the conclusions that can be drawn from the new analyses.

### **Handling of review comments from SAR-08 in SR-PSU**

This document is the SSM's review of SAR-08, translated into English by SKB and extended with a section: "Handling in SR-PSU", marked in [blue](#). For the sake of clarity, a table of contents has also been added. All references mentioned in the review comments are listed in Section D4.



# Contents

<b>D1</b>	<b>Introduction</b>	<b>421</b>
D1.1	Background	421
	D1.1.1 Licensing of SFR-1	421
	D1.1.2 Review of safety analysis report 2001	422
D1.2	Purpose of this review	422
D1.3	Execution of the review	423
<b>D2</b>	<b>Legal premises and other requirements</b>	<b>423</b>
D2.1	Background	423
D2.2	Operating conditions issued after review of FSR 2001	423
	D2.2.1 Limits on the inventory in SFR	423
	D2.2.2 Estimation of measurement and calculation methods for radionuclides in the waste	424
	D2.2.3 Requirements on closure plan for final repository	424
	D2.2.4 Requirement on periodic safety analysis report	424
D2.3	Radiation protection requirements and safety requirements	424
<b>D3</b>	<b>Long-term function of SFR 1</b>	<b>424</b>
D3.1	Closure measures	424
	D3.1.1 Background	424
	D3.1.2 SKB's account	425
	D3.1.3 SSM's assessment of SKB's account in SAR-08	425
D3.2	Nuclide inventory and waste	426
	D3.2.1 Waste in SFR	426
	D3.2.2 Methodology for derivation of inventory of cobalt-60, cesium-137 and plutonium-239 in SFR	426
	D3.2.3 Methodology for determination of the inventory of other important radionuclides	428
	D3.2.4 Connection between operation and long-term radiation protection and safety	430
D3.3	Methodology for safety assessment	432
	D3.3.1 SKB's account	432
	D3.3.2 SSM's assessment of SKB's account in SAR-08	432
D3.4	Climate evolution	433
	D3.4.1 Background	433
	D3.4.2 SKB's account	433
	D3.4.3 SSM's assessment of SKB's account in SAR-08	434
D3.5	Selection of scenarios and scenario probabilities	438
	D3.5.1 SKB's account	438
	D3.5.2 SSM's assessment of SKB's account in SAR-08	438
D3.6	Method for consequence analysis and calculation cases	440
	D3.6.1 SKB's account	440
	D3.6.2 SSM's assessment of SKB's account in SAR-08	440
D3.7	Hydrogeology	440
	D3.7.1 SKB's account	440
	D3.7.2 SSM's assessment of SKB's account in SAR-08	441
	D3.7.3 SSM's assessment of SKB's account in SAR-08	443
D3.8	Analysis of engineered barriers	447
	D3.8.1 SKB's account	447
	D3.8.2 SSM's assessment of SKB's account in SAR-08	448
D3.9	Evolution of chemical conditions in SFR-1	450
	D3.9.1 SKB's account	450
	D3.9.2 SSM's assessment of SKB's account in SAR-08	451
D3.10	Effects of earthquakes on SFR-1	452
	D3.10.1 SKB's account	452
	D3.10.2 SSM's assessment of SKB's account in SAR-08	453

D3.11	Consequence calculations	453
D3.11.1	Modelling of the final repository	453
D3.11.2	Modelling of the geosphere	455
D3.11.3	Modelling of radionuclide flux in the biosphere	456
D3.11.4	Methods for calculation of environmental effects	459
D3.11.5	Presentation of calculation results	459
D3.12	Characterisation of risk	461
D3.12.1	SKB's account	461
D3.12.2	SSM's assessment of SKB's account in SAR-08	463
D3.13	SSM's summary assessment	465
<b>D4</b>	<b>References</b>	<b>466</b>

## Summary

In 2008, Svensk Kärnbränslehantering AB (SKB) submitted an updated safety analysis report (SAR-08) for the final repository for radioactive operational waste (SFR-1). This report has been reviewed against stipulated conditions and prescribed requirements issued by the Swedish Radiation Safety Authority (SSM).

The Authority judged that the submitted report analyses and evaluates long-term safety in a better way than previous reports. The calculation cases and scenarios that were derived and analysed were structured in a manner that satisfies the Authority's requirements and complies in essence with the directions issued by the Authority. This facilitates assessment against the prescribed risk criterion that applies to the long-term consequences of nuclear waste disposal.

The results of the dose and risk calculations that were presented were deemed to be credible for most of the aspects. SSM found that SKB and the repository satisfied the Authority's requirements regarding long-term radiation protection and safety for the repository parts BLA (rock cavern for low-level waste), 1BTF, 2BTF (the concrete tank repositories) and the silo. A remaining deficiency from the 2001 report remained however, and that was the lack of a specific and coherent account of the planned measures in conjunction with repository closure.

In the review, the Authority identified a number of other questions which SKB needed to explore further in preparation for future reports. These included remaining questions concerning degradation of the cement barriers. In its review, SSM found that this question did not affect the overall judgement of the long-term radiation safety of the repository parts 1BTF, 2BTF and the silo. SSM made this judgement primarily in view of the fact that the long-term environmental consequences were expected to be dominated by the repository part BMA (rock vault for intermediate-level waste). In its review, SSM also identified questions concerning hydrological, hydrogeochemical and biosphere modelling which SKB needed to deal with in future reports. SSM deemed these questions to be of such a character that they did not significantly affect the overall judgement for these repository parts with regard to the long-term radiation safety of the repository. Further clarifications were required from SKB to verify this judgement.

When it comes to the repository part BMA, SSM had in its review identified remaining questions that influenced the judgement about compliance with requirements. The Authority found that several of the assumptions and parameter choices used in the assessment were inadequately substantiated. This applied in particular to ambiguities regarding the expected evolution of the engineered barriers in the repository part BMA. In view of the importance of this repository part for the long-term environmental consequences, ambiguities regarding the hydrological and hydrogeochemical questions the Authority requested that priority to be given to these aspects. In view of the fact that the calculated risk was on a level with the stipulated risk criterion, SSM found that SKB needed to provide certain clarifications or supplementary information regarding these questions.

The objective of this report (appendix) is to detail how SKB has addressed in the present SR-PSU assessment the general and specific queries posed by SSM in their review of SAR-08

## D1 Introduction

### D1.1 Background

#### D1.1.1 Licensing of SFR-1

In 1983, Svensk Kärnbränslehantering AB, SKB (then SKBF), obtained a licence from the Government to build SFR-1 at the Forsmark Nuclear Power Plant (Government 1983). A final safety report, FSR, was submitted in 1987 to the Swedish Radiation Protection Authority (SSI) and the Swedish Nuclear Power Inspectorate (SKI) as a basis for the application for a licence to commission SFR-1. After regulatory review, SKB obtained a restricted operating licence in April 1988, conditional on providing certain supplementary accounts (SSI 1988 and SKI 1988).

In 1991, SKB submitted a supplementary safety assessment that was jointly reviewed by SKI and SSI. Based on this review, SSI and SKI issued supplementary operating consent where certain restrictions regarding the deposition of waste in the silo were removed (SSI 1992 and SKI 1992). After that, SKB updated the in-depth safety assessment for SFR-1 in 1993.

### **D1.1.2 Review of safety analysis report 2001**

In accordance with the operating conditions, SKB submitted in 2001 an updated safety analysis report for both the operation and the long-term radiation protection and safety of the facility (SKB 2001). The safety analysis report, hereinafter called FSR 2001, was reviewed jointly by the regulatory authorities (Dverstorp et al. 2003). One conclusion from the review was that some ambiguities existed in the fulfilment of a number of conditions and regulatory requirements, including: 1) SSI's risk-based health protection requirements, 2) the inventory, and 3) measurement methods for verifying the inventory of a number of long-lived radionuclides. After the review, SSI (SSI 2003a) and SKI (SKI 2003) therefore decided that SKB should supplement and strengthen the assessment of the repository's long-term protective capability and environmental impact.

As a consequence of the uncertainties identified, the regulatory authorities decided to prohibit further deposition of waste packages containing ion exchange resins from the cleanup of the reactor water in the pressurised water reactors at Ringhals (SSI 2003b, SKI 2003). At the same time, SSI requested that SKB should submit accounts of how radiation protection requirements were being met, including inventory limits, programmes for monitoring radionuclides in the waste, compliance with best available technology (BAT) and optimisation. These issues were followed up, and as a consequence, on 19 March 2008, SSI extended the suspension of deposition to include condensate filtration waste from Forsmarks Kraftgrupp AB (FKA) and some radioactive waste from non-nuclear activities treated at the facilities in Studsvik

SKB submitted supplements to the safety assessment at the end of 2005 (SKB 2005). However, the supplementary account that was submitted was judged to be incomplete. On 26 February 2006, SSI therefore requested SKB (SSI 2006) to supplement the account on a number of points. At this point, SKB asked (SKB 2006) and it was granted (SSI 2007) a respite on the condition that the safety analysis report to be entirely supplemented by the end of 2007. The deadline was as a consequence extended to 30 April 2008.

SKB submitted an updated safety report regarding facility design and operation (binder 1) to the regulatory authorities in January 2008 (SKB 2008a) and regarding long-term radiation protection and safety (binder 2) in April 2008 (SKB 2008b).

### **D1.2 Purpose of this review**

There are a number of reasons for this review. For one thing, according to the operating licences for SFR-1, SSI and SKI stipulated the condition that SKB must conduct a safety assessment regarding long-term safety and radiation protection for SFR 1 at least once every ten years (SKI 1988, SSI 2003c). SKB's intention with the account of this safety assessment is that it should enable the next account to be submitted at a later date than if SKB had instead just supplemented the SAFE report from 2001. An important purpose of the review is thus ultimately to determine whether SKB and the final repository fulfil the requirements for the disposal – both those that follow from the licence with associated conditions, and those that follow from the radiation protection and safety regulations that have been issued by the regulatory authorities.

Another purpose of the review is to give ground to SSM to decide whether the restrictions that currently apply to the operation of the facility can be lifted, and whether a request for reallocated inventory restrictions of radionuclides in the repository can be granted. The extent to which this is possible depends if such a change can be accommodated within the current licence.

This review report aims to provide a basis for the Authority's decision in these matters.

In addition to the requirement on an updated assessment in accordance with issued conditions, further requirements are put on periodic safety reviews of all nuclear facilities in SSMFS 2008:1 (SSM 2008). This account must also be submitted at least once every ten years. Such an account was submitted to SKI in 2005, and the authority decided that it should be supplemented by the end of 2009 (SKI 2008).



### D1.3 Execution of the review

The review was conducted by officials at the Swedish Radiation Safety Authority. In support of SSM's work, external expertise was also used in various disciplines. Table D-1 shows the experts engaged by SSM and their areas of expertise.

Reference	Discipline
Klos and Shaw 2009	Biosphere modelling
Geier 2009	Hydrology
Zhou et al. 2009	Comments on SAR-08 and modelling
Kozak 2009	Near-field modelling
Stenhouse et al. 2009	Comments on SAR-08
Klos 2009	Independent biosphere modelling.

During the review period, SSM participated in a research project concerned with modelling of carbon-14 (Limer et al. 2009).

On 27 August 2009, in accordance with the provisions of the Administrative Procedure Act, SSM sent the consultant reports that had been prepared to SKB, which thereby had an opportunity to offer viewpoints on the material (SSM 2009). In order to minimize the risk that SSM had misunderstood SKB's account, a preliminary edition of the review report was sent to SKB in September 2009. SKB submitted its comments on this on 21 October 2009.

## D2 Legal premises and other requirements

### D2.1 Background

In conjunction with the regulatory review of the updated safety analysis report submitted by SKB in 2001, an extensive survey was presented in Chapter 2 of (Dverstorp et al. 2003) of the legal premises for the repository. Parts of this survey still apply, but in some respects the set of requirements were clarified or tightened via e.g. updated operating conditions for SFR-1 and issuance of new regulations and general advice applicable to the final disposal of nuclear waste. A brief summary of the most important new conditions is provided below.

### D2.2 Operating conditions issued after review of FSR 2001

After the joint review of FSR 2001, the two authorities issued updated and supplemented operating conditions (SSI 2003, SKI 2003). The reason the conditions were updated was that the review identified the need for certain clarifications, for example with regard to the nuclide inventory, the closure plan, the monitoring programme and other methods for estimating the nuclide inventory in the waste. When SSI updated the radiation protection conditions in 2003, the conditions previously issued by the authority during the 1980s and '90s were superseded.

#### D2.2.1 Limits on the inventory in SFR

SSI stated that the inventory of radionuclides may not exceed the limits that served as a basis for the licence application, but pointed out that it should be possible, with the authority's approval, to make some reallocations of the radionuclide content in the different repository parts. A request for reallocation must include an assessment of how the change can be expected to affect the long-term environmental consequences. This condition was issued as a clarification of the restrictions that had already been adopted via the Government licence from 1983.

### **D2.2.2 Estimation of measurement and calculation methods for radionuclides in the waste**

The condition stipulates that the radionuclides that are most important for the safety assessment shall be determined with methods that are sufficiently accurate to ensure that applicable limits are met. The reason for the clarification of this condition was to be found in the conclusions from the review, which indicated that the methods used thus far underestimated the content of certain important radionuclides in the waste.

### **D2.2.3 Requirements on closure plan for final repository**

The condition stipulates that a plan for the measures that need to be adopted at closure must be prepared as a basis for ongoing operation. This condition was also clarified as a consequence of the review of FSR 2001. One conclusion from this review was that the lack of a detailed plan for final closure of the facility was a serious deficiency, since such a plan is needed as a basis for the safety assessment as well as for certain operational decisions that may need to be made.

### **D2.2.4 Requirement on periodic safety analysis report**

The condition stipulates that at least once every ten years, SKB must prepare and present an updated assessment of SFR 1 that describes radiation protection during operation as well as the repository's long-term protective capability and its environmental impact. In connection with each reporting occasion, SKB shall report important knowledge gaps and uncertainties of importance for long-term radiation protection as well as a programme for how to address these knowledge gaps and uncertainties.

## **D2.3 Radiation protection requirements and safety requirements**

In conjunction with the review of SKB's most recent safety assessment for a final repository for spent nuclear fuel, SR-Can, a survey was made of applicable requirements imposed by SSM's regulations and general advice. Since the formal requirements on a final repository for radioactive reactor waste are essentially equivalent to the requirements made on a final repository for spent nuclear fuel, reference is made to the survey in (Dverstorp and Strömberg et al. 2008). The most important difference concerns the requirement on how long a period the safety assessment needs to cover, as the requirement on the assessment for a final repository such as SFR 1 is 100,000 years after repository closure.

## **D3 Long-term function of SFR 1**

### **D3.1 Closure measures**

#### **D3.1.1 Background**

The regulatory review of FSR 2001 concluded that the fact that SKB had not prepared a detailed plan for final closure of the facility was a deficiency. SKB's plan was described only in "general terms" and therefore left questions unanswered, which, according to the regulatory authorities, made it difficult to assess the long-term function of the repository. As a consequence of the review, the authorities therefore place it as a condition (SSI 2003 and SKI 2003) that a plan for closure must be prepared and serve as a basis for the operational decisions that are made. An example that was offered was the need for closure measures for the repository part BLA, where contradictory information was provided by SKB in FSR 2001. Other examples given by the regulatory authorities concerned grouting of waste packages in the repository part BMA, where SKB provided unclear information. In addition, the authorities stated the need to analyse degraded plugs, where SKB dismissed this by saying that their design was not yet determined, see Section 3.3 in the review report (Dverstorp et al. 2003)

### **D3.1.2 SKB's account**

SKB describes in “general terms” planned closure measures for the different rock vaults (Section 5.5 in SAR-08). Certain measures are implemented during the operating period, such as grouting of waste packages in the silo. In the case of BTF, SKB plans to grout the waste packages just prior to closure. In the case of BLA, SKB says that backfilling will not be done, but that this may need to be reconsidered. In the case of BMA, the question of closure has not been finally decided. SKB is of the opinion that final planning of plugs in the repository is only possible when the total scope of SFR 1 is known.

### **D3.1.3 SSM's assessment of SKB's account in SAR-08**

Since the review of FSR 2001, SKB has only partially clarified the material, mainly by coming up with a preliminary plug design (Gunnarsson 2005). SSM observes that SKB has otherwise not updated the description of the plans in SAR-08 for closure of the facility, compared with the plans presented in FSR 2001. Hence, the questions concerning the need for backfilling of BLA and grouting of waste packages in BMA from the review of FSR 2001 still remain. Once again, SSM finds that the matter has not been addressed in a satisfactory manner and that the licence conditions for the facility are not satisfied. Particularly unsatisfactory are the ambiguities regarding the repository part BLA and the possible need to backfill it to prevent fracturing to the repository part BMA. SKB assumes in Section 5.5 that the repository part is left unfilled, but notes at the same time in Section 6.4.3 that measures to reduce the void volume in BLA for the purpose of reducing the loose zone should be considered in connection with repository closure. Furthermore, in the modelling of the groundwater flow done by SKB, it is assumed that the repository part BLA has been backfilled (Section 6.4.2). SSM is of the opinion that the fact that SKB has not provided more in-depth material and prepared a more detailed and concrete closure plan for SFR-1 in SAR-08 is a deficiency.

Furthermore, in view of the nature of the waste in BLA (mainly containers filled with trash and scrap metal), the question remains of whether backfilling of BLA solves the problems with the risk of fracturing between the repository parts, or whether the void volume in the waste is so great that a sufficient degree of filling cannot be achieved to prevent fracturing. This question need to be further elucidated.

### **Handling in SR-PSU**

A closure plan has been prepared to provide an integrated account of how the repository is planned to be closed (SKBdoc 1358612). The purpose of the closure plan is to provide a coherent description of the possible design and installation of closure components, taking into account design-basis assumptions and premises. The closure plan also describes grouting of the waste in the different waste vaults, which is a part of the preparations for future closure. Since closure with possible design and installation is based on present-day technology, it will be necessary to develop and evaluate the presented design for closure in the future. Technology development and further verification will be done before the final design of closure.

Technology development needed to establish the design of the extension has been identified in the closure plan. For a further description, see Section 4.2.8.

Handling of the two ambiguities that SSM has particularly noted in its assessment:

#### **Possible need for backfilling of BLA**

The need for backfilling in the waste vaults, especially BLA, has been studied (see the closure plan) and serves as a basis for the closure measures described in the closure plan. The study shows that BLA does not have to be backfilled.

#### **Grouting of waste packages in BMA**

According to the closure plan, the waste in both 1 and 2BMA will be embedded in grout (see also the **Initial state report**). The reasons for the need of grouting is presented in the closure plan.

## **D3.2 Nuclide inventory and waste**

### **D3.2.1 Waste in SFR**

Waste arising from operation of the Swedish nuclear power plants, as well as certain waste from Studsvik's facilities, is disposed of in SFR 1. The waste mainly consists of filters from the water cleanup systems (in the form of ion exchange resins) as well as of trash and other low-level waste that has arisen during operation. The content of gamma-emitting radionuclides in the waste is determined by measurements at the plants, where the waste is also treated and packaged. Certain radioactive waste deriving from hospitals, research and industry is also disposed of at SFR 1. This waste has been treated and packaged at Studsvik's facilities prior to transport to SFR 1.

### **D3.2.2 Methodology for derivation of inventory of cobalt-60, cesium-137 and plutonium-239 in SFR**

#### *SKB's account*

In report R-07-17 (Almkvist and Gordon 2007), SKB describes the methodology that is employed to derive the inventories on which the consequence analysis is based. SKB starts with the type descriptions that have or will be prepared for different types of waste from the different waste producers. The derivation is based on the following factors: 1) the number of waste packages of a given type description that were deposited on 31 December 2006, 2) a prediction of the annual future production of waste packages of each waste type, and 3) a reference content of radionuclides for each waste type.

For each type description, SKB has presented a reference content of different radionuclides. SKB has based these predictions on data and experience from waste already produced at the Swedish plants (mainly for the gamma emitters and the "key nuclides" cobalt-60 and cesium-137, as well as for the third "key nuclide" plutonium-239/240), and on the results of the investigations and analyses done of other important radionuclides such as carbon-14, nickel-59, technetium-99 and iodine-129.

Fundamental particulars for calculation of the inventory are obtained from the gamma spectrometry analyses that are done of the waste packages, by means of which the packages' content of the key nuclides cobalt-60 and cesium-137 is determined. In the case of the third key nuclide plutonium-239/240, SKB bases its determination on the measurements that are regularly performed of e.g. the reactor water at the nuclear power plants, by means of which the total quantity of plutonium-239/240 in the waste is determined. The following is then calculated based on these analyses:

- A reference content of cobalt-60 and cesium-137 for the different variants of each type description.
- A reference content of plutonium-239/240 that is assumed to be distributed between the different variants of the different type descriptions based on their reference content of cobalt-60 FD (at the fabrication date).

This information, along with information on the number of already deposited packages of each variant of the different type descriptions, is used to calculate the inventory at 31 December 2006. Calculation of the inventory in the waste that has not yet been deposited but is included in the three inventories that are calculated (see below) is based on an estimate of the annual production of waste.

The inventory of other nuclides than the key nuclides is calculated either by correlation with the key nuclides, or as a total quantity, or as a combination of these calculation methods. This is described in greater detail in the section *Method for determination of the inventory of other important radionuclides*. Three different inventories are calculated. One is based on the assumption that the nuclear power plants (with the exception of the Barsebäck reactors) are operated for 50 years and is calculated for the year 2040, and one is based on an operating time of 60 years and is calculated for 2050. As regards the reactors in Barsebäck, SKB assumes the actual operating time. No allowance has been made for a change in waste production due to power increases at the nuclear power plants or other changes that might affect this. In the case of waste from Studsvik's facilities, SKB assumes that this waste fills the quota which Studsvik has the contractual right to utilise. The inventory that is based on 50 years' operation of the nuclear power plants is used in the consequence analysis. Finally, an inventory is calculated for a "full" final repository where SKB fills up any remaining volume with a hypothetical waste so that the total activity content in the repository is  $10^{16}$  Bq in 2040. This inventory is used in the sensitivity analyses. SKB clarifies that they are aware that the calculated inventories may exceed the relevant inventory limits.

### *SSM's assessment of SKB's account in SAR-08*

SSM is of the opinion that SKB's methodology for calculating the inventory is basically appropriate, but finds the account to be incomplete, which makes it difficult for SSM to verify its application in detail. For example, SKB has chosen to report the reference content only for the most commonly occurring variant of each waste type, and not as a reference content for all waste packages belonging to the waste type. This means that the calculated inventories for the different waste types cannot be verified based on the reported material. Nor is it possible to make direct comparisons with SKB's previous account in R-01-03 (Riggare and Johansson 2001) for all types of waste.

Just like in the review of the 2001 report, SSM draws the conclusion that the content of the gamma-emitting key nuclides (cobalt-60 and cesium-137) is for the most part well-documented via the measurements that are made of produced waste. This also means that a satisfactory body of data is available for making predictions of future waste quantities. However, the review of inventory matters that followed after the review of the 2001 safety analysis report was concluded noted that problems have been encountered in picking out data on the gamma-emitting key nuclides from the database in a quality-assured manner (SSI 2006). It is difficult to draw any definite conclusions from the reported material as to whether this problem has been solved.

As is evident from the above, the amount of the key nuclide plutonium-239/240 that ends up in the waste each year is determined by analyses of the reactor water and the nuclides are allocated against cobalt-60 FD. SSM finds this methodology to be basically acceptable, but has objections to the fact that the "allocated" activity is not determined for e.g. each operating year. Instead, SKB applies the methodology on an ongoing basis, which means that the accumulated amount of cobalt-60 FD from each nuclear power plant is instead the determining factor. This leads to unreasonable consequences. An example is the deposition of packages containing ion exchange resins from reactor water cleanup, which are currently preferably deposited in the silo, and not as before also in BMA. The methodology entails that already deposited plutonium may be moved in the books from BTF and BMA to the silo, which can affect the calculated consequences in a non-conservative manner. SSM thus finds that SKB needs to improve the methodology for how plutonium is allocated between the repository parts. Because the waste's content of other transuranics is correlated to the quantity of plutonium-239, SKB's estimate of these radionuclides is also wrong.

SSM also notes certain other inaccuracies in the accounting of plutonium-239. In the case of e.g. reactor water cleanup waste from the Ringhals nuclear power plant, SSM's review has shown that the total quantity of plutonium-239 (for waste type R.16) has declined by a factor of 4 between the 2001 account and the present account, which is clearly unreasonable. In reality, the quantity of plutonium-239 ought to have increased, since 272 more packages have been manufactured during the period between the accounts. Based on the supplementary accounts submitted to SSM (SKB 2009), the concentration of plutonium-239 has also decreased by a factor of 2 in the waste deposited by Ringhals in BMA during the period in question. Since the activity level has declined in both BMA and the silo, the inaccuracy should not be caused by the methodology employed to allocate the activity. The discrepancies are probably due to inaccuracies in the accounts in SKB's reporting for 2001 (Riggare and Johansson 2001) and 2007 (Almkvist and Gordon 2007). SSM has not been able to determine exactly what these inaccuracies are.

### **Handling in SR-PSU**

#### **Reference content for different waste types**

In SR-PSU, all variants of a waste type have been included in the calculation of reference content for the different waste types. The method for describing reference content for the different waste types is reported in SKB (2013a).

#### **Data on gamma-emitting key nuclides**

The previously encountered problems with picking out data on the gamma-emitting key nuclides from the database in a quality-assured manner should no longer be an issue, since inventory data used in SR-PSU are stored in the new Triumf database.

#### **Inaccuracies in the accounting of plutonium-239**

In SR-PSU, plutonium-239 is allocated between the waste vaults in proportion to the allocation of cobalt-60 FD, as described in Section D3.2.3 below. This means that the problem noted by SSM for SAR-08 still remains.

### **D3.2.3 Methodology for determination of the inventory of other important radionuclides**

#### *Background*

Questions concerning the inventory of long-lived radionuclides in SFR have been the subject of extensive investigations and reviews since the regulatory authorities concluded their review of the safety analysis report for SFR 1, which was submitted in 2001. The reasons for the requested investigations originated from the doubts concerning compliance with two of the conditions stipulated in SSI's decision of 8 December 2003 on updated radiation protection conditions for SFR-1 (SSI 2003a). SSI requested that SKB submit an assessment of the actual inventory in the final repository as of 1 May 2006, as well as an account of the programme for measurement and calculation methods that are employed to determine the content of the most important radionuclides in the waste. The accounts submitted to the authority were reviewed as a basis for a decision dated 19 March 2008 (SSI 2008). The basis for most of the viewpoints set forth here can be found in this decision.

#### *SKB's account*

When it comes to long-lived radionuclides and radionuclides of importance for the safety assessment such as carbon-14, chlorine-36, nickel-59, nickel-63, molybdenum-93, technetium-99, iodine-129 and cesium-135, SKB relies primarily on information from the investigations that have been conducted over the years – e.g. Lundgren (2005), Lundgren (2006), Magnusson et al. (2007) and Persson (2005) – and that have been compiled in SKB (2008), and secondarily on the investigations conducted by Lindgren et al. (2007).

The following methodology has been employed. In the case of the aforementioned radionuclides (except for carbon-14, nickel-59 and nickel-63), an inventory for 2004 (or the year given by the relevant background report) has been calculated. When it comes to the waste that arises after this date, SKB uses the correlation factors determined by Lindgren et al. (2007).

Regarding the nickel isotopes, the inventory has been calculated with correlation factors and the standard package's content of cobalt-60. In the case of carbon-14, the inventory has been estimated based on the total amount for 40 years of reactor operation calculated in Magnusson et al. (2007). The calculated activity has been allocated between the repository parts in proportion to the allocation of cobalt-60 FD.

#### *SSM's assessment*

##### *Carbon-14*

An important conclusion from the regulatory review of the safety analysis report which SKB submitted in 2001 was that the methodology used was not acceptable and probably underestimated the inventory of carbon-14 in the operational waste. As a consequence of the regulatory authorities' decision, the methodology has been revised and SKB no longer assumes a correlation between the content of cobalt-60 and carbon-14 in the waste. Instead, SKB bases its estimate on actual measurements of carbon-14 in different types of waste from the nuclear power plants, and based on these results a total quantity of carbon-14 from 40 years of operation and an annual increment for additional operating years have been calculated.

SSM judges that the studies that have been done are of good quality and that the specified inventory of carbon-14 is a better estimate than previously. The studies confirm the conclusions previously drawn by the regulatory authorities that primary cleanup resins from the pressurized water reactors (PWRs) at Ringhals (units 2–4) are an important source of carbon-14 in the operational waste. The studies show that waste from boiling water reactors (BWRs) can also be an important source of carbon-14, albeit less so than the waste from PWRs. For BWRs it is instead the condensate filter demineraliser that can contain the largest quantities of carbon-14. In the studies performed to date, condensate filter demineraliser from Forsmark 1 and 2 has been identified as an important source of carbon-14. Even though the methodology is an improvement as compared to previous assessments, SSM judges that the measurement programme conducted so far is not sufficient to enable definite conclusions to be drawn regarding the total carbon-14 content of the waste and its allocation between different repository parts in SFR-1. In order to perform a better estimate, results would probably be needed from the measurement programme decided on by SSI on 19 March 2008 (SSI 2008).

The methodology for allocating the activity between the different repository parts also needs to be revised for future reports, since carbon-14 is probably not allocated like cobalt-60 in the waste. The method employed in SAR-08 has probably led to an underestimation of the inventory of carbon-14 in BMA, while the inventory in the silo may be overestimated.

Previously done reviews have also revealed uncertainties regarding the content of carbon-14 in the waste that is disposed of at the facilities in Studsvik's plant, mainly waste received from external suppliers. SKB states in (SKB 2008 and Almkvist and Gordon 2007) that waste disposed of thus far from Studsvik contains a total of between 0.1 and 1 GBq of carbon-14. Previous studies from Studsvik (Studsvik 1985 and SSI 1988) state that the quantity of carbon-14 delivered annually from Studsvik to SFR-1 is on the order of 10 GBq. Depending on how it is managed at Studsvik, all or parts of this activity may have been transferred to SFR (mainly the repository parts BLA and BTF). As a result of these discrepancies and ambiguities concerning the management of waste from external suppliers, SSI (2008) stopped further deposition of parts of the waste from Studsvik.

#### *Nickel-63 and nickel-59*

It is stated in (SSI 2008) that the estimated inventory of nickel-59 and nickel-63 in SFR is determined to a high degree by the correlation factors that apply for waste from PWRs and by the distribution of cobalt-60 in the waste from Ringhals, where waste from BWRs and PWRs is mixed. The inventory is roughly proportional to the correlation factor for PWRs and the fraction of cobalt-60 from PWRs. The correlation factors are judged to be conservatively chosen, while the argumentation in support of a 35% cobalt-60 fraction from PWRs needs to be better substantiated. SSI also concludes that some waste from BWRs can also be of importance and therefore decided to require supplementary measurements.

In the review by Almkvist and Gordon (2007), SSM found some ambiguities in the account of the nickel isotopes. For waste from Ringhals, SKB has only given the correlation factors that apply to waste from BWRs. For waste from Clab (type description C.24), the correlation factors that applied in 2001 have been given. At a meeting on 26 March 2009 (SSM 2009), SKB explained that the incorrect values for the waste from Ringhals are due to the fact that only one correlation factor can be given in the database, but factors for both PWRs and BWRs have been used in the calculations. The error for the waste from Clab is due to the fact that this figure has not been updated since 2001, since no new packages have been manufactured. Pending further studies, SSM accepts the current estimate.

#### *Chlorine-36, technetium-99, iodine-129 and cesium-137*

The inventory for these radionuclides has been determined on the basis of the total quantity of waste up to and including 2004. The activity in the repository is allocated against cobalt-60 FD, except for cesium-135, which is allocated against cesium-137 FD. In the case of waste produced after this date, the correlation factors that are derived in Lindgren et al. (2007) have been applied.

This was also reviewed by SSI, and in its decision of 19 March 2008 the authority found that the estimate is reasonably reliable based on the available measurement data. In its decision, the authority pointed out the necessity of carrying out regularly updated analyses for these nuclides, using the methodology on which the authority's decision was based. Pending further results, SSM deems that the inventory on which SFR SAR-08 is based constitutes a reasonable estimate.

### **Handling in SR-PSU**

**Methodology for derivation of inventory of cobalt-60, cesium-137 and plutonium-239 in SFR 1**  
SSM judged that the accounting of inventory in Almkvist and Gordon (2007) was incomplete since the reference content is only presented for the most common variant of each type of waste and not for all waste packages belonging to the waste type description. In SKB (2013a), the reference content was reported as an average for all waste packages belonging to the waste type. Reference content is estimated and presented for the time of closure of the repository, i.e. 2075. This change makes it difficult to make direct comparisons between the previous accounting in Almkvist and Gordon (2007) and that in SKB (2013a).

SSM believes that the methodology used for the allocation of the key nuclide plutonium-239/240 is in principle acceptable, but has objections to the distribution of activity since it is not fixed for each year of operation. SSM expresses concern that the activity should be distributed in a non-conservative way between different parts of the repository. The methodology for allocation of key nuclides has not been changed. During operation of the repository, the accounted amount of plutonium for each waste vault may therefore become “too large” because all produced plutonium is recorded as deposited in SFR, while much is actually stored at the nuclear power plants in already-produced packages or in tanks with ion-exchange resins. Adding the stored plutonium content of each year is administratively difficult to implement because SKB then have to find a method to allocate the produced plutonium on actual and future packages. SKB considers that this is difficult because stored ion exchange resins from many years of production could be mixed before the waste packages would be produced. SKB considers that such annual fixed plutonium content does not necessarily lead to a better description of the actual conditions at the time of closure.

Since april 2014, new acceptance criteria for SFR have been implemented. The new criteria regulate the content of i.e. gas-forming materials and organic complexing agents. For example in 2BMA, cellulose is not allowed in such quantities that the sorption of the most sensitive radionuclides are affected.

#### **Methodology for determination of the inventory of other important radionuclides**

C-14:

SSM is of the opinion that the investigations carried out are of good quality and that the specified inventory of C-14 gives a better estimate than previously. However, SSM has objections of the method by which SKB distributes C-14 in relation to the amount of cobalt-60-FD in the waste. The sampling program for the measurement of C-14 is progressing. Furthermore, SKB has adjusted the method of allocation of C-14; the allocation is now based upon the amount of ion exchange resin containing C-14 for each waste vault, instead of the previous allocation in relation to Co-60 (FD). This gives a more accurate distribution of C-14 between the different waste vaults, and do not overestimate the C-14 content in the silo compared with that in 1BMA. As for the amount of C-14 in waste from Studsvik Nuclear AB and AB SVAFO, no change in methodology has been implemented. Attempts have been made to get better data from these providers. SKB's standpoint is that such waste should be stored in SFR only if further investigations can show, in an acceptable manner, that the waste contains acceptable amounts of C-14 activity.

Ni-59:

SSM found that the correlation factors used to determine the amount of nickel needed to be better justified. Nickel-59 in the waste from nuclear power plants is now calculated from the measured values of nickel-63. For the already deposited waste, the correlation factors used in Almkvist and Gordon (2007) are still applied, including the distribution between BWR and PWR of cobalt-60 in the waste from the Ringhals.

Cl-36, Tc-99, I-129 and Cs-135:

SSM is of the opinion that the estimations of these nuclides are reasonably accurate, based on the data available. SSM points out the need to periodically conduct updated analyses. SKB has for these nuclides, since Almkvist and Gordon (2007) made annual estimates based on nuclide specific models.

### **D3.2.4 Connection between operation and long-term radiation protection and safety**

#### *Background*

In their review of FSR 2001, the regulatory authorities found that SKB should have described how they ensure that the operation-related measures that are adopted are optimised with respect to the long-term function of the final repository as it is described in the safety analysis report. This applied to definition of waste types, direction of waste packages to different repository parts, deposition procedure and successive closure. The regulatory authorities also said that SKB should reconsider the allocation of waste packages between the different repository parts, especially considering that the most advanced repository part (the silo) was only predicted to be just over half-full at the expected closure of the facility.



As a consequence of the joint regulatory review, SSI requested in a decision dated 8 December 2003 (SSI 2003b) that SKB should explain how SKB and the waste producers guarantee compliance with the requirements on optimisation of radiation protection and use of the best available technology (BAT) in the operation of SFR-1. SKB submitted the requested accounts on 31 January 2008 (SKB 2008). In these accounts, SSI found that SKB had acceptably clarified the criteria for how waste is directed to the different repository parts. SKB pointed out that a total optimisation of repository operation is planned to be done when an application for an extension is submitted in 2013. SKB said that the documentation of the interaction between operation and long-term radiation protection needed to be better documented in the future, which SSI deemed to be necessary.

#### *SKB's account*

In SAR-08, SKB gives only a rough account of the principles that are applied in directing the waste to the different repository parts in SFR-1:

- The intermediate-level waste – consisting mainly of spent ion exchange resins, filter resins and filter cartridges from reactor and pool water cleanup circuits – is deposited together with certain waste from Studsvik in the silo.
- Intermediate-level waste with chemical or mechanical properties that are undesirable for the silo is deposited in BMA, along with other waste which does not need to be deposited in the silo, but which cannot be placed in BLA due to radiation shielding. The waste consists of the most part of ion exchange resins from condensate polishing circuits and cement-solidified trash and scrap metal.
- Intermediate-level dewatered powdered ion exchange resins and waste drums from the incineration of low-level trash in Studsvik are deposited in the 1BTF and 2BTF rock vaults.
- Waste with a very low activity content is deposited in BLA.

SKB says that these allocation principles have been applied since the start of operation of the facility and are intended to be applied in the future. At the same time, SKB says that it can in certain cases be optimal from an ALARA viewpoint to deposit waste in a repository part that was not originally planned for this waste, and that a reasonableness assessment has to be made in such cases. Finally, SKB says that if the requirements for deposition in the planned repository part are not fulfilled due to mishaps or faults in production, the need for measures is determined from case to case.

In conjunction with a future extension, SKB states that the intention is that the repository as a whole will be relicensed to permit deposition of both operational and decommissioning waste in the repository as a whole.

#### *SSM's assessment of SKB's account in SAR-08*

With regard to the direction of waste to the different repository parts, SSM does not share SKB's view that the fundamental principles have so far been strictly followed. There are a number of reasons for this, which were noted in the review of FSR 2001 (Dverstorp et al. 2003). An important example is that waste packages containing resins from cleanup of reactor water and fuel pools have largely been deposited in BMA instead of in the silo. In SSM's judgement, the current activity distribution between BMA and the silo is largely attributable to these packages, with a higher proportion of long-lived activity in BMA that was originally intended.

For the further operation of the facility, however, SSM believes that a stricter direction of the waste should be possible in accordance with the original intentions for the facility. However, SSM judges that this is not made clearly evident in SAR-08, but instead in the reports previously submitted by SKB to SSI (SKB 2008). This document explains the sorting procedures which SKB and the waste producers currently apply in an acceptable manner. In view of the fact that this document was adopted after SAR-08 was published, SSM accepts the account of this matter in SAR-08, but notes that SFR SAR needs to be updated in this respect in the future.

With regard to the review SKB conducts of the type descriptions prepared by the waste producers, the regulatory authorities have previously noted deficiencies in both the documentation of the review and the review itself. Sufficient consideration has not been given to the application of BAT, and the authorities have, for example, rejected applications for deposition of waste packages that could have caused unnecessary degradation of the repository barriers in the long-term. SSM observes that SKB does not go into any depth in SAR-08 on how new waste types are assessed other than to say that “impact on repository and environment is assessed against the safety assessments that have been performed” and that “The acceptance criteria for the particular repository part must be fulfilled.” SSM intends to pursue this matter further in, for example, improved regulations and future reviews of new waste types.

## Handling in SR-PSU

### Connection between operation and long-term radiation protection and safety

The radionuclide transport calculations are based on an assumption of a future deposition strategy, described in the **Initial state report**. Furthermore, preliminary waste acceptance criteria have been established and a new method for developing waste type descriptions is currently under establishment. The new waste acceptance criteria and waste type descriptions should facilitate the upcoming work in this field.

## D3.3 Methodology for safety assessment

### D3.3.1 SKB’s account

According to SKB, the safety assessment for SFR-1 is based on the 9-step methodology presented in the preliminary safety assessment of the final repository for spent nuclear fuel, SR-Can (SKB 2006).

An initial step in the methodology is the identification of factors that are important for the evolution of the repository. SKB has performed this survey in two steps, the first of which was done prior to the publication of FSR 2001 and covers the period up to 10,000 years after closure. In the second step, SKB supplemented the assessment for the period up to 100,000 years after closure. In the next step, the initial state of the repository, the rock and the biosphere is described at closure in 2040. The system’s safety functions are identified and described. The purpose of these safety functions is to describe the system’s function as a basis for the determination of a number of indicators against which the repository and the surrounding system can be evaluated. This analysis serves as a basis for the selection of scenarios and calculation cases. Based on the identification of important features, events and processes, a reference description is prepared, along with a number of other more or less probable scenarios. The calculation cases that are analyzed are then formulated on the basis of these scenarios. The results are evaluated against the risk criterion and serve as a basis for a summary safety evaluation.

### D3.3.2 SSM’s assessment of SKB’s account in SAR-08

The new safety assessment methodology for SAR-08, which greatly resembles that developed by SKB in SR-Can, is based on well-defined steps such as: FEP handling, initial state, safety functions, reference evolution, selection of scenarios, selection of calculation cases, dose and radionuclide transport calculations, weighing together of risk, and safety evaluation. SSM finds this methodology to be clear and expedient and believes that it offers good potential for conveying a clear picture of which features, events and processes that affect the repository’s long-term radiation safety. The use of graphical aids in SAR-08 such as interaction matrices and information flow diagrams contributes to the clarity of the presentation.

One area that can be improved is, however, the account of how identified features, events and processes have been taken into account in the development of the conceptual calculation models. One such example concerns the biosphere models that have been constructed. SSM is of the opinion that SKB needs to carry out this step in the applied methodology in a more detailed fashion in future analyses, see also (Klos and Shaw 2009).

SKB bases SAR-08 on safety functions similar to those used in SR-Can. SSM believes that this is a suitable methodology, since it creates clarity regarding performance requirements for different components and makes it easier to focus the assessment on safety-critical matters.

An important change in the safety assessment compared with FSR 2001 is extension of the time scale to 100,000 years. This extension entails that analyses more than well cover external changes that can affect the repository's safety functions. It is also appropriate in view of the time scale for the decay of the most important radionuclides in the waste.

Special calculation cases such as intrusion wells and the consequences of an unclosed repository are handled in accordance with the regulations.

Well-structured background reports have been developed in SR 97 and SR-Can (model summary report etc.). It is good that SKB has at least in part developed an equivalent report structure for SFR.

On the whole, the calculation cases provide a good picture of the events and processes that can affect the long-term radiation safety of the repository. In some cases, however, the calculations are not optimally structured to shed light on the safety-related importance of remaining uncertainties. An example is the calculation cases that are supposed to illustrate the importance of degraded barriers (early degradation of barriers and extreme permafrost).

### **Handling in SR-PSU**

An analysis of features, events and processes that can be of importance for the development of surface systems, for the transport and accumulation of radionuclides, and for exposure of humans and non-human biota, is described in SKB (2013c). The handling of these processes in the SR-PSU assessment is described in SKB (2014b).

## **D3.4 Climate evolution**

### **D3.4.1 Background**

The question of how a future climate will affect the function of the final repository was one of the questions highlighted by the regulatory authorities after the review of FSR 2001 (Dverstorp et al. 2003). In FSR 2001, SKB stated that permafrost cannot be ruled out within a 5,000-year period, but that the probability of this should be low. The importance of permafrost was evaluated by assuming that the entire final repository system was frozen up until 10,000 years after closure. SKB assumed that releases after that take place to a receptor that corresponds to today's biosphere conditions in the area, i.e. the Baltic Sea. This was criticized by the regulatory authorities, who said that SKB should have offered evidence for what are the conditions that could be expected to prevail in conjunction with permafrost and instead evaluated the dose consequences for these receptor rather than assuming today's conditions.

### **D3.4.2 SKB's account**

In SAR 08, the climate scenarios are crucial for assessing the long-term function of the repository. In the case of both BMA and the silo, SKB believes that the climate will be the crucial factor in determining how long the engineered barriers will remain intact. In the case of BMA, this is determined by when the barriers freeze and collapse due to permafrost. In the case of the silo, the life of the barriers will ultimately be determined by the time of the first extensive icing of the repository, due to the fact that the bentonite clay risks being eroded by meltwater.

SKB's account of possible climate evolutions is based on the work done in preparation for the account in SR-Can. SKB identifies three relevant climate domains for the site and the analysis period in question:

- Temperate climate domain.
- Permafrost climate domain.
- Glacial climate domain.

Based on reconstructed conditions for the last glacial cycle, a reference evolution for the climate has been arrived at with the aid of simulations of the movement of the ice sheet and permafrost growth. Since the calculations are based on the analyses done for SR-Can, the calculations of permafrost depth are based on the thermal properties of the rock on the intended site of the final repository.

However, SKB has conducted (Vidstrand et al. 2007) a sensitivity analysis of the importance of the thermal diffusivity of the rock and the geothermal flux.

According to SKB's calculations, permafrost will reach repository depth about 10,000 years after closure. More extensive permafrost for the postulated climate evolution occurs after an additional 10,000 and 35,000 years, respectively. At the latter time, the temperature at repository depth is expected to reach about  $-5^{\circ}\text{C}$ .

SKB also presents a climate evolution that takes into account the increasing influence of the greenhouse effect on the climate. In this case, a temperate climate domain is assumed to prevail for 50,000 years after closure, followed by the initially mild period of climate evolution based on a reconstruction of the Weichselian. In this climate evolution, the first permafrost occurs at repository depth about 60,000 years in the future.

The background report by Vidstrand et al. (2007) also includes a climate evolution with a dry climate, favourable for permafrost formation, based on the Weichselian evolution. In these conditions, an ice sheet will not be established, which means that the permafrost will reach greater depth after 50,000 years. Another important difference is that the earlier periods of permafrost will be more pronounced. For example, at 10,000 years after closure the temperature at repository depth is expected to be about  $2^{\circ}\text{C}$  lower than for the reference evolution.

### **D3.4.3 SSM's assessment of SKB's account in SAR-08**

In the review of the climate report which SKB prepared for SR-Can, on which the climate analysis for SAR 08 is based, the regulatory authorities noted that SKB is essentially on solid ground in its understanding of most aspects of future climate change. In this review as well, SSM can now conclude that SKB's analysis of the importance of future climate change has been better integrated in the safety assessment than was the case in FSR 2001<sup>18</sup>. SKB's approach also follows the structure of the safety assessment that is recommended in SSMFS 2008:37, namely that the assessment should be based on a number of defined climate sequences that are dealt with separately in the risk analysis.

Regarding the assessment of the thermal evolution in SFR-1 as a consequence of a colder climate, SSM finds that SKB should have taken into account possible differences between the thermal properties in the rock at SFR and the properties of the rock on the site for a possible final repository for spent nuclear fuel.

As is evident from the general advice for on the application of SSMFS 2008:37, the climate evolutions that are selected for the risk analysis "should be selected so that they together illustrate the most important and reasonably foreseeable sequences of future climate states and their impact on the protective capability of the repository and their environmental consequences." SSM deems that the alternative climate scenario "Extreme permafrost" is a reasonable starting point for evaluating how an alternative climate evolution could affect the evolution of the repository.

The most important deficiency in SKB's account concerns the connection between the climate evolution and the long-term function of the barriers. As observed in Section D3.8, the margins to damage to the cement barriers already at temperatures just below  $0^{\circ}\text{C}$  are insufficiently investigated. SSM is of the opinion that SKB should undertake a more rigorous technical evaluation of what thermal conditions could damage the repository's barriers, and on the basis of such an analysis undertake a more in-depth evaluation of the importance of the permafrost periods which, according to Vidstrand et al. (2007), may occur already during the first 10,000-year period. SSM deems that there is a need for more in-depth efforts in this area in order to strengthen confidence in the risk evaluation.

---

<sup>18</sup> SSM would, however, like to point out that the manner in which SKB has modelled the greenhouse scenario cannot be considered to be sufficiently well-justified. A change in climatic conditions due to an increased greenhouse effect cannot be expected to postpone a climate evolution driven by astronomical factors (represented by a repeat of the Weichselian), but rather be superimposed on it. This means that if the period with greenhouse effect lasts 50,000 years, a period with a decidedly colder climate – determined largely by astronomical factors – will occur just after 50,000 years in a greenhouse case as well, and not after about 100,000 years as SKB assumes. However, this error does not affect the consequence analysis in SAR-08, since the greenhouse scenario is not bounding for the risk analysis.

## Handling SR-PSU

The strategy and the methodology for analysing future climate and climate-related processes in the SR-PSU safety assessment is described in brief below. This description is taken from Section 3.5.1. After that, the response to SSM's comments on SAR-08 is described.

The overall strategy for handling climate and climate-related processes in safety assessments is to define a number of possible future climate evolutions (climate cases) that cover the uncertainty in the future climate evolution. However, due to differences in the nature of the waste (radioactivity level and half lives), which determines the time period to be covered by the safety assessment, as well as differences in repository concept (barrier material and repository depth), the span represented by the climate cases differs between different safety assessments (see further Näslund et al. 2013). The radioactivity of the waste in SFR declines to low levels within the first ten thousand years or so after closure, warranting a total assessment period of about 100,000 years. This can be compared with the safety assessment for a repository for spent nuclear fuel (SR-Site), where the assessment period is a million years. The shorter assessment period for SFR, plus a shallower repository depth (about 60–140 m for SFR compared with 450–470 m for the Spent Fuel Repository), requires a greater focus on the evolution of the climate during the next few tens of thousands of years. The earliest possible onset of shallow permafrost growth and freezing of the barrier structures in SFR is then of great importance. This question was not relevant in the SR-Site safety assessment. What was instead relevant was the question of whether freezing in conjunction with permafrost can reach repository depth during the assessment period of a million years (SKB 2011).

In earlier safety assessments for low- and intermediate-level waste (SAR-08) and for spent nuclear fuel (SR-Can, SR-Site), a reconstruction of the last glacial cycle was used, along with a span of other climate cases, to assess the long-term safety of the repository. In the present safety assessment, the methodology for assessing safety for SFR has been refined. Given the shallow repository depth and the properties of the barriers, the assessment has focused on determining the time of onset of the first period with permafrost in the Forsmark area. Present-day knowledge of relevance to this question has therefore been given more weight in the definition of the climate cases analysed in SR-PSU. The current state of knowledge suggests that due to human activities, in combination with small variations in future insolation, the evolution of the global climate during the coming hundred thousand years will not resemble the last glacial cycle (**Climate report**). The climate case based on a reconstruction of the last glacial cycle is therefore given less focus in the SR-PSU safety assessment. In summary, the difference between the strategy for defining climate cases of relevance to the safety assessment between the current SR-PSU and the previous safety assessment for the Spent Fuel Repository (SR-Site) is primarily warranted by the fact that:

- The time period for the safety assessment is 100,000 years for low- and intermediate-level waste, to be compared with 1 million years for spent nuclear fuel. This means that the present safety assessment is handling a *specific* hundred-thousand-year period, during which the effects of human activities are expected to be relevant. By contrast, safety assessments for spent nuclear fuel repositories handle a *typical* hundred-thousand-year period representing natural climate variations recorded in geological archives during the past 700,000 years.
- Our scientific understanding of the effects of human activities on the long-term climate evolution has improved during the past few decades. The coming 100,000 years are expected to be characterised by a prolonged interglacial lasting 50,000 – or even 100,000 – years due to the high concentrations of carbon dioxide in the atmosphere, in combination with small variations in insolation.

### **Thermal properties of the rock at SFR compared to the suggested site for the final repository for spent nuclear fuel**

After SAR-08, site-specific simulations of the thermal evolution of the rock, including formation of permafrost and frozen rock, have been carried out within the framework of SR-Site (Hartikainen et al. 2010). These simulations were done along a 15 km profile that intersects both the Spent Fuel Repository and SFR. In most cases where results from SR-Site are used in SR-PSU, data from the site of SFR are utilised. In the case where dedicated permafrost simulations were done for SR-PSU (Brandefelt et al. 2013), data from the SFR site were analysed, i.e. the thermal properties of the rock at SFR have been included in all of these new simulations.

Furthermore, systematic sensitivity analyses of how different parameters affect the temperature in the bedrock clearly show that it is mainly the conditions at the ground surface – such as air temperature, amount of precipitation during the winter, type of vegetation and soil moisture – that are crucial in this respect (Hartikainen et al. 2010). Factors in the geosphere, such as the thermal properties of the rock and the chemical composition of the water, are only of secondary importance for the temperature evolution of the rock (including growth of permafrost and frozen rock).

### **Connection between climate evolution and long-term barrier function**

Since the time of the first potential period with permafrost in Forsmark is of great importance for the long-term safety of SFR, this question has been investigated in a study that is presented in a background report (Brandefelt et al. 2013). The study aimed at analysing the possibility of permafrost in Forsmark during the next 60,000 years considering known variations in insolation and a range of possible atmospheric carbon dioxide concentrations. There was a special focus on the question of whether the climate in Forsmark could become sufficiently cold to result in permafrost during periods of low insolation, which will occur in around 17,000 and 54,000 years. The future climate was simulated for these periods using a simplified climate model, LOVECLIM (Driesschaert et al. 2007) and a state-of-the-art climate model, CCSM4 (Gent et al. 2011).

In order to provide input data for the analysis of the possibility of permafrost in Forsmark, both equilibrium simulations (where forcing conditions such as atmospheric greenhouse gas concentrations and insolation were held constant) and transient simulations (where the spatial and seasonal distribution of insolation varied in time as expected based on future variations in the astronomic parameters) were done. The equilibrium simulations were carried out for the periods 17,000 years and 54,000 years after present and with atmospheric carbon dioxide concentrations in the range 180 to 440 ppmv (parts per million, volume). The simulated air temperature in Forsmark that gave the coldest climate was then used as input to the same permafrost model as was used for SR-Site (Hartikainen et al. 2010, SKB 2010c). Based on the sensitivity studies that were done in Hartikainen et al. (2010), a dry climate and a dry ground surface above SFR were here assumed in the permafrost simulations, since these conditions are most favourable for permafrost growth. Furthermore, a number of new sensitivity experiments were done with the permafrost model where the air temperature was reduced compared to the temperature simulated with the climate model. The results of the climate simulations show, as expected, that the climate may be colder during the future periods around 17,000 and 54,000 years after present. The conclusions of the study were based on a comparison of the results in question with other studies of future climate where an evaluation of the uncertainties in the results was of central importance. All uncertainties in the simulated climate were assumed to influence the results towards a maximally cold climate.

When the uncertainties in methodology and in the current state of knowledge concerning future climate evolution are included, the conclusion of the study is that permafrost could form in the area around SFR in both 17,000 and 54,000 years, provided that the atmospheric carbon dioxide concentration has declined to relatively low levels (**Climate report**). However, this does not automatically mean that the repository structures in SFR will freeze, since for example concrete has a lower freezing temperature than water. This has been studied by freezing of concrete specimens (Thorsell 2013). Based on these results, the freezing criterion has been set at  $-3^{\circ}\text{C}$  (Section 6.5.8). In the SR-PSU safety assessment, this information, together with the results of the climate and permafrost simulations, has been used to analyse when freezing of the concrete structures in SFR could occur at the earliest.

### **Justification of the global warming climate case**

It is highly likely that the current interglacial (Holocene) will be significantly longer than the previous interglacial as a result of human emissions of carbon dioxide to the atmosphere, along with future variations in insolation (e.g. Berger and Loutre 2002). During previous interglacials – such as the Eemian, which started about 130,000 years ago – the carbon dioxide concentration in the atmosphere reached a peak of about 300 ppmv, after which it declined. This stands in stark contrast to the present-day situation, where the carbon dioxide concentration has increased from about 280 ppmv to nearly 400 ppmv in 160 years and is expected to increase further to a peak determined by human activities (e.g. Solomon et al. 2011, IPCC 2013). The carbon dioxide concentration is then expected to decline very slowly due to the processes that remove carbon dioxide from the atmosphere. Based on the current state of knowledge, Archer et al. (2009), for example, draw the conclusion that the

effects of carbon dioxide emissions on the Earth's climate will be apparent for tens of thousands, or even hundreds of thousands, of years in the future. Based on the current state of knowledge, a trend towards a colder climate – similar to the trend that occurred towards the end of the last interglacial, the Eemian, about 115,000 years ago – is not deemed realistic for the coming 10,000 years, and possibly not for the coming 100,000 years either.

In order to cover the uncertainty in the future climate evolution during the coming 100,000 years, four different climate cases have been defined in SR-PSU. They have been defined on the basis of current scientific knowledge concerning the future evolution of the climate and climate-related processes. Each climate case represents a future evolution of the climate and climate-related processes in Forsmark. The purpose of the climate cases is that they should serve as a basis for an analysis of climate-related processes that could have an impact on the repository's safety functions.

The four climate cases are described in Chapter 4 of the **Climate report**. The first three climate cases have been defined to represent the uncertainty in the future climate evolution that is dependent on the uncertainty in the magnitude and duration of human impact on the climate system. These three cases therefore represent low, medium and high anthropogenic emissions of greenhouse gases, where these are defined on the basis of the IPCC's definition of low, medium and high emissions (IPCC 2007). The three cases are:

- *Early periglacial climate case*, which represents low anthropogenic emissions of greenhouse gases and a relatively rapid decrease in the atmospheric carbon dioxide concentration.
- *Global warming climate case*, which represents medium anthropogenic emissions of greenhouse gases.
- *Extended global warming climate case*, which represents high anthropogenic emissions of greenhouse gases.

The length of the initial period with high anthropogenic impact on the climate evolution, which was questioned by SSM in the review of SAR-08 (Section D3.4.3 above), has been defined on the basis of an updated survey of the current state of knowledge, see Section 3.3.5 in the **Climate report**. The uncertainty in the length of this period is represented by these three climate cases.

*The global warming climate case* has been defined to reflect the results of a number of modelling studies, which are described in Section 3.3.5 in the **Climate report**. The conclusion of these studies is that if the atmospheric carbon dioxide concentration has declined to a pre-industrial level of about 280 ppmv, inland ice sheets can begin to grow in the northern hemisphere in about 50,000 years.

*The early periglacial climate case* represents the lower end of the uncertainty interval around future anthropogenic greenhouse gas emissions, the global carbon cycle, and the climate system's response to the emissions. It is defined as a variant of the *global warming climate case* with a more rapid decline in the atmospheric carbon dioxide concentration, resulting in a cold climate in Forsmark during a period around the next insolation minimum in about 17,000 years. Based on the study of the potential for a cold climate and permafrost in Forsmark over the next 60,000 years (Brandefelt et al. 2013) mentioned above, the air temperature in Forsmark is assumed to be low enough during this period for permafrost to form.

*The extended global warming climate case* represents the upper end of the uncertainty interval around future anthropogenic greenhouse gas emissions, the global carbon cycle, and the climate system's response to the emissions. This climate case has been defined to reflect the results of the modelling studies described in Section 3.3.5 in the **Climate report**. The conclusion of these studies is that if the atmospheric carbon dioxide concentration continues to be much higher than the pre-industrial level of about 280 ppmv, the growth of ice sheets in the northern hemisphere will not be able to start until after about 100,000 years.

The fourth climate case is the *Weichselian glacial cycle climate case*, which represents a repetition of conditions reconstructed for the last glacial cycle (i.e. the Weichselian and the Holocene). This case is included to represent the uncertainty regarding the timing and the rate of ice sheet build-up in the Northern Hemisphere. The reconstruction of the last glacial cycle is also used to represent natural climate variability after the period with high anthropogenic impact on the climate evolution in the *global warming climate case* and the *early periglacial climate case*. This climate case is only slightly adjusted compared to the reference evolution in SAR-08 and the *Reference glacial cycle* in the safety assessment for the Spent Fuel Repository, SR-Site.

### **D3.5 Selection of scenarios and scenario probabilities**

#### **D3.5.1 SKB's account**

The terms "safety indicators" and "safety performance indicators" were introduced in the SR-Can safety assessment. The methodology of deriving scenarios from an analysis of these indicators for the post-closure period has been employed in SAR-08.

SKB says that the fundamental safety functions of the final repository are to limit and retard releases, and that these safety functions differ between different parts of the repository. SKB further states that the limited inventory of radionuclides is a prerequisite for safe function. The following safety functions are identified:

- BLA: Limited waste quantity.
- BTF: Limited waste quantity and hydraulic and chemical function of concrete tanks.
- BMA: Limited waste quantity, hydraulic and chemical function of concrete structures.
- Silo: Limited waste quantity, hydraulic function of silo wall of bentonite and chemical function of concrete structures.

An additional safety function is the repository's location with respect to the shoreline, since no drinking water wells are expected to be drilled while the repository is located beneath Baltic Sea. For each and every one of the safety functions, one or more safety performance indicators are identified, as shown in Table 5-3 in SAR-08. These serve as a basis for SKB's selection of scenarios for the safety assessment.

The scenarios include a main scenario based on a reference evolution of the repository and a number of supplementary scenarios. The main scenario is based on a specific initial state and two variants of the climate evolution (a repetition of Weichselian and a greenhouse variant). It is assumed in the two calculation cases that closure plan, inventory and performance follow the best estimate. The barriers for BMA and the silo are assumed to be intact 42,000 and 66,000 years after closure, respectively.

The supplementary scenarios are divided into two groups: seven less probable scenarios and five residual scenarios. The less probable scenarios include calculation cases such as impact of earthquakes, early freezing of the repository, talik (discontinuous permafrost), high concentrations of complexing agents, increased gas formation in the silo, and a well in the discharge area. The residual scenarios include calculation cases of e.g. alternative inventory, no sorption in the near-field and early degradation of engineered barriers. SKB gives the estimated probabilities for the main scenarios and the less probable scenarios in Table 7-18. No probability is given for the residual scenarios.

#### **D3.5.2 SSM's assessment of SKB's account in SAR-08**

SSM finds that SKB's method for deriving scenarios for the safety assessment has been improved compared with FSR 2001. The method entails a structured attempt to identify the critical issues for the long-term function of the repository. SSM also finds that the method meets the Authority's prescribed requirements on a general level, partly by virtue of the division between main scenario, less probable scenarios and residual scenarios, and partly by analysing alternative climate sequences separately, each with a probability of one.

SKB bases its line of reasoning regarding the probability that a well will be drilled in the discharge area on the expected well frequency in the area around Forsmark and the size of the discharge area. SKB estimates that the probability that a well will be drilled in the area that may be affected is less than 0.1. In the case of SFR 1, this line of reasoning is in accordance with the recommendations given in the general advice on the application of SSM's regulations SSMFS 2008:37, since SKB compares the calculated risk with the criterion of  $10^{-6}$ . Had SKB instead, as in FSR 2001, chosen to compare the calculated risk with the risk criterion of  $10^{-5}$ , which can be used if only a small group of people are assumed to be exposed, a probability of 1 should be used instead in the case of SFR 1 for this type of exposure pathway. This account is thus an improvement compared with the previous safety analysis report.



The most important objection to SKB's choice of scenarios and calculation cases concerns the evaluation of the expected gradual degradation of the barriers. SSM is of the opinion that SKB's handling of this matter is inadequately accounted for, which was also pointed out in the review of FSR 2001 (Dverstorp et al. 2003). SSM's consultants (Zhou et al. 2009) assert that SKB's far-reaching conclusion regarding the safety functions "low-advective transport" and "sorption", which are claimed to be maintained over very long periods of time, are difficult to justify without relevant field or analogue data. SSM's consultants' independent calculations with an alternative model show that the maximum releases – taking into account a hypothetical degradation of the barriers – could affect the calculated doses by a factor of between 15 and 30 (Zhou et al. 2009). SSM therefore considers it urgent that SKB's account be supplemented by additional calculations and/or more convincing arguments.

Aside from this viewpoint, the Authority would like to offer the following viewpoints that may need to be observed in future safety analysis reports.

- *Influence of gas.* SSM shares the opinion of Zhou et al. (2009) that SKB has not explained sufficiently clearly why the calculation case "influence of gas" can be excluded from SKB's main scenario. The calculation case for influence of gas is instead regarded as a less probable scenario in SKB's analysis, but is nevertheless assigned a probability of 1 in the risk evaluation. This means that SKB has handled the matter in a correct manner as regards calculated risk, but SSM nevertheless considers that the justification of the scenario descriptions in SAR-08 can be improved.
- *Analysis of uncertainties in the inventory of radionuclides.* SSM is of the opinion that it is doubtful whether SKB's assumption of a symmetrical distribution of the uncertainties regarding the inventory around the central value is correct. A special calculation case should instead be focused on whether a reasonable estimate of remaining inventory uncertainties for the whole expected operating period of SFR could lead to a considerably higher dose/risk in comparison with the main scenario. According to Section D3.2, the most important uncertainties for the risk analysis should be associated with the inventory of carbon-14 in the repository parts BMA, BTF and BLA.
- *The importance of future intrusion.* A limitation is that the evaluation of the impact on the repository's protective capability due to an intrusion in the form of a well is restricted to an evaluation of the water flow in BLA. SKB's discussion of the cumulative probability of an intrusion is deemed credible, but in future assessments SSM would like to see some form of analysis of the importance of the direct impact on the engineered barriers in the most advanced repository parts, BMA and the silo, or clarification that this is of no importance for the function of the repository.

## Handling in SR-PSU

### Gradual degradation of barriers

In SR-PSU, SKB has conducted further assessments concerning the barrier evolution over time, as summarised in Section 6.3.8. SKB has concluded that a barrier degradation can be expected to occur earlier than was estimated in SAR-08. In its modelling for SR-PSU, SKB accounts for a gradual barrier degradation in the main scenario, as explained in Section 7.4.3.

### Influence of gas

Gas formation will cause contaminated water to be expelled into the buffer or backfill around the concrete structure and finally into fractures in the rock surrounding the vaults. The amount of water expelled depends on the increased pressure in the vaults caused by the gas generation. Water expulsion could happen within the first few years due to the rapid corrosion of aluminium. If this happens, the expelled water will contain very limited amounts of radionuclides so the impact will be limited. The 2BMA vault will be constructed in such a way that generated gas will be able to escape from the waste domain without expelling any contaminated pore water. See Sections 6.3.7 and 6.3.8.

### Uncertainties in the inventory

In SR-PSU, one less probable scenario, the *high inventory scenario*, is selected to evaluate uncertainties in the initial inventory (measurement uncertainties, uncertainties in correlation factors and uncertainties in other methods used to calculate the best estimate inventory that is used in the main scenario). The 95th percentile values for each radionuclide in each waste vault are used to illustrate the influence of a higher inventory. Like all less probable scenarios this scenario has been evaluated with dose and risk calculations. See Sections 7.6.1, 9.3.1 and Chapter 10.

### Importance of future intrusion

SKB has carried out an extensive analysis in SR-PSU of the chances that a future population will drill a well on a particular site in the area. This analysis is based on e.g. the suitability of the landscape for the establishment of a human settlement, considering such factors as the cultivability of the soil. In this way, a number of sites in the area have been identified as possible sites for wells. The hydrological properties of these wells have then been analysed by hydrological calculations to ascertain how large a fraction of the radionuclides released from the repository could reach these wells. SKB's approach to the well analysis has thus been refined compared with the previous approach, which was based on a purely statistical line of reasoning. The impact of water/exploration drilling on the the barriers of the repository is discussed in the **FHA report**.

The effects of water and exploration drilling on the barriers are considered to be small. In the residual scenario *loss of barrier function scenario - high water flow in the repository*, the effect of lost barriers and a high flow through the repository are analysed. A borehole through the repository will not give rise to a complete loss of the barriers and thus less flow through the repository is expected for a borehole intrusion than is seen in this scenario. Nevertheless, the *loss of barrier function scenario - high water flow in the repository* can be seen as an upper limit for effects on the barriers from a borehole. However, given the relatively small area of a borehole, the effects of a borehole on the flow through the repository ought to be small and the influence of water or exploration drilling on the barriers can be considered negligible from a radiological point of view.

## D3.6 Method for consequence analysis and calculation cases

### D3.6.1 SKB's account

SKB's method for dose calculations is divided into two parts: releases from the geosphere and the dose factor (DF) for unit releases of various radionuclides to the biosphere. The dose to humans is calculated by multiplying the dose factor by the geosphere releases.

### D3.6.2 SSM's assessment of SKB's account in SAR-08

SSM believes that the disadvantage of SKB's method for dose calculations is that it has not been possible to analyse certain processes in the system. An example is that radionuclide transport through Quaternary deposits has not been included in the system. SKB states that radionuclides that are calculated to occur directly in the top sediment or in the aqueous phase give a higher dose than those that are calculated to be released via Quaternary deposits and notes that this is a conservative assumption (Bergström et al. 2008). Accumulation of radionuclides in Quaternary deposits may, however, delay the travel time, which could affect the environment to which the radionuclides are ultimately released. Because the SFR 1 system is complex, SSM therefore finds that it is not simple to determine whether SKB's assumption in this case is conservative, at least not without a more in-depth analysis. SSM therefore considers that the consequence analysis in future evaluations should be done on the whole system for the final repository instead of separating it into two parts (geosphere and biosphere).

### Handling in SR-PSU

In SR-PSU, SKB uses a code for radionuclide transport where all subsystems (near-field, geosphere and biosphere) can be run coupled in the same model. Accumulation in sediments is thereby automatically integrated in the simulations.

## D3.7 Hydrogeology

### D3.7.1 SKB's account

SKB's account of hydrogeological conditions was based on the calculations that were carried out in conjunction with the 2001 safety analysis report 2001 (mainly Holmén and Stigsson 2001a,b). The calculations included modelling studies that estimated the future groundwater flows through the repository parts of SFR and the surrounding rock. SKB reported transport pathways from the repository to the surface as well as associated advective travel times for two periods (the next 1,000 years and from 3,000 to 20,000 years).

In addition to the material from the previous safety analysis report, SKB has published three more studies (Holmén 2005, Holmén 2007, Vidstrand et al. 2007) in response to the comments made by the regulatory authorities in the previous review report (Dverstorp et al. 2003). The purpose of SKB's new studies is uncertainty analyses for the modelled water flows and the flow paths from the repository parts. For the time span 20,000 to 100,000 years in the future, the purpose is to estimate how much the flows are changed as the climate evolves.

### D3.7.2 SSM's assessment of SKB's account in SAR-08

SSM considers it an improvement compared to the material presented in the previous safety analysis report. SKB has now arrived at an acceptable method to deal with the uncertainties in the hydraulic properties of the rock and has carried out an evaluation of the uncertainties in the parameterisation of the models. SKB has also addressed the questions concerning the influence of flow measurements in open tunnels on the parameterisation of the hydraulic properties of the rock under water-saturated conditions. SSM finds that the order of magnitude of SKB's flow predictions appears reasonable.

However, SSM still finds it difficult to judge whether the uncertainties in the flow modelling are adequately reflected in the results. SSM judges that the coupling between relevant data and the parameterisation of the models is not properly accounted for. The main reason for this is that SKB gives no explanations or quantitative arguments for the assumed parameter values and parameter distributions and makes no judgement of whether they can be considered to be realistic or conservative. Besides addressing the questions surrounding the reporting of the parameterisation of the models, SSM would also like SKB to present a well-founded discussion of the applicability of the different model variants and which should be used in the consequence analysis calculations.

SSM finds the following to be particularly urgent:

- *SKB needs to substantiate the statistical distributions for the different parameters (Chapter 5 of Holmén 2005) with site data, generic data or quantitative arguments.* SSM finds these distributions to be of central importance for the hydrogeological calculations, in particular in view of the fact that the parameter distributions are in most cases not limited by the tests against inflow data. In other words, it is likely that the model can provide an acceptable fit to flow data even with parameters that lie outside the assumed parameter distributions.

As regards transmissivity in the different fracture zones, SSM would like to see a discussion of how the mean values presented in Table 5-2 (Holmén 2005) are relevant to the parameterisation of the distributions of transmissivities in the model. The measured transmissivities from the single-hole and cross-hole tests (Axelsson and Mærsk Hansen 1998) exhibit a span of several orders of magnitude. SSM would like to see a discussion of how this spread, which can be attributed to data uncertainties and the heterogeneity of the rock, influences the choice of the distributions. SSM deems it likely that channelled flow paths exist and therefore thinks SKB should show how this is reflected in the parameterisation. In the previous review report (Dverstorp et al. 2003) it was pointed out that there are indications of additional fracture zones in the repository area. SKB should explain how such uncertainties are taken into account in the model.

When it comes to the hydraulic conductivity of the rock mass, SSM would like to see a discussion of the relevance of the distribution. The estimated value around which the distribution is centred appears to be taken from the calculation on page 31 in Holmén and Stigsson 2001a. SKB needs to explain why this assumption is also relevant when skin effects are taken into account.

When it comes to the skin factor, SKB needs to explain the relevance of the assumed statistical distribution in the absence of such a discussion in Chapter 5 of Holmén (2005). SSM notes that SKB has collected data on inflow to open tunnels during, for example, the Stripa "simulated drift" experiment and the "site characterisation validation drift" experiment (Olsson 1992).

SKB needs to explain why the assumption of a uniform value for porosity in and between fracture zones and repository parts (Holmén 2007, page 15) can be considered to be conservative. SKB justifies the uniform value by saying that it facilitates comparison of transport resistances (the "F-factor") calculated via different approaches. SSM believes that the variability and uncertainty of the F-factors will be underestimated with this assumption and considers it unclear whether the assumption is conservative or not.

- *SKB needs to improve the discussion of which model variants in Holmén (2005) should be carried further to subsequent calculations.* SSM judges that SKB needs to carry relevant variants further unless they can be ruled out on good grounds.

SKB argues in Holmén (2005, page 87) that the range of flow values is too wide in the model variant that reflects the heterogeneity in the rock between the fracture zones. SKB asserts that the realisations of the permeability field may differ significantly from the structural geological interpretation. Based on this argument, SKB rejects the model variant in the subsequent calculations (Holmén 2007, page 35). SSM is of the opinion that SKB's argument is not supported by experience from the site investigations in Forsmark (SKB 2008). This shows that there might be a wide spectrum of fracture zones on scales that are smaller than those that are normally deterministically mapped in the site investigations. SSM is also of the opinion that such structures can lead to spatial correlations of permeability on a block scale and that it is a weakness that SKB does not take such correlations into account. Furthermore, SSM is of the opinion that even if SKB can show that certain realisations are irrelevant, this is not a reason to disregard all realisations. SSM further notes that the "base case" that is carried further to subsequent calculations appears to lead to more optimistic results than the other variants.

- *SKB needs to show that the ventilation air does not remove significant quantities of water from the tunnel system that could affect the calibration of the flow model.* Reference is made on in Holmén (2005), page 37, to "personal communication" to argue that this is not the case. SSM is of the opinion that an argument that is of importance for demonstrating the safety of the final repository should be traceable to a written report. Furthermore, SSM finds that SKB's explanation does not clarify whether this claim applies to the whole tunnel system or specifically to the BMA tunnel in which the inflow measurements were used to estimate the hydraulic conductivity (Holmén 2005, Table 5-2).

The Authority considers quality assurance of the calculations to be important. SSM would, for example, like to know how random samples are taken from the parameter space in the inverse modelling. SSM believes that this knowledge is necessary to judge whether the uncertainties in the parameterisation are handled in a suitable manner. The Authority would also like SKB to explain what status the "Model summary report" has in relation to the flow modelling, in view of the fact that the modelling studies do not refer to this but to other sources. SSM notes that there is no information in the model report regarding how input data has been archived.

In addition to these urgent needs, other improvements may be needed in the longer term, such as in connection with the updating of future safety assessments. SKB should review the presentation of the hydrocalculations under different climatic conditions (Vidstrand et al. 2008). SSM notes that there are a number of examples of minor weaknesses, e.g. a lack of explanations and inconsistencies in the presentation<sup>19</sup>. However, the Authority judges these weaknesses to be of such a character that they do not significantly influence the risk assessment.

<sup>19</sup> SKB contends that the results in the report show the same general behaviour as the results in Holmén and Stigsson (2001a) and that this increases confidence in the results. It is unclear to SSM what this judgement is based on.

SSM considers it unclear how the hydraulic conductivity assumed in Vidstrand et al. (2007 p. 34) follows from the study by Holmén and Stigsson (2001a), which uses a different model and represents regional zones separately.

SSM has difficulty understanding why SKB presents scenarios with fracture zones around the repository which in SKB's account are not considered applicable (Vidstrand et al. 2007 p. 64). SSM notes that the calculated flows in the zones in temperate conditions are unrealistically high.

SKB asserts that the results from Vidstrand et al. (2007) can be used in the safety assessment with a suitable measure of caution, given conservative parameterisations and boundary conditions. SSM finds no discussions of a suitable measure of caution in the use of the factors in later modelling (Thomson et al. 2008 p. 38). For example, the assumption in Vidstrand et al. (2007) concerning the size and direction of the measurement volumes in relation to the flow directions in the model appears to be of importance for the factors.

SKB attaches importance to the visualised results in the discussion. SSM notes the remarkable results that are presented in e.g. Figure 3-14 and believes that SKB should choose a software that is able to reproduce the calculations results in a correct manner.

SKB argues that the repository is located on the shady side of a hill and will therefore freeze at an early stage of permafrost evolution. Given this argument, SSM considers it unclear why the calculations for partial permafrost conditions assume that the permafrost areas are situated on the topographical peaks.

### **D3.7.3 SSM's assessment of SKB's account in SAR-08**

It is difficult for SSM to judge whether the uncertainties in the flow modelling are reflected to a sufficient degree in these results. As noted above in the review comments under D3.7.2, SSM would like to see arguments for the assumed parameter distributions and the assessment of their conservatism. In addition, SSM would like a well-founded discussion of which model variants can be rejected. SKB also needs to explain in detail the importance of the ventilation air for the hydrological calibration.

SKB could respond to these questions by supplementing the calculations with relevant information and discussions based on available material. However, this presumes that the calculations adequately reflect the uncertainties.

#### **Handling in SR-PSU**

SSM's comments concerns the hydrogeological modelling that constituted the basis for SAR-08. That modelling was based on the information and modelling methodology available at that time. This included information obtained from the investigations conducted prior to the construction of the existing facility, SFR 1, and from the flow modelling tool GEOAN (Holmén and Stigsson 2001). A discussion of the credibility of models and parameter distributions was based on knowledge of the site and a description of its properties.

Since SAR-08, SKB developed the site descriptive model for the SFR area in connection with the construction of a new site descriptive model (SDM) within the SFR Extension Project (PSU). SDM-PSU (SKB 2013e) includes a large number of new boreholes, fracture mappings and hydraulic tests, which has led to a great increase in the quantity of site data compared with what was available for SAR-08. This means that the parameters used today can be justified much more convincingly than in SAR-08. The response to the comments is therefore based on the total body of information, including the new information that has become available. SDM-PSU is used as a basis for the analyses prior to the extension of SFR. Furthermore, the flow modelling tool GEOAN has been replaced by DarcyTools (Svensson et al. 2010), which offers better options for modelling the structures and properties of the bedrock.

New hydrogeological modelling for different climatic conditions have been performed within SRPSU, with new or modified modelling assumptions and boundary conditions compared with the SAR08 modelling. The comments from SSM on the presentation of the hydrocalculations under different climatic conditions in SAR-08, given in the footnote 2 above, are therefore out of date. The new modelling is presented in Odén et al. (2014).

#### **SKB needs to substantiate the statistical distributions for the different parameters (Holmén 2005, Chapter 5) with site data, generic data or quantitative arguments**

The comment does not explicitly mention which parameter distributions are being referred to. The following parameters are identified in SSM's review report:

1. Transmissivity of deformation zones.
2. Conductivity of the rock mass.
3. The "skin factor" that is used to calibrate the model against measured water inflows in tunnels and rock vaults.

Besides the skin factor, the parameters are based on knowledge of the site and the degree of detail in the site model.

"Given parameter distributions" are presented in SAR-08 in Table 5-2 in Holmén (2005). Intervals spanning two orders of magnitude have been used for both deformation zones (transmissivity values) and rock mass (conductivity values). An interval of 0.05 to 0.1 has been used for the skin factor. The distributions, specifically for the transmissivities of the deformation zones and the conductivities of the rock mass, include estimated mean values.

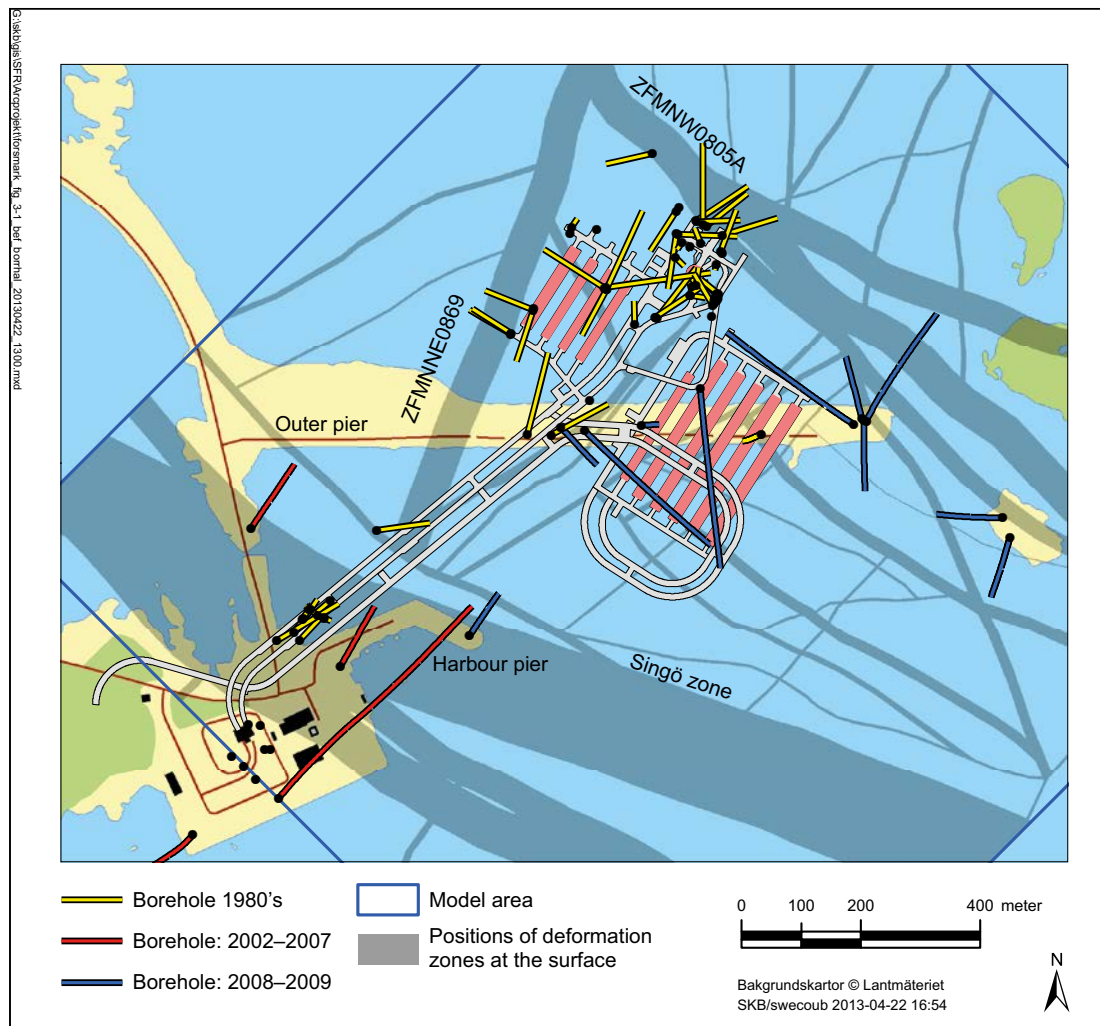
The assumed distributions should be regarded as sensitivity analyses or uncertainty analyses rather than as expressions of a knowledge of the natural spatial heterogeneity of the site. When SAR-08 was carried out, only one limited data set was available. This is reflected in the set-up of the analysis with a generic sensitivity analysis.

Prior to the safety assessment in the SFR Extension Project, SR-PSU, a site investigation was conducted to learn more about the characteristics of the site, including its hydrogeological properties (SKB 2013e, Section 4.8.1). The new type of available data meant that a different modelling methodology could now be used than the one used in SAR-08. SR-PSU has used a modelling methodology based on the methodology used and experience gained in the safety assessment project SR-Site.

### Completed site investigations – knowledge of the site

As mentioned above, the applicability of the models and parameters that are used is based on knowledge of the site to be modelled and the degree of detail in the model. Holmén and Stigsson (2001) concluded that the greatest source of uncertainty in their results was limited knowledge of the site. Today's greater knowledge of the site is based on additional data from two periods (see Figure D-1):

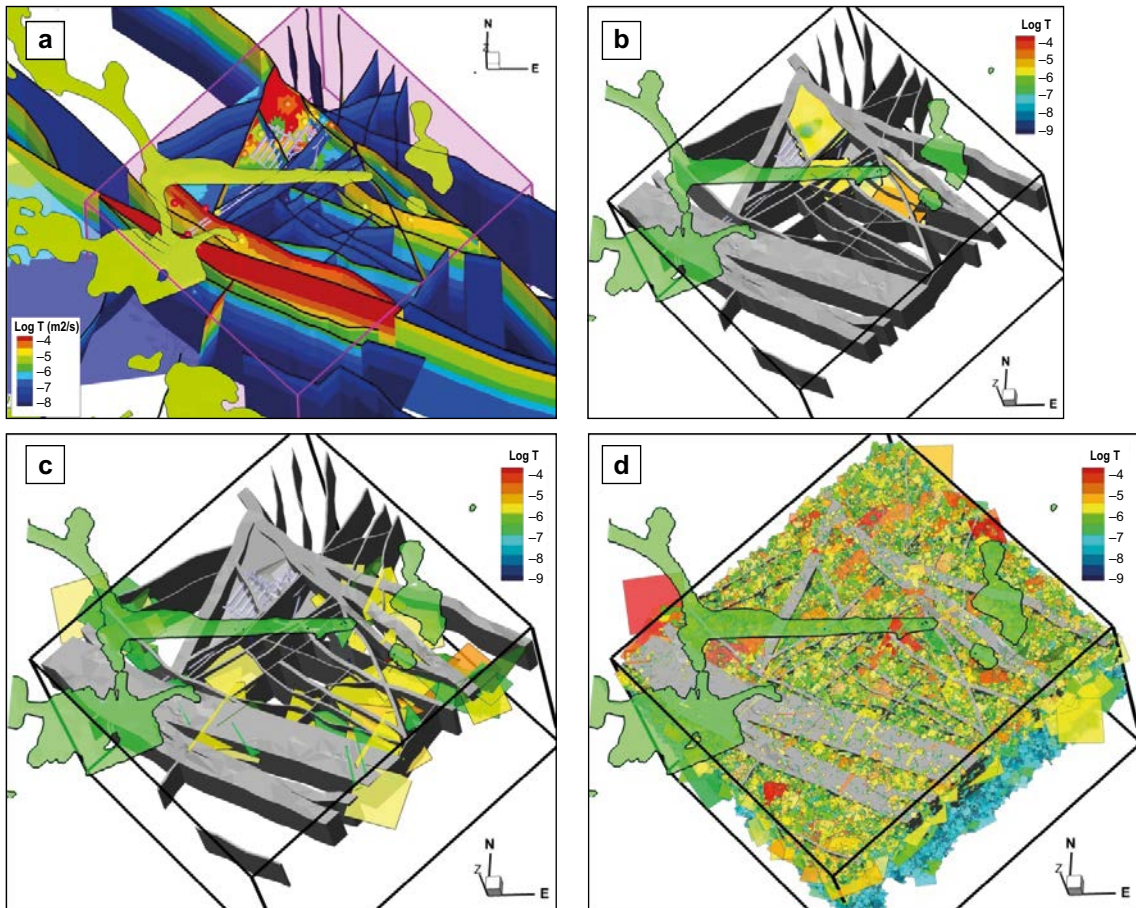
1. *Investigation boreholes in the SFR area drilled during the period 2002–2007.* The boreholes were drilled in conjunction with the site investigations for the Spent Fuel Repository. The investigation results from these boreholes have been used in the Nuclear Fuel Project, but it has also been possible to use some of the boreholes as a basis for further analyses of SFR and the area for the planned extension.
2. *Investigation boreholes drilled during the period 2008–2009 within PSU.* Twelve investigation boreholes were drilled within the SFR Extension Project. All boreholes except three were drilled from the pier with a focus on the area southeast of SFR 1. Of these three, two were drilled from an islet southeast of the pier, while the third was drilled nearly horizontally underground from SFR 1.



**Figure D-1.** Locations of investigation boreholes in the SFR area. Holes drilled in the 1980s prior to the establishment of SFR 1 are shown in yellow, holes drilled during the site investigations for the Spent Fuel Repository during the period 2002–2007 are shown in red, and holes drilled during the period 2008–2009 during the site investigation within PSU are shown in blue.

The site investigation programme resulted in a site descriptive model that includes a hydrogeological model, among others. The updated hydrogeological model (Odén et al. 2014) consists of four types of structures: HCDs (Hydraulic Conductor Domains), SBAs (Shallow Bedrock Aquifers), Unresolved PDZs (Possible Deformation Zones) and DFNs (Discrete Fracture Networks), see Figure D-2. HCDs and SBAs are modelled deterministically, while PDZs and DFNs are modelled stochastically. The stochastic objects, PDZs and DFNs, are designated with a name for the HRD (Hydraulic Rock mass Domain).

- HCDs: Deterministically modelled structures (geologically interpreted deformation zones, DZs) with hydraulic properties taken from both old and new hydraulic measurements. There are 40 HCDs in the SFR area.
- SBAs: Deterministically modelled structures which, according to hydrotest data (flow logging in individual boreholes, pressure responses during drilling and directional interference tests) can be interpreted as representing zones of transmissive and preferably gently dipping fractures where orientation data comes from fracture data in studied boreholes. Eight SBA structures have been modelled.
- Unresolved PDZs: Stochastically modelled structures which, according to hydrotest data, occur near major deformation zones.
- DFNs: Stochastically modelled structures (fractures).



**Figure D-2.** Examples of the four hydraulic structures used to describe the rock in the SFR area: a HCDs, b SBAs, c Unresolved PDZs, and d DFNs.

The additional information obtained from the two aforementioned site investigation periods permits a heterogeneous and anisotropic description of both deformation zones and the intervening rock. The updated site model also entails that:

1. Statistical information concerning the orientation and transmissivity of single fractures is available for the part of the area affected by the planned extension. The rock mass between deformation zones has thereby been possible to describe with a Discrete Fracture Network, DFN. The modelling methodology is explained in Öhman et al. (2012, 2013).
2. The occurrence of deterministically modelled deformation zones (DZs) in the SFR area has been updated (Curtis et al. 2011) and covers a larger area than SAR-08. The number of DZs has increased to 40 in PSU, compared to SAR-08 where 8 DZs were modelled deterministically.

### **SKB needs to improve the discussion of which model variants in Holmén (2005) should be carried further to subsequent calculations**

Using four model variants, Holmén and Stigsson (2001) investigated the uncertainty related to precipitation and the hydrogeological description of the rock. Additional model variants were added in Holmén (2005) with respect to the description of the rock as a complement to Holmén and Stigsson (2001). The uncertainty factors calculated in Holmén (2005) are used together with the tunnel flows presented in Holmén and Stigsson (2001). Consequently, the conceptual descriptions in Holmén (2005) and Holmén and Stigsson (2001) should be reasonably similar. The “base case” was therefore propagated to the subsequent calculations, and the other cases were regarded as sensitivity cases that were executed to gain a better understanding of how the studied system works.

Additional model variants have been investigated in the supplementary modelling (Odén et al. 2014), these are discussed in detail in Öhman et al. (2014) and summarised below with a focus on hydrogeological model variants.

#### *Supplementary modelling – knowledge of the site*

As an initial step, 99 realisations of HRDs (i.e. PDZs and DFNs) were generated. A statistical analysis was carried out where two realisations were selected to represent extremes in the 99 realisations (SKBdoc 1395200) with respect to expected flows through the rock vaults in SFR 1:

1. R18, an optimistic realisation (few large fractures intersect SFR 1).
2. R85, a pessimistic realisation (a large number of large fractures intersect SFR 1).

It was then analysed (SKBdoc 1395214) how the combination of the description of HCDs, SBAs and HRDs influences: 1) flows through rock vaults, 2) discharge points and 3) advective travel time (since the work was done within SR-PSU, the interaction between SFR 1 and a planned extension was also studied). In all, 62 different hydraulic parameterisations of the rock were tested:

- Homogeneous HCDs combined with 21 HRD realisations (R1-R20 and R85).
- Homogeneous HCDs, but with an increased geometric extent of the gently dipping zone ZFM871, combined with 21 HRD realisations (R1-R20 and R85).
- Ten heterogeneous HCD realisations, each combined with 2 HRD realisations (R18 and R85).

The analysis shows that the flow through the rock vaults is more dependent on the parameterisation of HCDs than of HRDs (this is even clearer in the area for the planned extension). Based on the results of this study, 17 different model variants of the rock were designed (Öhman et al. 2014) for further analyses under temperate climatic conditions. In addition to the two previously selected HRD realisations, R18 and R85, another realisation is being studied, R03, where a large number of large fractures intersect the area for the planned extension. These three HRD realisations were combined with 10 different descriptions of HCDs (with respect to depth trend, heterogeneity and conditioning against borehole data) so that a total of 17 model variants are being tested. The 17 model variants, which are presented in Öhman et al. (2014, Section 2.2), were designed to capture the uncertainty/variability in the parameterisation and because to some extent they bound the flows through the rock vaults.



The results of all 17 model variants will go on to analysis of radionuclide transport. For hydrogeological simulations under permafrost conditions, and for detailed calculations of the flows through the rock vaults, three hydrogeological model variants were selected from the above alternatives to represent the uncertainty/variability in the description of the rock's hydraulic properties:

1. A variant with low flows through the rock vaults.
2. A base case with medium flows through the rock vaults.
3. A variant with high flows through the rock vaults.

The procedure for selecting these 3 cases is described in detail in Öhman et al. (2014, Section 6.2.3). Model variants based on uncertainties in groundwater recharge (depending on the properties of the SFR pier) and other climate parameters, such as temperature, have been studied by means of bounding models (SKBdoc 1395215, Odén et al. 2014).

### **SKB needs to show that the ventilation air does not remove significant quantities of water from the tunnel system that could affect the calibration of the flow model**

The review of SAR-08 questioned how the calibration of the flow model was done against inflows to SFR 1, in view of both the importance of the ventilation air and the parameterisation of the skin factor. In the updated model, the parameterisation has been based on hydraulic measurements in investigation boreholes. This has been done in part to avoid conceptual uncertainties concerning how measured inflows should be interpreted and used (the inflows have decreased by about 60% since the first measurement, Section 4.8.2), but also because the area for the planned extension contains deformation zones with little or no connection to the inflow to SFR 1. The inflows to SFR 1 are used in the updated model to check that the parameterisation yields inflows of the correct order of magnitude (Öhman et al. 2013). The parameterisation of the different hydraulic structures in SR-PSU is described in detail in Öhman et al. (2012) and summarised in SDM-PSU (SKB 2013e, Chapter 7). The final parameter distributions used in SR-PSU are presented in Öhman et al. (2014, Chapter 4). In Öhman et al. (2014), uncertainties in the parameterisation of the hydrogeological units are also taken into account in a sensitivity analysis of different model variants.

## **D3.8 Analysis of engineered barriers**

### **D3.8.1 SKB's account**

A partial degradation of barriers such as cement structures and bentonite is expected to occur during the period when safety functions are required (the period up to 100,000 years). The assessment of the degradation of the barriers is a central theme in the safety assessment, since involved processes are expected to entail an elevated risk due to a more rapid leakage of radionuclides. Physical and chemical degradation can lead to a deterioration in both the tightness and transport properties of the barriers, while altered chemical conditions can lead to poorer retardation of radionuclides. A degradation of cement is represented in the consequence calculations by the elevated groundwater flows that are obtained after the hydraulic conductivity of the material has been increased by several powers of ten (from about  $10^{-9}$  m/s to  $10^{-5}$  m/s). Some fracturing of the cement is assumed to exist from the start (e.g. minor fractures from the hardening phase). This can be handled by using a higher value for hydraulic conductivity in the analysis of the expected value for completely fracture-free cement (about  $10^{-10}$  m/s).

In the case of the BTF repositories, SKB predicts in SAR-08 that the cement structures will degrade after the initial 1,000-year period. The BMA and silo repositories are expected to have a much longer life, and degradation in SKB's safety assessment is mainly associated with major climate-induced changes such as permafrost and glaciation (no barrier functions are assumed for the BLA repository). During the period with severe permafrost around 40,000 years, it is assumed that the cement structures around BMA will burst due to freezing. The bentonite around the silo is assumed to remain intact for nearly 60,000 years, but dilute meltwater could then erode this barrier. Major earthquakes could potentially also lead to extensive degradation of barriers, but this case is taken up separately in Section D3.10. Other types of mechanical impact on the barriers due to e.g. subsidence or the build-up of gas pressure (from corrosion of metals) cannot be completely ruled out either, according to SKB.

Cement structures in the different repository parts and the bentonite barrier in the silo will slowly degrade in contact with groundwater. In the case of cement, this is due to a slow leaching and chemical transformation of the main components portlandite and calcium silicate hydrate, which is accompanied by a gradual reduction in the strength of the material. Reactions inside the cement that give rise to new minerals with high molar volume can furthermore cause internal fracturing. In the case of bentonite in direct contact with cement, the clay mineral montmorillonite is transformed to minerals with poorer self-sealing capacity. Except in the case of BTF and BLA (without robust cement barriers), SKB does not believe that these gradual transformation processes will affect the long-term protective capability of the repository during the period barrier functions are required. As a basis for this claim, SKB cites detailed modelling studies by e.g. Cronstrand (2007), Gaucher et al. (2005) and Höglund (2001). These studies show that chemical transformations can be locally extensive but that the penetration depth for chemical transformations is limited so that the waste material inside concrete walls and bentonite is only affected to a small extent. Cronstrand (2007) shows, however, that considerable fracturing and large changes in permeability in the cement induced by permafrost or other causes can lead to considerably faster degradation.

Yet another category of processes that need to be considered is that components in the waste are released and react with the surrounding cement. Examples are formation of the swelling mineral ettringite from the release of sulphate from ion exchange resins, carbonatisation due to carbon dioxide formation from degradation of organic material in the waste, or release of salts from evaporator concentrates. Corrosion of rebar can also lead to local fracturing. SKB points out that there is an expansion volume available to absorb the volume increase associated with these processes. However, SKB does not exclude the possibility that a local impact on porosity and fracturing can occur in these cases.

In accordance with applicable regulations (SSM 2008:21), SKB describes the probable evolution of the cement and bentonite barriers in a main scenario. This includes degradation of the barriers in the BMA repository and the silo after periods of extensive permafrost and glaciation as described above. Furthermore, SKB describes a scenario with early freezing of the repository when the concrete barriers in the BMA repository burst due to freezing after about 25,000 years (the silo repository is not considered to be affected since this repository part also has a bentonite barrier, which also limits the groundwater flow). SKB judges this scenario to be less probable, but SKB nevertheless assumes a probability of 1 in the summation of risk, since data are not available to estimate an actual probability. SKB also describes a residual scenario associated with barrier degradation (i.e. a scenario that is included to illustrate the importance of degradation for different barrier functions without reference to its actual probability). Here it is assumed that the repository's cement and bentonite barriers have largely lost their flow-limiting properties at the time of transition between coast and lake (at 5,000 years).

### **D3.8.2 SSM's assessment of SKB's account in SAR-08**

SSM considers that the understanding of barrier degradation and its importance has been improved with SAR-08. The biggest change compared with previous safety assessments is the extended time scale to 100,000 years, which makes it possible to take into account the impact of climate change on the long-term durability of the barriers. Since FSR 2001, SKB has also compiled additional data for assessment of chemical processes involved in slow reactions between groundwater and cement/bentonite (e.g. Cronstrand 2007, Gaucher et al. 2005) as well as freezing and thawing of cement/bentonite (Emborg et al. 2007). The study by Cronstrand can be considered a great improvement compared with earlier efforts, which Savage (2009) also points out. It discusses certain matters taken up in the regulatory review of FSR 2001, including temperature variation, salinity variation, dynamic porosity evolution, and fracturing and its connection to accelerated chemical transformation.

However, SSM is of the opinion that the degradation of cement/bentonite and its impact on long-term radiation safety remains difficult to assess despite these additional studies. This judgement is mainly based on certain deficiencies in representation and argumentation concerning barrier degradation effects, mainly in the main scenario. The judgement is also linked to the fact that SKB's account provides very limited insights into how extensive barrier degradation must be to have a significant impact on dose/risk. SKB's approach for taking degradation of barriers and tunnel plugs into account is still the same as in FSR 2001, when the consequence analysis calculations were based on an instantaneous increase of hydraulic conductivity in concerned repository parts by several powers of ten. The method is simple but provides no basis for assessment of the expected gradual and heterogeneous course of barrier degradation.

Since no barrier changes are included in the main scenario for a period up to 40,000 years, SSM cannot exclude the possibility that this is an optimistic rather than a realistic case. While the special case “early degradation of barriers” shows the influence of an extensive and possibly bounding degradation, this case gives too great consequences and is probably too conservative to serve as a basis for an assessment of compliance with requirements.

The accelerated concrete degradation scenario shows the impact of a more severe degradation than considered in the main scenario.

SSM finds the following to be particularly urgent:

- *Better substantiate the main scenario as a basis for assessment of compliance with SSM’s risk criterion.* An additional calculation case is needed showing the effect of reasonable barrier degradation on the characterisation of risk, or alternatively a more detailed explanation of why the effect of all reasonably probable barrier degradation processes can be ruled out for a period up to 40,000 years for the repository parts BMA and silo.
- *Provide a better body of material for assessing the risk of freezing of cement barriers during the period with permafrost at around 10,000 years that is included in the extreme permafrost scenario.* The margin to freezing is small even in the scenario based on the last glacial cycle. This may include a better investigation of the temperature at which the cement in question is expected to remain intact. Better knowledge of the freezing point reduction in cement is of importance, since the extreme permafrost scenario includes a period with considerable permafrost after only 10,000 years. If the repository were then to burst due to freezing after 25,000 years, the dose effects during the subsequent temperate phase would be greater than those now reported.  
*Augment and update the account justifying the handling of the interaction between waste material, rebar and cement.* It is not apparent from SKB’s account that all of these processes can be handled solely by referring to an “available expansion volume” in the repository. SKB’s formulations in SAR-08, Section 6.4.4, show that questions remain that need to be handled with reference to a traceable body of data. It can be concluded that no substantial improvements have been made in this area since FSR 2001. These processes have a potential to contribute to some extent at least to fracturing of the cement matrix, which can accelerate both the escape of radionuclides and the continued chemical degradation process.

In addition to these other urgent needs, efforts in the following areas may be needed in the longer term, such as in connection with the updating of future safety assessments:

- Improve and refine the representation of barrier degradation in the analysis of hydrogeology and risk. For example, it can be observed that Holmén and Stigsson (2001) only discuss substantial instantaneous changes in permeability. Aside from the fact that this is a great simplification, it is also unclear how large a part of the repository the permeability change actually concerns in the implementation of the results in SAR-08. Barrier degradation can be studied more closely in different ways, for example by sensitivity analyses (which show to what extent parameters such as porosity and diffusivity have to be changed to significantly affect radionuclide transport) or by model studies with explicit representation of fractures in the cement matrix (Chambers 1995). Such model studies can be used to obtain a more detailed understanding of outward transport of radionuclides both via advection and via diffusion as well as to provide a better body of data to justify the coupling between different barrier degradation processes and radionuclide transport.
- If it is possible to make relevant comparisons with natural or anthropogenic analogues, these should be included in the safety assessment (Zhou et al. 2009).
- The extent of damage after freezing may need to be studied further. The conclusion in Emborg et al. (2007) is conservative that the cement after freezing/thawing is to be regarded as sand/gravel (compare with e.g. Cronstrand, who assumes a progressively advancing degradation with each freeze/thaw cycle). However, the study is somewhat perfunctory with respect to a conclusion of such great importance for final disposal.
- The assumption that the bentonite around the silo regains its protective properties after a freeze/thaw cycle and is not affected by a degradation of the surrounding concrete barriers needs to be further substantiated. The only reference for this, which is found in Emborg et al. (2007), is oral communication with L. Börgesson in 2007. SKB may also need to take into account new knowledge that is being gathered in the ongoing buffer erosion project (within the project “final disposal of spent nuclear fuel”) in connection with new assessments of the durability of the bentonite barrier around the silo.

There are factors that suggest that a late barrier degradation in conjunction with major climate change does not have as great an effect on the radiation safety of the repository as the earlier effects during the first few thousand years. This can be shown by comparing the calculation cases “extreme permafrost” and “early degradation of barriers”. An extensive barrier degradation associated with climate change also leads to similar risk increases (during coming interglacials from e.g. iodine-129, nickel-59), but when carbon-14 has decayed the doses are considerably lower, as SKB’s analysis shows. However, this presumes that there is no risk of large additional contributions by redox-sensitive nuclides (see Section D3.9).

## Handling in SR-PSU

### Degradation of barriers

In SR-PSU, SKB has extended the assessment of long-term barrier evolution, as summarised in Section 6.3.8. SKB has concluded that a barrier degradation can be expected to occur earlier than was estimated in SAR-08. In its modelling for SR-PSU, SKB accounts for a gradual barrier degradation over time in the main scenario, as explained in Section 7.4.3. The main scenario is complemented by the scenario *accelerated concrete degradation* (Section 7.6.3) and the scenario *loss of barrier function – high flow in the repository* (Section 7.7.3), to further improve the understanding of how the degradation of concrete barriers affects the performance of the repository.

### Risk for early freezing

The risk for early freezing has been re-evaluated. New investigations of the freezing point of the concrete have been made. See Section 6.2.3.

### Interactions among waste material, rebar and cement

Sections 6.3.7 and 6.3.8 summarise the updated account of interactions among waste, rebar and cement. Supporting studies have included models where discrete fractures in the cement matrix have been represented.

### Representation of barrier degradation in the analysis of hydrogeology and risk

The near-field hydrology model has evaluated the impact of barrier degradation on the flow through the repository (Abarca et al. 2013). A series of degradation steps, from the initial state to a completely degraded state, have been considered. The corresponding flow fields serve as input to the radionuclide transport calculations, as detailed in the **Radionuclide transport report**. The barrier degradation states of the main scenario are described in Section 7.4.3.

### Barrier damage and bentonite properties after a freeze/thaw cycle

The extent of concrete damage after freezing, and its effect on the hydraulic properties of the concrete, is highly dependent on the properties of the concrete before the freezing event. As described in Section 6.5.8, the concrete may freeze if the ground temperature at repository depth drops below  $-3^{\circ}\text{C}$ , affecting the structural integrity of the repository. Within SR-PSU, permafrost is assumed to reach repository depth around 17,500 AD. However, the  $-3^{\circ}\text{C}$  isotherm is not assumed to reach repository depth until 52,000 AD. During the period before this event, the concrete structures will be degraded as described in Section 6.3.8. This leads to the conclusion that freezing does not lead to such dramatic effects on the concrete as described in SAR-08.

The bentonite will retain its properties after a freeze/thaw cycle. This is further clarified in Birgersson and Andersson (2014). The effect of freezing damage on the concrete structure on the properties of the bentonite in the silo has not been assessed in SR-PSU. Since the silo is more or less completely filled with concrete and grout, its volume is not expected to change as an effect of freezing damage. The physical structure of the bentonite can therefore be assumed to be intact even after a mechanical degradation of the concrete structure.

## D3.9 Evolution of chemical conditions in SFR-1

### D3.9.1 SKB’s account

The chemical evolution in SFR includes changes in the surrounding groundwater chemistry as well as changes caused by reactions involving cement and bentonite. The groundwater composition is monitored at SFR-1 in accordance with instructions in the monitoring programme for the facility.

Measurable changes in groundwater chemistry are expected to be very small, but the extension of the time period to 100,000 years leads to future hypothetical changes in groundwater chemistry caused by major climate change. The greatest effect on the repository, according to SKB's account, is the influx of highly dilute groundwaters according to SKB's Weichselian variant, which after 60,000 years could erode the bentonite around the silo. Periods during which the repository is beneath the seabed lead to higher salinity, while salinity will decrease during extended temperate periods due to dilution by precipitation.

The chemical conditions in the repository are strongly reducing, mainly due to the presence of corroding rebar and scrap iron. There is also a natural capacity to maintain reducing conditions due to the presence of Fe(II) minerals in the bedrock. After ten thousand years, however, it is likely that all iron in the waste will have been consumed. Nevertheless, SKB expects that degradation of smectite and dissolution of corrosion products (presumably magnetite) will continue to ensure that conditions in the repository will be, if not strongly reducing, at least anoxic. In connection with a future glaciation phase, however, SKB does not rule out the possibility of oxidising conditions at repository depth.

The cement structures and the waste matrix in SFR-1 contribute to maintaining alkaline pH conditions in and around the repository throughout the period. However, a considerable reduction in pH may occur after several thousand years in the outermost parts of the concrete and in the BTF repositories with relatively little cement. This would lead to some reduction in radionuclide retardation.

Another important chemical parameter is the development of concentrations of complexing agents in the final repository. Since the degradation of cellulose is a slow process, the degradation product and complexing agent ISA (isosaccharinic acid) may remain in the repository environment for a very long time. SKB states that they have taken into account moderate concentrations of ISA in their choice of sorption data. SKB expects that the concentrations of complexing agents will be kept down by sorption to cement and precipitation of their calcium salts.

### **D3.9.2 SSM's assessment of SKB's account in SAR-08**

SKB's conclusions regarding the chemical evolution of the repository are credible and based for the most part on well-established science. However, SSM finds that the following supplementary knowledge and further efforts are urgently needed:

- Study of whether redox-sensitive nuclides such as technetium-99 could make a large dose contribution after depletion of the repository's redox-buffering capacity. As expressed in SAR-08, SKB expects a transformation from strongly reducing to anoxic conditions in the repository after the iron has corroded. However, there is no more detailed analysis of the involved chemical processes that shows that they have sufficient capacity and availability to prevent the occurrence of oxidising conditions in the repository. Nor is there any adjustment or even discussion of the impact on sorption data for redox-sensitive nuclides. SSM can therefore not exclude the possibility that oxidising conditions may arise in the repository. This could possibly lead to dose effects in the form of a rapid leakage of long-lived redox-sensitive nuclides such as technetium-99.

In addition to this other urgent need, efforts in the following areas may be needed in the longer term, such as in connection with the updating of future safety assessments:

- In-depth studies of how the bentonite barrier is affected by dilute groundwater. SR-Can showed that the near-coastal Forsmark area is affected by long periods of temperate conditions due to land uplift and infiltration of precipitation water. This gradually leads to more dilute groundwaters, and SSM therefore finds that SKB needs to model the evolution of ionic strength and determine whether there is a risk that the bentonite surrounding the silo may be affected by such waters. Such a study should be based on updated knowledge from ongoing SKB projects regarding which groundwaters can potentially affect bentonite stability.
- Updating of databases for retention parameters with regard to new data from both international work and work in SKB's own programme. SSM's consultants Zhou et al. (2009) have certain objections to SKB's choice of parameters (e.g. penetration depth in the geosphere and  $K_d$  values for technetium(IV), neptunium(IV) and plutonium(IV) for bentonite and sand/bentonite). Even though the calculated dose and risk contribution from these nuclides is marginal, databases for all reasonably relevant nuclides should be updated with regard to new knowledge.

## Handling in SR-PSU

### Impact of changed redox conditions

SSM pointed out that changes in the redox conditions at repository depth may render in a large dose contribution as the repository's redox buffering capacity is depleted. To determine the impact of changed redox conditions in SFR, SKB has modelled the probable redox development in SFR 1 after closure (Duro et al. 2012). Based on the modelling, the consequences of future oxidising conditions has been assessed. Furthermore, consequences of oxidising conditions, e.g. changed speciation of redox-sensitive nuclides, are assessed (SKBdoc 1430701) as part of SKB's response to SSM prescription concerning the risk and consequences of changing redox conditions at repository depth (SSM 2010).

### Impact of dilute groundwater on bentonite barriers

SSM pointed out that they want SKB to perform detailed studies of how bentonite is affected by dilute groundwater. The dispersion behaviour of montmorillonite is strongly dependent on the valence and concentration of the ions in the porespace. Dispersion (formation of a clay sol) from aggregated clay (clay gel) is mainly relevant in the presence of dilute groundwaters, and especially at low concentrations of divalent groundwater cations (Ca, Mg). For the parameter space of simple mono- and divalent cations (with a monovalent counter-anion), Birgersson et al. (2009) outlined the compositional field where the formation of clay dispersions is possible. They identify two limiting conditions for avoiding the formation of a clay sol:

- The ionic strength of the external solution needs to be  $\geq 25$  mM.
- The fraction of the divalent ion in the clay needs to be  $\geq 90\%$ .

This relation can be compared with the cation concentrations generally expected in contact with fresh or degraded hydrated cement, or more specifically, with the values calculated by Gaucher et al. (2005). Even for the longest timeframe considered (up to 100,000 years), they predict sufficiently high Ca concentrations at the bentonite-shotcrete interface to avoid the dispersion of clay to form a sol. This strongly indicates that the process is not relevant for the design used in case of the silo.

### Database for retention parameters

SSM is asking for an update of the databases concerning retention parameters with respect to new data both from the international work and the work that has been carried out within SKB's own programme. As part of the SR-PSU application, a data report (**Data report**) is submitted, in which the distribution constants ( $K_d$ ) are reviewed and updated where deemed necessary. Information has been extracted from both international studies and from SKB's own programmes. The used  $K_d$  values are listed in Chapter 7 and 8 of the **Data report**. Parameters that could influence the  $K_d$  is further described in Section 6.3.7, and a scenario with increased concentrations of complexing agents is handled as a less probable scenario, see Section 7.5.4. Loss of retention is handled as a residual scenario, see Section 7.7.1.

### Other improvements since SAR-08

Since the SAR-08 assessment, SKB has continued its efforts to understand how and to what extent organic complexing agents can affect the SFR safety functions. As part of SR-PSU, SKB has updated the concentrations of complexing agents in both SFR 1 and 3 (Keith-Roach et al. 2014). New findings concerning the degradation rate of cellulose are used in the SR-PSU (Glaus and Van Loon 2008). SKB has also banned the use of larger amounts of strong organic complexing at the NPP until the knowledge of their properties upon sorption on relevant RN has been further investigated.

## D3.10 Effects of earthquakes on SFR-1

### D3.10.1 SKB's account

In SAR-08, SKB created for the first time a special scenario for the impact of an earthquake on SFR 1. This scenario assumes that a major earthquake can damage engineered barriers (cement and bentonite), leading to a more rapid outward transport of radionuclides via the groundwater flow (only BMA and the silo are considered, since relevant safety functions are of much less importance for other repository parts). SKB assumes that only earthquakes with a magnitude greater than 5 within a radius of 10 km will damage the repository. This assumption is based on the fact that existing

underground tunnels normally remain intact at surface accelerations lower than 0.2 g (a combination of Richter magnitude and distance give a measure of surface acceleration; Bäckblom and Munier 2002). The risk contribution from the earthquake scenario is based on a processing of relevant statistics for earthquakes in combination with an assumption that once an earthquake occurs, radionuclide transport out of the repository is relatively rapid. Certain conservative assumptions have been utilised in the calculation of risk, such as that the entire radionuclide inventory is made accessible for rapid outward transport (in reality an earthquake might only affect parts of the repository), and that sorption and transport resistance in the are not credited in this scenario. SKB does not take into account earthquakes in connection with future ice ages, since the glaciation alone is assumed to damage the engineered barriers in a similar manner.

### **D3.10.2 SSM's assessment of SKB's account in SAR-08**

SSM is of the opinion that the development of a special earthquake scenario lends increased credence to the completeness of the safety assessment. SSM believes that SKB's hypothesis – that the entire repository degrades as a consequence of an earthquake of sufficient magnitude – is fundamentally a conservative approach. However, SKB may eventually need to make certain improvements, for example because no assessment has been made of the repository's resistance to tremors and quakes in the rock. While the comparison with existing underground facilities (Bäckblom and Munier 2002) provides a valuable indication, it cannot be regarded as fully reliable, since it is difficult to judge exactly how comparable these facilities are to SFR. SKB may also need to consider the fact that the repository's resistance during a period of several thousand years may be reduced due to the ageing processes which SKB has previously studied (cement degradation, bentonite alteration etc).

### **Handling in SR-PSU**

Within the framework of SR-PSU, SKB has conducted a stability study of the silo and its resistance to quakes and tremors (Georgiev 2013). Conservative assumptions have been made with respect to water saturation, which is expected to provide a damping effect on tremors and has therefore not been taken into account. The modelling assumptions in this study gave a relatively simple "base case", with the possibility to add factors in further model development. Because of this simple base case, the stability analysis was able to apply the same "stress level" as previously applied on power plants above ground situated on granitic bedrock (SKI 1992b). Hence, in this study, a response spectrum (i.e. measured frequencies associated with earthquakes of different magnitudes) has been applied to this relatively near-surface underground repository, in a similar fashion. The probabilities of earthquakes of different magnitudes to occur are, however, the same as in previous safety assessments (no new scientific information has come to light), see Section 7.6.5. Calculation cases concerning the effect of an earthquake are performed in a similar manner as in previous safety assessments, i.e. with rapid outward transport of the radionuclides from the repository (**Radionuclide transport report**), and with a risk calculated by using a cumulative approach on the probability that an earthquake event will occur within the assessment period (Section 9.3.5 in the **Radionuclide transport report**).

## **D3.11 Consequence calculations**

### **D3.11.1 Modelling of the final repository**

#### *SKB's account*

SKB uses the same compartment model for the near-field (NUCFLOW) in SAR-08 as was used in the preceding consequence analysis, FSR 2001. This time the model is implemented in AMBER. The model takes in account processes such as advection, diffusion, sorption and radioactive decay. A large number of discretisations for each of the repository parts (silo, BMA, 1BTF, 2BTF, BLA) have been selected to represent the waste, engineered barriers, etc.

A great deal of effort has been devoted to reproducing the results from NUCFLOW using AMBER. Aside from certain deficiencies discovered in the implementation of the near-field model in NUCFLOW, AMBER can in principle reproduce the results (Thomson et al. 2008a).

The AMBER code can handle time-dependent transport with incremental changes and multiple transport pathways for the nuclides. Two types of modelling have been carried out in SAR 08. Deterministic modelling has been done with the use of parameters assumed as best estimated value, while probabilistic modelling has been done with the use of parameters samples using the Latin Hypercube Sampling method.

#### *SSM's assessment of SKB's account in SAR-08*

SSM considers it positive that SKB has managed to reproduce the results of the near-field model NUCFLOW using AMBER (Thomson et al. 2008a). At the same time, even though the near-zone models have been implemented in AMBER instead of NUCFLOW, SSM finds that several comments from previous reviews remain unaddressed. Modelling and documentation for the near-field have not been fully updated in SAR-08. This applies for example to the documentation of the model in existing reports, whose deficiencies have made it more difficult for SSM to review and reproduce SKB's calculations of near-field transport.

An important example concerns the description and justification of the detailed design/discretisation of the calculation models for each repository part. The absence of a discussion regarding the design of the model makes it difficult to judge how important different elements in the model are, how they affect other elements in the repository and whether there are alternative assumptions that need to be considered, see also Zhou et al. 2009. SSM would like to know the reasons for the design of the model, and particularly the choice of discretisation. The radionuclide transport report (Thomson et al. 2008b) only presents the results of the modelling. SSM is of the opinion that modelling of radionuclide transport in the safety assessment should be designed so that, besides giving results for the risk analysis, it also provides insight into the safety-related importance of different repository functions. An example of an issue that is inadequately addressed in Thomson et al. (2008b) is discretisation of the outermost barrier (see Zhou et al. 2009).

Another example concerns the description of groundwater flow. While the magnitude of the flow is given in the calculation report (Thomson et al. 2008b), there is no description of how the flow is distributed between different paths and how the direction changes over time. This has to some extent hindered the execution of SSM's independent verification calculations. This is one possible reason for the differences between SKB's results and the results of the calculations performed by SSM's consultants.

SSM is of the opinion that SKB needs to update the near-field modelling and associated documentation for future updates of the safety analysis report.

In SAR-08, SKB has included probabilistic calculations for the near-field and the geosphere. However, it is not clear from the report whether, and if so how, the probabilistic calculations have taken into account the correlation between parameters, which may be of importance for the results of the calculations, see also Section D3.7.2. SSM believes that this part of the analysis needs to be clarified.

## **Handling in SR-PSU**

### **Discretisation of the barriers**

In SR-PSU, SKB has performed simulations with models with different degrees of discretisation in order to illustrate the effect of discretisation of the barriers.

The discretisation of barriers with intact concrete has been tested with a range of models, with number of compartments in the outer barriers ranging from 1–10. The 1BMA model was used for this test (Appendix B in the **Radionuclide transport report**). As a result of this test it was concluded that using 5 compartments in the outer barriers for all models with concrete barriers, i.e. silo, 1–2 BMA and 1–2 BTF, was suitable.

It has also been considered that a discretised compartment model may potentially underestimate the outflow during conditions with severely degraded concrete, that is assumed to develop in the later part of the assessment period. To evaluate this, a comparison has been done between different compartment models, including a more realistic model for fractured concrete (Appendix D in the **Radionuclide transport report**). As a result of this investigation, the modelling approach was to



model the advective transport through the barriers as a direct transport through the barriers during periods with severely degraded concrete, without taking into account sorption in the barriers. This approach was used for the 1–2 BMA models.

### **Groundwater flow**

In SR-PSU, SKB has updated the hydrological modelling (Oden et al. 2014). A detailed modelling of the hydrology on the repository scale has been performed (Abarca et al. 2013). The flow through different parts of the repository has been calculated at the level of detail corresponding to the discretisation of the radionuclide transport model. The connection between the hydrological model and radionuclide transport model in the near-field is explained in Section 9.2 of the **Radionuclide transport report**.

## **D3.11.2 Modelling of the geosphere**

### *SKB's account*

The FARF31 model (Norman and Kjellbert 1990) is used, as in FSR 2001, for radionuclide transport in the geosphere. The model takes into account processes such as advection, dispersion, matrix diffusion, sorption and chain decay. This model is also implemented in AMBER, which has been used to solve partial differential equations for radionuclide transport in the geosphere.

The transport model is represented in AMBER in two dimensions consisting of 40 compartments that are used to represent transport processes such as advection and dispersion in the fracture direction and 7 compartments to represent transport processes such as matrix diffusion and sorption in the direction of the rock matrix. To increase the efficiency of the calculations, they were carried out with a reduced number of matrix elements in the main transport direction. Thomson et al. (2008a) also present a comparison between previous modelling done in FARF 31 and the compartment model in AMBER and show good agreement when it comes to non-sorbing and weakly sorbing nuclides. The results differ to some extent for strongly sorbing nuclides.

SKB notes that an important property of the AMBER model is that it can represent a geosphere that changes with time in order to take into account the fact that the transport length increases with time when the transport direction in the geosphere changes from vertical to horizontal due to land uplift. This has been handled in such a way that the length of each compartment in the AMBER model increases with time. The change occurs incrementally.

### *SSM's assessment of SKB's account in SAR-08*

SSM takes a positive view of the fact that SKB has taken the regulatory authorities' review comments regarding FSR 2001 into account and that SKB includes radionuclide transport in the geosphere in SAR 08.

SSM has no objections to SKB's use of a compartment model to solve differential equations for radionuclide transport in the geosphere. However, as in the case of the near-field modelling, SSM finds that SKB needs to improve the documentation and justification of the model used for future assessments.

For example, SSM believes that SKB may need to carry out a more extensive analysis of the importance of the discretisation of the compartment model in both directions, i.e. for transport both along the fracture and in the rock matrix. According to previous experience (Broed and Xu 2008), the number of compartments can affect the results for different radionuclides. The results of the analyses that have been done for the purpose of improving the efficiency of the calculations are therefore not convincing, since the solutions do not converge according to when the discretisation increases (figure on page 140 in Thomson et al. 2008b).

Another example concerns gradual changes in the premises for transport in the geosphere. SSM is of the opinion that SKB's assumption that the change from vertical to horizontal transport can be represented by transforming a vertical compartment to a horizontal one cannot with certainty be considered conservative. Even though the size of the expected release is greater, the increased horizontal flow leads to an earlier discharge to the receiving compartment. A later but more limited release could possibly give a higher dose, since the release takes place to a lake instead of to the Baltic Sea, which provides a large dilution effect.

But the Authority makes the judgement that updating of the model and its documentation with respect to these deficiencies can wait until future analyses, based on e.g. the independent modelling carried out by Zhou et al. (2009). SSM's consultants use a FARF 31-like model with SKB's near-field releases as input data. The results of random sampling by the consultants agree fairly well with SKB's, with only small differences. These could possibly be explained by differences between SKB's and the SSM consultants' discretisation methods.

A special question concerns accumulation of radionuclides in sediments, which among other things is dependent on the modelling of radionuclide transport through the geosphere. SKB figures on only one discharge point instead of two, which, based on SKB's analysis of the hydrology in the area, should be a more realistic assumption. This can also lead to underestimation of the consequences, since the vertical geosphere release through the coast period can, according to SSM, lead to accumulation of radionuclides in sediments. Such accumulation may entail that radionuclides become available at a later stage in cultivable soil in the agriculture model. This issue is also linked to SKB's biosphere analysis, which is commented on in Section D3.11.2.

Finally, SSM is of the opinion that the matrix depth of 2 m that is used in SAR-08 is not a conservative assumption, nor is it consistent with the SR-Can safety assessment. In SR-Can, a value of 0.03 m is used for matrix depth in deterministic calculations (Hedin 2007).

SSM believes that SKB has an unsatisfactory explanation of its choice of parameter in this matter and that this needs to be improved for future reports. At the same time, SSM notes that this matter is probably of minor consequence for calculated risk.

## Handling in SR-PSU

### Discretisation of the compartment model

In SR-PSU, SKB uses a compartment model that is based on the same conceptual model as FARF31. The discretisation of the model has been evaluated and, as a result, the number of compartments, both along the fracture and in the matrix, have been expanded. The modelling tool that is now being used has also been optimised to run models with more compartments, since the possibly deficient discretisation used in SAR-08 was in part the result of a compromise between numerical accuracy and simulation time (**Radionuclide transport report**).

### Gradual changes in transport premises

The modelling approach currently used by SKB permits flow parameters in the geosphere to be changed gradually by interpolation between the values for discrete points in time calculated in the hydromodelling. In this way, the gradual change during land uplift can be modelled in a more realistic way (Odén et al. 2014).

### Accumulation of radionuclides in sediment

As noted in Section D3.6 above, the coupled modelling approach used by SKB in SR-PSU enables accumulation of radionuclides in sediment to be modelled in a more realistic manner.

### Matrix depth

It should be noted that the matrix depth represents a theoretical maximum depth for diffusion of radionuclides: (half) the mean distance between water-bearing fractures in the rock. Hence, it does not represent the actual penetration depth for most radionuclides. The penetration depth is, for most radionuclides, limited by sorption and the radionuclide's half-life (**Radionuclide transport report**).

## D3.11.3 Modelling of radionuclide flux in the biosphere

### *SKB's account*

For calculation of radionuclide migration and flux in the biosphere, SKB uses landscape models developed in connection with the SR-Can safety assessment. Landscape models take into account the evolution of the ecosystems due to land uplift and transport between different ecosystems in the model area. A new carbon-14 model for both terrestrial and aquatic environment has been developed and used in SAR 08. Ecosystem models are in principle the same as those used in the FSR 2001 safety assessment (Karlsson et al. 2001), with few modifications.

The modelling approach is similar to that used in SR-Can, but instead of a landscape dose factor (LDF) for whole landscapes and for the whole modelling period, a dose factor (DF) is presented for three different landscape configurations. SKB models these three landscapes separately, and the calculation period for each landscape configuration is 20,000 years. The transition between the different landscape configurations is not dynamic. SKB notes that it is always the biosphere object that first receives releases that give the highest dose to the most exposed group.

#### *SSM's assessment of SKB's account in SAR-08*

SSM takes a positive view of the fact that SKB has responded to the regulatory authorities' earlier review comments, for example by using a landscape model that takes migration of radionuclides between different ecosystems into account and permits an evaluation of parallel exposure pathways.

SSM has identified a number of deficiencies in SKB's biosphere modelling that could affect the calculation results. SSM shares the opinion of Klos and Shaw (2009) that SKB should revise the assumptions on which the dose calculations are based to determine the degree of conservatism in the estimated risk. It is particularly urgent for SKB to re-examine questions associated with SKB's choice of the size of biosphere objects (see Xu et al. 2008), uncertainties concerning the size of catchments, the handling of accumulation and representation of certain retention processes, for example:

- *SKB's modelling does not explicitly evaluate the importance of the transition from one landscape model to another.* SSM judges that the approach is too stylized. On the one hand, the approach is conservative considering that the calculation period for DF for each landscape configuration is 20,000 years, which is considerably longer than the expected period the landscape configuration is intended to represent (roughly a few thousand years). But on the other hand, accumulation of radionuclides from one configuration to the next has not been taken into account. This is deemed to be particularly significant for the biosphere evolution that takes place as a result of the ongoing process of land uplift, for example:
  - Regarding the transition from lake to mire, factors are given in Appendix E of the technical background report (Bergström et al. 2008) to take into account accumulation in lake sediments. These factors are, however, not used by SKB in the assessment with the explanation that the releases during the period in question are dominated by carbon-14. SSM shares the judgement that this process will probably not affect the maximum calculated dose, but considers that SKB should, in future assessments, in a better way include the importance of accumulation in the determination of DFs.
  - Regarding the transition from mireland to agricultural land, DFs for agricultural land are calculated based on the activity concentration in the mireland. SSM is of the opinion that SKB needs to clarify that this is a conservative approach.
  - Finally, SSM finds that SKB should have evaluated the importance of the fact that the discharge point is gradually moved due to land uplift. The importance of accumulation of the releases that take place during the initial millennia should in principle have been included as a parallel exposure pathway in the evaluation of DFs for the lake period. In this case as well, SSM makes the judgement that this would not affect the maximum calculated doses, but nevertheless considers that it should be addressed in future assessments.
- *An evaluation of the importance of the size of the contaminated area and the size of the catchment is lacking.*
  - SSM takes a positive view of the fact that SKB has carried out an uncertainty and sensitivity analysis, but finds that certain important parameters are lacking in the evaluation of e.g. the water residence time in aquatic biosphere objects, e.g. the size of the catchment, which is of great importance. This will in turn affect the activity concentration in the environment and thereby the calculated dose. In its own study, SKB has evaluated different models that estimate the size of the catchment and the water residence time for 24 lakes in the Forsmark area (Järsjö et al. 2007). The results differ by a factor of 5 compared with SKB's previous study (Brunberg et al. 2004). SSM is of the opinion that SKB needs to take this uncertainty into account in future assessments.
  - In conjunction with the regulatory review of SR-Can, the authorities' independent modelling shows that the influx of radionuclides to the biosphere can take place to geographically more limited areas (Xu et al. 2008). SKB's own modelling study has shown similar results (Holmén and Stigsson 2001, p. 234). The estimated size of the contaminated area according

to Xu et al. (2008) and Holmén and Stigsson (2001) is an order of magnitude or so smaller, which could lead to a corresponding increase in the radiation doses. However, this is true provided that the contaminated area is large enough to support the group of humans to be protected. SSM therefore finds that SKB needs to evaluate the importance of the uncertainties in this matter in future assessments.

SSM shares the viewpoints of the consultants (Klos and Shaw 2009) that the model description for the new carbon-14 model constructed by SKB (Avila and Pröhl 2008) is clear and that the model may be a reasonable starting point to use in a safety assessment. However, SSM's consultants assert that the connection between the analysis of FEPs (features, events and processes) and the description of the biosphere model is not transparent.

A model comparison is being done within BIOPROTA's carbon-14 project (BIOPROTA is an international forum for biosphere modelling). SKB's new carbon-14-model for terrestrial environment is included in the model comparison. SSM believes that SKB should further pursue this work and that SKB may need to undertake further efforts in this area since it can greatly influence the calculated doses for releases of carbon-14 after the lake period, i.e. from 7,000 years and onward.

## Handling in SR-PSU

### Landscape development – transitions from one landscape model to another

- In SR-PSU, the transition from one landscape to another is modelled as a continuum. This means that several ecosystems can exist simultaneously in a specific object, and that the relative importance of each ecosystem will change gradually according to shoreline regression and vegetation ingrowth in lakes. Organic matter accumulated during the aquatic stage is in the model retained when a lake is transformed to a terrestrial area. Accordingly, any radionuclides released into an object can be retained during the succession from one ecosystem to another. As soon as a biosphere object (i.e. an area where radionuclides from the repository may reach the biosphere) due to the shoreline regression has reach an altitude high enough to not be flooded by sea water (defined as 1 m above sea level), it is assumed that the object may be ditched and used for agriculture. In the modelling it is assumed that ditching and land reclamation of an object may start in each modelled time step. Accordingly, in the dose modelling, both the natural ecosystem with its accumulated radionuclides, and the newly cultivated object with the same amount of accumulated radionuclides, is evaluated in each time step.
- In the dose modelling, doses from agricultural land is not calculated directly from the radionuclide concentrations in wetland. When cultivated, wetland peat is compacted, and in cases when the compacted peat layer is less than 50 cm, the underlying soil up to 50 cm total depth is added to calculate radionuclide concentration in agricultural soil (for a detailed description, see Chapter 7 in Saetre et al. (2013).
- Analysis of discharge areas in SR-PSU shows that the major part of the discharge during the marine stage is located to the central parts of basin 157. During the following terrestrial stage, discharge is further concentrated into the biosphere object 157\_2. In order to avoid underestimation of the potential dose from object 157\_2, it is therefore assumed that all discharge into basin 157 during the whole analysed period will be located in object 157\_2. For evaluation of the importance of radionuclide release into other areas, a calculation case with the release distributed over the landscape has been included in the uncertainty analysis for the biosphere (**Biosphere synthesis report**).

### Importance of size of biosphere objects and size of catchments

In SR-PSU, the effects on activity concentrations of alternative delineations were analysed for the biosphere object where the major part of the discharge from the repository is located (object 157\_2). For further details, see Sections 7.4.7 and 10.7 in the **Biosphere synthesis report**.

### Transparence in the relation between the FEP analysis and the development of the biosphere model

- The coupling between the FEP analysis for the biosphere and the biosphere modelling in SR-PSU is described in SKB (2014b).

### Further work concerning C-14 modelling

- SKB participate actively in the C-14-related work performed within Bioprota. In SR-PSU, the model for atmospheric dispersion of C-14 has been updated, together with some other aspects of C-14 modelling. The radionuclide model is described in Saetre et al. (2013), and the handling of C-14 in the modelling is further described in SKB (2014b).

### D3.11.4 Methods for calculation of environmental effects

#### *SKB's account*

SKB uses the ERICA tool, which has been developed within the framework of the ERICA project in the EU's sixth framework programme for estimating effects on the environment. A risk estimation in three tiers is done in the ERICA tool. Tier 1 is based on risk quotients (RQs) where specified activity concentrations for radionuclides in soil, water and sediment (Environmental Media Concentration Limits, EMCLs) are compared with maximum measured or modelled activity concentrations in the area in question. SKB presents risk quotients for coastal water, lake water and soil argues for why risk quotients for sea and lake sediments are not needed. The calculated RQs for all radionuclides are well below 1, and the sum of the quotients is also less than 1. SKB notes that the effect on the environment due to any releases is negligible. The analysis can therefore be limited to the first tier (tier 1).

#### *SSM's assessment of SKB's account in SAR-08*

SSM takes a positive view of the fact that SKB analyses effects on the environment, in compliance with the regulation (SSMFS 2008:37). SSM believes that the ERICA tool can be used to estimate effects on the environment. There are, however, certain ambiguities, as described below.

As SSM observes in Section D3.11.1, SKB does not take into account the transfer of accumulated radionuclides from an earlier ecosystem to a later ecosystem in the assessment, which can lead to underestimation of the concentrations. The size of the contaminated area may also be smaller than the chosen model area, which can affect the activity concentrations. At the same time, SSM can conclude that the calculated concentrations fall short of the level where more in-depth analyses are needed by such a good margin that SKB's account is acceptable. However, SKB should further develop this part of the analysis in preparation for future safety assessments.

### Handling in SR-PSU

By using a model where the transition from one landscape to another is modelled as a continuum (see Section D3.11.3 above), any radionuclides accumulated in an object are retained during the landscape succession. Further, the effects of size of the contaminated area on activity concentrations have been evaluated in additional calculations by analysing alternative delineations of an object (see Section D3.11.3 above). SKB has also developed the analysis of potential influence of the SFR repository on the environment, for example by using site specific data on species occurrences, habitat use and CR-values (Jaeschke et al. 2013, **Biosphere synthesis report**).

### D3.11.5 Presentation of calculation results

#### *SKB's account*

SKB presents the dose consequences separately for releases from the different parts of the repository (silo, BMA, 1BTF, 2BTF, BLA), for the different scenarios and the different calculation cases. For the main scenario with the Weichselian variant, the dose contribution for the different radionuclides is also presented separately for each repository part.

Releases of radionuclides from the near-field (Bq/year) rise sharply after resaturation of the final repository and reach a maximum a short time thereafter in all cases. The releases then decline gradually due to leaching and decay. However, the radiation doses are virtually negligible during the initial period of 2,000 years when the Baltic Sea is still the receiving body of water. The doses increase markedly when other exposure pathways become possible after this period. The increase after the Baltic Sea period is due to reduced dilution when a lake becomes the primary receiving body. In some cases, a further increase is obtained when the lake disappears and is replaced by a mire/forest. The highest doses are generally obtained from usage of a well near the final repository.

The calculations show that carbon-14 is the dominant nuclide by far in most cases in terms of maximum doses and outflows. The organic fraction that does not sorb generally gives the greatest contribution, but inorganic carbon-14 can also make considerable contributions. In the case of release to a mireland, cesium-135 dominates, and in the case of consumption of well water in the discharge area, nickel-59, selenium-79, iodine-129 and molybdenum-93 also make significant contributions to the calculated dose. In the calculation case “intrusion well in BLA”, transuranics also make some dose contribution.

The maximum doses for the main scenario with the Weichselian variant are around 0.01 mSv/year. The doses due to consumption of drinking water from a well in the discharge area vary between the different repository parts. Compared with the doses due to releases to the environment, the doses from this exposure pathway are lower for the silo and BMA, slightly higher for the BTF repositories and much higher for BLA. The releases from BTF and BLA do not affect the total dose, however, which is dominated by releases from BMA and the silo.

In the case of the main scenario with the Greenhouse Variant, the calculated maximum doses do not differ significantly from the Weichselian variant. The doses are dominated by releases from BMA during the entire analysed period, except when the releases take place to a lake, during which time releases from the silo also make a significant contribution.

Other “less probable scenarios” do not have any significant impact on the calculated dose, with the exception of exposure via consumption of water from a well drilled directly into the different repository parts, when the doses amount at most to 10 mSv/year. These doses from intrusion do not need to be included in the risk evaluation in accordance with SSMFS 2008:37.

In the case of the “residual scenarios” that are presented, doses are calculated in the interval between 0.01 and 0.3 mSv/year, where the highest doses stem from the case with early degradation of barriers and are dominated by releases from BMA.

#### *SSM's assessment of SKB's account in SAR-08*

SSM notes that the doses that are reported do not differ in any crucial way from the doses that were estimated in FSR 2001. One possible reason is that the analysis of hydrology and modelling in the near-field has not in any true sense been updated for SAR-08.

One factor that greatly affects the calculated doses is the dilution of the releases in the Baltic Sea that occur during the period the repository is situated beneath the surface of the sea. The Baltic Sea is also of crucial importance for preventing intrusion in the repository in an early phase after closure. For certain long-lived nuclides, sorption on concrete and cement is the most critical safety function.

During the inland period, the limited groundwater flow through the disposal rooms is also an important safety function.

After the review of FSR 2001, the regulatory authorities called for a more thorough analysis of what doses may occur in the distant future, i.e. beyond the 10,000 years after closure to which FSR 2001 was limited. SSM can conclude that the calculated doses are highest during the first 10–20,000-year period. The results from the less probable scenarios and the residual scenarios also show that the system is more sensitive to different types of disturbances during the initial post-closure period. For this reason, it is particularly important that the handling of processes that can lead to increased releases during this period is thorough and well-supported.

One particular question relates to SKB's modelling of carbon-14. In the main scenario, this nuclide gives rise to the highest doses by exposure via consumption of fish caught in a lake. Releases of carbon-14 to other recipients, such as mireland and forest, have considerably lower consequences, according to SKB. As is evident from Section D3.11.2, however, the possibility cannot be ruled out that this is due to the way in which SKB models release of carbon-14 to terrestrial environments. Based on the reported data, SSM cannot determine whether this can be expected to affect the highest calculated dose. SSM is of the opinion that SKB needs to deepen these parts of the analysis in future reports.

The dose calculations that are presented demonstrate the sensitivity of the system to an early degradation of the barriers. This is particularly true for the repository part in BMA, and to some

extent for the silo, while a degradation of the barriers in the distant future does not have as great an impact on the maximum doses. SSM is of the opinion that the most urgent supplement of SAR-08 needs to include a thorough analysis of the extent to which relevant degradation processes during the first 10,000 years after closure can affect the barriers' function. As SSM concludes in Section D3.8, some of work still remains to be done in this area, regarding both the importance of climate change and other degradation processes.

SKB's calculations of the importance of a well in the discharge area indicate that the doses are primarily due to the presence of long-lived radionuclides, but that the consequences of drinking water consumption gradually decline, probably due to the fact that the radionuclides are leached out of the repository system.

## Handling in SR-PSU

### Modelling of carbon-14

SKB has developed the handling of C-14 in the radionuclide transport modelling of the surface systems. For example, the discretisation of the regolith has been refined and now includes an organic pool, which enables accumulation of carbon in the model. The modelling of degassing of carbon in mires has been updated, and a new atmosphere model has been developed. Moreover, an updated landscape model results in somewhat changed pattern for where in the landscape C-14 from the repository may potentially be released. The updated landscape model is described in the **Biosphere synthesis report**, whereas topics investigated for model development with regards to C-14 are described in detail in SKB (2014b). The updated radionuclide model for the biosphere is described in Saetre et al. (2013).

### Analysis of barrier degradation processes during the first 10,000 years

Climate and climate-related issues and barrier degradation have been further assessed in SR-PSU and two less probable scenarios have been chosen to evaluate uncertainties in barrier degradation, the *accelerated concrete degradation scenario* and the *bentonite degradation scenario*. The assessment of the climate has focused on determining the potential time of onset of the first period with permafrost in the Forsmark area resulting in the early periglacial climate case that is one of the variants of the main scenario.

New modelling on concrete degradation (Höglund 2014 and Chapter 6) supports the choice of data in both the main scenario and the *accelerated concrete degradation scenario*, see Section 7.6.3. The climatic conditions in both variants of the main scenario (*global warming* and the *early periglacial* variants) imply that freezing of concrete (bedrock temperature of less than  $-3^{\circ}\text{C}$ ) will not occur until 52,000 AD, see Section 6.2.3. Physical/mechanical degradation will occur to such an extent before 52,000 AD that the exact time of freezing is of minor importance.

Additional studies have also been performed to evaluate bentonite degradation. These support both the main scenario and the *bentonite degradation scenario* (Börgesson et al. 2014 and Chapter 6). The *bentonite degradation scenario* (Section 7.6.4) is selected to evaluate uncertainties in the consequences of extensive periglacial conditions in combination with uncertainties in the sealing properties of the bentonite. However, SSM comments are related to degradation during the first 10,000 years and this scenario is assumed to be possible at earliest when the ice-lens formation occurs during the first permafrost period in the *early periglacial climate case*, i.e. in the period from 17,500 to 20,500 AD.

## D3.12 Characterisation of risk

### D3.12.1 SKB's account

SKB's method for estimating the annual risk is presented in Section 10.1.2. From this it is evident that the estimate is based on the arithmetic mean of the probabilistic dose calculations carried out together with probability assessments for the scenarios and the conversion factor of 7.3 percent per sievert. For each scenario, SKB has made an estimate of the risk for the cases without well and with well in the discharge area, and for some scenarios also for an intrusion well in the repository. The aggregate risk for a scenario therefore consists of the risk for the case without well and with the well that gives the highest risk. SKB has compared the calculated risk with the stipulated risk criterion

of  $10^{-6}$  per year (according to Section 6 of SSMFS 2008:37), but has also considered the higher risk criterion of  $10^{-5}$  per year and its applicability in the event of exposure via consumption of drinking water from a well and ingestion of fish during the lake period.

SKB concludes that the calculated doses for the two variants of climate evolution (Weichselian and greenhouse) are the same, due to the fact that the highest dose occurs relatively early during the evolution of the repository, during the period when the climate evolutions do not differ.

The highest risk, approximately  $9 \cdot 10^{-6}$  per year, occurs just after 5,000 AD in a lake ecosystem and is mainly caused by organic carbon-14 from the silo and BMA and by inorganic carbon-14 from 2BTF. The dose contribution from a well in the discharge area is at most about  $15 \mu\text{Sv}/\text{year}$ , which, together with a probability of 0.1, gives a risk contribution of  $10^{-7}$  per year. The equivalent dose contribution from an intrusion well is at most  $1 \text{ mSv}/\text{year}$  (for 2BTF), and with a probability of  $1.5 \times 10^{-3}$  the risk contribution is  $2 \times 10^{-7}$  per year. Since the highest exposure from the wells occurs in 3,000 AD, the contribution to the highest calculated risk is marginal, since it is not estimated to occur until the 5,000 AD.

The effects of an earthquake are analysed by SKB by assuming that the effects on the repository are the same regardless of the size of the earthquake, and taking into account the probability that an earthquake has occurred. In the analysis, SKB assumes that an earthquake with a magnitude of less than 5 will not affect the repository. Based on these assumptions, the highest annual risk is estimated to be  $8 \times 10^{-7}$  per year and to occur in 5,000 AD.

Early freezing of the repository is evaluated in the scenario by means of four calculation cases, of which the calculation case “extreme permafrost” gives rise to the highest dose. This dose is calculated to occur in 39,000 AD and to amount to  $1 \times 10^{-6}$  per year.

Similar arguments are presented regarding the probability that a talik will be formed at the repository (based on the Weichselian variant, but assuming that during periods with permafrost an unfrozen area will remain at the repository where groundwater can flow). Due to the difficulties of specifying a probability for the scenario, a value of one is assigned. However, the calculated doses differ from the main scenario for the period up to 25,000 AD, and the highest dose occurs in 5,000 AD and amounts to  $12 \mu\text{Sv}/\text{year}$ .

The scenario with high concentrations of complexing agents is based on the Weichselian variant but takes into account significantly higher concentrations of complexing agents in the near-field. In the case without a well, the highest dose occurs around 5,000 AD and amounts to  $11 \mu\text{Sv}/\text{year}$ . In the case without a well in the discharge area, the highest dose occurs around 4,000 AD and amounts to  $19 \mu\text{Sv}/\text{year}$ . SKB judges the probability of the scenario to be 0.1, which means that the highest risk is calculated to be  $8 \times 10^{-8}$  per year. In the case of an intrusion well in the repository, the highest dose is just under  $10 \text{ mSv}/\text{year}$  (for 2BTF). The probability of an intrusion well is given as  $1.5 \times 10^{-3}$ , which, along with the probability for the scenario of 0.1, gives a calculated risk of  $9 \times 10^{-8}$  per year.

SKB assesses the scenario with gas-driven advection by taking into account the consequences of the release of radionuclides resulting from expulsion of water due to gas evolution in the silo. Since this gas evolution takes place during the period the repository is submerged, the calculated risk is the same as for the main scenario if a probability of one is assigned to the scenario.

SKB estimates the impact on the repository’s protective capability to which an intrusion well can give rise. SKB refers to the hydrological calculations that were done by Holmén and Stigsson (2001) for FSR 2001. In this study, the impact on the hydrological flow to which an intrusion well can give rise was evaluated, showing that an intrusion well in BLA may affect the flow through BLA by a factor of 3 to 7, compared with the situation without a well.

SKB also presents an estimate of the importance of risk dilution for three individual events: earthquake, well in the discharge area and intrusion well in the repository. For each event, the risk is illustrated by calculating the cumulative probability for different points in time. The risk is calculated by multiplying the calculated probability by the calculated dose consequence of the event and using the dose conversion factor. The calculations show that the risk of the three events increases by roughly an order of magnitude.



SKB presents an argument concerning the credibility of the calculation results and the assumptions that are inherent in the analyses. SKB points to the cautious assumptions that have been made and evaluates the most important uncertainties in the calculations. SKB's overall conclusion from the analysis is that three calculation cases in particular give the highest doses: the main scenario, the earthquake scenario and the scenario with early freezing of the repository. SKB says that the two latter scenarios have been handled in such a way that they overestimate the calculated consequences. For the main scenario as well, SKB asserts that the most important uncertainties have been handled in such a way that it is not likely that a higher risk could occur than the calculated risk.

### **D3.12.2 SSM's assessment of SKB's account in SAR-08**

#### *Presentation and risk methodology*

SSM concludes that SKB's aggregate risk estimate is based on a structured analysis of the different calculation case and scenarios. SSM takes a positive view of the account of the calculated maximum radiation dose and an estimated probability for each calculation case. This facilitates the assessment against the prescribed risk criterion. SSM can also conclude that SKB's analysis of the uncertainties has also been improved. Compared with FSR 2001, the presentation and the arguments for the selection of scenarios and calculation cases have been developed positively. SSM's viewpoints regarding the selected calculation case and scenarios are given below.

The account reflects to some extent the fact that SKB has in certain areas followed the account in FSR 2001. This is particularly noticeable in the areas of near-field modelling and hydromodelling, and some of the previously offered review comments still stand. SSM's difficulties in understanding and being able to reproduce SKB's calculations have some effect on its confidence in the assessment. SSM believes that SKB needs to further develop the assessment and its presentation for future safety analysis reports.

#### *Scenarios and scenario probabilities*

SSM finds that SKB's methods for selection of scenarios have been improved compared with FSR 2001. On a general level, the method essentially follows the structure called for in SSM's regulations, for example regarding how the scenarios are sorted. SKB's integration of different climate evolutions in the main scenario also follows SSM's directions. SKB's arguments concerning the importance of a drinking water well in the discharge area and an intrusion well in the repository are essentially in agreement with SSM's regulations.

An important conclusion of the regulatory authorities' review of FSR 2001 was that the modelling of the gradual degradation of the barriers needed to be improved. Progress has been made in this area, particular in the modelling of the silo. SSM finds that greater uncertainties exist regarding the long-term evolution of the barriers in BMA, where both hydrogeological, geochemical and climate-related factors can have a great influence on the risk analysis. As is evident from the review, SSM finds that SKB's arguments for the fact that the barrier function in BMA does not appreciably deteriorate during a period of more than 40,000 years are not sufficiently convincing. Degradation processes linked to reaction with waste materials and rebar are not analysed in a traceable manner either. SSM finds that a supplementary or more detailed explanation of SKB's analysis and account of barrier degradation is needed. The Authority's greatest difficulty in judging this matter is that SKB's calculations do not show how extensive the degradation processes need to be to have a significant impact on dose/risk. It should in this context be noted that SKB has, by means of further studies, achieved a significantly improved understanding of large-scale chemical changes in the barrier system. All in all, however, the judgement is that SKB has not yet acceptably addressed the deficiency pointed out in Dverstorp et al. (2003). This is mainly of importance for estimated dose/risk for BMA.

According to SKB's analysis, the most critical exposure pathway is consumption of fish from a lake to which releases occur. The calculated radiation doses are dominated by the releases of carbon-14, and the calculated risk is in parity with the prescribed risk criterion. A particularly critical factor is whether processes that can affect the releases, such as barrier degradation, will occur before or after the period during which releases occur to the lake. According to the residual scenario "Failure of barrier function – Early degradation of engineered barriers," the calculated doses increase by a factor of 30 if degradation of the concrete barriers takes place in 5,000 AD, compared to if degradation

occurs after 25,000 AD or later. The big increase is caused mainly by increased releases from BMA. However, SSM cannot rule out the possibility that an update of the biosphere model, and especially the carbon-14 model, could entail higher doses for the time after the lake period. This could mean that the analyses would be less sensitive to when barrier degradation occurs. In order for more definite conclusions to be drawn, the analysis needs to be deepened.

#### *Assessment of uncertainties in the risk analysis*

SSM finds that SKB's calculations primarily provide a clear illustration of which parameters, events and processes are most critical for the risk analysis. Among these are the long-term function of the engineered barriers (especially in BMA), the inventory of certain radionuclides (above all carbon-14, nickel-59 and iodine-129), the groundwater flow in the final repository and recipient conditions in the biosphere.

SSM points in its review to a number of parts of the biosphere modelling that need to be further developed for future safety assessments. These include how the transition between different ecosystems is modelled, how the size of the contaminated area is determined and modelled, the modelling of mireland, and the carbon-14 model for a terrestrial environment. However, in view of the fact that the calculated doses resulting from releases from SFR-1 are dominated by releases of carbon-14 to a lake, the Authority can conclude that most of these uncertainties would not affect the maximum calculated dose, but rather the doses that are expected to occur after the lake period.

It is difficult for SSM to judge whether the uncertainties in the flow modelling are reflected to a sufficient degree in these results. As described in the above review comments, SSM would like to see more detailed arguments for the assumed parameter distributions and a well-founded discussion of which model variants can be rejected. SKB could respond to these questions by supplementing the calculations with relevant information and discussions based on available material. However, this presumes that the calculations performed reasonably reflect the remaining uncertainties to a sufficient degree.

SSM's review of SKB's account of the inventory of radionuclides has been impaired by the structure of the account presented. For future reports, the structure should therefore be revised in keeping with the viewpoints that have been offered. Nevertheless, the estimate is judged, with a few exceptions, to provide an acceptable basis for the safety assessment. Important remaining questions primarily concern the applied method of distributing carbon-14 between BMA and the silo and the inventory of carbon-14 in waste delivered from Studsvik. SSM does not rule out the possibility that the concentrations in BMA, BTF and BLA may be underestimated. Better data on the carbon-14 concentration in the waste is expected to be obtained from the waste analyses that have been initiated in response to previous regulatory decisions. The method of estimating the concentration of plutonium and other transuranics in the different repository parts also needs to be revised.

#### *Conclusions for long-term function*

SSM is of the opinion that SKB's account in SAR 2008 provides a better, and in most respects adequate, basis for evaluating fulfilment of SSM's risk criterion, compared with FSR 2001. SKB has argued in a better way than before for its selection of scenarios and scenario probabilities, and the dose and risk calculations that are presented are judged to be credible for the most part. The biggest difficulty in determining whether SSM's risk criterion is fulfilled is judged to be linked to certain assumptions and parameter values in the modelling. SKB's analyses indicate that the greatest consequences and uncertainties in repository evolution are associated with BMA. In its review, SSM has pointed out uncertainties regarding e.g. barrier degradation, which makes it difficult to judge whether the calculated releases of radionuclides from this repository part are conservatively handled. In view of the fact that the calculated risk is on a level with the prescribed risk criterion, SSM believes that SKB needs to provide certain clarifying supplementary information before a final judgement can be made on SAR-08.

## Handling in SR-PSU

### Scenarios and scenario probabilities

#### *Barrier degradation:*

See SKBs response in Sections D3.5.2 and D3.11.5 above.

### Assessment of uncertainties in the risk analysis

#### *Biosphere modelling:*

See SKBs response in Section D3.11.3 above concerning the SSM comments on transition between ecosystems, how the size of the contaminated area is determined, and the carbon-14 model. An evaluation of uncertainty in the biosphere modelling in SR-PSU is summarised in Section 11.2 in the **Biosphere synthesis report**.

#### *Flow modelling:*

See SKBs response in Section D3.7.3 above for a discussion on the chosen parameter values and model variants.

#### *Inventory:*

See SKBs response in Section D3.5.2 above.

## D3.13 SSM's summary assessment

SSM has reviewed the account and judges that it satisfies, with one exception, the Authority's requirements regarding long-term radiation protection and safety for the repository parts BLA, 1BTF, 2BTF and silo. The calculation cases and scenarios that are derived and analysed are structured in a manner that satisfies the Authority's requirements and complies in essence with the directions issued by the Authority. This facilitates assessment against the prescribed risk criterion that applies to the long-term consequences of the final disposal of nuclear waste. The results of the dose and risk calculations that are presented are deemed to be credible for the most part. A remaining deficiency from the 2001 report is, however, the lack of a concrete and coherent account of the planned measures in conjunction with repository closure.

In the review, the Authority indicates a number of other questions which SKB needs to take into account in preparing future reports. Of these, SSM would particularly like to highlight certain remaining questions regarding degradation of the cement barriers which are of relevance to the repository parts 1BTF, 2BTF, BMA and silo (BLA has no cement barriers). However, SSM judges that this question could mainly have an impact on the calculated long-term releases from BMA. As regards BTF and the silo, these are not of such importance that they affect the overall assessment of the repository's long-term safety. The silo is designed with an additional barrier function in the bentonite clay. A much more conservative hypothesis is used for cement degradation in the case of BTF compared with BMA. In its review, SSM has also identified questions concerning hydromodelling, hydrogeochemical modelling and biosphere modelling which SKB needs to explore further prior to future reports. However, SSM judges that as regards the repository parts BLA, 1BTF, 2BTF and silo, these questions should not significantly alter the overall assessment regarding the long-term safety of the repository. Further clarifications are needed from SKB to verify this judgement.

When it comes to BMA, SSM deems that supplementary information is needed before SSM can make a final judgement regarding compliance with requirements. The Authority deems that several of the assumptions and parameter choices applied in the assessment are insufficiently substantiated. This applies in particular to ambiguities regarding the expected evolution of the engineered barriers in the repository part BMA. In view of the importance of this repository part with regard to the long-term environmental consequences, ambiguities regarding the hydrological and hydrogeochemical questions should probably be given priority here as well. In view of the fact that the calculated risk is on a level with the stipulated risk criterion, SSM finds that SKB needs to provide clarifications or supplementary information regarding these questions.

## D4 References

### Chapter D1

- Dverstorp, B., Sundström, B., Avila, R., Berglund, T., Hedberg, B., Jensen, M., Kautsky, F., Larsson, C.-M., Lilja, C., Lund, I., Löfgren, T., Moberg, L., Nordén, M., Simic, E., Strömberg, B., Toverud, Ö., Wiebert, A., Wingefors, S., Zika, H., 2003, SSI:s och SKI:s granskning av SKB:s uppdaterade Slutlig Säkerhetsrapport för SFR 1 Granskningsrapport, SSI rapport 2003:21, SKI rapport 2003:37, Statens strålskyddsinstitut, Stockholm, 2003.
- Geier, J., Review of Hydrogeological Models Supporting the SAFE SFR Final Safety Report, SSM dnr 2008/981, 2009
- Klos, R., Numerical modelling of SAR-08 biosphere objects, SSM dnr 2008/3158, 2009
- Klos, R och Shaw, G., Review of biosphere modelling in SAR-08, SSM dnr 2008/3158, 2009
- Kozak M. W., Assessment of SFR Analyses - Initial Simplified Assessment of Near Field Models, Report MSCI-2818-2 Rev 0.1, SSM dnr 2008/3239, 2009
- Limer, L., Albrecht, A., Marang, L., Smith, K., Thorne, M., Wiebert, A., Xu, S. och Smith, G., C-14 Long-Term Dose Assessment: Quantitative Model Comparison and Development, SSM dnr 2008/2982 Regeringen, Regeringsbeslut – Tillstånd enligt atomenergilagen (1956:306) att anlägga, inneha och driva ett slutförvar för låg- och medelaktivt avfall i Forsmark, beslut 62, 1983-06-22, Stockholm, 1983
- SKB, Slutförvar för radioaktivt driftavfall, SFR 1, Slutlig säkerhetsrapport, Svensk Kärnbränslehantering AB, Stockholm, 2001
- SKB, Angående SAFE-komplettering, 2005-12-08, SKB ref DL 10, Svensk Kärnbränslehantering AB, Stockholm, 2005.
- SKB, Begäran om anstånd med redovisningar, 2006-04-06, Svensk Kärnbränslehantering AB, Stockholm, 2006.
- SKB, SFR 1 - Slutlig säkerhetsrapport – pärm 1, Svensk Kärnbränslehantering AB, Stockholm, 2008a
- SKB, SFR 1 - Slutlig säkerhetsrapport – pärm 2, Svensk Kärnbränslehantering AB, Stockholm, 2008b
- SKI, SFR-1 – Ansökan om tillstånd för drifttagning, 1988-03-24, ref 7.41 955/87, Statens kärnkraftinspektion, Stockholm 1988.
- SKI, Kompletterande driftmedgivande för SFR-1, 1992-05-20, SKI dnr 7.41 433/88, Statens kärnkraftinspektion, Stockholm, 1992.
- SKI, Ytterligare villkor som behövs från säkerhetssynpunkt för Svensk Kärnbränslehantering AB:s tillstånd den 22 juni 1983 att anlägga, inneha och driva ett slutförvar för låg- och medelaktivt avfall i Forsmark, ref 7.49/011030, Statens kärnkraftinspektion, Stockholm, 2003
- SKI, Komplettering av den återkommande helhetsbedömningen av säkerheten för slutförvaret för låg- och medelaktivt avfall, SFR 1, 2008-0613, SKI dnr 2005/1200, dok. Nr. 67914, Statens kärnkraftinspektion, Stockholm, 2008
- SSI, Drifttillstånd för SFR-1 Etapp 1, 1988-03-30, Dnr 343/833/87, Statens strålskyddsinstitut, Stockholm 1988.
- SSI, Kompletterande driftmedgivande för SFR-1, etapp 1, SSI Dnr 833/1326/91, Statens strålskyddsinstitut, Stockholm, 1992.
- SSI, Begäran om kompletterande redovisningar angående SKB:s säkerhetsrapport för SFR 1, 2003-12-08, SSI dnr 6222/3019/01, Statens strålskyddsinstitut, Stockholm, 2003a
- SSI, beslut om begränsad drift för SFR 1 samt begäran om redovisning av uppfyllelse av strålskyddsvillkor för SFR 1, 2003-12-08, SSI dnr 6222/3745/03, Statens strålskyddsinstitut, 2003b
- SSI, Uppdaterade driftvillkor för SFR 1, 2003-12-08, SSI dnr 6222/3744/03, Statens strålskyddsinstitut, Stockholm, 2003c
- SSI, Föreläggande om redovisning, 2006-02-27, SSI dnr 2006/6-257, Statens strålskyddsinstitut, Stockholm, 2006.

SSI, Ansökan om anstånd med redovisningar, 2007-03-12, SSI dnr 2006/6257, Statens strålskydds-institut, Stockholm, 2007.

SSI 2008, Beslut rörande driften av slutförvaret för radioaktivt driftavfall vid Forsmark, SFR 1, 2008-03-19, SSI dnr 2006/6-257, Statens strålskyddsinstitut, Stockholm, 2008.

SSM, Strålsäkerhetsmyndighetens föreskrifter om säkerhet i kärntekniska anläggningar; Strålsäkerhetsmyndighetens allmänna råd om tillämpning av föreskrifterna (SSMFS 2008:1) om säkerhet i kärntekniska anläggningar, SSMFS 2008:1, Strålsäkerhetsmyndigheten, Stockholm, 2008.

SSM, Möjlighet att lämna synpunkter på uppgifter som tillförts ärendet vid granskningen av SFR SAR 08, 2009-08-27, Strålsäkerhetsmyndigheten, Stockholm, 2009

Stenhouse, M, Kozak, M. W och Zhou, W, Review and Assessment of SFR Analyses, Report MSC1-2818-1 Rev 0.1, SSM dnr 2008/3239, 2009

Zhou, W, Kozak, M. W., Xu, S. och Stenhouse, M., Review and Assessment of SFR 1 Long-term Safety Analyses, Report MSC1-2818-3 Rev 3, SSM dnr 2008/3239, 2009

## **Chapter D2**

Dverstorp, B., Sundström, B., Avila, R., Berglund, T., Hedberg, B., Jensen, M., Kautsky, F., Larsson, C.-M., Lilja, C., Lund, I., Löfgren, T., Moberg, L., Nordén, M., Simic, E., Strömberg, B., Toverud, Ö., Wiebert, A., Wingefors, S., Zika, H., 2003, SSI:s och SKI:s granskning av SKB:s uppdaterade Slutlig Säkerhetsrapport för SFR 1 Granskningsrapport, SSI rapport 2003:21, SKI rapport 2003:37, Statens strålskyddsinstitut, Stockholm, 2003.

Dverstorp, B., Strömberg, B., Brickstad, B., Lindgren, G., Liu, J., Toverud, T., Wallberg, P., Xu, S., Aghili, B., Andersson, P., In de Betou, J., Jensen, M., Merck, P. och Nordén, M., SKI:s och SSI:s gemensamma granskning av SKB:s säkerhetsrapport SR-Can – SKI Rapport 2008:19, SSI rapport 2008:04, Statens kärnkraftinspektion och Statens strålskyddsinstitut, Stockholm, 2008.

SKI, Ytterligare villkor som behövs från säkerhetssynpunkt för Svensk Kärnbränslehantering AB:s tillstånd den 22 juni 1983 att anlägg, inneha och driva ett slutförvar för låg- och medelaktivt avfall i Forsmark, ref 7.49/011030, Statens kärnkraftinspektion, Stockholm, 2003

SSI, Uppdaterade driftsvillkor för SFR 1, 2003-12-08, SSI dnr 6222/3744/03, Statens strålskydds-institut, Stockholm, 2003

### **Section D3.1**

Dverstorp, B., Sundström, B., Avila, R., Berglund, T., Hedberg, B., Jensen, M., Kautsky, F., Larsson, C.-M., Lilja, C., Lund, I., Löfgren, T., Moberg, L., Nordén, M., Simic, E., Strömberg, B., Toverud, Ö., Wiebert, A., Wingefors, S., Zika, H., 2003, SSI:s och SKI:s granskning av SKB:s uppdaterade Slutlig Säkerhetsrapport för SFR 1 Granskningsrapport, SSI rapport 2003:21, SKI rapport 2003:37, Statens strålskyddsinstitut, Stockholm, 2003.

Gunnarsson D, PM: Preliminary design for plugging of SFR, 2005

SKI, Ytterligare villkor som behövs från säkerhetssynpunkt för Svensk Kärnbränslehantering AB:s tillstånd den 22 juni 1983 att anlägg, inneha och driva ett slutförvar för låg- och medelaktivt avfall i Forsmark, ref 7.49/011030, Statens kärnkraftinspektion, Stockholm, 2003

SSI, Uppdaterade driftsvillkor för SFR 1, 2003-12-08, SSI dnr 6222/3744/03, Statens strålskydds-institut, Stockholm, 2003

### **Section D3.2**

Almkvist, L och Gordon, A., Low and intermediate level waste in SFR 1 – Reference waste inventory 2007, SKB R-07-17, Svensk Kärnbränslehantering AB, Stockholm, 2007

Dverstorp, B., Sundström, B., Avila, R., Berglund, T., Hedberg, B., Jensen, M., Kautsky, F., Larsson, C.-M., Lilja, C., Lund, I., Löfgren, T., Moberg, L., Nordén, M., Simic, E., Strömberg, B., Toverud, Ö., Wiebert, A., Wingefors, S., Zika, H., 2003, SSI:s och SKI:s granskning av SKB:s uppdaterade Slutlig Säkerhetsrapport för SFR 1 Granskningsrapport, SSI rapport 2003:21, SKI rapport 2003:37, Statens strålskyddsinstitut, Stockholm, 2003.

Riggare, P. och Johansson, C., Project SAFE – Low and intermediate level waste in SFR-1 – Reference waste inventory, SKB R-01-03, Svensk Kärnbränslehantering AB, Stockholm, 2003.

Lindgren m.fl. Correlation factors för C-14, Cl-36, Ni-59, Ni-63, Mo-93, Tc-99, I-129 and Cs-135, Kemakta AR-2006-11, Stockholm, 2007

Lundgren, K., Jod-129: Uppskattning av aktivitet i driftavfall från svenska LWR, SKB R-05-79, Svensk Kärnbränslehantering AB, Stockholm, 2005

Lundgren, K., Mo-93, Tc-99 och Cs-135: Uppskattning av aktivitet i driftavfall i svenska LWR, Alara Engineering 06-0031R, 2006-09-06, 20062006

Magnusson, Å., Stenström, K. och Aronsson, P-O, Characterization of 14C in process water systems, spent resins and off-gas of Swedish LWRs, Report 01/07 (LUNFD6/(NFFR-3102)/1-81/(2007), Lund Univeristy, Lund (Draft), 2007

Persson, P., Measurements of activity concentrations of 59Ni and 63Ni in spent ion exchange resins, ver 2.0, SKB R-05-77, Svensk Kärnbränslehantering AB, Stockholm, 2005

SKB, SKB SFR 1 – Svar på av SSI begärd redovisning enligt SSI-beslut 2006/6-257, daterat 2007-11-28, SKB id 1094549, 2008-01-31, Svensk Kärnbränslehantering AB, Stockholm 2008

SKB, e-post meddelande till SSM den 6 april 2009, SSM dnr 2008/981, Svensk Kärnbränslehantering AB, Stockholm, 2009.

Studsvik, Arbetsrapport – Avfall från isotopanvändare, NW-85/1064, 198512-11, Studsvik Energiteknik AB, Nyköping, 1985.

SSI, Granskningspromemoria: Slutförvar för reaktoravfall – SFR-1, SSI rapport 88-05, Statens strålskyddsinstitut, Stockholm, 1988

SSI, Uppdaterade driftsvillkor för SFR 1, 2003-12-08, SSI dnr 6222/3744/03, Statens strålskyddsinstitut, Stockholm, 2003a

SSI, beslut om begränsad drift för SFR 1 samt begäran om redovisning av uppfyllelse av strålskyddsvillkor för SFR 1, 2003-12-08, SSI dnr 6222/3745/03, Statens strålskyddsinstitut, 2003b

SSI, Föreläggande om redovisning, 2006-02-27, SSI dnr 2006/6-257, Statens strålskyddsinstitut, Stockholm, 2006.

SSI, Beslut rörande driften av slutförvaret för radioaktivt driftavfall vid Forsmark, SFR 1, 2008-03-19, Statens strålskyddsinstitut, Stockholm, 2008.

SSM, Minnesanteckningar möte mellan SKB och SSM om SFR SAR-08, 2009-03-31, SSM dnr 2008/981, Strålsäkerhetsmyndigheten, Stockholm 2009.

### **Section D3.3**

Klos, R och Shaw, G., Review of biosphere modelling in SAR-08, SSM dnr 2008/3158, 2009

SKB, Long-term safety for KBS-3 repositories at Forsmark and Laxemar – a first evaluation. Main report for the SR-Can project. SKB TR-06-09, Svensk Kärnbränslehantering AB, Stockholm, 2006

### **Section D3.4**

Dverstorp, B., Sundström, B., Avila, R., Berglund, T., Hedberg, B., Jensen, M., Kautsky, F., Larsson, C.-M., Lilja, C., Lund, I., Löfgren, T., Moberg, L., Nordén, M., Simic, E., Strömberg, B., Toverud, Ö., Wiebert, A., Wingefors, S., Zika, H., 2003, SSI:s och SKI:s granskning av SKB:s uppdaterade Slutlig Säkerhetsrapport för SFR 1 Granskningsrapport, SSI rapport 2003:21, SKI rapport 2003:37, Statens strålskyddsinstitut, Stockholm, 2003.

SSM, Strålsäkerhetsmyndighetens föreskrifter och allmänna råd (SSMFS 2008:37) om skydd av människors hälsa och miljön vid slutligt omhändertagande av använt kärnbränsle och kärnavfall, Strålsäkerhetsmyndigheten, Stockholm, 2008.

Vidstrand, P., Näslund, J.-O., Hartikainen, J., Svensson, U., 2007, Hydrogeological flux scenarios at Forsmark. Generic numerical flow simulations and compilation of climatic information for use in the safety analysis SFR 1 SAR-08, SKB R-07-63, Svensk Kärnbränslehantering AB, Stockholm.

### **Section D3.5**

Dverstorp, B., Sundström, B., Avila, R., Berglund, T., Hedberg, B., Jensen, M., Kautsky, F., Larsson, C.-M., Lilja, C., Lund, I., Löfgren, T., Moberg, L., Nordén, M., Simic, E., Strömberg, B., Toverud, Ö., Wiebert, A., Wingefors, S., Zika, H., 2003, SSI:s och SKI:s granskning av SKB:s uppdaterade Slutlig Säkerhetsrapport för SFR 1 Granskningsrapport, SSI rapport 2003:21, SKI rapport 2003:37, Statens strålskyddsinstitut, Stockholm, 2003.

SSM, Strålsäkerhetsmyndighetens föreskrifter och allmänna råd (SSMFS 2008:37) om skydd av människors hälsa och miljön vid slutligt omhändertagande av använt kärnbränsle och kärnavfall, Strålsäkerhetsmyndigheten, Stockholm, 2008.

Zhou, W., Kozak, M. W., Xu, S. och, Stenhouse, M. Review and Assessment of SFR 1 Long-term Safety Analyses, Report MSC1-2818-3 Rev 3, SSM dnr 2008/3239, 2009.

### **Section D3.6**

Bergström, U., Avila, R. och de la Cruz, I. (2008). Dose assessments for SFR 1. SKB R-08-15, Svensk Kärnbränslehantering AB, Stockholm.

### **Section D3.7**

Axelsson, C.-L., Mærsk Hansen, L., 1998, Update of structural models at SFR nuclear waste repository, Forsmark, Sweden, SKB R-98-05, Svensk Kärnbränslehantering AB, Stockholm.

Dverstorp, B., Sundström, B., Avila, R., Berglund, T., Hedberg, B., Jensen, M., Kautsky, F., Larsson, C.-M., Lilja, C., Lund, I., Löfgren, T., Moberg, L., Nordén, M., Simic, E., Strömberg, B., Toverud, Ö., Wiebert, A., Wingefors, S., Zika, H., 2003, SSI:s och SKI:s granskning av SKB:s uppdaterade Slutlig Säkerhetsrapport för SFR 1 Granskningsrapport, SSI rapport 2003:21, SKI rapport 2003:37, Statens strålskyddsinstitut, Stockholm.

Holmén, J.G., 2005, SFR-1 Inverse modelling of inflow to tunnels and propagation of estimated uncertainties to predictive stages, SKB R-05-74, Svensk Kärnbränslehantering AB, Stockholm.

Holmén, J.G., 2007, SFR inverse modelling part 2, Uncertainty factors of predicted flow in deposition tunnels and uncertainty in distribution of flow paths from deposition tunnels, SKB R-07-61, Svensk Kärnbränslehantering AB, Stockholm.

Holmén, J.G., Stigsson, M., 2001a, Modelling of future hydrogeological conditions at SFR, SKB R-01-02, Svensk Kärnbränslehantering AB, Stockholm.

Holmén, J.G., Stigsson, M., 2001b, Details of predicted flow in deposition tunnels at SFR, Forsmark, SKB R-01-21, Svensk Kärnbränslehantering AB, Stockholm.

Olsson O (ed), 1992, Site Characterization and Validation – Final Report. Technical Report of the Stripa Project, managed by Swedish Nuclear Fuel and Waste Management Co on behalf of OECD/NEA. SKB TR-92-22, 184 pp. Svensk Kärnbränslehantering AB, Stockholm.

SKB, 2008, Site description of Forsmark at completion of the site investigation phase, SDM-Site Forsmark, SKB TR-05-08, Svensk Kärnbränslehantering AB, Stockholm.

Vidstrand, P., Näslund, J.-O., Hartikainen, J., Svensson, U., 2007, Hydrogeological flux scenarios at Forsmark. Generic numerical flow simulations and compilation of climatic information for use in the safety analysis SFR 1 SAR-08, SKB R-07-63, Svensk Kärnbränslehantering AB, Stockholm.

### **Section D3.8**

Chambers A. (1995) Modelling radionuclide transport in cracks through cementitious radioactive waste, In Scientific Basis for Nuclear Waste Management XVIII (eds. Murakami T., Ewing R.).

Cronstrand P. (2007) Modelling of the long-term stability of the engineered barriers of SFR with respect to climate changes, Svensk Kärnbränslehantering AB, SKB R-07-51.

Emborg M., Jonasson J.-E., Knutsson S. (2007) Långtidsstabilitet till följd av frysning och tining av betong och bentonit vid förvaring av låg-och medelaktivt kärnavfall i SFR 1, Svensk Kärnbränslehantering AB, SKB R07-60.

Gaucher E., Tournassat C., Nowak C. (2005) Modelling of the geochemical evolution of the multi-barrier system of the Silo of the SFR repository. Svensk Kärnbränslehantering AB, SKB R-05-80.

Holmén J.G., Stigsson M. (2001) Modelling of future hydrological conditions at SFR. Svensk Kärnbränslehantering AB, SKB R-01-02.

Höglund L.O. (2001) Project SAFE Modelling of long-term concrete degradation processes in the Swedish SFR repository. Svensk Kärnbränslehantering AB, SKB R-01-08.

Savage D. (2009) Review of SKB reports on long-term stability of SFR barriers, Quintessa Limited, QRS-1470A-1.

SSM, Strålsäkerhetsmyndighetens föreskrifter och allmänna råd (SSMFS 2008:21) om säkerhet vid slutförvaring av kärnämne och kärnavfall, Strålsäkerhetsmyndigheten, Stockholm, 2008.

Zhou, W, Kozak M.W., Xu S., Stenhouse M. (2009) Review and Assessment of SFR-1 Long-term Safety Analyses, Monitor Scientific LLC, Report MSCI-2818-3.

### **Section D3.9**

Zhou, W, Kozak M.W., Xu S., Stenhouse M. (2009) Review and Assessment of SFR-1 Long-term Safety Analyses, Monitor Scientific LLC, Report MSCI-2818-3.

### **Section D3.10**

Bäckblom, G. och Munier, R., Effects of earthquakes on the deep repository for spent fuel in Sweden based on case studies and preliminary model results, SKB TR-02-24, Svensk Kärnbränslehantering AB, Stockholm, 2002.

### **Section D3.11**

Avila, R. och Pröhl, G. Models used in the SFR 1 SAR-08 and KBS-3H safety assessments for calculation of 14C doses. SKB R-08-16, Svensk Kärnbränslehantering AB, Stockholm, 2008

Bergström, U., Avila, R. och de la Cruz, I. Dose assessments for SFR 1. SKB R-08-15, Svensk Kärnbränslehantering AB, Stockholm, 2008.

Broed, R. och Xu, S., User's manual for Ecolego Toolbox and the Discretization Block. SSI Report 2008:10. Statens strålskyddsinstitut, Stockholm, 2007

Dverstorp, B., Sundström, B., Avila, R., Berglund, T., Hedberg, B., Jensen, M., Kautsky, F., Larsson, C.-M., Lilja, C., Lund, I., Löfgren, T., Moberg, L., Nordén, M., Simic, E., Strömberg, B., Toverud, Ö., Wiebert, A., Wingefors, S., Zika, H., 2003, SSI:s och SKI:s granskning av SKB:s uppdaterade Slutlig Säkerhetsrapport för SFR 1 Granskningsrapport, SSI rapport 2003:21, SKI rapport 2003:37, Statens strålskyddsinstitut, Stockholm, 2003

Hedin, A., E-mail to Björn Dverstorp and Bo Strömberg dated 19/3/07 on the subject of input files for SR-Can calculations, 2007

Holmén, J.G., Stigsson, M., Modelling of future hydrogeological conditions at SFR, SKB R-01-02, Svensk Kärnbränslehantering AB, Stockholm, 2001



- Jarsjö, J., Destouni, G., Persson, K. and Prieto, C., Solute transport in coupled inland-coastal water system. SKB report R-07-65. Svensk Kärnbränslehantering AB, 2007
- Karlsson, S., Bergström, U. and Meili, M., Models for dose assessments Models adapted to SFR-area, Sweden. SKB TR-01-04. Svensk Kärnbränslehantering AB, 2001
- Klos, R, Numerical modelling of SAR-08 biosphere objects, SSM dnr 2008/3158, 2009
- Klos, R., och Shaw, G., Review of biosphere modelling in SAR-08, SSM dnr 2008/3158, 2009
- Limer, L., Albrecht, A., Marang, L., Smith, K., Thorne, M., Wiebert, A., Xu, S., och Smith, G., C-14 Long-Term Dose Assessment: Quantitative Model Comparison and Development, SSM dnr 2008/2982, 2008
- Norman, S. and Kjellbert, N., FARF31 – A far field radionuclide migration code for use with the PROPER package. SKB TR 90-01, Svensk Kärnbränslehantering AB, 1990 SSM, Strålsäkerhetsmyndighetens föreskrifter och allmänna råd (SSMFS 2008:37) om skydd av människors hälsa och miljön vid slutligt omhändertagande av använt kärnbränsle och kärnavfall, Strålsäkerhetsmyndigheten, Stockholm, 2008.
- Thomson, G., Herben, M., Lloyd, P., Rose, D., Smith, C. och Barraclough, I., Implementation of project Safe in AMBER . Verification study for SFR 1 SAR-08. SKB R-01-13, Svensk Kärnbränslehantering AB, Stockholm, 2008a
- Thomson, G., Miller, A., Smith, G. och Jackson, D., Radionuclide release calculations for SAR-08. SKB R-08-14, Svensk Kärnbränslehantering AB, Stockholm, 2008b
- Xu, S, Wörman, A., Dverstorp, B., Klos, R., Shaw, G. and Marklund, L., SSI's independent consequence calculations in support of the regulatory review the SR-Can safety assessment. SSI Report 2008:08. Statens strålskyddsinstitut, Stockholm, 2007.
- Zhou, W., Kozak, M. W., Xu, S. och Stenhouse, M., Review and Assessment of SFR 1 Long-term Safety Analyses, Report MSC1-2818-3 Rev 3, SSM dnr 2008/3239, 2009

### **Section D3.12**

- Dverstorp, B., Sundström, B., Avila, R., Berglund, T., Hedberg, B., Jensen, M., Kautsky, F., Larsson, C.-M., Lilja, C., Lund, I., Löfgren, T., Moberg, L., Nordén, M., Simic, E., Strömberg, B., Toverud, Ö., Wiebert, A., Wingefors, S., Zika, H., 2003, SSI:s och SKI:s granskning av SKB:s uppdaterade Slutlig Säkerhetsrapport för SFR 1 Granskningsrapport, SSI rapport 2003:21, SKI rapport 2003:37, Statens strålskyddsinstitut, Stockholm, 2003
- Holmén, J.G., Stigsson, M., Modelling of future hydrogeological conditions at SFR, SKB R-01-02, Svensk Kärnbränslehantering AB, Stockholm, 2001
- SSM, Strålsäkerhetsmyndighetens föreskrifter och allmänna råd (SSMFS 2008:37) om skydd av människors hälsa och miljön vid slutligt omhändertagande av använt kärnbränsle och kärnavfall, Strålsäkerhetsmyndigheten, Stockholm, 2008.



## Terms and abbreviations

3DEC	Computer code used for modelling rock stability over time.
AB SVAFO	Company that treats nuclear waste and nuclear facilities from early Swedish nuclear research. AB SVAFO is owned by the nuclear power companies Forsmarks Kraftgrupp AB, Ringhals AB, Barsebäck Kraft AB and OKG AB.
AD	Anno Domini.
ADINA	Computer code used to calculate stresses in the earthquake scenario.
Advection	Transport of a dissolved substance by the bulk flow of water.
AMBER	Compartmental modelling code. (Assisted Model Building with Energy Refinement)
AMF	Assessment Model Flowchart.
AP	After Present.
BAT	Best Available Technique.
BC	Before Christ.
BCC	Biosphere Calculation Cases, details of the BCC are found in the Biosphere synthesis report.
BE	Best Estimate.
BLA	Vault for low-level waste.
BMA	Vault for intermediate-level waste.
BRT	Vault for reactor pressure vessels.
BST	Waste vault tunnel.
BT	Construction tunnel.
BTF	Vault for concrete tanks.
BWR	Boiling Water Reactor.
CCxx	Calculation Case xx.
CCSM4	Computer code used for simulations of past, present and future climates including dynamics of the atmosphere, oceans, sea-ice and land.
Clab	Central interim storage facility for spent nuclear fuel in Oskarshamn.
Clearance level	A value, established by a regulatory body and expressed in terms of activity concentration and/or total activity, at or below which a source of radiation may be released from regulatory control. (IAEA 2007)
Clink	Central interim storage and encapsulation plant. Clab and the encapsulation plant as an integrated unit.
Comsol Multiphysics	General computer code, in this assessment used for calculations of near-field waterflows and swelling of bituminised waste.
Conditioning	Those operations that produce a waste package suitable for handling, transport, storage and/or disposal. (IAEA 2007)
Connecting tunnel	General term used for tunnels outside waste vaults, for example BST and TT.
Control volume	Entities of the 3D-domain of the hydrological near-field model used to derive the water balance of the specified volume, for which flows across surfaces of the control volume are determined. Compartments of the near-field radionuclide transport model correspond with control volumes of the hydrological model or with fractions of them.
CR	Concentration Ratio. The concentration ratio is used to calculate uptake of radionuclides by biota and is defined as the element-specific concentration ratio between the concentration in biota and that in the surrounding medium (regolith or surface water).
CSH	Calcium Silicate Hydrates.
CT	Central Tunnel.
Darcy Tools	Computer code used for the hydrogeological calculations.
DCRL	Derived Consideration Reference Levels used for screening of exposure of animals and plants to ensure protection of the environment.
DEM	Digital Elevation Model.
DIC	Dissolved Inorganic Carbon.
DOC	Dissolved Organic Carbon.
DT	Operational tunnel (one of three access tunnels).
DTPA	Diethylene Triamine Pentaacetic Acid, a complexing agent.
EBS	Engineered Barrier System.
ECOCLAY-II	EU-project – Effects of cement on clay barrier performance – Phase II.
Ecolego	Computer code used for radionuclide transport and dose calculations.
EDTA	Ethylene Diamine Tetraacetic Acid, a complexing agent.
EDZ	Excavation Damaged Zone.
EPIC	EU-project that provided screening values to assess environmental risk. Environmental protection from ionising contaminants in the Arctic. <a href="https://wiki.ceb.ac.uk/display/rpemain/EPIC">https://wiki.ceb.ac.uk/display/rpemain/EPIC</a> .

ERICA	EU-project that provided screening values to assess environmental risk. Environmental Risk from Ionising Contaminants – Assessment and Management. <a href="https://wiki.ceh.ac.uk/display/rpemain/ERICA">https://wiki.ceh.ac.uk/display/rpemain/ERICA</a> .
ERICA Tool	Computer code used to obtain activity concentrations in and radiological effects on different types of non-human biota.
EU	European Union.
Eustatic changes	Changes in sea level due to changes in ocean water volume.
FARF31	Semi-analytic modelling code for modelling of radionuclide transport in the geosphere.
FASSET	EU-project that provided screening values to assess environmental risk. Framework for ASSESSment of Environmental Impact. <a href="https://wiki.ceh.ac.uk/display/rpemain/FASSET">https://wiki.ceh.ac.uk/display/rpemain/FASSET</a> .
FastReact	Computer code for reactive transport simulations along a set of streamlines based on mechanistic and geochemical processes.
FEP	Features, Events and Processes.
FHA	Future Human Actions.
F-PSAR	First Preliminary Safety Analysis Report.
GAP	The Greenland Analogue Project: a multilateral research project on Greenland's west coast (east of Kangerlussuaq).
GEKO/QI	The bentonite used in the silo.
GIA	Glacial Isostatic Adjustment.
GSG-1	IAEA's classification of radioactive waste (IAEA 2009) in which the waste is divided into six classes.
HC	Hydroxycarboxylic acids.
HFR	Percussion borehole.
IAEA	International Atomic Energy Agency.
ICRP	International Commission on Radiological Protection.
Initial state	The state that exists in SFR and its environs directly after closure.
Insolation	Incoming solar radiation.
IPCC	The Intergovernmental Panel on Climate Change.
ISA	Isosaccharinate, a complexing agent that is a cellulose degradation product.
ISO	International Organization for Standardization.
Isostatic changes	Vertical movements of the Earth's crust due to changes in e.g. ice-sheet loading.
ISRM	International Society for Rock Mechanics.
ka AP	kilo annum (thousands of years) after present.
KBS-3	Method developed by SKB for final disposal of spent fuel.
$K_d$	Partitioning coefficient for sorption [ $L^3/M$ ]. Partitioning coefficient is defined as the ratio between the element concentrations in the solid and liquid phases.
KFR	Cored boreholes.
Layout 1.5	Layout for SFR 3 from March 2012, used in the long-term safety assessment for SFR.
Layout 2.0	Final Layout for SFR 3 used in the application.
L/ILW	Low- and Intermediate Level Waste.
Legacy waste	Waste that was generated by past activities not associated with the operation or decommissioning of the nuclear facilities, production of nuclear energy or uses of radioisotopes in research, industrial and medical applications.
LOVECLIM	Computer code used together with CCSM4 to assess the potential for cold climate conditions in Forsmark. It includes the dynamics of the atmosphere, oceans, sea-ice and vegetation.
m.a.s.l.	Metres above sea level.
m.b.s.l.	Metres below sea level.
Macadam	Crushed rock sieved in fractions 2–65 mm. Macadam has no or very little fine material (grain size < 2mm). The fraction is given as intervals, for example "Macadam 16–32" is crushed rock comprising the fraction 16–32 mm.
MIKE SHE	Computer code used to simulate groundwater and surface water flow.
Montmorillonite	Swelling phyllosilicate; key component of bentonite.
MX-80	A brand name of bentonite clay.
NBT	Lower construction tunnel.
NDB	Lower drainage basin.
NEA	The Nuclear Energy Agency.
NEP	Net Ecosystem Production.
NRVB	Nirex reference vault backfill.
NSP	Lower silo plug.
NTA	Nitriiotriacetic acid, a complexing agent.

Object 157_1	The biosphere object 157_1 (see the map in Appendix H) is a present sea basin with an average depth of 11 meters and a maximum depth of 16.5 meters. At 4,500 AD the future lake will be isolated. The total isolation process takes about 400 years. The mean depth of the lake at isolation will be 2 meters with a maximum depth of 3 meters. During the next period of 1,200 years, the lake slowly undergoes sediment accumulation and ingrowth of vegetation. At 5,700 AD the lake becomes infilled and only a small stream passes through the object area, draining the 157 catchment and the upstream area of 157_2.
Object 157_2	The biosphere object 157_2 (see the map in Appendix H) is at present below sea level (average depth 5.8 and maximum depth 13.5 meters). The object area will have no future lake and the succession from a marine to a terrestrial ecosystem will take place without a lake stage. The starting point of the transition from a marine to a terrestrial ecosystem is in 3,000 AD and the total area becomes land at 4,500 AD. Hydrological modelling shows an area with high water levels in the upper soil and a wetland will form after the sea has withdrawn due to shoreline displacement. The object drains down to object 157_1 in the surface water flow network.
OPC	Ordinary Portland Cement.
Package/ Waste package	The product of conditioning that includes the waste form and any container(s) and internal barriers (e.g. absorbing materials and liner), as prepared in accordance with requirements for handling, transport, storage and/or disposal. (IAEA 2007)
Packaging	The assembly of components necessary to enclose the radioactive contents completely. It may, in particular, consist of one or more receptacles, absorbent materials, spacing structures, radiation shielding and service equipment for filling, emptying, venting and pressure relief; devices for cooling, absorbing mechanical shocks, handling and tie-down, thermal insulation; and service devices integral to the package. The packaging may be a box, drum, or similar receptacle, or may also be a freight container, tank, or intermediate bulk container. (IAEA 2007)
Periglacial climate domain	Regions that contain permafrost without the presence of an ice sheet.
PFL-f	Discrete inflow detected by the Posiva Flow Logging method.
Phast	Computer code used for concrete degradation calculations and geochemical evolution in the geosphere.
PhreeqC	Computer code used for geochemical modelling of the evolution of repository pH and redox.
Project FEPs	FEPs included in the NEA FEP database that have been identified within different organisations' safety assessments projects.
PROTECT	EU-project that provided screening values to assess environmental risk. Protection of the environment from ionising radiation in a regulatory context. <a href="https://wiki.ceb.ac.uk/display/rpemain/PROTECT">https://wiki.ceb.ac.uk/display/rpemain/PROTECT</a> .
PSAR	Preliminary Safety Analysis Report.
PSS	Pipe String System device.
PSU	Project SFR extension.
PWR	Pressure Water Reactor.
PVC	Polyvinyl chloride.
RD&D	Research, Development and Demonstration.
RDC	Reducing capacity.
RDM	Regolith depth model.
Rebound	Uplift of the continental crust as a response to deglaciation.
Regolith	Used to designate all deposits on bedrock, including Quaternary deposits, soils, sediments, peat, organic debris, surface of rock outcrops and man-made structures.
Repository system	Defined as the deposited waste, the waste packaging, the engineered barriers, the host rock and the biosphere surrounding the repository. Synonymous with repository and its environs.
RHB 70	The Swedish geographical height system.
RN	Radionuclide.
RPV	Reactor pressure vessel.
RTT	One of three access tunnels (Reactor transport tunnel).
SAFE	Long-term safety assessment for SFR reported to the regulatory authorities in 2001.
Safety function	A role through which a repository component contributes to safety.
Safety function indicator	A measurable or calculable property of a repository component that indicates the extent to which a safety function is fulfilled.
SAR	Safety Analysis Report.
SAR-08	Long-term safety assessment for SFR reported to the regulatory authorities in 2008.
SBA	Shallow Bedrock Aquifer. Sections with an elevated frequency of gently dipping fractures in the rock mass between the geologically modelled steeply dipping deformation zones.
SDM	Site Descriptive Model. A synthesis of geology, rock mechanics, thermal properties, hydrogeology, hydrogeochemistry, bedrock transport properties and surface system properties of the site for the repository.
SDM-PSU	Site Descriptive Model for the SFR area.
SDM-Site	Site Descriptive Model for the Forsmark site for the spent fuel repository.

SFL	Final repository for long-lived low- and intermediate-level radioactive waste.
SFR	Repository in Forsmark for low-and intermediate-level radioactive waste.
SFR 1	Existing part of SFR.
SFR 3	Extension to SFR.
SGU	Geological Survey of Sweden.
Silo	Cylindrical vault for intermediate-level waste (part of SFR 1).
SKB	Swedish Nuclear Fuel and Waste Management Company.
SKI	Swedish Nuclear Power Inspectorate. SKI and SSI were merged into the Swedish Radiation Safety Authority (SSM) July 2008.
SMHI	Swedish Meteorological and Hydrological Institute.
Sorption	In this report, the term is used to designate all processes by which a dissolved species is retained at a solid surface.
SR-97	Safety Report 97. Preliminary safety assessment for the planned spent nuclear fuel repository, published in 1999.
SR-Can	The preliminary safety assessment for the planned spent nuclear fuel repository, published in 2006.
SR-PSU	This long-term safety assessment (Safety Report – Project SFR Extension).
SR-Site	Long-term safety assessment for a spent fuel repository in Forsmark reported to the regulatory authority in 2011.
SSI	Swedish Radiation Protection Authority. SSI and SKI were merged into the Swedish Radiation Safety Authority (SSM) July 2008.
SSM	Swedish Radiation Safety Authority. SSI and SKI were merged into the Swedish Radiation Safety Authority July 2008.
SSMFS	Regulations of the Swedish Radiation Safety Authority.
STP	Silo roof plug.
STT	Silo roof tunnel.
System component	A physical component of the repository system; a sub-system.
$T_{1/2}$	Radioactive half life.
Talik	A layer or body of unfrozen ground occurring in a permafrost area due to a local anomaly in thermal, hydrological, hydrogeological or hydrochemical conditions.
Temperate climate domain	Region without permafrost or the presence of ice sheets. It is dominated by a temperate climate in a broad sense, with cold winters and either cold or warm summers. Within the temperate domain, the site of SFR may also at times be submerged by the sea.
THM	Thermo-Hydro-Mechanical.
TOC	Total Organic Carbon.
Transition material	Component in earth dam plug e.g. 30/70 mixture bentonite and crushed rock. The role of the transition material is to hinder bentonite transport out from the hydraulic tight section, to take up the load from bentonite swelling and transfer it to the backfill material.
TT	Transverse Tunnel.
UMISM	Computer code used for reconstructing the ice sheet for the last glacial cycle for the construction of the Weichselian glacial cycle climate case, and for input to simulations of other phenomena such as permafrost, isostatic changes, crustal stress, and groundwater flow (University of Maine Ice Sheet Model).
UNSCEAR	United Nations Scientific Committee on the Effects of Atomic Radiation.
V-SMOW	Vienna Standard Mean Ocean Water. VSMOW is the standard against which isotopic compositions of both hydrogen and oxygen are reported.
WAC	Waste Acceptance Criteria.
Waste form	The physical and chemical form after treatment and/or conditioning. (IAEA 2007).
Waste package	The waste (form) and its packaging.
Waste packaging	The outer barrier protecting the waste form. Includes the assembly of components (e.g. absorbant materials, spacing structures, radiation shielding, service equipment, etc. (IAEA 2007).
Waste type	In order to systematically classify the wastes, different waste types have been defined and a code system developed.
Waste vault	Part of repository where waste is stored.
Weichselian glacial cycle	The last 120,000 year long glacial cycle in north-eastern Europe.
WRA	Water Reducing Admixtures.
ÖSP	Upper silo plug.

---

## Tables related to the handling of FEPs

This appendix provides tables that have been prepared for each system component to show the handling of each internal process, based on the handling documented in the **Process reports** and the report treating the handling of biosphere processes (SKB 2014b).

The appendix also includes a table with a summary of assessment activities included in the Assessment Model Flowchart (Appendix G) including a statement of which processes are included in each assessment activity, where the assessment activity is documented, and which couplings deliver input data to each assessment activity.

### Waste form

**Table F-1. Internal processes in the waste form and handling in SR-PSU.**

Process	Handling
WM01 Radioactive decay	The process is included in the model calculations of radionuclide transport.
WM02 Radiation attenuation/heat generation	Radiation attenuation is neglected, due to the low radioactivity. Heat generation caused by radiation in the waste has been shown to be negligible, as has heat generation from corrosion, due to the low radioactivity and limited quantities of aluminium in the waste.
WM03 Radiolytic decomposition of organic material	Swelling due to radiolytic decomposition of bitumen is neglected due to the low radioactivity of the waste and the fact that it is judged to be subordinate to swelling due to water uptake. Formation of complexing agents, e.g. oxalic acid, from degradation of bitumen is neglected due to negligible radiolytic degradation of bitumen under the conditions prevailing in the waste. Ettringite formation from release of sulphate is neglected due to the negligible radiolytic degradation rate of the ion-exchange resins.
WM04 Water radiolysis	Water radiolysis in the waste has been shown to be negligible due to the low radioactivity of the waste.
WM05 Heat transport	The temperature evolution in SFR is controlled completely by the external conditions, i.e. the temperature is determined by the surrounding rock. The influence of the temperature evolution on radionuclide transport is neglected.
WM06 Phase changes/freezing	Freezing is expected to result in structural degradation (cracking) of cement, concrete and bitumen, materials that are present as a stabilising matrix in different waste packages. This is handled by choosing suitable values of hydraulic conductivity and diffusivity in the modelling of e.g. water flow, concrete degradation and radionuclide transport.
WM07 Water uptake and transport during unsaturated conditions	Water uptake and water transport during unsaturated conditions are only relevant during a short initial period. Water uptake defines the time when release of radionuclides begins. Due to the fact that unsaturated conditions prevail for a relatively short time, no further handling is deemed to be needed in the safety assessment.
WM08 Water transport under saturated conditions	The process "water flow under saturated conditions" will be crucial for the safety assessment. The water flow through the waste is estimated by numerical modelling. The time at which water saturation is reached in different parts of the repository is estimated by numerical modelling.
WM09 Fracturing	Fracturing is handled by choosing suitable values of hydraulic conductivity and diffusivity in the modelling of e.g. water flow, concrete degradation and radionuclide transport.
WM10 Advective transport of dissolved species	Advection plays a central role for the transport of dissolved species in all parts of SFR, including the waste. The advection process is included in the modelling of e.g. concrete degradation and radionuclide transport.
WM11 Diffusive transport of dissolved species	Diffusion plays a central role for the transport of dissolved species in all parts of SFR, including the waste. The diffusion process is included in the modelling of e.g. concrete degradation and radionuclide transport.

<b>Process</b>	<b>Handling</b>
WM12 Sorption/uptake	Sorption/uptake of radionuclides is included in the modelling of radionuclide transport. Sorption/uptake is quantified by using partitioning coefficient (Kd) values, which are dependent on element/oxidation state.  Credit is not taken for sorption/uptake of radionuclides on matrices other than cement.
WM13 Colloid formation and transport	Low concentrations of colloids are expected in most parts of the repository, so the influence of colloids on radionuclide transport is neglected in the main scenario. Bitumen colloids are expected in high concentrations in those parts of the repository that contain bitumen. However, the degree of complexation with radionuclides is expected to be low, so the influence of bitumen colloids on radionuclide transport is neglected.
WM14 Dissolution, precipitation and recrystallisation	The durability of the cement matrix is important, since degradation can affect pH. The durability of the cement matrix is evaluated by reactive transport modelling.
WM15 Degradation of organic materials	Degradation of cellulose to ISA in an alkaline environment is the only chemical degradation process that is significant for safety.  Other chemicals present in SFR have been judged to be stable under the conditions that prevail in SFR or to degrade to substances that are not expected to influence sorption. Their ability to influence the mobility of radionuclides is therefore judged in their original form.
WM16 Water uptake/swelling	Knowledge of swelling pressure as a function of expansion volume is used to evaluate how much pressure structures and barriers surrounding bituminised waste will experience.  The effect of water uptake on the subsequent release of radionuclides is handled by assigning appropriate release rates for the radionuclides from the bituminised waste.
WM17 Microbial processes	Due to the expected high pH, the effect of microbial processes on the function of the repository is neglected from a safety assessment perspective, with the exception of the gas formation process.
WM18 Metal corrosion	Formation of fractures due to less dense corrosion products is included qualitatively in the choice of hydraulic conductivities.  Corrosion of metallic waste is taken into account as a contribution to the creation of reducing conditions. The evolution of redox conditions is modelled.  The metal corrosion process is judged to be one of the main gas formation processes.
WM19 Gas formation and transport	The volume of gas that is formed is calculated.  Gas transport in the waste is not treated specifically. The waste is considered only as a source of gas. Displacement of pore water containing radionuclides is modelled as a function of gas formation.
WM20 Speciation of radionuclides	Speciation of the redox-sensitive radionuclides Se, Tc, Np and Pu is calculated with thermodynamic data (i.e. assuming equilibrium).  The radionuclide concentrations in the waste are estimated (based on the inventory and geometrical considerations) to be below all relevant solubility limits.  Speciation of non-redox sensitive radionuclides is taken into account indirectly by the choice of Kd values.
WM21 Transport of radionuclides in the water phase	Radionuclide transport in the waste is included in the radionuclide transport model for the whole repository system.
WM22 Transport of radionuclides in the gas phase	Formation of methane due to microbial activity has been shown to be subordinate, as long as there are other electron acceptors present. Release of C-14 as methane is handled by scoping calculations.



## Waste packaging

**Table F-2. Internal processes in the waste packaging and handling in SR-PSU.**

Process	Handling
Pa01 Heat transport	See waste form, WM05.
Pa02 Phase changes/freezing	See waste form, WM06.
Pa03 Water uptake and transport during unsaturated conditions	See waste form, WM07.
Pa04 Water transport under saturated conditions	See waste form, WM08.
Pa05 Fracturing/deformation	There are no requirements regarding the long-term function of steel packaging. For concrete packaging, see waste form, WM09.
Pa06 Advective transport of dissolved species	See waste form, WM10.
Pa07 Diffusive transport of dissolved species	Diffusion in concrete packaging, see waste form process WM11. In the case of steel packaging, no credit is given for transport resistance in the modelling, due to uncertainties in the extent of corrosion during the operational phase.
Pa08 Sorption/uptake	See waste form, WM12.
Pa09 Colloid transport and filtering	See waste form, WM13.
Pa10 Dissolution, precipitation and recrystallisation	The durability of the concrete packaging is important, since its degradation can affect the pH in the near-field of the repository. The degradation rate also affects the chemical conditions in the waste and nearby concrete barriers. Concrete packaging is evaluated as a part of the waste domain in the long-term reactive transport modelling, hence these processes are not treated separately.
Pa11 Microbial processes	Microbial processes in the steel and concrete packaging are neglected.
Pa12 Metal corrosion	Steel packaging is assumed not to have any long-term barrier function in the safety assessment. Metal corrosion is included explicitly since it contributes to reducing conditions. Metal corrosion is also included in the safety assessment as one of the dominant gas-generating processes.
Pa13 Gas formation and transport	The quantity of H <sub>2</sub> (g) from corrosion of steel is included in the calculations of the amount of gas formed. The gas is assumed to be released from the packaging without delay and without causing any damage.
Pa14 Speciation of radionuclides	See waste form, WM20
Pa15 Transport of radionuclides in the water phase	For concrete packaging, see waste form process WM21. In the case of steel packaging, no credit is given for transport resistance in the modelling due to uncertainties in the extent of corrosion during the operational phase.
Pa16 Transport of radionuclides in the gas phase	It is assumed that the packaging does not offer any transport resistance to gases.

## 1–2BMA

**Table F-3. Internal processes in 1–2BMA and handling in SR-PSU.**

Process	Handling
BMABa01 Heat transport	Handled as a boundary condition.
BMABa02 Phase changes/freezing	Concrete: Assumed to fracture during permafrost. Crushed rock: Not affected by freezing.
BMABa03 Water uptake and transport during unsaturated conditions	The time to water saturation is estimated with a simple model.
BMABa04 Water transport under saturated conditions	Determination of initial transport properties (hydraulic conductivity). Analysis of the effect of concrete degradation on hydraulic conductivity. Modelling of water transport in BMA under different conditions.
BMABa05 Gas transport/dissolution	Analysis of displacement of contaminated water due to gas build-up.
BMABa06 Mechanical processes	Analysis: <i>Crushed rock</i> : Load from self-weight, subsidence at water saturation – provides information on space at the roof. Effect of rock fallout. Deformation due to gas pressure. Hydraulic load and creep are neglected. <i>Concrete</i> : Stresses caused by the own weight of the concrete, the backfill and the waste packages as a consequence of concrete degradation. Stresses caused by a swelling waste form, rebar corrosion, freezing and fracturing (see freezing and concrete degradation). Indirect effects of rock fallout, hydraulic load and creep are neglected.
BMABa07 Advection and dispersion	Included in modelling of radionuclide transport and concrete degradation.
BMABa08 Diffusion	Included in modelling of radionuclide transport and concrete degradation.
BMABa09 Sorption on concrete/shotcrete	Included in modelling of radionuclide transport.
BMABa10 Sorption on crushed rock backfill	Included in modelling of radionuclide transport.
BMABa11 Colloid stability, transport and filtering	Low concentrations of colloids are expected under cementitious conditions in the barriers and hence the influence of colloids on radionuclide transport has been neglected in the main scenario.
BMABa12 Concrete degradation	Evaluated with a reactive transport model.
BMABa13 Aqueous speciation and reactions	Included as a component in analysis of sorption, diffusion and concrete degradation.
BMABa14 Microbial processes	The process can be neglected during the period with high pH.
BMABa15 Metal corrosion	Included in analysis of fracturing in concrete, build-up of gas phase and determination of redox conditions.
BMABa16 Gas formation	Included in analysis of fracturing in concrete, build-up of gas phase and determination of redox conditions.
BMABa17 Speciation of radionuclides	Included in radionuclide transport in the water phase.
BMABa18 Transport of radionuclides in the water phase	Included in the radionuclide transport model for the whole repository.
BMABa19 Transport of radionuclides in the gas phase	Treated in a separate simplified case.

## 1–2BTF

**Table F-4. Internal processes in 1–2BTF and handling in SR-PSU.**

Process	Handling
BTFBa01 Heat transport	Handled as a boundary condition.
BTFBa02 Phase changes/freezing	Concrete: Assumed to fracture during permafrost. Crushed rock: Not affected by freezing.
BTFBa03 Water uptake and transport during unsaturated conditions	The time to water saturation is estimated with a simple model.
BTFBa04 Water transport under saturated conditions	Determination of initial transport properties (hydraulic conductivity). Analysis of the effect of concrete degradation on hydraulic conductivity. Modelling of water transport in 1–2BTF under different conditions.
BTFBa05 Gas transport/dissolution	Analysis of displacement of contaminated water due to gas build-up.
BTFBa06 Mechanical processes	Analysis of: <i>Sand</i> : Load from self-weight, subsidence at water saturation – provides information on space at the roof. Effect of rock fallout. Deformation due to gas pressure. Hydraulic load and creep are neglected. <i>Concrete</i> : Stresses caused by the self-weight of the concrete, the backfill and the waste packages as a consequence of concrete degradation. Effects of rebar corrosion, freezing and cracking (see freezing and concrete degradation). Indirect effects of rock fallout, hydraulic load and creep are neglected.
BTFBa07 Advection and dispersion	Included in modelling of radionuclide transport and concrete degradation.
BTFBa08 Diffusion	Included in modelling of radionuclide transport and concrete degradation.
BTFBa09 Sorption	Included in modelling of radionuclide transport.
BTFBa10 Colloid stability, transport and filtering	Low concentrations of colloids are expected under cementitious conditions in the barriers and hence the influence of colloids on radionuclide transport has been neglected in the main scenario.
BTFBa11 Concrete degradation	Evaluated with a reactive transport model.
BTFBa12 Aqueous speciation and reactions	Included as a component in analysis of sorption, diffusion and concrete degradation.
BTFBa13 Microbial processes	The process can be neglected during the period with high pH.
BTFBa14 Metal corrosion	Included in analysis of build-up of gas phase and determination of redox conditions.
BTFBa15 Gas formation	Included in analysis of build-up of gas phase and determination of redox conditions.
BTFBa16 Speciation of radionuclides	Included in radionuclide transport in the water phase.
BTFBa17 Transport of radionuclides in the water phase	Included in the radionuclide transport model for the whole repository.
BTFBa18 Transport of radionuclides in the gas phase	Treated in a separate simplified case.

## Silo

**Table F-5. Internal processes in the silo and handling in SR-PSU.**

Process	Handling
SiBa01 Heat transport	Handled as a boundary condition.
SiBa02 Phase changes/freezing	Concrete: Assumed to fracture during permafrost. Crushed rock: Not affected by freezing. Bentonite: Analysis of freezing sequence, with ice-lens formation.
SiBa03 Water uptake and transport during unsaturated conditions	Modelling of the water saturation process.
SiBa04 Water transport under saturated conditions	Determination of initial transport properties (hydraulic conductivity). Estimate of the consequences of piping/erosion. Analysis of the effect of concrete degradation on hydraulic conductivity and volume changes. Analysis of the effect of bentonite/concrete interaction. Modelling of water transport in the silo under different conditions. Sensitivity analyses.
SiBa05 Gas transport/dissolution	Analysis of the importance of gas pressure on the mechanical integrity of the silo. Analysis of displacement of contaminated water due to gas build-up.
SiBa06 Piping/erosion	Analysis of mass loss of bentonite.
SiBa07 Mechanical processes	Analysis of: <i>Wall fill of bentonite:</i> Load from self-weight, hydraulic load, swelling during wetting, swelling pressure after wetting and deformation. Self-healing after piping. Effects of cement degradation. Effect of rock fallout. Indirect effects of cement/bentonite interaction. Effect of ion exchange. <i>Top fill:</i> Load from self-weight, subsidence at water saturation – provides information on space at the roof. Effect of rock fallout. Deformation due to gas pressure. Hydraulic load and creep are neglected. <i>Concrete:</i> Stresses caused by the self-weight of the concrete, the backfill and the waste packages as a consequence of concrete degradation. Stresses caused by a swelling waste form, rebar corrosion, freezing and cracking (see freezing and concrete degradation). Indirect effects of rock fallout, hydraulic load and creep are neglected. <i>Bottom fill:</i> The processes in the bottom filling are not important for the performance and will not be analysed.
SiBa08 Advection and dispersion	Included in modelling of water saturation. Can be neglected in a functioning silo. Included in radionuclide transport calculations for a defective bentonite barrier.
SiBa09 Diffusion	Included in modelling of concrete/bentonite interaction. Included in modelling of water saturation. Included in modelling of radionuclide transport.
SiBa10 Sorption (including ion exchange of major ions)	Included in modelling of concrete/bentonite interaction. Included in modelling of radionuclide transport. Included in modelling of ion exchange.
SiBa11 Alteration of impurities	Included in modelling of concrete/bentonite interaction.
SiBa12 Colloid transport and filtering	Colloids are neglected.
SiBa13 Concrete degradation	Evaluated with a reactive transport model.
SiBa14 Dissolution/precipitation	Included in modelling of concrete/bentonite interaction.
SiBa15 Aqueous speciation and reactions	Included as a component in analysis of sorption, diffusion and concrete degradation.
SiBa16 Osmosis	Evaluated with empirical data for swelling pressure as a function of salinity.
SiBa17 Montmorillonite transformation	Included in modelling of concrete/bentonite interaction.

<b>Process</b>	<b>Handling</b>
SiBa18 Iron-bentonite interaction	Neglected compared with concrete/bentonite interaction.
SiBa19 Montmorillonite colloid release	Neglected, Ca concentration from cement is sufficient to suppress this process.
SiBa20 Microbial processes	The process can be neglected during the period with high pH.
SiBa21 Cementation in bentonite	Included in modelling of concrete/bentonite interaction.
SiBa22 Metal corrosion	Included in analysis of fracturing in concrete, build-up of gas phase and determination of redox conditions.
SiBa23 Gas formation	Included in analysis of fracturing in concrete, build-up of gas phase leading to pressure build-up, and determination of redox conditions.
SiBa24 Speciation of radionuclides	Included in radionuclide transport in the water phase.
SiBa25 Transport of radionuclides in the water phase	Included in the radionuclide transport model for the whole repository.
SiBa26 Transport of radionuclides in the gas phase	Treated in a separate simplified case.

## 1-5BLA

**Table F-6. Internal processes in 1-5BLA and handling in SR-PSU.**

Process	Handling
BLABa01 Heat transport	Handled as a boundary condition.
BLABa02 Phase changes/freezing	Concrete: Assumed to crack during permafrost. Crushed rock: Not affected by freezing.
BLABa03 Water uptake and transport during unsaturated conditions	Assumed to be fast.
BLABa04 Water transport under saturated conditions	Included in the hydrological modelling of SFR.
BLABa05 Gas transport/dissolution	Neglected, since all gases formed in the waste form and packaging can be assumed to be transported out from the vault into the geosphere without substantial pressure build-up.
BLABa06 Mechanical processes	Neglected, since the rock fallout from the roof and walls is not expected to influence the performance.
BLABa07 Advection and dispersion	Included in modelling of radionuclide transport.
BLABa08 Diffusion	Neglected, since systems will be assumed to be completely mixed for the safety assessment, with advection-dominated flow conditions.
BLABa09 Sorption	Included in modelling of radionuclide transport, but no credit is taken for sorption on the small amounts of cementitious materials present.
BLABa10 Colloid stability, transport and filtering	Neglected, due to high ionic strength expected during temperate conditions.
BLABa11 Aqueous speciation and reactions	Included as a component in the analysis of sorption.
BLABa12 Microbial processes	The process is considered irrelevant for the description of BLA.
BLABa13 Degradation of rock bolts, reinforcement and concrete	Neglected, no credit is taken for sorption on these materials.
BLABa14 Speciation of radionuclides	Included in radionuclide transport in the water phase.
BLABa15 Transport of radionuclides in the water phase	Included in the radionuclide transport model for the whole repository.
BLABa16 Transport of radionuclides in the gas phase	Treated in a separate simplified case.

**BRT****Table F-7. Internal processes in BRT and handling in SR-PSU.**

<b>Process</b>	<b>Handling</b>
BRTBa01 Heat transport	Handled as a boundary condition.
BRTBa02 Phase changes/freezing	Concrete: Assumed to fracture during permafrost. Macadam: Not affected by freezing.
BRTBa03 Water uptake and transport during unsaturated conditions	Assumed to be fast.
BRTBa04 Water transport under saturated conditions	Included in the hydrological modelling of SFR.
BRTBa05 Gas transport/dissolution	Neglected, since all gases formed in the waste form and packaging can be assumed to be transported out from the vault into the geosphere without excessive pressure build-up.
BRTBa06 Mechanical processes	Neglected, since the rock fallout from the roof and walls is not expected to influence the performance. No credit is taken for the hydraulic performance of the concrete.
BRTBa07 Advection and dispersion	Included in modelling of radionuclide transport.
BRTBa08 Diffusion	Neglected, since systems will be assumed to be completely mixed for the safety assessment, with advection dominated flow conditions.
BRTBa09 Sorption	Included in modelling of radionuclide transport.
BRTBa10 Colloid stability, transport and filtering	Low concentrations of colloids are expected under cementitious conditions in the barriers and hence the influence of colloids on radionuclide transport has been neglected in the main scenario.
BRTBa11 Concrete degradation	Evaluated with a reactive transport model. Assumed to be analogous with BMA.
BRTBa12 Aqueous speciation and reactions	Included as a component in analysis of sorption.
BRTBa13 Microbial processes	The process can be neglected during the period with high pH.
BRTBa14 Metal corrosion	Included in analysis of fracturing in concrete, build-up of gas phase leading to pressure build-up, and determination of redox conditions.
BRTBa15 Gas formation	Included in analysis of fracturing in concrete, build-up of gas phase leading to pressure build-up, and determination of redox conditions.
BRTBa16 Speciation of radionuclides	Included in radionuclide transport in the water phase.
BRTBa17 Transport of radionuclides in the water phase	Included in the radionuclide transport model for the whole repository.
BRTBa18 Transport of radionuclides in the gas phase	Treated in a separate simplified case.

## Plugs and other closure components

**Table F-8. Internal processes in plugs and other closure components and handling in SR-PSU.**

Process	Handling
Pg01 Heat transport	Handled as a boundary condition.
Pg02 Phase changes/freezing	Concrete: Assumed to fracture during permafrost. Crushed rock: Not affected by freezing. Bentonite: Analysis of freezing sequence, with ice lens formation.
Pg03 Water uptake and transport during unsaturated conditions	Modelling of water saturation process.
Pg04 Water transport under saturated conditions	Sensitivity studies to assess the importance of long-term plug degradation.
Pg05 Gas transport/dissolution	Analysis of the importance of gas pressure on the mechanical integrity of the plugs.
Pg06 Piping/erosion	Analysis of mass loss of bentonite.
Pg07 Mechanical processes	Analysis of: Swelling and homogenisation of the plugs, interaction between bentonite plugs and degraded concrete plugs, interaction between bentonite plugs and transition areas and backfill, effects of void areas, effects of mass losses.
Pg08 Advection and dispersion	Evaluated from the modelling of the repository's hydraulic function.
Pg09 Diffusion	Neglected, as the diffusive resistance can be expected to be higher in the plugs than in their environment.
Pg10 Sorption (including ion exchange of major ions)	Neglected, since it is expected that solutes will not be transported to the plugs by either advection or diffusion.
Pg11 Alteration of impurities in bentonite	Neglected, as the diffusive resistance can be expected to be higher in the plugs than in their environment.
Pg12 Dissolution, precipitation, recrystallisation and clogging in backfill	Neglected, since the process will have very limited or no impact on the repository performance.
Pg13 Aqueous speciation and reactions	Neglected, in case of the plugs as the resistance to transport of reactants can be expected to be higher in the plugs than in their environment, for the other components the process will have very limited or no impact on the repository performance.
Pg14 Osmosis	Based on the projected hydraulic resistance of the plugs, the process is neglected.
Pg15 Montmorillonite transformation	The process is neglected, based on the high resistance to transport of reactants into the plugs.
Pg16 Montmorillonite colloid release	Ca concentration from cement is sufficient to suppress this process.
Pg17 Microbial processes	Neglected, the processes will have very limited or no impact on the repository performance.
Pg18 Degradation of rock bolts, reinforcement and concrete	The degradation process itself is neglected. The consequences are handled in Pg07.
Pg19 Speciation of radionuclides	Neglected, since it is expected that solutes will not be transported to the plugs by either advection or diffusion.
Pg20 Transport of radionuclides in the water phase	Indirectly via the hydrological model.
Pg21 Transport of radionuclides in the gas phase	Irrelevant.



## Geosphere

**Table F-9. Internal processes in the geosphere and handling in SR-PSU. Processes Ge08 and Ge18 have been excluded (merged with other processes).**

Process	Handling
Ge01 Heat transport	The heat flux from the deep geosphere is represented explicitly in modelling of permafrost development at Forsmark.
Ge02 Freezing	Modelled with coupled climate and 2D permafrost model. Considered in radionuclide transport calculations.
Ge03 Groundwater flow	Groundwater flow under saturated conditions is modelled. Uniform groundwater density (i.e. not density-driven flow) is assumed at all times and in the permafrost modelling as well.
Ge04 Gas flow/dissolution	Gas flow is fast compared to groundwater flow and hence gas dissolution is neglected. Gas transport is handled in Ge24. Natural (geothermal) gases from the deep geosphere are not expected at these superficial elevations.
Ge05 Deformation in intact rock	Thermo-mechanical effects expected during the periglacial and glacial domains are neglected during the assessment period. Deformation in the intact rock, due to excavations, is included in stability modelling.
Ge06 Displacements along existing fractures	Neglected in ground water flow modelling. Influence on fracture geometry is negligible compared to the overall uncertainty and the simplifications of the fracture network in the models. Fracture displacement is part of the stability modelling that is performed.
Ge07 Fracturing	Neglected. The models assume an elastic rock block material. The existing fractures are assumed to dominate the groundwater flow.
Ge09 Erosion/sedimentation in fractures	Insignificant impact in temperate and periglacial domain, compared with the process actions during periods of glacial climate domain.
Ge10 Advective transport/mixing of dissolved species	Advective transport is handled in SR-PSU. It is included in the modelling, both explicitly in the transport equations for radionuclides and implicitly through stream-line, one dimensional modelling for the evolution of the groundwater composition.
Ge11 Diffusive transport in the rock mass	Diffusive exchange between the flow path and the surrounding stagnant water is included in the equations in the models.
Ge12 Speciation and sorption	Kd data, with uncertainty ranges, are assumed to be approximately valid, or conservative, for in-situ groundwater composition ranges. Different Kd values are given for different speciations as a result of different redox potential ranges, but the most conservative values are chosen.
Ge13 Reactions groundwater/rock matrix	Not deemed to lead to appreciable changes in rock matrix porosity or mineralogy. Indirectly considered by use of equilibrated groundwater compositions in the solute transport modelling. The fate of matrix minerals is not assessed in SR-PSU.
Ge14 Dissolution/precipitation of fracture-filling materials	Not accounted for in RN transport modelling. Included in the thermodynamic analysis of groundwater composition.
Ge15 Microbial processes	The microbial population is expected to remove oxygen in the post-closure phase and lead to anaerobic conditions. Following this, microbial activity is considered to be limited (inhospitable conditions, high pH, low amounts of dissolved organic matter in geosphere) and to have a negligible influence on radionuclide transport.
Ge16 Degradation of grout	Degradation of the grout can affect the pH of the groundwater. However, the amount of cement in the waste and barrier system greatly exceeds that in the grout; hence, the grout is considered to have a negligible influence.
Ge17 Colloidal processes	Low concentrations of colloids are expected; hence, the influence of colloids on radionuclide transport has been neglected in the main scenario.
Ge19 Methane hydrate formation	Neglected. Unfavourable conditions for formation of methane hydrates, hence not expected to be present.
Ge20 Salt exclusion	Neglected. No density-driven flow, low initial salinities at depths above 200 m, not likely to be induced.
Ge21 Earth currents	Earth currents (from e.g. electrochemical reactions) are neglected. Surface conductivity effects are indirectly accounted for in assessing site-specific diffusivities. And there are no ore bodies found in the area (i.e. no potential electroferric content).
Ge22 Speciation of radionuclides	Pessimistic choice of parameters, analysis of sensitivity cases.
Ge23 Transport of radionuclides in the water phase	Included in radionuclide transport modelling. In some calculation cases, the transport resistance in the geosphere is not taken into account.
Ge24 Transport of radionuclides in the gas phase	The gas (mainly due to corrosion of steel in the waste) is assumed to escape through the geosphere, without any delay and without causing any damage.

## Biosphere

**Table F-10. Processes in the biosphere and handling in SR-PSU. The biosphere modelling includes a number of different modelling activities. The radionuclide model (described in Chapter 8) includes both radionuclide transport modelling and dose calculations. Hydrological modelling, landscape modelling and calculations of parameter values are supporting activities to the radionuclide modelling. Processes Bio11, Bio20, Bio23, Bio44 and Bio46 have been excluded since these are not important to consider for a low- and intermediate-level waste repository situated in the bedrock at Forsmark and hence do not need to be included in the safety assessment (SKB 2013c, 2014b).**

Process	Handling
Bio01 Bioturbation	Bioturbation is included in the radionuclide transport model, both in agricultural ecosystems where radionuclide inventories from upper regolith layers are initially mixed together in one biologically active cultivated layer, and via parameter values of bioturbation depths that are used to define the upper regolith layer in aquatic ecosystems.
Bio02 Consumption	Consumption is included in the radionuclide transport model and affects the flux from biota to regolith in the aquatic and terrestrial part of the radionuclide transport model. Consumption is also accounted for in dose calculations for humans and non-human biota. Ingrowth (a function of primary production of biomass that is indirectly affected by consumption, death and decomposition) in shallow bays and lakes is described in the landscape development model.
Bio03 Death	Death is included in the radionuclide transport model and affects the flux from biota to regolith in the aquatic and terrestrial part of the radionuclide transport model. Ingrowth in shallow bays and lakes is described in the landscape development model.
Bio04 Decomposition	Decomposition of organic matter is included in all organic regolith layers in the radionuclide transport model where flux from organic to inorganic compartments (mineralisation) are modeled). Ingrowth in shallow bays and lakes is described in the landscape development model.
Bio05 Excretion	Excretion affects the flux from biota to regolith in the aquatic and terrestrial part of the radionuclide transport model. Excretion is also considered in the calculation of parameter values for the radionuclide transport model and e.g. parameter values associated with uptake and excretion by biota (CR values and excretion or uptake of CO <sub>2</sub> ) are, to a high degree, based on site data. By using site data, the effects of excretion are assumed to be indirectly included in the parameter values.
Bio06 Food supply	Food supply (amount of available food) is considered in the dose calculations. Habitats providing food supply, as agricultural land, mires and lakes, are identified within the landscape model, and activity concentrations in the food items are calculated with the results from the radionuclide transport model.
Bio07 Growth	Growth is considered in the radionuclide model by use of landscape parameters, where ingrowth of reed is the first step of terrestrialisation of lakes and shallow bays. Growth of primary producers is also considered in the parameter <i>washoffCoeff</i> in the radionuclide model, which describes the loss (dilution) of intercepted elements due to processes such as growth.
Bio08 Habitat supply	The available habitat within biosphere objects is considered in the dose calculations for humans and non-human biota. Habitat supply is considered in the radionuclide transport model by applying landscape parameters (where different habitats are modelled) and ecosystem parameters (biomasses and production that are dependent on type of habitat).
Bio09 Intrusion	A well, which is drilled into the repository, is included in a specific Biosphere calculation case where ingestion of well water and dose from use of well water for irrigation are included in the dose calculations.
Bio10 Material supply	The amount of material available for human utilisation for purposes other than food is considered in the dose calculations where, for example, peat is used as biomass fuel, and seaweed and manure as fertilisers.
Bio12 Particle release/trapping	Particle release is included in the radionuclide transport modelling and affects the flux from biota to regolith in the aquatic and terrestrial part of the model. The particulate content of surface water and the atmosphere is considered in the radionuclide model by the use of parameters describing the composition of these media and this feature is affected by particle trapping and release by organisms.
Bio13 Primary production	Primary production, i.e. fixation of carbon is included in the radionuclide transport model as plant uptake. Net primary production also drives litter respiration/release and litter production, i.e. transport from primary producers to regolith layers in the radionuclide transport model. Primary production is included in landscape modelling and in ecosystem parameter calculations of production of edible food from different ecosystems.

<b>Process</b>	<b>Handling</b>
Bio14 Stimulation/inhibition	Biota may stimulate or inhibit each other, thereby affecting each other's biomass and production. Stimulation/inhibition is included in ecosystem parameter values used in the radionuclide transport model, e.g. the biomass and production values are based on site data where the effect of stimulation/inhibition is indirectly included.
Bio15 Uptake	In aquatic ecosystems, plant uptake of dissolved radionuclides from the surrounding water is included in the radionuclide transport model. In mire ecosystems, plant uptake of radionuclides from the upper soil layers (root uptake) and from the canopy atmosphere (through leaves) is included in the radionuclide model. Uptake of radionuclides is modelled by using element-specific CR values. In addition, uptake of radionuclides in water is considered for both humans and non-human biota in the dose assessment. Moreover, parameter values in the radionuclide model, affected by uptake and excretion by biota, are based to a high degree on site data and thereby also indirectly include these processes.
Bio16 Anthropogenic release	Anthropogenic release is included in the radionuclide transport model as a transfer from mires to agricultural land by fertilisation with organic fertilisers originating from hay and by irrigation with well water containing radionuclides.
Bio17 Material use	The use of manure and seaweed for fertilisation is considered in the radionuclide transport model. Burning biomass (peat and wood) for heating is included in the dose assessment for humans.
Bio18 Species introduction/ extermination	Species introduction is considered in the dose calculations. When mires are transformed to agricultural land, crops are introduced to the biosphere objects. It is also assumed that crayfish is introduced in the area in order to cautiously consider possible exposure pathways for humans from aquatic ecosystems.
Bio19 Water use	Water use by humans for purposes other than drinking (which is covered in uptake) could be e.g. irrigation. Irrigation of a garden plot is included in the radionuclide transport model and dose calculations.
Bio21 Consolidation	Compaction of regolith when mires are drained is included in the radionuclide transport model.
Bio22 Element supply	Element supply is not explicitly modelled in the radionuclide transport model but considered by the use of parameter values, e.g. element supply affects biomass and production parameters as well as site specific K <sub>d</sub> and CR values.
Bio24 Phase transitions	Phase transitions are considered in the radionuclide transport model in the exchange across the air/water interface.
Bio25 Physical properties change	Changes in physical properties are considered in the radionuclide transport model when mire regolith is drained and cultivated. In aquatic ecosystems, the properties of sediments change when marine basins are transformed into lakes.
Bio26 Reactions	Reactions lead to transfer of radionuclides from one media to another in the radionuclide transport model. The equilibrium concentration ratio between solid and liquid phases (K <sub>d</sub> ) and the concentration ratios between organisms and its surrounding media (CR) include outcome of chemical reactions. Equilibrium of CO <sub>2</sub> /HCO <sub>3</sub> <sup>-</sup> and H <sub>2</sub> CO <sub>3</sub> is explicitly included in the radionuclide transport model to estimate transfer of carbon-14 to the atmosphere.
Bio27 Sorption/desorption	Sorption leads to transfer of radionuclides from one media to another in the radionuclide model. Sorption is included by use of ecosystem-specific parameters (K <sub>d</sub> ). Sorption/desorption is also considered in the dose calculations for humans (e.g. sorption to skin) and to non-human biota by the use of CR values which take into account the sorption of radionuclides.
Bio28 Water supply	Water supply is considered in the dose calculations. The landscape modelling determines the location and volumes of lakes and streams in the area that can be used as water resources. Hydrological models evaluate whether surface water sources are sufficient for human needs and evaluate possible well locations for the hydrogeological modelling.
Bio29 Weathering	Weathering is considered in calculation of parameter values used in the radionuclide transport model. The dissolved inorganic carbon (DIC) concentration in the mire and the regolith is largely a result of chemical weathering of calcite, and since parameter values for DIC concentrations used are based on site data, this process is indirectly included. Weathering can also affect sorption/desorption processes, thereby affecting the empirical K <sub>d</sub> values.
Bio30 Wind stress	Wind stress is included in landscape and ecosystem parameters used in the radionuclide transport model, e.g. fetch (determined by wind stress) is a factor that determines where the accumulation of glacial and postglacial clay occur.
Bio31 Acceleration	Acceleration is included in the radionuclide transport model by the use of hydrological parameter values. In marine basins, water residence time is modelled based on the bathymetry of the basins at different times, which affect the speed of the water exchange.

<b>Process</b>	<b>Handling</b>
Bio32 Convection	Convective transport is modelled in the radionuclide transport model and also considered in several of the underlying models that result in parameter values to be used in the radionuclide model, e.g. most of the hydrological parameters describing water flows between regolith layers.
Bio33 Covering	Covering is included in the radionuclide transport model in the transition of lake to mire (ingrowth). The effect of covering is also considered in several of the underlying models resulting in parameter values for the radionuclide model, i.e. landscape modelling, hydrological modelling and ecosystem parameterisation (e.g. in parameters dependent on period of ice coverage).
Bio34 Deposition	Deposition includes both sedimentation and precipitation. Transport of radionuclides to sediment via sedimentation is included in the radionuclide transport model. The effect of sedimentation on the development of the landscape is included in landscape modelling, and the effect of precipitation on water fluxes in the area is included in hydrological modelling.
Bio35 Export	Export is included in the radionuclide transport model as fluxes out of the biosphere object via water and air. Export is also considered in underlying models (landscape modelling and hydrological modelling).
Bio36 Import	Imports are included in the radionuclide transport modelling as fluxes into the biosphere object via water and gas. Import is also considered in underlying models (landscape modelling and hydrological modelling).
Bio37 Interception	The effect of radionuclide retention on leaf surfaces due to intercepted irrigation water is included in the radionuclide transport model. Interception is also considered in hydrological modelling.
Bio38 Relocation	Relocation of organic matter via fertilisation is included in the radionuclide transport model. In the landscape modelling, relocation of sediment in marine basins is included.
Bio39 Resuspension	Resuspension of radionuclides from upper sediment to water is included in the radionuclide transport model. Resuspension is also included in the landscape modelling.
Bio40 Saturation	Saturation is included in the radionuclide transport model by the use of ecosystem parameters for agricultural soils (mires and aquatic ecosystems are assumed to be saturated). Saturation is also considered in the hydrological and landscape modelling.
Bio41 Radioactive decay	Radioactive decay and the ingrowth of progeny are included in all compartments of the radionuclide transport model.
Bio42 Exposure	Exposure of humans is accounted for in the dose calculations by a comprehensive set of exposure pathways, including both external and internal exposure. Exposure is calculated from the activity concentrations in foodstuffs and in environmental media modelled in the radionuclide transport model. Exposure of non-human biota is also included and calculated from activity concentrations in environmental media.
Bio43 Heat storage	Heat storage is not included in the radionuclide transport model but considered by the use of site-specific ecosystem parameters for aquatic and mire ecosystems. Heat storage dampens the effect of large temperature fluctuations in the air and affects, e.g. the abundance and type of biota.
Bio45 Light-related processes	Net primary production is dependent on light availability and since the ecosystem parameter values of primary production (used in the radionuclide transport model) are based on site data, the effects of light-related processes are considered.
Bio47 Radionuclide release	Radionuclide release is considered in the radionuclide transport model. The modelled release is assumed to enter the biosphere from the repository via the geosphere.
Bio48 Change in rock surface location	Change in rock surface location in combination with sea level change drives shoreline displacement. This is considered in the landscape modelling, and thereby in the parameters for the radionuclide transport model (e.g. altered geometries for each time step in the model). Change in rock surface location is also considered in the hydrological modelling.
Bio49 Sea level change	Sea level change in combination with change in rock surface location drives shoreline displacement. This is considered in the landscape modelling and hydrological modelling and result in parameter values for the radionuclide transport model, e.g. the parameter values describing the start and end of lake isolation.
Bio50 Thresholding	The occurrence and locations of topographical thresholds are accounted for in the landscape modelling which results in parameter values describing the timing of lake isolation, and locations of marine basins and lakes. Thresholding is also included in hydrological modelling.

**Table F-11. Assessment activities within SR-PSU, processes included in the assessment activities, background reports and computer codes.**

Assessment activity	Processes included in the assessment activity (see preceding tables)	Section in this report or reference to where the assessment activity is described	Background reports	Tool/Code	Input data from coupling no.* (see AMF)
<b>Assessment activities regarding the waste</b>					
Bitumen swelling pressures	WM16	Data/ Input data report	–	Judgement	126, 154
Concentration of complexing agents	WM03, 12, 15, 21 Pa08, 15 BMABa09, 18 BTFBa09, 17 SiBa10, SiBa25	6.3.7 and 8/9	Keith-Roach et al. 2014	Analytical solution	118, 132
Corrosion rates	WM18, 19 Pa12, 13 BMABA15, 16 BTFBa14, 15 SiBa22, SiBa23 BRTBa14, 15	6.3.7	<b>Data report</b>	Literature review	156, 206
Corrosion of reactor pressure vessels	WM18, 21 BRTBa17	8/9	<b>Radionuclide transport report</b>	Ecolego	120, 121, 122
Microbial activity	WM17, Pa11, BMABa14, BTFBa13, SiBa20, BLABa12, BRTBa13, Pg17	6.3.7	–	Judgement	133
Production of gas	WM19, Pa13, BMABa16, BTFBa15, SiBa23	6.3.7	Moreno and Neretnieks 2013	Analytical solution	33, 79, 94, 134
<b>Assessment activities regarding the near-field, excluding waste</b>					
Bitumen swelling assessment	WM09, WM16, Pa05, BMABa06, SiBa07	6.3.7	von Schenk and Bultmark 2014	Comsol Multiphysics	125, 137, 151
Concrete degradation due to sulphate attack	WM14, Pa10, BMABa12, BTFBa11, SiBa13, BRTBa11	6.3.8	–	Judgement	208
Evolution of bentonite barrier and plugs	SiBa02, Pg02	6.3.8, 6.4.8, 6.5.8	–	Judgement	41, 44, 205
Evolution of concrete barriers	See preceding activities in the AMF	6.3.8, 6.4.8, 6.5.8	–	Judgement	35, 36, 38, 209
Evolution of repository pH	WM08, 15, 18 Pa04, 12 BMABa04, 15 BTFBa04, 14 SiBa04, 22	6.3.7, 6.4.7	Cronstrand 2014	PhreeqC	175, 176, 177
Evolution of repository redox	WM15, 17, 18, 19 Pa12, Pa13 BMABa14, 15, 16 BTFBa13, 14, 15 SiSiBa22, SiBa23	6.3.7, 6.4.7, 6.5.7	Duro et al. 2012	PhreeqC	178, 179, 181
Freezing of bentonite	SiBa02, Pg02	6.5.8	–	Judgement	74, 185
Freezing of concrete	WM06, 09, 10, 21 Pa02, 05, 15 BMABa02, 18 BTFBa02, 17 SiBa02, 25 BRTBa02, 17	6.5.8	Thorsell 2013	Judgement	65, 140

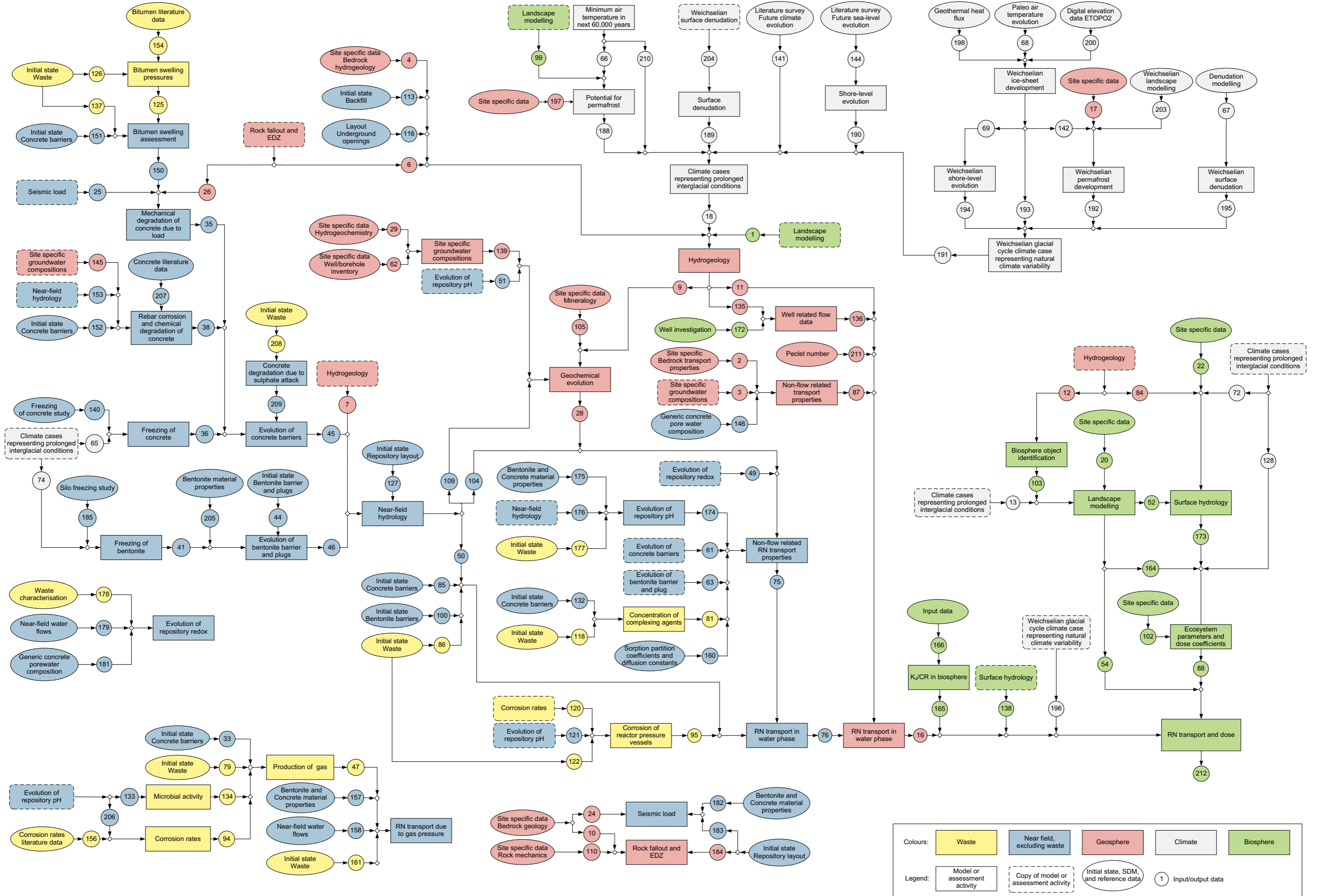
Assessment activity	Processes included in the assessment activity (see preceding tables)	Section in this report or reference to where the assessment activity is described	Background reports	Tool/Code	Input data from coupling no.* (see AMF)
Mechanical degradation of concrete due to load	See preceding assessment activity in the AMF	6.3.3	–	Judgement	25, 26, 150
Near-field hydrology	BMABa04, BTFBa04, SiBa04, BLABa04, BRTBa04	6.3.5, 6.4.5, 6.6.5	Abarca et al. 2013	Comsol Multiphysics	7, 45, 46, 127
Non-flow related RN transport properties	See preceding assessment activities in the AMF	<b>Data/ Input data report</b>	–	Judgement	28, 49, 61, 63, 81, 104, 160, 174
Rebar corrosion and chemical degradation of concrete	Pa05, 06, 07, 10 BMABa06, 07, 08, 12 BTFBa06, 07, 08, 11 SiBa07, 08, 09, 13	6.3.8, 6.4.8, 6.5.8	Höglund 2014	Phast	145, 152, 153, 207
RN transport due to gas pressure	WM19, 22 Pa13, 16 BMABa19 BTFBa05, 15, 18 SiBa05, 23, 26	8/9	Moreno and Neretnieks 2013	Analytical solution	47, 157, 158, 161
RN transport in water phase	WM21, Pa15, BMABa18, BTFBa17, SiBa25, BLABa15, BRTBa17 (These include sub-processes WM01, WM10, WM11, WM12, WM20...)	8/9	<b>Radionuclide transport report</b>	Ecolego	50, 75, 85, 86, 95, 100
Seismic load	LSGe02	Appendix D and 7/8	Georgiev 2013, <b>FEP-report</b>	ADINA	24, 182, 183
<b>Assessment activities regarding to the geosphere</b>					
Geochemical evolution	Ge10, Ge11, Ge13, Ge14	6.3.6, 6.4.6, 6.5.6	Auqué et al. 2013, Román-Ross et al. 2014	Judgement, FastReact	9, 51, 105, 109, 139
Hydrogeology	Ge03	6.3.4, 6.4.4, 6.5.4	Odén et al. 2014	Darcy Tools	1, 4, 6, 18, 113, 116
Non-flow related transport properties	Ge12, Ge22	Data/ Input data report	Crawford 2013	Judgement	2, 3, 146
RN transport in water phase	Ge23 (includes sub-processes)	8/9	<b>Radionuclide transport report</b>	Ecolego	11, 76, 87, 136, 211
Rock fallout and EDZ	Ge05, Ge06, Ge07	6.3.3	Mas Ivars et al. 2014	3DEC	10, 110, 184
Site specific groundwater compositions	Ge10	6.3.6, 6.4.6, 6.5.6	Auqué et al. 2013	Judgement	29, 62
Well related flow data	Ge03, Bio19, Bio28, Bio32	4.5.6, 6.3.1	Werner et al. 2014	Judgement	135, 172
<b>Assessment activities regarding to the biosphere</b>					
Biosphere object identification	Bio48, Bio49, Bio50	8.2.3	<b>Biosphere synthesis report</b> , Brydsten and Strömberg 2013	ArcGIS	12

Assessment activity	Processes included in the assessment activity (see preceding tables)	Section in this report or reference to where the assessment activity is described	Background reports	Tool/Code	Input data from coupling no.* (see AMF)
Ecosystem parameters and dose coefficients	Bio01, Bio02, Bio03, Bio04, Bio05, Bio06, Bio07, Bio08, Bio09, Bio10, Bio12, Bio13, Bio14, Bio15, Bio16, Bio17, Bio18, Bio19, Bio21, Bio22, Bio24, Bio25, Bio26, Bio28, Bio29, Bio30, Bio32, Bio33, Bio34, Bio37, Bio38, Bio39, Bio40, Bio41, Bio43, Bio45	4.5.3, 4.5.4, 4.5.5, 6.3.1, 6.4.1, 6.5.1, 8.2.3	Grolander 2013	Calculations of parameter values for Ecolego model	102, 128, 164, 173
K <sub>d</sub> /CR in biosphere	Bio05, Bio15, Bio22, Bio26, Bio27, Bio29	4.5.2, 8.3	Tröjlbom et al. 2013	Calculation of parameter values for Ecolego model	166
Landscape modelling	Bio02, Bio03, Bio04, Bio06, Bio07, Bio08, Bio10, Bio13, Bio14, Bio22, Bio28, Bio30, Bio33, Bio34, Bio35, Bio36, Bio38, Bio39, Bio40, Bio48, Bio49, Bio50	4.5.1, 6.3.1, 6.4.1, 6.5.1, 8.2.3	<b>Biosphere synthesis report</b> , Strömgren and Brydsten 2013, Brydsten and Strömgren 2013, Sohlenius et al. 2013a	ArcGIS	13, 20, 103
RN transport and dose	Bio01, Bio02, Bio03, Bio04, Bio05, Bio06, Bio08, Bio09, Bio10, Bio12, Bio13, Bio15, Bio16, Bio17, Bio18, Bio19, Bio21, Bio24, Bio25, Bio26, Bio27, Bio28, Bio32, Bio33, Bio34, Bio35, Bio36, Bio37, Bio38, Bio39, Bio41, Bio42, Bio47	8.2.3	<b>Biosphere synthesis report, Radionuclide transport report</b> , Saetre et al. 2013	Ecolego	16, 54, 88, 138, 165, 196
Surface hydrology	Bio24, Bio25, Bio28, Bio31, Bio32, Bio33, Bio34, Bio35, Bio36, Bio37, Bio40, Bio48, Bio49, Bio50	4.5.2, 6.3.1, 6.4.1, 6.5.1, 8.2.3	Werner et al. 2014	MIKE SHE	22, 52, 72, 84
<b>Assessment activities regarding to the climate</b>					
Climate cases representing prolonged interglacial conditions	Bio49, Ge01, Ge02, Ge03, Ge09, External processes, see <b>Climate report</b>	6.2	Brandefelt et al. 2013, <b>Climate report</b>	Judgement based on CCSM4, LOVECLIM, GIA model and 2D permafrost model, and, literature reviews	141, 188, 189, 190, 191, 210
Minimum air temperature in next 60,000 years	External processes, see <b>Climate report</b>	6.2	Brandefelt et al. 2013, <b>Climate report</b>	Judgement based on CCSM4, LOVECLIM and, literature reviews	None
Potential for permafrost	Ge01, Ge02, Ge03, Ge09, External processes, see <b>Climate report</b>	6.2	Brandefelt et al. 2013, <b>Climate report</b>	Judgement based on CCSM4, LOVECLIM, 2D permafrost model, and, literature reviews	66, 99, 197
Shore-level evolution	Bio49, External processes, see <b>Climate report</b>	6.2	<b>Climate report</b>	GIA model	144

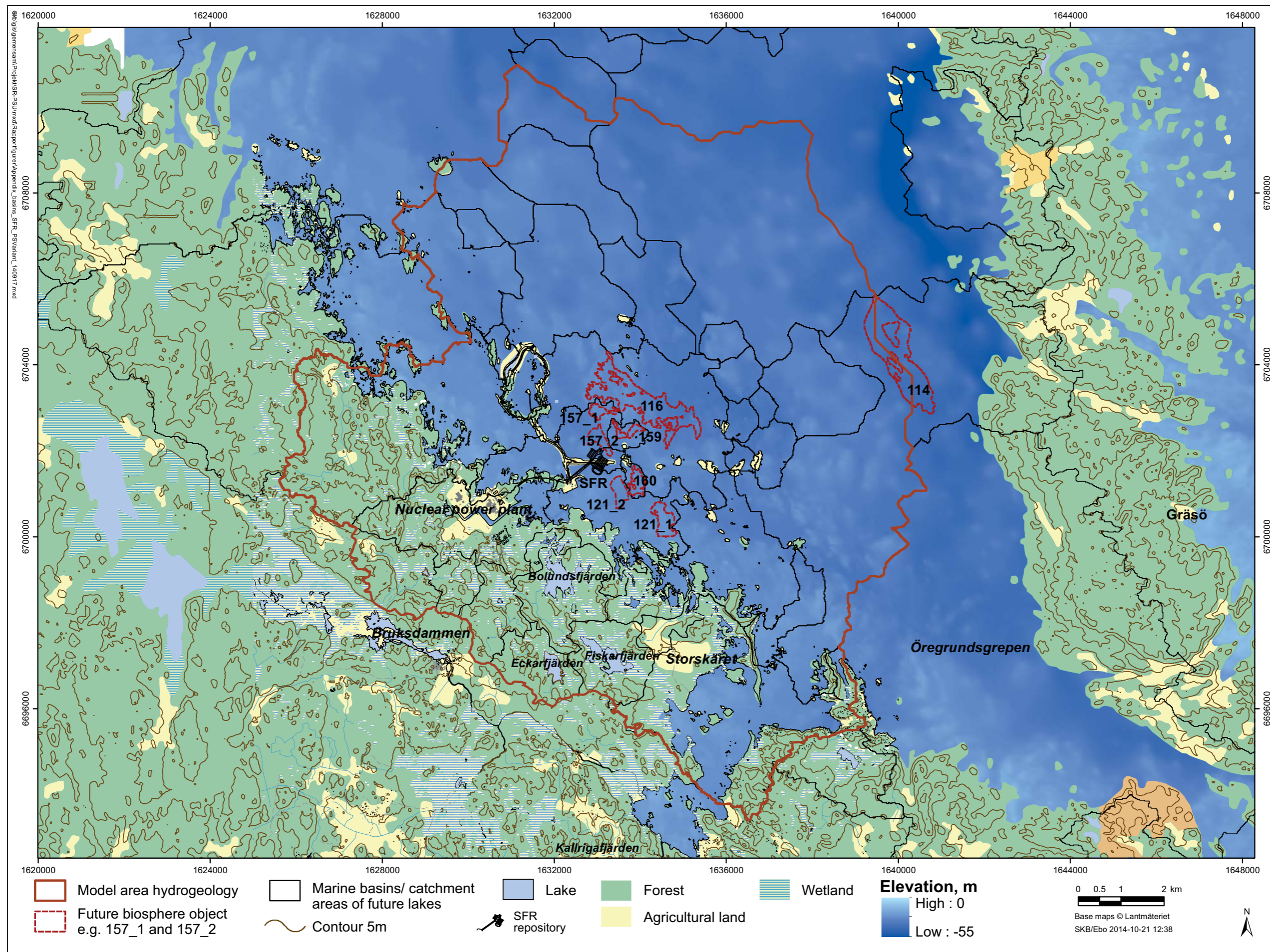
<b>Assessment activity</b>	<b>Processes included in the assessment activity (see preceding tables)</b>	<b>Section in this report or reference to where the assessment activity is described</b>	<b>Background reports</b>	<b>Tool/Code</b>	<b>Input data from coupling no.* (see AMF)</b>
Surface denudation	External processes, see <b>Climate report</b>	6.2	<b>Climate report</b>	Judgement	204
Weichselian glacial cycle climate case representing natural climate variability	Bio49, Ge01, Ge02, Ge03, Ge09, External processes, see <b>Climate report</b>	<b>Climate report</b>	Helmens 2013, Wohlfarth 2013, <b>Climate report</b>	Judgement based on GIA model, 2D permafrost model, paleo proxy data, and literature reviews	192, 193, 194, 195
Weichselian ice-sheet development	External processes, see <b>Climate report</b>	<b>Climate report</b>	<b>Climate report</b>	UMISM	68, 198, 200
Weichselian permafrost development	Ge01, Ge02, Ge03, Ge09, External processes, see <b>Climate report</b>	<b>Climate report</b>	<b>Climate report</b>	Judgement based on CCSM4, LOVECLIM and, literature reviews	17, 142, 203
Weichselian shore-level evolution	Bio49, External processes, see <b>Climate report</b>	<b>Climate report</b>	<b>Climate report</b>	GIA model	69
Weichselian surface denudation	External processes, see <b>Climate report</b>	<b>Climate report</b>	<b>Climate report</b>	Judgement	67

\* some numbers are missing, due to the fact that the AMF chart has been modified during the course of the work.











## Requirements on pH and the maximum amount of cellulose in the SFR repository

### I1 Impact of $^{14}\text{C}$ gaseous releases

Organic materials present in the waste can be degraded by microbial activity to produce hydrogen, methane, and carbon dioxide as gaseous products (**Waste process report**). Of these, carbon dioxide and methane may include  $^{14}\text{C}$ . Gases generated in SFR will initially dissolve in the water according to their solubility equilibria. If the solubility of the gas is exceeded, bubbles can form and create a discrete gas phase which can facilitate transport of gaseous radionuclides to the biosphere. The bulk  $^{14}\text{CO}_2$  will be removed due to carbonation of the cement present in the near-field. The  $^{14}\text{CH}_4$ , on the other hand, may reach the biosphere. In order to inhibit potential doses from  $^{14}\text{CH}_4$ , methane forming microorganisms must be minimised until a substantial portion of the  $^{14}\text{C}$  has decayed. It is not possible to create and guarantee a completely sterile environment, and therefore the conditions for methanogenesis must be controlled. This can be achieved by controlling pH in the waste vaults where  $^{14}\text{C}$  is abundant (the BTFs, BMA and the silo) over a sufficient period of time. Most of the  $^{14}\text{C}$  is contained in the ion exchangers as carbonate and to lesser extent as low molecular mass organic acids (LMMOAs) which are sorbed loosely to the resin via ion-ion interaction. Due to the hyperalkaline pH all the sorbed  $^{14}\text{C}$  compounds will be exchanged by OH-groups in the resin and therefore released into water either as carbonate or LMMOAs. These could potentially be used as a carbon source for microbes. However, since pH of this water is presumed to be hyperalkaline, i.e.  $>12.6$ , it is unlikely that methanogenes will be active.

Methanogenes are found in nearly every anaerobic environment. The methane forming microbes can respire across a wide environmental pH range from 4 to 10, although their optimum pH generally ranges from 6 to 8 (e.g. Ferry 1993). The potential methanogenesis is not likely to start until the pH has dropped below hyperalkaline values (Ferry 1993). In a recent study by Brazelton et al. (2013), they observed increased cell amounts up to a pH of 12.6, which is not the general case as more extreme conditions usually result in decreased activity (Pedersen et al. 2004). Although methanogenes are not active at these conditions these new findings indicate that more microbial studies in alkaline environment are needed. The knowledge of so called alkaliphiles is still very limited as there have been very few microbial studies done at close to hyperalkaline conditions. Further research is needed in order to better understand the pH dependence of methanogenesis and find out where the actual upper limit for active methanogenesis is. The pH in the waste vaults where  $^{14}\text{C}$  is abundant is required to be above 12.5 until a substantial portion of the  $^{14}\text{C}$  has decayed.

### I2 Impact of complexing agents formed from the degradation of cellulose

Under the conditions prevailing in most of the waste vaults, i.e. high pH and a  $\text{Ca}^{2+}$  rich environment, cellulose will degrade to shorter chained organic compounds. Of the compounds released in the degradation of cellulose, 3-deoxy-2-C-hydroxymethyl- D-erythro-pentonic acid ( $\alpha$ -ISA) and 3-deoxy-2-C-hydroxymethyl-D-threo-pentonic acid ( $\beta$ -ISA) are the most abundant. A greater proportion of ISA is formed from degradation carried out in the presence of calcium ions (Machell and Richards 1960). Further, among the degradation products of cellulose, ISA has been identified conclusively as a key component and one of the organic compounds with the greatest impact on the speciation and mobility of radionuclides in SFR formed from the degradation of cellulose. Therefore, ISA production in SFR must be controlled.

The rate of alkaline degradation is one of the factors determining the concentration of cellulose-derived complexants such as ISA in solution (Chambers et al. 2002, Askarieh et al. 2000). Recent experiments on cellulose degradation (Glaus and Van Loon 2008) were carried out under alkaline and aerobic conditions and at room temperature over a time span of 12 years. In view of the new data and the model presented in Glaus and Van Loon (2008), the range of uncertainty for complete degradation of cellulose under SFR conditions can be narrowed down to a best estimate of 1,000 to 5,000 years. Calculations based on the cellulose inventory in SFR suggest that all cellulose will be consumed within some 5,000 years after resaturation of the repository (Keith-Roach et al. 2014). Keith-Roach et al. (2014) further conclude that the concentration of ISA reaches concentrations where sorption is affected before all cellulose is degraded.

The preliminary waste acceptance criteria (SKBdoc 1368638) do not permit cellulose quantities in 2BMA and the silo to such an extent that sorption due to ISA formation is affected (Keith-Roach et al. 2014). For the other waste vaults the abundance of cellulose is not strictly regulated in the WAC but should be kept as low as possible. For 1 BMA the already deposited cellulose will give rise to ISA concentrations in such a range that sorption will be affected for a number of radionuclides. The amount of cellulose in all waste vaults will therefore most likely be regulated in the upcoming WAC.