

**International  
Progress Report**

**IPR-03-47**

**Äspö Hard Rock Laboratory**

**Status Report  
July - September 2003**

Svensk Kärnbränslehantering AB

December 2003

**Svensk Kärnbränslehantering AB**

Swedish Nuclear Fuel  
and Waste Management Co  
Box 5864  
SE-102 40 Stockholm Sweden  
Tel +46 8 459 84 00  
Fax +46 8 661 57 19



**Äspö Hard Rock  
Laboratory**

Report no.  
IPR-03-47

Author  
Karin Pers  
(comp.)

Checked by

Approved  
Christer Svemar

No.  
F50K  
Date  
Dec. 2003

Date

Date  
2003-12-05

# Äspö Hard Rock Laboratory

## Status Report July – September 2003

Svensk Kärnbränslehantering AB

December 2003

*Keywords:* Äspö HRL, Status Report

This report concerns a study which was conducted for SKB. The conclusions and viewpoints presented in the report are those of the author(s) and do not necessarily coincide with those of the client.

# Overview

The Äspö Hard Rock Laboratory (HRL) constitutes an important part of SKB's work to design and construct a deep geological repository for spent nuclear fuel and to develop and test methods for characterisation of a suitable site.

The plans for SKB's research and development of technique during the period 2002–2007 are presented in SKB's RD&D-Programme 2001 /SKB, 2001a/. The information given in the RD&D-Programme related to Äspö HRL is annually detailed in the Äspö HRL Planning Report /SKB, 2003/.

This Äspö HRL Status Report is a collection of the main achievements obtained during the third quarter 2003.

## **Technology**

One of the goals for Äspö HRL is to demonstrate technology for and function of important parts of the repository system. This implies translation of current scientific knowledge and state-of-the-art technology into engineering practice applicable in a real repository. A number of large-scale field experiments and supporting activities are therefore conducted at Äspö HRL: Canister Retrieval Test, Prototype Repository, Backfill and Plug Test, Long Term Test of Buffer Material, Cleaning and sealing of investigation boreholes, Low-pH cementitious products, KBS-3 method with horizontal emplacement, Large Scale Gas Injection Test, Temperature Buffer Test, New experimental sites, and Learning from experiences.

## **Geo-science**

Geo-scientific research is a natural part of the activities at Äspö HRL. Studies with the major aims to increase the understanding of the rock mass material properties and to increase the knowledge of measurements that can be used in site investigations are important activities: GeoMod Project, Rock stress measurements, Rock creep, Äspö Pillar Stability Experiment, Heat transport, Seismic influence on the groundwater system, and Inflow predictions.

## **Natural barriers**

Many experiments in Äspö HRL are related to the rock, its properties, and *in situ* environmental conditions. The goals are to increase the scientific knowledge of the safety margins of the deep repository and to provide data for performance and safety assessment. The experiments performed at conditions expected to prevail at repository depth are: Tracer Retention Understanding Experiments (TRUE Block Scale Continuation and TRUE-1 Continuation), Long Term Diffusion Experiment, Radionuclide Retention Experiments, Colloid Project, Microbe Project, and Matrix Fluid Chemistry.

Tests of models for groundwater flow, radionuclide migration and chemical/biological processes are one main purpose of the Äspö HRL. The major project is the Äspö Task Force on Modelling of Groundwater Flow and Transport of Solutes.

### ***Äspö facility***

An important part of the work at the Äspö facility is the administration, operation, and maintenance of instruments as well as development of investigation methods. Other issues are to keep the stationary hydro monitoring system (HMS) continuously available and to carry out the programme for monitoring of groundwater head and flow and the programme for monitoring of groundwater chemistry.

### ***International co-operation***

The Äspö HRL has so far attracted considerable international interest. Seven organisations from six countries participate during 2003 in the co-operation apart from SKB. In addition, SKB takes parts in several EC-projects and is through the Repository Technology department co-ordinating three EC-projects.



# Contents

<b>1</b>	<b>General</b> .....	<b>4</b>
<b>2</b>	<b>Technology</b> .....	<b>5</b>
2.1	Canister Retrieval Test .....	6
2.2	Prototype Repository .....	7
2.3	Backfill and Plug Test .....	8
2.4	Long Term Test of Buffer Material .....	10
2.5	Cleaning and sealing of investigation boreholes .....	11
2.6	Low-pH cementitious products .....	12
2.7	KBS-3 method with horizontal emplacement .....	13
2.8	Large Scale Gas Injection Test.....	15
2.9	Temperature Buffer Test.....	16
2.10	New experimental sites.....	18
2.11	Learning from experiences .....	19
2.12	Task Force on Engineered Barrier Systems .....	19
<b>3</b>	<b>Geo-science</b> .....	<b>20</b>
3.1	GeoMod Project.....	20
3.2	Rock stress measurements .....	21
3.3	Rock creep.....	21
3.4	Äspö Pillar Stability Experiment.....	22
3.5	Heat transport .....	24
3.6	Seismic influence on the groundwater system .....	24
3.7	Inflow predictions .....	25
<b>4</b>	<b>Natural barriers</b> .....	<b>26</b>
4.1	Tracer Retention Understanding Experiments.....	26
4.1.1	TRUE Block Scale Continuation .....	27
4.1.2	TRUE-1 Continuation .....	28
4.2	Long Term Diffusion Experiment .....	29
4.3	Radionuclide Retention Experiments.....	30
4.4	Colloid Project.....	32
4.5	Microbe Project.....	33
4.6	Matrix Fluid Chemistry .....	34
4.7	Task Force on Modelling of Groundwater Flow and Transport of Solutes.....	35
4.8	PADAMOT .....	37
<b>5</b>	<b>Äspö facility</b> .....	<b>38</b>
5.1	Facility operation.....	38
5.2	Hydro Monitoring System .....	39
5.3	Programme for monitoring of groundwater head and flow.....	39
5.4	Programme for monitoring of groundwater chemistry.....	40
<b>6</b>	<b>International co-operation</b> .....	<b>41</b>
<b>7</b>	<b>Documentation</b> .....	<b>43</b>
7.1	Äspö International Progress Reports.....	43
7.2	Technical Documents and International Technical Documents .....	44
<b>8</b>	<b>References</b> .....	<b>45</b>

# 1 General

The Äspö Hard Rock Laboratory (HRL) constitutes an important part of SKB's work to design and construct a deep geological repository for spent nuclear fuel and to develop and test methods for characterisation of a suitable site.

One of the fundamental reasons behind SKB's decision to construct an underground laboratory was to create an opportunity for research, development and demonstration in a realistic and undisturbed rock environment down to repository depth. The underground part of the laboratory consists of a tunnel from the Simpevarp peninsula to the southern part of Äspö where the tunnel continues in a spiral down to a depth of 460 m. The rock volume and the available underground excavations have to be divided between all the experiments performed at the Äspö HRL. In the figure below the allocation of the experimental sites in Äspö HRL are shown.

The Äspö HRL and the associated research, development, and demonstration tasks, managed by the Repository Technology Department within SKB, have so far attracted considerable international interest.

SKB's overall plans for research, development, and demonstration during the period 2002-2007 are presented in SKB's RD&D-Programme 2001 /SKB, 2001a/. The planned activities related to Äspö HRL are detailed on a yearly basis in the Äspö HRL Planning Report. The role of the Planning Report is also to present the background and objectives of each experiment and activity. This Status Report concentrates on the work in progress and refers to the Planning Report /SKB, 2003/ for more background information. The Annual Report will in detail present and summarise new findings and results obtained during the present year.

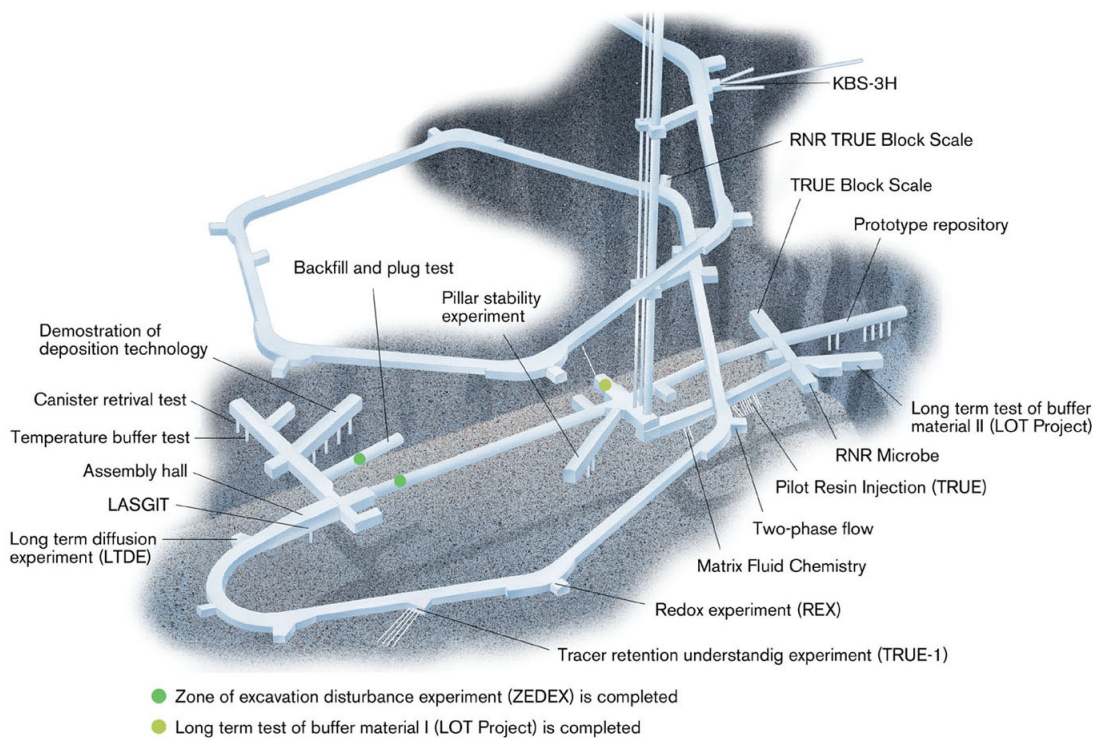

## 2 Technology

One of the goals for Äspö HRL is to demonstrate technology for and function of important parts of the repository system. This implies translation of current scientific knowledge and state-of-the-art technology into engineering practice applicable in a real repository.

It is important that development, testing and demonstration of methods and procedures, as well as testing and demonstration of repository system performance, are conducted under realistic conditions and at appropriate scale. A number of large-scale field experiments and supporting activities are therefore conducted at Äspö HRL. The experiments focus on different aspects of engineering technology and performance testing, and will together form a major experimental programme.





## 2.1 Canister Retrieval Test

---

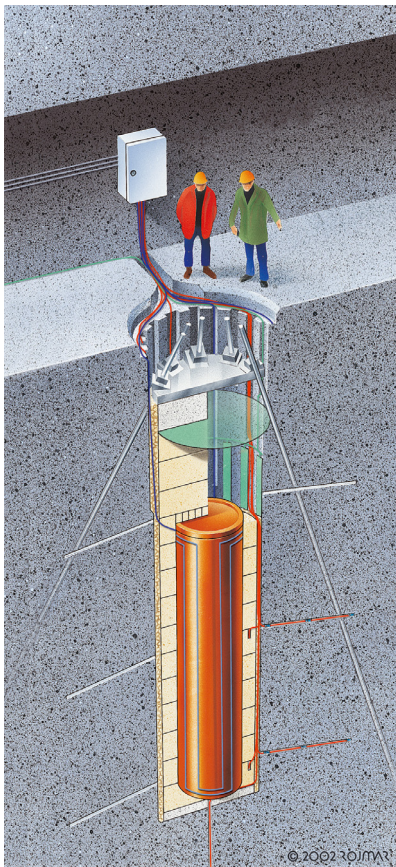

The Canister Retrieval Test is aiming at demonstrating the readiness for recovering of emplaced canisters also after the time when the bentonite is fully saturated.

In the Canister Retrieval Test two full-scale deposition holes have been drilled for the purpose of testing technology for retrieval of canisters after the buffer has become saturated.

These holes have been used for studies of the drilling process and the rock mechanical consequences of drilling the holes.

Canister and bentonite blocks were emplaced in one of the holes in 2000 and the hole was sealed with a plug, heater turned on and artificial water supply to saturate the buffer started.

The test has been running for almost three years with continuous measurements of the wetting process, temperature, stresses, and strains.

---

### **Achievements**

During the third quarter the artificial water supply to the bentonite has continued and the water pressure in the mats that distribute the water has been maintained at 800 kPa according to plan.

A large number of parameters are measured during the test to study the THM-processes and to provide a basis for e.g. modelling purposes. The transducers have been working well and the measurements and collection of data have continued during the third quarter. A data report covering the period up to 1<sup>st</sup> of May has been published /Goudarzi *et al.*, 2003/.

Large parts of the buffer between the canister and the rock are fully saturated although the saturation is rather uneven. Clogging of the filters in the mats is thought to be one of the reasons for the uneven saturation. The filters in the mats are therefore back-flushed at regular intervals.

Modelling of pressure, water content etc in the backfill during the saturation process is in progress. The predictions implied complete water saturation between the rock and the canister after about 2.5 years providing that free water was available along the entire rock surface.

A new project decision was approved the 30<sup>th</sup> of September, covering the period up to the end of 2006.

## 2.2 Prototype Repository

---



The Prototype Repository is located in the TBM-tunnel at the 450-m level and includes six full scale deposition holes.

The aims of the Prototype Repository are to demonstrate the integrated function of the repository components and to provide a full-scale reference for comparison with models and assumptions.

The Prototype Repository should, to the extent possible, simulate the real deep repository system regarding geometry, materials, and rock environment.

Instrumentation is used to monitor processes and properties in the canister, buffer material, backfill, and the near-field rock. The evolution will be followed for a long time.

---

### **Achievements**

The inner tunnel (Section I) was installed and the plug cast in 2001 and the heaters were turned on one by one. Since then the temperature, total pressure, pore water pressure, relative humidity and resistivity in buffer and backfill are measured and registered to study the ongoing THM-processes. In addition, temperature and water pressure are measured in boreholes in the rock around the tunnel.

The outer tunnel (Section II) is backfilled and the prefabricated wall at the end of the section was finalised in the end of June. During this quarter casting-pipes and flanges have been installed and the casting of the plug took place on September 11<sup>th</sup>. Finally, the casting-pipes will be sealed off by injection of epoxy. The instrument readings have been initiated and data from all sensors will be continuously measured and registered.

The measuring systems and transducers work well, but also during this period sensors have failed, and 73 out of 253 sensors in Section I (excluding water pressure sensors in the rock) are out of order, the majority (46) being RH-sensors that fail at water saturation. 19 out of 394 sensors in Section II (excluding water pressure sensors in the



rock) were out of order, on September 30<sup>th</sup> most of them due to problems with the data collection system. A new calibration of the fibre optic cables for temperature measurement on the surface of the canisters has been made but it is still preliminary, which means that adjustments of the results may be done afterwards.

The collected data show that the trends from the last report continue with a marked wetting going on in deposition hole 1, whereas the wetting in the holes 3, 5 and 6 is slow. Some wetting is taking place in the backfill and the wetting of the backfill seems to go fastest above hole 3. The maximum temperatures of the canisters differ, as expected. The design target was to reach a maximum of 90°C during saturated conditions, but three of the six canisters exhibit now a higher temperature than that. The approximate temperatures are: 76°C (No 1), 94°C (No 2), 99°C (No 3), 93°C (No 4), 84°C (No 5), and 86°C (No 6).

## 2.3 Backfill and Plug Test

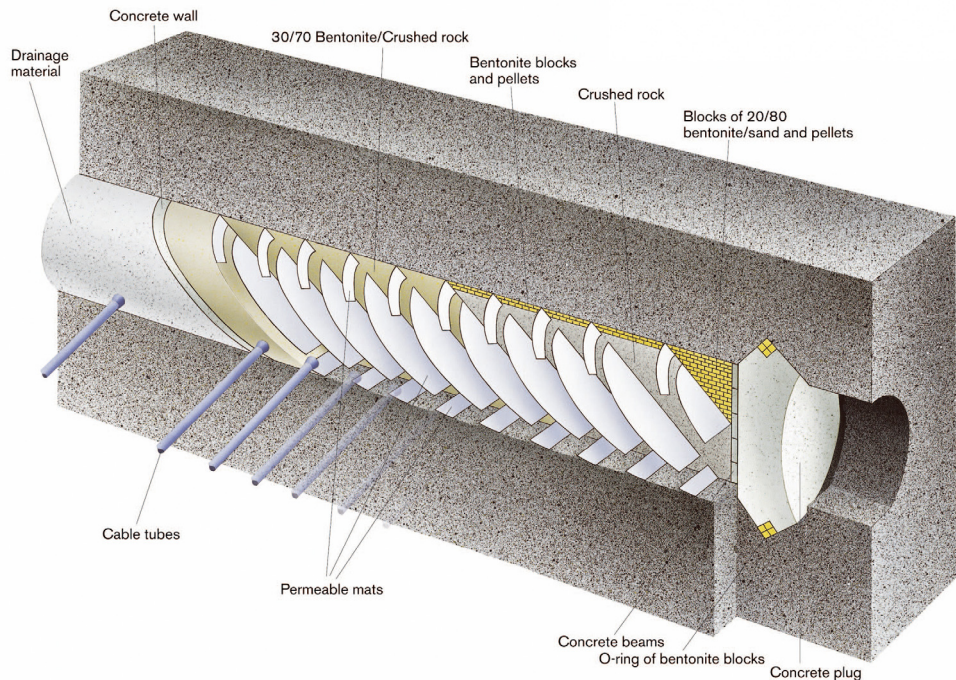

The Backfill and Plug Test includes tests of backfill materials and emplacement methods and a test of a full-scale plug. The inner part of the tunnel is filled with a mixture of bentonite and crushed rock (30/70) and the outer part is filled with crushed rock and bentonite blocks and pellets at the roof.

The integrated function of the backfill material and the near-field rock in a deposition tunnel

excavated by blasting is studied as well as the hydraulic and mechanical functions of the full-scale concrete plug.

The entire test set-up with backfill, instrumentation and casting of the plug was finished in the end of September 1999 and the wetting of the 30/70 mixture through the filter mats started in late 1999. Wetting of the backfill has continued since then.

## **Achievements**

Since the last quarter the water pressure in all filters has been kept constant at 500 kPa. Water saturation, water pressure and swelling pressure in the backfill and water pressure in the surrounding rock have been continuously measured and registered. The measurements show that the backfill is fully saturated (since the turn of the year 2002/2003). The water flow through the plug has decreased as a result of self-healing of fractures and is now around 0.02 litres per minute.

A decision was taken in March to shift to the next phase in the project, which means preparation for and implementation of flow tests. The strategy of the flow testing is in the first stage to successively decrease the water pressure in the mat sections (each section comprises three mats) starting with the mats at the plug. The pressure should be decreased in steps of 100 kPa and the hydraulic gradient kept for such long time that a steady flow could be observed. The water flow to and from the two mats sections surrounding the tested backfill section will be measured. Dams for additional measurements are installed in adjacent tunnels (TBM-tunnel and DEMO-tunnel). Conversion and adaptation of the flow system from wetting to flow testing has continued and been finalised during this quarter. The flow testing is now planned to start in the middle of October. Predictive modelling of the water flow in the backfill during the flow testing is in progress.

A new project decision was approved the 30<sup>th</sup> of September covering the period up to mid 2006.

## 2.4 Long Term Test of Buffer Material

---



The Long Term Test of Buffer Material aims to validate models and hypotheses concerning physical properties in a bentonite buffer.

Five 300 mm diameter test holes with a depth around 4 m have been drilled and instrumented. Five test parcels were installed in 1999. The intended test temperatures of 90°C and 130°C have been reached. In 2001 a one-year parcel was extracted from the rock by overlapping core drilling. The remaining four long-term test parcels are planned to run for at least five years.

The test parcels are also used to study related processes such as bentonite diffusion properties, microbiology, copper corrosion and gas transport in buffer material under conditions similar to those expected in a repository.

---

### **Achievements**

The analysing work and testing with material from the extracted one-year parcel A0 is completed. The compilation of results is in progress and a technical report will be issued.

There have been no new field activities during this period except control and calibration of the measuring equipment. The remaining four long-term test parcels have functioned well and temperature, total pressure, water pressure, and water content are continuously measured and registered every hour. The data are being checked monthly. The next extraction of a parcel is expected to take place in one and a half year.

Supporting experiments to examine the rate of copper corrosion in bentonite show a relative high copper corrosion rate of 4 µm/yr, which is an indication that aerobic conditions prevail. To complement the ongoing on-line copper corrosion measurements in the A2 parcel active copper corrosion measurements were made in September. The active measurements are performed by applying an external current to the copperplate inside the parcel. The results from these measurements are under evaluation.



## 2.5 Cleaning and sealing of investigation boreholes

---



A project, with the aim to identify and demonstrate the best available techniques for cleaning and sealing of investigation boreholes, was initiated in 2002.

The project comprises two phases. Phase 1 is mainly an inventory of available techniques, and Phase 2 aims to develop a complete cleaning and sealing concept and demonstrate it.

A laboratory test program on candidate sealing materials is part of the project. Short and long boreholes from the surface and from tunnels underground, will be used to demonstrate the plugging concept.

The project is run in co-operation between SKB and Posiva.

---

### **Achievements**

The first Phase of this project is now almost completed. A state of the art report summarising the developments of the sealing and cleaning techniques during the last 10–15 years has been published as an internal report (TD) titled “Borehole plugging – State of art”. The major conclusions were that smectite clay has been used successfully for borehole plugging and is recommended as main candidate material in the forthcoming work. Cement is concluded to serve less good, primarily because of questionable chemical stability.

The second phase of the project focuses on cleaning and sealing of boreholes. This phase will comprise three parts; (i) Completion of a borehole plugging concept (2003-2004), (ii) Laboratory tests (2003-2006), and (iii) Field tests (2004-2006).

During this quarter the main activities have been:

- Detailed planning of the second phase of the project.
- Initiated study on techniques for manufacturing perforated copper pipes, e.g. which components are available and what needs to be special manufactured.
- Collection of data on different boreholes (surface boreholes down to 700 m, surface borehole that ends in the Äspö tunnel, and horizontal boreholes with high water pressure in Äspö HRL) that can be used to test and demonstrate different sealing techniques.
- Studies of different techniques for stabilising the upper 50 meters of the boreholes that can withstand the pressure from potential ice loads e.g. sealing with drillcores and molten rock.

## 2.6 Low-pH cementitious products

---

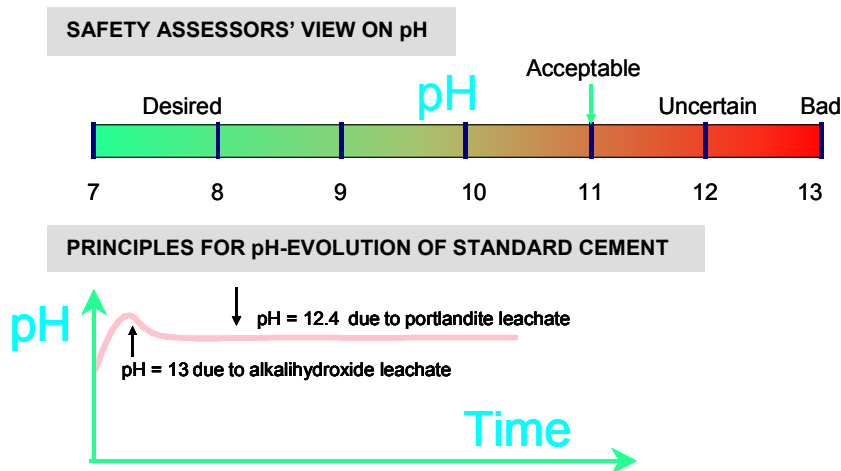

A project concerning the use of low-pH cementitious products in the deep repository started in 2001 as a co-operation between SKB, Posiva, and NUMO. The objectives of the project are to develop recipes for

cementitious products to be used as grouting and mortar for anchoring of rock bolts and to demonstrate the usage of these products in small field experiments in Äspö HRL.

---

### **Achievements**

The use of low-pH cementitious products is necessary in order to get leachates with a sufficiently low pH ( $\leq 11$ ). A pre-study was carried out in 2001, followed by a feasibility study in 2002 - mid 2003. The Feasibility study is reported both as a SKB working report and a Posiva R&D report /Bodén and Emmelin, 2003/. In the feasibility study a specific need for development of injection grouts both for larger and smaller fractures as well as testing them in field tests was identified.

In June 2003 a joint project "Injection grout for deep repositories" between Posiva, SKB and Nuclear Waste Management Organization of Japan (NUMO) was initiated. The current project aims at achieving some well quantified, tested and approved low-pH injection grouts. The project is divided into four sub-projects:

- Low-pH cementitious injection grout for larger fractures.
- Non-cementitious low-pH injection grout for smaller fractures.
- Field testing in Finland.
- Field testing in Sweden.

## 2.7 KBS-3 method with horizontal emplacement

---

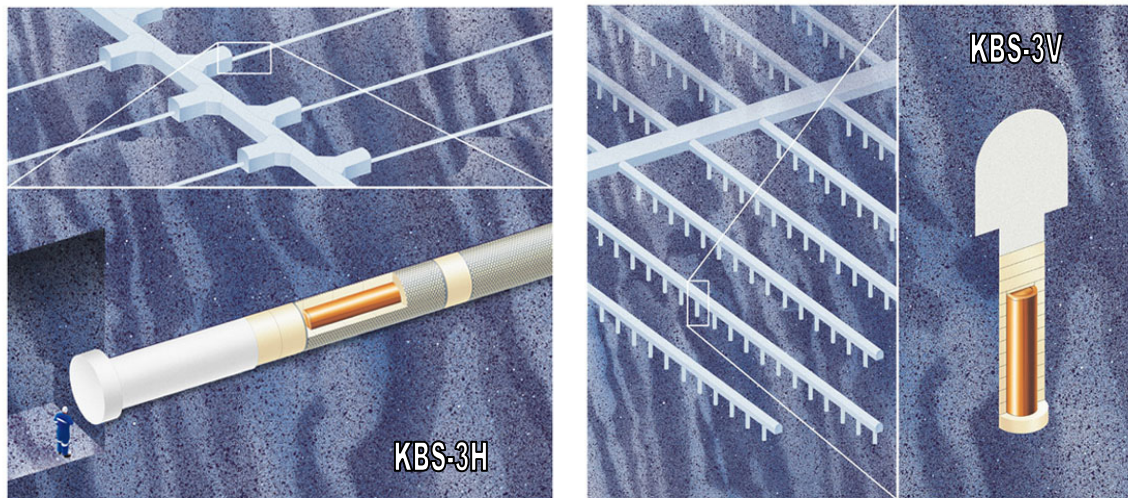

The possibility to modify the reference KBS-3 method and make serial deposition of canisters in long horizontal drifts (KBS-3H), instead of vertical deposition of single canisters in the deposition hole (KBS-3V), is studied in this project.

One reason for proposing the change is that the deposition tunnels are not needed if the canisters are disposed in horizontal drifts and the excavated rock volume and the amount of backfill can be considerably reduced.

Another reason is that it is easier to verify the quality of the near zone around the canister when the bentonite and the canister are assembled into a prefabricated disposal container in a reloading station.

---

### **Achievements**

A Feasibility Study was finalised in October 2002 and the SKB board decided in December 2002 to continue the project with the next phase. This phase comprise three main issues; (i) Development of equipment for construction of deposition drifts and handling of the disposal container, (ii) Barrier performance, and (iii) Demonstration in Äspö HRL.

On the initiative of Posiva an external review has been made by an expert group with participants from Nagra, NUMO and Enresa on the preliminary safety of the KBS-3 method with horizontal emplacement. The general conclusion from the expert group was that the method presents a viable technical solution.

A deposition container holding the copper canister and bentonite rings will be used for the emplacement in the horizontal drift. The total weight of the container and its contents is about 50 tonnes. Different techniques for heavy transports are available. A technique where the deposition container is riding on a water cushion has been found to be more advantageous than an air cushion. One reason is the lower heat evolution in the deposition container and its vicinity due to less energy required for transport with a water cushion.

The barrier performance is studied by Posiva and the reporting is in progress. Laboratory tests of the barrier performance are carried out by Clay Technology to study

occurrence of erosion and piping in the buffer as well as plugs for sealing. Tests performed on scale of 1:10 are finalised and under evaluation, and tests on scale of 1:1 have been initiated during this quarter.

The site for the demonstration of the method is located at 220 m depth in Äspö HRL. A niche, with a height of about 8 m and a bottom area of 15 x 15 m that will form the work area, has been excavated. Exploration drilling for two deposition drifts with a length of 30 m and one with length of 100 m is in progress. Cluster boring technique will be used for the boring of the deposition drifts. The design and construction of the boring equipment was done by Wassara AB. The equipment will be tested in Norway before the delivery to Äspö HRL.

## 2.8 Large Scale Gas Injection Test

---

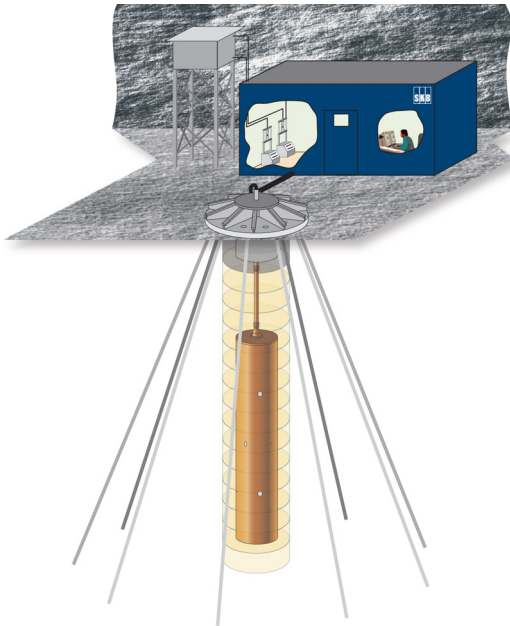

A full-scale canister (without heaters) and a bentonite buffer will be installed in an available bored deposition hole in Äspö HRL. Water will be artificially supplied to the buffer at isothermal conditions. When the buffer is fully saturated gas injection will start, first with small gas volumes and finally with volumes corresponding to gas formation from a defect full-size canister.

SKB has during several years performed a number of experiments with gas injection on MX-80 bentonite. Today, there is a relatively good understanding of the processes determining the gas transport. One remaining question is, however, the importance of the scale. All bentonite experiments so far have been performed in the centimetre scale and the extrapolation of the results from these experiments to repository scale is unclear. Therefore, the Large Scale Gas Injection Test (LASGIT) has been initiated.

The major aims of the project are to:

- Perform and evaluate full-scale gas injection tests based on the KBS-3 concept.
- Answer questions related to up-scaling.
- Get additional information on gas-transport processes.
- Obtain high quality data for testing and validation of models.
- Demonstrate that gas formation in a canister do not have obvious negative consequences for the repository barriers.

---

### **Achievements**

The planning of and the preparations for the installation of the test are in progress. The test will take place in an existing deposition hole (DA3147G01) in the TBM drift. The information available on the hole is sufficient and no new characterisation is planned.

The main activities during this quarter have been:

- Manufacturing of the bentonite blocks. The blocks have been manufactured in a hydrostatic well press (30 000 tonnes). The goal was to achieve a water saturation degree of 95 % in the rings (surrounding the canister) and 98 % in the cheeses (emplaced above and below the canister). The pressing was successful and resulted in 1 % higher water saturation degree in all blocks.
- Design and construction, by BGS Nottingham, of a measurement laboratory, to be hosted in the tunnel in a blue container.
- Manufacturing of instrumentation for the canister.
- Design of a lid for the upper part of the deposition hole. The lid will be very similar to the one used in the Temperature Buffer Test.
- Preliminary modelling of the saturation of the bentonite. This has been performed by Clay Technology to identify if some modifications of the experiment are required.



## 2.9 Temperature Buffer Test

---



The French organisation Andra carries out the Temperature Buffer Test (TBT) at Äspö HRL in co-operation with SKB. The variable nature of the French geological environment requires research to be carried out to relax the temperature constraints on the dimensioning of clay engineered barriers in order to produce more compact designs.

The aims of the TBT is to evaluate the benefits of extending the current understanding of the behaviour of engineered barriers to include high temperatures, above 100°C, and the experimental resources needed to achieve this. The test is located in the same test area as the Canister Retrieval Test, which is in the main test area at the 420-m level.

The TBT experiment includes two heaters in the axis of the deposition hole, one on top of the other, separated by a compacted bentonite block. They are 3 m long and 610 mm in diameter, and are constructed in carbon steel. Each one simulates a different type of confinement system: a bentonite buffer only (bottom section) and a bentonite buffer with inner sand backfill (upper section).

---

### **Achievements**

Two canisters with heaters, bentonite buffer, and sand infilling are installed in the deposition hole together with a system for artificial watering and a large number of sensors and cables for registration of e.g. saturation, pressures and temperatures (see Figure 2-1).

The operation of the test was initiated during the end of March 2003 with reduced heater effect. During this period the heater effect and the water supply have been increased in accordance with plan. The test is continuously monitored online of the test but some minor problems remain to be resolved before the system for direct distribution of data to Andra in France is up and running.

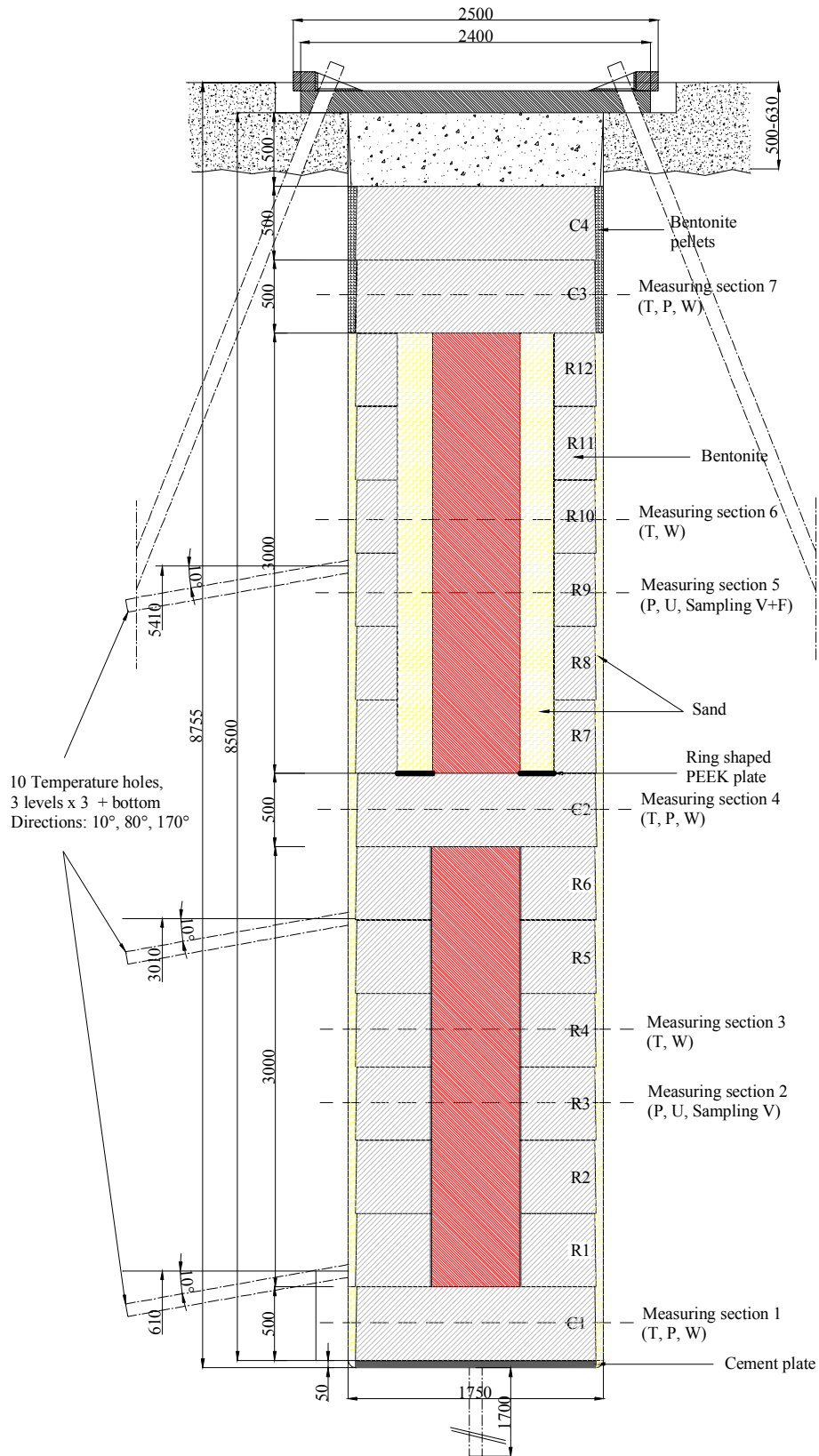

**Figure 2-1** Layout of the Temperature Buffer Test.

## **2.10 New experimental sites**

The major aims of this project have been to find new experimental sites at Äspö HRL for three large-scale experiments: Äspö Pillar Stability Experiment (APSE), Testing of low-pH grout, and KBS-3 method with horizontal emplacement (KBS-3H) and to carry through the necessary rock work for providing the tests with large enough openings. Another objective is to identify possible sites for two to three full scale deposition holes, which can be bored in conjunction with the boring of the two holes in the APSE project. No needs for these holes are presently identified, and the aim is to prepare for the future needs as new excavation will be prohibited for several years because of the impact this has on projects related to Natural barriers.

The use of explosives is known to cause disturbance in the hydraulic regime in the whole Äspö rock mass. However, the disturbances have been permanent only in very few cases. Another conflict with other experiments is that a penetration of a water-carrying fracture may change the hydraulic head in a large region around the place where the intersection takes place.

### ***Achievements***

Experimental sites were selected for APSE and the KBS-3H experiment during the first quarter 2003. The APSE site is located at the 450-m level and the KBS-3H site is located in a niche at the 220-m level. Testing of low pH grout can be made in existing tunnels or niches in the laboratory.

Most excavation work took place during the second quarter and the excavation work was finalised in July. During the excavation experiments dependent on a stable hydraulic environment were stopped and held on stand-by. An approximately 70 m long tunnel is excavated for APSE and a niche with an average height of 8 m and a bottom area of about 15 x 15 m is excavated for KBS-3H. From the niche the exploration drilling for the deposition drifts (in total 160 m) is going on. Two more holes are planned to be bored in conjunction with the APSE boring. One place is the APSE tunnel but in its beginning. This hole will be bored first, so it can serve as a test on the performance of the upgraded boring equipment. A second place is in the O-tunnel on 420-m level, which is close to the Canister Retrieval Test and Temperature Buffer Test sites.



## **2.11 Learning from experiences**

In this project, reference techniques for emplacement of buffer, canisters, backfilling, and closure are to be identified. Emplacement of buffer and canisters, and backfilling of tunnels have been experienced in Canister Retrieval Test, Prototype Repository and Backfill and Plug Test. These experiences are documented and the result analysed with respect to possible improvements as well as limits with respect to water inflows.

The work comprises:

- Compilation of the results from more than ten years of performed engineering experiments in Äspö HRL.
- Compilation and evaluation of experience from emplacement of buffer and canisters, backfilling of tunnels, and estimation of acceptable water inflows for the applied methods.

### ***Achievements***

A draft report that describes the large series of experiments related to engineered barrier systems that have been conducted in SKB's underground laboratories and construction sites during the time period 1981 to 2003 is available. The review of the draft report has been delayed. The report will be published as an IPR report in Äspö's report series.

## **2.12 Task Force on Engineered Barrier Systems**

The Task Force on Engineered Barrier Systems is still on stand-by while the prioritised work on modelling of THMC-processes in buffer during saturation is conducted on data from the Prototype Repository within the EC-project. The stand-by will last as long as the EC-project is operative, i.e. through the first quarter of 2004.

### ***Achievements***

A draft proposal has been compiled and distributed to the Äspö participants for an initial consultation on suitable direction and contents of the Task Force work.

### 3 Geo-science

Geo-scientific research is a natural part of the activities at Äspö HRL. Studies with the major aims to increase the understanding of the rock mass material properties and to increase the knowledge of measurements that can be used in site investigations are important activities.

#### 3.1 GeoMod Project

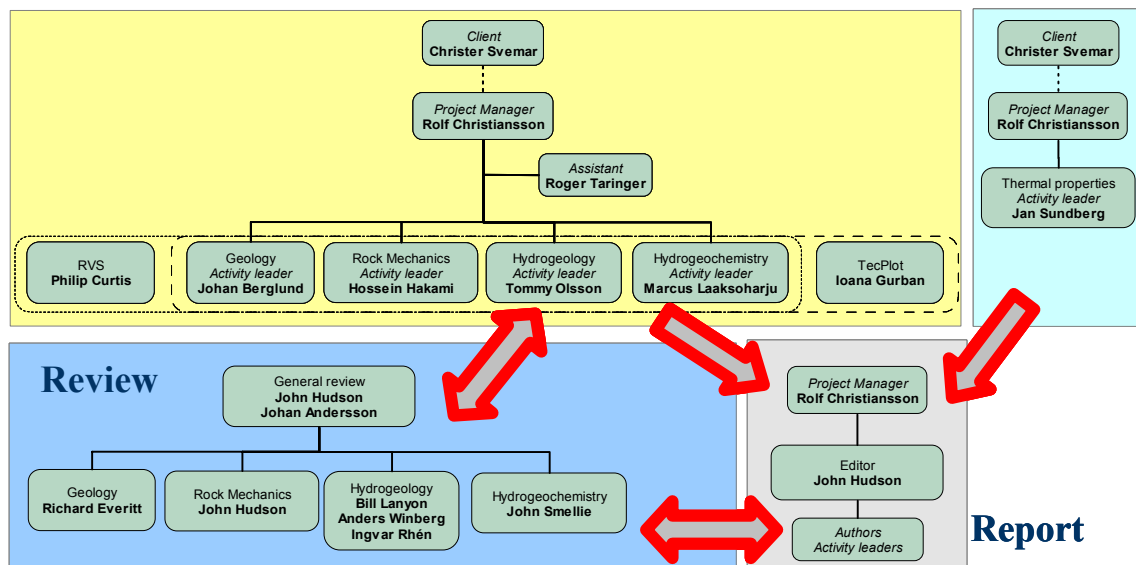

In the GeoMod project existing geological, geomechanical, hydrogeological and hydro-geochemical models of Äspö are updated by integration of data collected since 1995. A major part of the new data has been collected in the lower part of the Äspö HRL during the operational phase.

The updated models focus on a volume including the tunnel spiral volume from about 340 m down to about 500 m.

The project also aims to integrate the different geoscientific models. The development of a geothermal model is integrated in the project. This issue has earlier been run as a separate project.

#### Achievements

The models within each geo-scientific discipline have been assessed and results from the different projects conducted at Äspö has been utilised to modify or update the models. The reporting of the different geo-scientific disciplines is in progress and will be finalised before the outcome of 2003.

## **3.2 Rock stress measurements**

To be able to make correct assessments of the *in situ* stress field from results from different types of rock stress measurement techniques it is important to know the limitations and shortcomings of the different measurement techniques. Rock stress measurements with different techniques (bore probe, doorstopper and hydraulic fracturing) have during the years been performed as well as numerical modelling of the stress. The strategy for rock stress measurements will be presented in a report.

### ***Achievements***

A co-operation with Posiva with the objective to quality-assure overcoring data has been initiated. The first phase has been completed which includes development of a numerical tool for isotropic and elastic conditions.

SKB has contributed with seven articles to the special issue of the International Journal of Rock Mechanics and Mining Sciences where ISRM's suggested strategy for rock stress measurements will be presented.

## **3.3 Rock creep**

The aim with this project is to increase the understanding of the material properties of rock and rock-mass and to develop better conceptual models for the influence of the rock damaged zone and rock creep on rock stability.

A literature study and scoping numerical modelling with a three-dimensional coupled hydromechanical computer code (3DEC) have been performed. The results from the modelling and the literature study will be presented in a report.

### ***Achievements***

The literature study is under review.

### 3.4 Äspö Pillar Stability Experiment

---

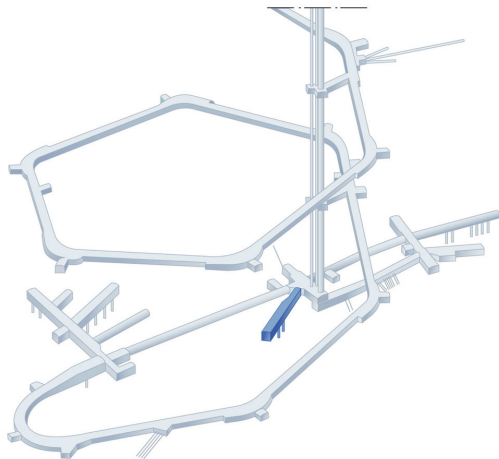

A Pillar Stability Experiment is in progress in Äspö HRL to complement an earlier study performed at URL in Canada. The major aims are to demonstrate the capability to predict spalling in fractured rock mass and the effect of backfill on the propagation of micro cracks. In addition, the capabilities of two- and three-dimensional mechanical and thermal predictions will be compared.

The pillar is created between two vertical deposition holes drilled in the floor of the

tunnel. The stress in the pillar will be further increased by a thermal load to reach a stress state that induces brittle failure and spalling.

A new drift has been excavated in Äspö HRL to ensure that the experiment is carried out in a rock mass with a virgin stress field. The site is located at the 450-m level. The arched drift bottom is designed to concentrate the stresses in the centre of the floor. The arched floor was excavated separately as a bench to minimize the excavation damaged zone in the floor.

The feasibility study of the experiment is presented by Andersson /2003/ and the general description of the experiment site is reported by Staub *et al.* /2003/ and Fransson /2003/. The preliminary modelling using general parameters has been finished and is presented in IPR-reports / Fredriksson *et al.*, 2003; Wanne and Johansson, 2003; Rinne *et al.*, 2003/.

#### **Achievements**

The excavation of the tunnel at the 450-m level was finalised in July. The blasting was successful and the rock mass damping of the blasting induced vibrations was much better than anticipated.

The position of the pillar has been determined and drilling of core boreholes for characterisation and installation of the instruments and heaters has been carried out. The monitoring programme for the displacements within the open hole during the heating phase of the experiment is finished. The general layout of the LVDTs for the displacement monitoring is presented in Figure 3-1.

Convergence measurements, giving excellent results, have been performed in one tunnel section (0/049). An article concerning this topic will be presented at the Sigma3 conference in Kumamoto, Japan in November 2003.

The laboratory tests on the drill cores from the core drilling of boreholes for instrumentation are available. The results, thermal and mechanical properties are within the intervals expected. These data will be used for final predictive modelling of the experiment.

The design of the liner, confining pressure in the backfill, has been modified and it has been installed and tested during two weeks in a borehole in Äspö HRL. The pressure in the liner has been decreased to 0.8 MPa compared to the originally planned 1.0 MPa. It is, however, judged that this decrease will not influence the experiment since the pressure was originally higher than sufficient.

The time table for the pillar experiment will be slightly delayed since it was decided to drill an additional large borehole in the tunnel for future needs.

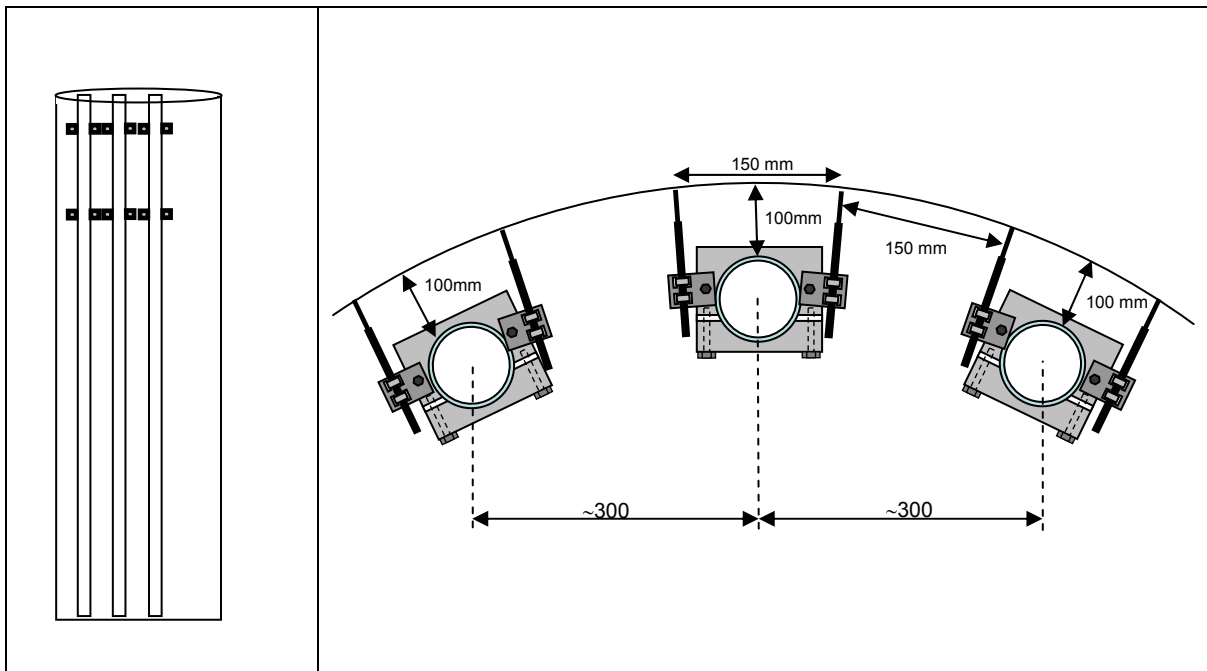

**Figure 3-1** To the left the, pipes in the borehole that the sensors will be mounted on. A crossbar will be installed on top of the pipes to stabilize them (not shown). The black boxes are the measuring sensors that are placed at two levels, 0.5 and 1.5 meters. The right picture shows the positioning of the pipes in the hole and the alignment of the sensors. Two layers of sensors will be installed at each level, which gives a total of twelve sensor positions.

### **3.5 Heat transport**

The aim with this project is to develop a strategy for site descriptive thermal modelling and to use the strategy to develop and test a thermal model for the Äspö Rock volume. The work includes measurements of thermal properties of the rock and examination of the distribution of thermal conductivities. Another aim is to analyse the thermal properties in different scales and clarify relevant scales for the thermal process by sensitivity analyses.

#### ***Achievements***

The model development strategy, the analysis of distribution and scaling factors and measured thermal properties at Äspö HRL are reported in three reports:

- Thermal Site Descriptive Model - A strategy for model development during site investigations /Sundberg, 2003a/.
- Thermal properties at Äspö HRL - Analysis of distribution and scale factors /Sundberg, 2003b/.
- Comparison of thermal properties measured with different methods (in press).

### **3.6 Seismic influence on the groundwater system**

The Hydro Monitoring System (HMS) registers at the moment the piezometric head in 409 positions underground in the Äspö HRL. An induced change of the head with more than 2 kPa triggers an intensive sampling. All measured data are stored in a database.

The data in the database are assumed to bear witness of different seismic activities in Sweden but also abroad, dependent on the magnitude of the event. By analysing the data on changes in the piezometric head at Äspö connections to specific seismic events are expected to be established.

#### ***Achievements***

Data from the HMS system are stored in the database pending analysis. A software is being developed that can search different databases for information with coupling to the registered events in the HMS system.

So far the software is able to scan HMS files in order to find anomalies in the data. The user can specify the desired criteria for the search; increased sampling rate, absolute trigger values and allowed derivate values. More advanced search criteria and data analysis is to be implemented in the future. The result of the search is presented in a txt-file and is sorted chronologically and by piezometric head.

Next step is to make a connection to the SKB's site characterisation database, SICADA for further characterisation. A connection to the HMS system for online searches is also being implemented.

### 3.7 Inflow predictions

SKB has conducted a number of large field tests where prediction of groundwater inflow into tunnels or depositions holes has been a component; the Site Characterisation and Validation Test in Stripa, the Prototype Repository and the Groundwater Degassing and Two-Phase Flow experiments in Äspö HRL. The results from these tests show that when going from a borehole to a larger diameter hole, the inflow into the larger hole is often less than predicted, and the explanation for this is not yet well understood.

The major objectives with this project are to make better predictions of the inflow of groundwater into deposition holes, to confirm (or refuse) previous observations of reduced inflow into deposition holes and tunnels compared with boreholes, and also to identify the different mechanisms determining the inflow and quantify their importance.

#### Achievements

Ongoing activities during this period have been numerical modelling. For this purpose the computer code 3DEC, which new version has the capability of performing fully coupled three-dimensional hydro-mechanical analyses, has been used. A generic study of the case of flow in a single fracture intersecting a deposition hole has been performed. In particular the influence of the fracture properties, such as stiffness and orientation, has been evaluated. The major conclusions from the so far is that the inflow will be much dependent on the fracture properties assumed. But also the bulk modulus of the water is an important factor when performing coupled analyses. Figure 3-2 shows, as an example of results, how far out from the deposition hole that there will be closure, due to the combined effect of rock stress increase and the lowered pore pressure around the excavation.

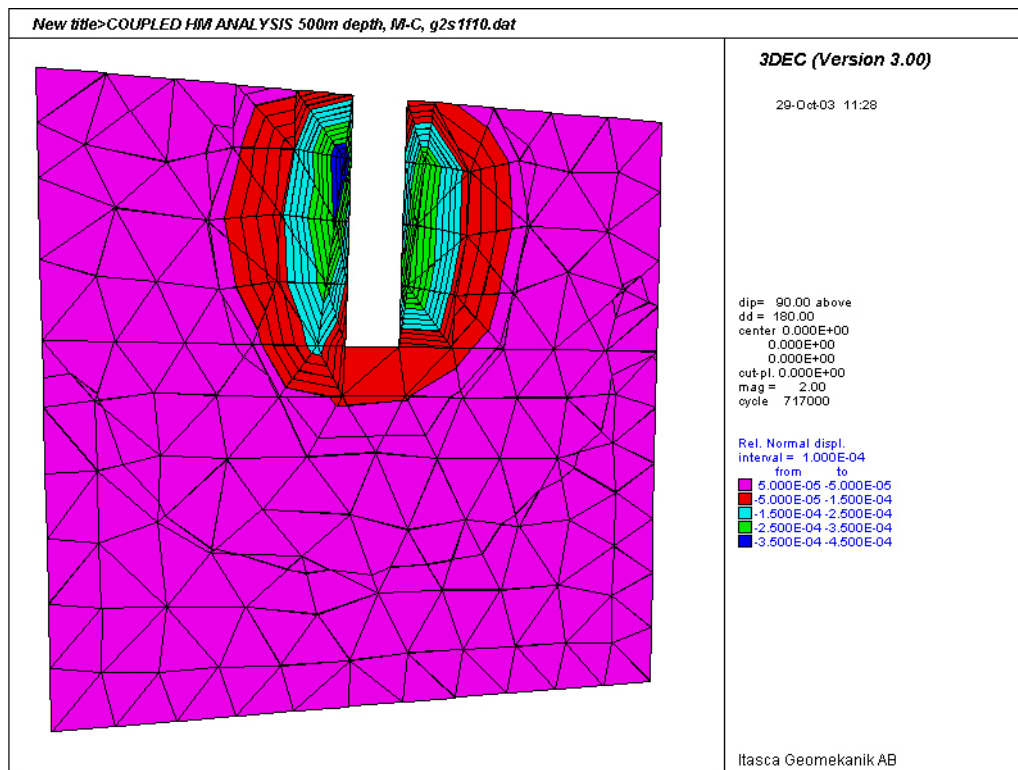

**Figure 3-2** Normal displacement contours around on the vertical fracture plane intersecting the deposition hole, once steady inflow has been reached ( $K=20$  GPa,  $K_s=12$  GPa, Friction angle=30, Dilation angle=0).

## 4 Natural barriers

At the Äspö HRL experiments are performed at conditions that are expected to prevail at repository depth. The experiments are related to the rock, its properties, and *in situ* environmental conditions. The goals are to increase the scientific knowledge of the safety margins of the deep repository and to provide data for performance and safety assessment and thereby clearly present the role of the geosphere for the barrier functions: isolation, retardation and dilution. Tests of models for groundwater flow, radionuclide migration and chemical/biological processes are one of the main purposes of the Äspö HRL. The programme includes projects with the aim to evaluate the usefulness and reliability of different models and to develop and test methods for determination of parameters required as input to the models.

### 4.1 Tracer Retention Understanding Experiments

---

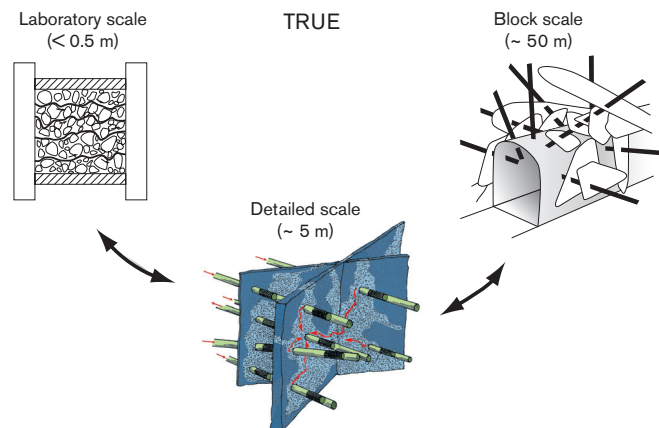

Tracer tests with non-sorbing and sorbing tracers are carried out in the TRUE family of projects. These are conducted at different scales; laboratory scale (< 0.5 m), detailed scale (<10 m) and block scale (up to 100 m) with the aim to improve understanding of transport and retention in fractured rock. The work includes building of hydrostructural models and conceptual microstructure models. Numerical models are used to assess the relative contribution of flow-field related effects and acting processes (diffusion and sorption) on *in situ* retention.

The first *in situ* experiment (TRUE-1) performed in the detailed scale and the TRUE Block Scale series of experiments have come to their respective conclusion and the evaluation and final reporting are completed. Complementary field work and modelling are currently performed as part of two separate but closely coordinated continuation projects.

The TRUE Block Scale Continuation project aims at obtaining additional understanding of the TRUE Block Scale site.

The TRUE-1 Continuation project is a continuation of the TRUE-1 experiment. According to present plans the TRUE-1 site will be injected with resin and excavated and analysed. The objectives are to obtain insight in the internal structure of the investigated feature and to study fixation of sorbing radioactive tracers.

Prior to the resin injection in Feature A complementary hydraulic and tracer tests are performed to better understand Feature A and its relation to the surrounding fracture network. In addition, a dress rehearsal of *in situ* resin injection is realised through a characterisation project focused on fault rock zones. Furthermore, attempts are made to assess fracture apertures using radon concentrations in groundwater.



#### 4.1.1 TRUE Block Scale Continuation

The objective of TRUE Block Scale Continuation (BS2) is to improve the understanding of transport pathways at the block scale, including assessment of effects of geometry, macrostructure, and microstructure, and the ability to predict retention using geological information. The project is focussed on the existing TRUE Block Scale site and it comprises two separate phases:

- BS2a Continuation of the TRUE Block Scale (Phase C). Pumping and sampling until the end of 2002 including employment of developed enrichment techniques to lower detection limits. Complementary modelling work to support the BS2b *in situ* tracer tests.
- BS2b *In situ* tracer tests based on the outcome of the BS2a analysis. *In situ* tests are preceded by reassessment of the need to optimise/remediate the piezometer array. The specific objectives of BS2b are to be formulated on the basis of the outcome of BS2a.

#### **Achievements**

An updated version of the RVS-model of the rock block has been constructed and the supporting modelling is near its conclusion. Draft reports are available from three modelling teams (on effects of heterogeneity along flow paths, variability of geometry and properties of fracture rim zones, usage of background fractures for *in situ* experimentation).

The possible path-ways for the tracers to be injected in the BS2b tests have been compiled. Based on this compilation model simulations of the network of long flow paths and background fractures for injection have been performed. Based on the simulations it was found that too long and too complex flow paths are not possible to test due to low mass recovery and too long test times. As a consequence, focus has been directed to Structure #19 and background fractures in its immediate vicinity. In order to cater for the planned tests involving Structure #19 a rearrangement of the multi-packer systems in boreholes KI0025F02 and KI0025F03 was performed during the summer and early fall. The pre-tests that precede planned tests with radioactive sorbing tracers comprise (i) short-time flow tests with a movable sink in borehole KI0025F02 and observations in nearby boreholes to investigate among other things the possibility to test a parallel (non-fault zone) structure denoted Structure #25, (ii) combined interference tests and tracer dilution tests involving sinks in Structure #19 in boreholes KI0025F, KI0025F02 and KI0025F03, and (iii) tracer tests with non-sorbing tracers. Results indicated that Structure #25 cannot be tested as an individual structure, but it may be possible to test it as a background fracture connected to the larger Structure #19. In addition, results of the interference tests identified Structure #19 in KI0025F03 as the most suitable sink.

#### **4.1.2 TRUE-1 Continuation**

The TRUE-1 Continuation project is a continuation of the TRUE-1 experiments, and the experimental focus is mainly on the TRUE-1 site, although work is also made at other locations at Äspö HRL. The main components of the test are: complementary *in situ* tests /Andersson *et al.*, 2002/, radon investigations /Byegård *et al.*, 2002 /, fault rock zone characterisation studies (including epoxy resin injection), and investigations in the laboratory of the sorption characteristics of rim zone and fault gouge material.

#### **Achievements**

The fault rock zone characterisation project includes injection of epoxy in a variety of structures of different dignity which all are characterised by fault rock zone. The injected sections are then over-cored and analysed for pore space. Four candidate sites have been selected for the injection test and 16 boreholes (76 mm), 3-6 m long, have been drilled at the selected sites. Epoxy has been injected in two boreholes (A02 and A04) at the length coordinate 1/596 m (zone NE-2) and preparations for injection of epoxy in the additional holes has been initiated, including flow measurements, injection of water and pressure measurements. In addition, material from one of the boreholes has been sampled for sorption measurements in the laboratory as part of the investigations concerning sorption characteristics of rim zone and fault gouge material.

## 4.2 Long Term Diffusion Experiment

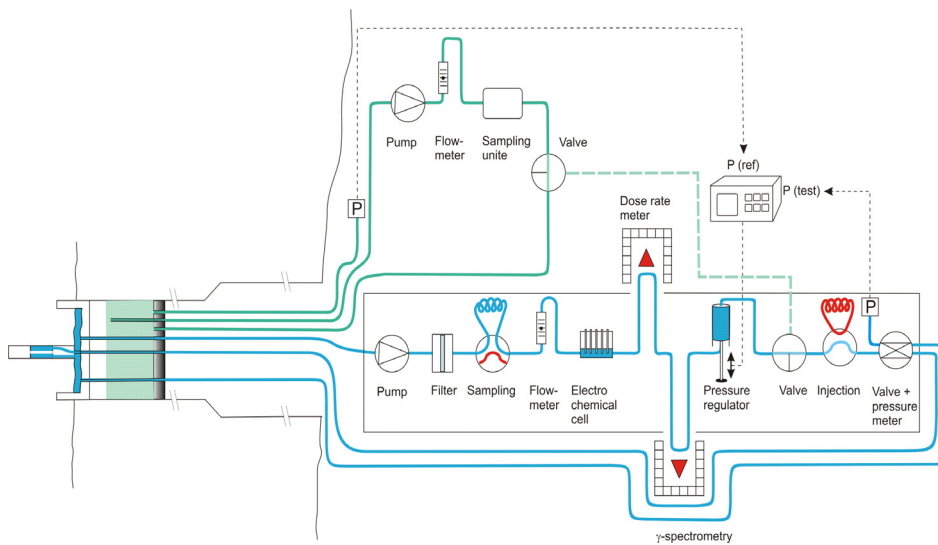

This experiment is performed to investigate diffusion and sorption of solutes in the vicinity of a natural fracture into the matrix rock and directly from a borehole into the matrix rock.

The aims are to improve the understanding of diffusion and sorption processes and to obtain diffusion and sorption data at *in situ* conditions. A core stub with a natural fracture

surface is isolated in the bottom of a large diameter telescoped borehole and a small-diameter borehole is drilled through the core stub and beyond into the intact unaltered bedrock. Tracers will be circulated over a period of three to four years after which the borehole is overcored and analysed for tracer content.

### Achievements

The installation phase of the project was resumed in September after an interruption during the tunnelling work at the APSE and KBS-3H sites. The installation was interrupted mainly to avoid disturbances from the excavation due to pressure variations and vibrations.

During this time period important experimental equipments, e.g. pumps and flow meters, that have corroded or been surface contaminated by the corrosion products have been cleaned or exchanged. Other activities in progress are the planning for the installation tests for the electrochemical flow cells as well as the detailed planning of the installation of the water circulation systems. In addition, a test was initiated to find out whether the microbes have been permanently removed from the borehole sections that have been rinsed by flowing water during a long time period. This test means that the borehole sections are isolated and the build-up of microbes is studied.

Since the planned tracer tests comprise radioactive tracers, SKB will apply for permission to carry out the experiment from the Swedish Radiation Protection Authority. The planning of radiological activities will take place when the permission has been issued and according to present plans the main experiments will start in the beginning of 2004.

The planning and lay-out of supporting laboratory experiments on drill cores to study diffusion and sorption of solutes is in progress. This work is done in co-operation with AECL.

## 4.3 Radionuclide Retention Experiments

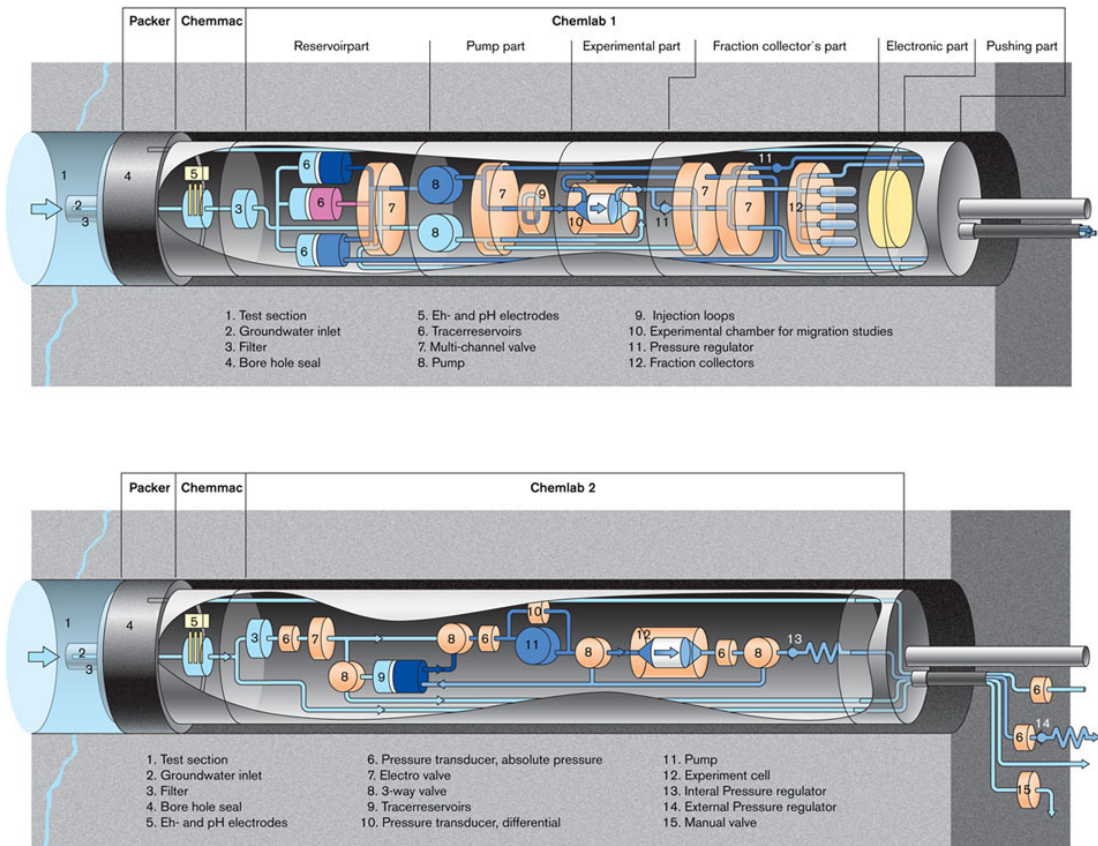

Radionuclide Retention Experiments are carried out with the aim to confirm results of laboratory studies *in situ*, where natural conditions prevail concerning e.g. contents of colloids, organic matter, and bacteria in the groundwater.

The experiments are carried out in special borehole laboratories, CHEMLAB 1 and CHEMLAB 2, designed for different kinds of *in situ* experiments. The laboratories are installed in long boreholes and experiments

can be carried out on bentonite samples and on tiny rock fractures in drill cores at *in situ* conditions.

The present focus is on:

- Radiolysis experiments in CHEMLAB 1, influence of radiolysis products on the migration of the redox-sensitive element technetium in bentonite.
- Migration of actinides in CHEMLAB 2, experiments with redox-sensitive actinides in a rock fracture.

### **Achievements – Radiolysis experiments**

In the end of 2002, two kinds of radiolysis experiments were started. In the indirect radiolysis experiments the groundwater is irradiated before it comes in contact with the experiment cell containing bentonite and reduced technetium. Radicals produced from water radiolysis will not reach the experiment cell, but the molecular products ( $\text{H}_2\text{O}_2$ ,  $\text{O}_2$ , and  $\text{H}_2$ ) will influence the redox chemistry in the cell. In the other type, direct radiolysis experiments, the irradiation source is placed in the experiment cell, close to the reduced technetium, and thereby the radicals produced may play a role.

The experiments have been analysed and the major conclusions are that technetium was to some extent oxidised in the direct radiolysis experiment and had started to diffuse whereas in the indirect radiolysis experiment technetium was only found in its reduced form. The so far obtained results bring about a need for additional analysis, e.g. the distribution of technetium in bentonite probes not influenced by radiolysis. A report will be published in December.

### **Achievements – Migration of actinides**

In these experiments a cocktail containing actinides is added to the groundwater before pumping it through a longitudinal natural fracture in a drill core placed in CHEMLAB 2. The first experiment comprised migration of the actinides: americium, neptunium, and plutonium. The second experiment was carried out in the beginning of 2002 and the results has been evaluated and published /Römer *et al.*, 2002/.

The third actinide experiment in Äspö HRL was started at the end of 2002. This experiment was expired due to several technical problems e.g. corrosion in the probe. The expired experiment provided, however, few water samples that have been analysed and evaluated by FZK/INE. These results will be published in a report. A preliminary version of this report is in progress.

The preparation of a fourth experiment is in progress. The drill core has been equilibrated with the groundwater at the site. The laboratory reservoir containing the tracer cocktail has been sent to Germany for preparation. According to present plans the experiment will be ran with radioactive isotopes (uranium, technetium, neptunium, plutonium, and americium). An application for a permit to perform the experiment will be given to the Swedish Radiation Protection Authority. The experiment is planned to be initiated in the beginning of 2004, presupposed that the preparatory work is successful.

## 4.4 Colloid Project

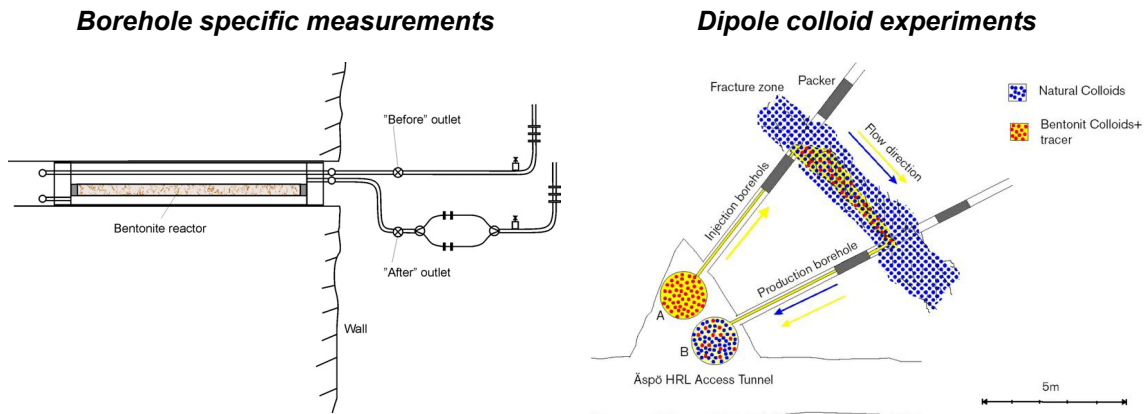

In the Colloid Project the concentration, stability, and mobility of colloids in the Äspö environment are studied. The project comprises studies of the potential of colloids to enhance solute transport and the potential of bentonite clay as a source for colloid generation.

The Colloid Project includes laboratory experiments, background measurements, borehole specific measurements, and dipole colloid experiments.

### **Achievements**

The laboratory experiments and the background measurements to study the occurrence of colloids in the groundwater has been published /Laaksoharju, 2003/.

The borehole specific measurements that were initiated in January, when six bentonite reactors were installed in four boreholes in the Äspö tunnel and in two boreholes at Olkiluoto, have all been finalised and evaluated. The reporting is in progress and the results from these measurements will be published in the final report for the borehole specific measurements, not as a basic report. In the experiments the groundwater is in contact with the bentonite clay adapted in the bentonite reactors in the boreholes and the colloid content in the water is measured prior and after it has been in contact with the bentonite clay. The colloid content is measured by using conventional filtering and ultra filtration. The colloid content was measured for the first time in February, the second measurements were performed in March, and the third and final measurements were carried out in April. The generation of colloids in the bentonite reactor was found to be very low.

The fracture dipole colloid experiments will be carried out in co-operation between SKB, INE and Posiva. Based on results from tests with conservative tracers, Feature B at the TRUE-1 site has been selected for the measurements.

## 4.5 Microbe Project

---



The Microbe Project has been initiated in the Äspö HRL for studies of the microbial activity in groundwater at *in situ* conditions. The major objectives are:

- To offer proper circumstances for research on the effect of microbial activity on the long- term chemical stability of the repository environment.
- To provide *in situ* conditions for the study of bio-mobilisation of radionuclides.
- To present a range of conditions relevant for the study of bio-immobilisation of radionuclides.
- To enable investigations of bio-corrosion of copper under conditions relevant for a high level radioactive waste repository.

The main MICROBE site is on the 450-m level where a laboratory container has been installed with laboratory benches, an anaerobic gas box and an advanced climate control system. Three core drilled holes, KJ0050F01, KJ0052F01 and KJ0052F03, intersecting water conducting fractures are connected to the MICROBE laboratory via tubings. Each borehole has been equipped with a circulation system offering a total of 500 cm<sup>2</sup> of test surface.

Retention of naturally occurring trace elements in the groundwater by Biological Iron Oxide is investigated at a site at tunnel length 2200A m. There is a vault with a borehole that delivers groundwater rich in ferrous iron and iron oxidising bacteria. The borehole is connected to two 200 x 30 x 20 cm artificial channels that mimic ditches in the tunnel. The channels have rock and artificial plastic support that stimulate Biological Iron Oxide formation.

At 907A m tunnel length, a small vault supports a ditch with groundwater that is rich in ferrous oxides and iron oxidising bacteria. This ditch is used as a natural analogue to the artificial channels at 2200A m.

A unique ecosystem of sulphur oxidising bacteria exists at tunnel length 1127B m, in the sulphur pond. Apart from being an intriguing site from a microbiological perspective, it also offers possibility to investigate microbial effects on the sulphur cycle in underground environments. It can be used to investigate microbial fractionation of sulphur isotopes and it will serve as an analogue for microbial influence on sulphur speciation in deep groundwater.

---

### **Achievements**

The laboratory container is in operation and the climate system functions as expected at the MICROBE 450-m site. Larger variations than expected of dissolved gas in the groundwater has been obtained, especially in the borehole (KJ0050F01) closest to the characterisation boreholes for the selection of the Äspö Pillar Stability Experiment site. It was therefore decided to interrupt the activities at the MICROBE site until the



excavations of new tunnels are completed and more stable conditions prevail in the rock.

Mark Nielsen, Oregon State University has performed research at the MICROBE 450-m site during a time period of six weeks (August 12 – September 20). He has studied the microbial activity as a function of additives of electron acceptors and donators.

## 4.6 Matrix Fluid Chemistry

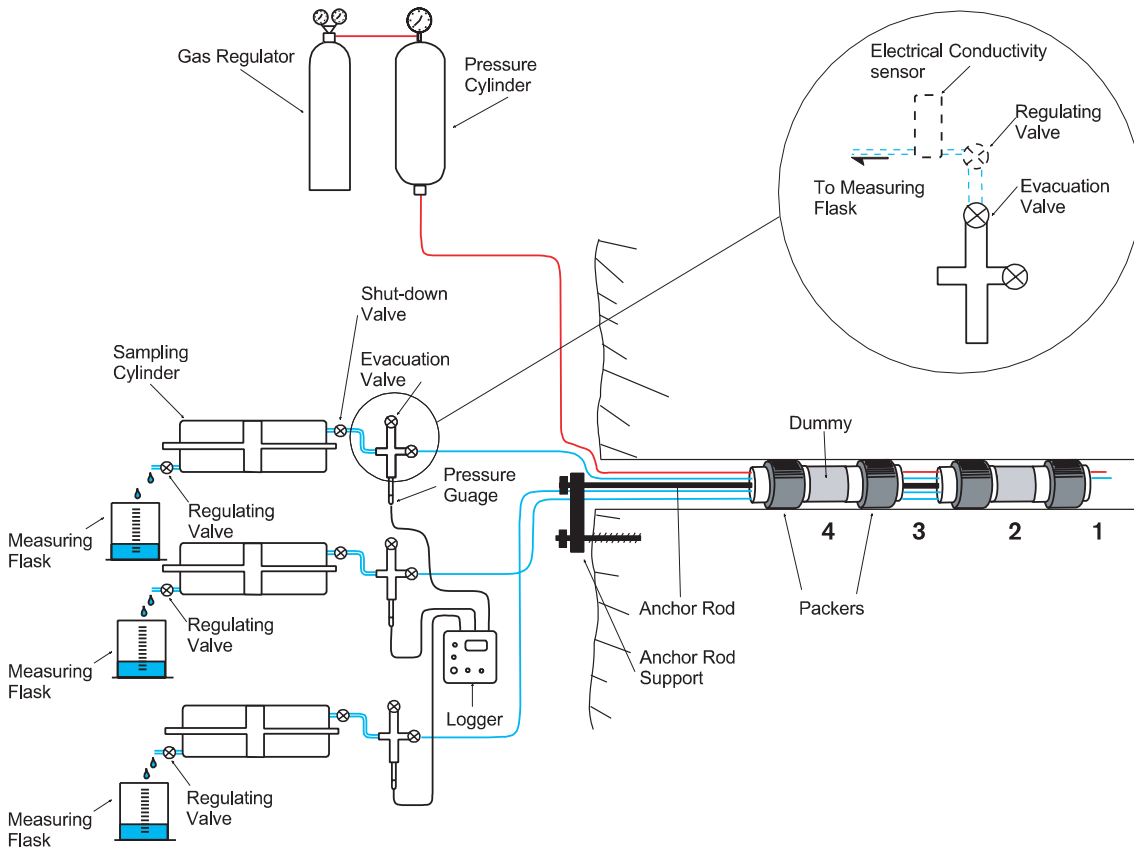

The main objectives of the Matrix Fluid Chemistry experiment are to understand the origin and age of fluids/groundwaters in the rock matrix pore space and in micro-fractures, and their possible influence on the chemistry of the groundwaters from the more highly permeable bedrock.

Matrix fluids are sampled from a borehole drilled into the rock matrix. Fluid inclusions in core samples have also been studied to determine their contribution, if any, to the composition of the matrix fluids/groundwaters.

### Achievements

The first part of the project has been reported in two internal international technical documents; the final write-up will be submitted for printing as a technical report in December. The major conclusion from this phase is that pore water can successfully be sampled from the rock matrix. The sampled matrix waters at approximately 450 m depth consisted dominantly of groundwaters relatively similar in major chemistry to more transmissive fractures in the surrounding bedrock environment. There was little evidence of draw-down effects and that the salinity of the matrix groundwaters has been influenced by fluid inclusions. This similarity in composition with the surrounding bedrock environment was unexpected but can be explained by the highly transmissive



nature of the Äspö site as a whole. In this respect Äspö is probably quite unique and other less transmissive sites would probably have given different results.

A new sampling of groundwater from the rock matrix borehole was initiated in February. The equipment was thereafter adjusted so that three microfractures (Features A, B and F) could be sampled. Because of time restrictions prior to tunnel excavation for the Äspö Pillar Stability Experiment, only very small quantities of water could be sampled from Features B and F, not enough for a quantitative characterisation. The analyses of gases sampled in April are in progress; gas analyses are presently in progress. A decision has to be taken during 2003 whether the experiment shall be continued or if influences from tunnel excavation will have proved to be detrimental.

#### **4.7 Task Force on Modelling of Groundwater Flow and Transport of Solutes**

---

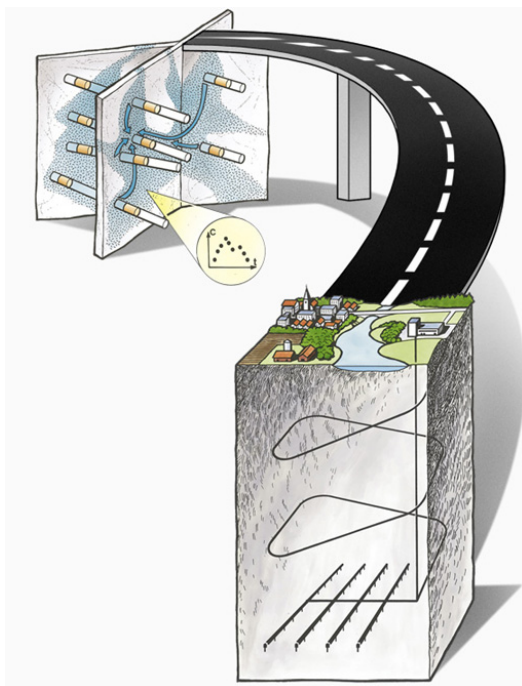

The Äspö Task Force on Modelling of Groundwater Flow and Transport of Solutes is a forum for the organisations supporting the Äspö HRL to interact in the area of conceptual and numerical modelling of groundwater flow and transport of solutes in fractured rock.

The Task Force shall propose, review, evaluate and contribute to the modelling work in the project. In addition, the Task Force shall interact with the principal investigators responsible for carrying out experimental and modelling works for Äspö HRL.

The work within the Äspö Task Force constitutes an important part of the international co-operation within the Äspö Hard Rock Laboratory.

---

#### **Achievements**

In the Task Force work activities have been in progress within the following tasks:

- Task 4 Tracer Retention and Understanding Experiment (TRUE), 1st stage.
- Task 5 Coupling between hydrochemistry and hydrogeology.
- Task 6 Performance Assessment Modelling Using Site Characterisation Data.

Task 4 was completed by the finalising of the overall evaluation of the modelling of the TRUE-1 tracer tests. The outcome of the evaluation is reported in /Marschall and Elert, 2003/. The modelling exercises within Task 5 have been completed.

Task 6 tries to bridge the gap between Performance Assessment (PA) and Site Characterisation (SC) models by applying both approaches for the same tracer experiment. It is hoped that this will help to identify the relevant conceptualisations (in processes/structures) for long-term PA predictions and identify site characterisation data

requirements to support PA calculations. The status of the specific modelling tasks is given in brackets in the table below. Recent activities in the Äspö Task Force are:

- A workshop on Task 6 was held at “Krägga Herrgård”, September 22-23, 2003. The aims of the workshop were to discuss the obtained results for sub-tasks 6A and B, and discuss how to proceed with sub-tasks 6D and E.
- The external review of Task 6 reports has been initiated by that the reviewers are familiarising themselves with the modelling work so far.
- Specifications of sub-task 6E have been sent out to the Task Force members.
- Minutes of the 17<sup>th</sup> Task Force Meeting at Äspö HRL have been distributed according send list. The writing of the proceedings from this Task Force Meeting has been ongoing during this quarter.

<b>Sub-task</b>	<b>Status</b>
6A	Model and reproduce selected TRUE-1 tests with a PA model and/or a SC model to provide a common reference. (Finalised, reported, and external review in progress).
6B	Model selected PA cases at the TRUE-1 site with new PA relevant (long term/base case) boundary conditions and temporal scales. This task serves as means to understand the differences between the use of SC-type and PA-type models, and the influence of various assumptions made for PA calculations for extrapolation in time. (Finalised, reported, and external review in progress).
6C	Develop semi-synthetic, fractured granite hydrostructural models. Two scales are supported (200 m block scale and 2000 m site-scale). The models are developed based on data from the Prototype Repository, TRUE Block Scale, TRUE-1, and Fracture Characterisation and Classification project (FCC). (Finalised and reported /Dershowitz <i>et al.</i> , 2003/).
6D	This sub-task is similar to sub-task 6A, and is using the synthetic structural model in addition to a 50 to 100 m scale TRUE-Block Scale tracer experiment. (In progress).
6E	This sub-task extends the sub-task 6D transport calculations to a reference set of PA time scales and boundary conditions. (Specifications sent out).

## 4.8 PADAMOT

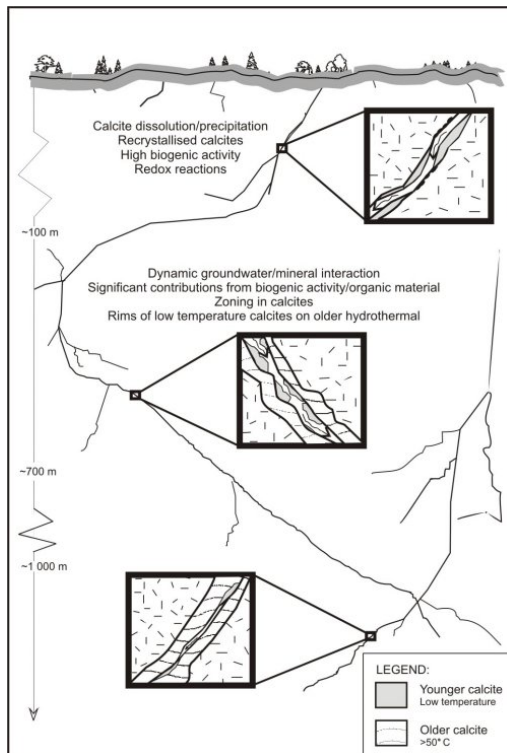

*Potential calcite-groundwater interaction at various depths at Äspö.*

PADAMOT (Palaeohydrogeological Data Analysis and Model Testing) will investigate changes in groundwater conditions as a result of changing climate. Because the long-term safety of an underground repository depends on the stability of the repository environment, demonstration that climatic impacts attenuate with depth is important. Currently, scenarios for groundwater evolution relating to climate changes are poorly constrained by data and process understanding.

The objectives of PADAMOT are to:

- Improve understanding and prioritise palaeohydrogeological information for use in safety assessments.
- Collect chemical/isotopic data using advanced analytical methods.
- Construct a database of relevant information and develop numerical models to test hypotheses.
- Integrate and synthesise results to constrain scenarios used in performance assessments.
- Disseminate the results to the scientific community.

The project comprises analytical and modelling tasks. Deep borehole cores from rocks at the Äspö Underground Laboratory and Laxemar (KXL01) are used in the analytical study.

### **Achievements**

Samples of fracture mineralization from sites in the United Kingdom, Sweden, Spain and the Czech Republic are being studied in the PADAMOT Project. Analysed drill cores from Laxemar (KLX01) had rather many fractures where the crystal morphology could be determined. The results were in good agreement with the earlier observed relations, from Sellafield, between water chemistry and calcite morphology. Calcite crystals developed in freshwater shows an equate morphology (short C-axes), whereas crystals developed in saline water shows a scalenoederic shape. The calcite crystal morphology in the surface fractures indicated the occurrence of meteoric water, which also a rather fractured section at 159 m did. The section in between indicated occurrence of saline water whereas the deep fractures (below 850 m) indicated that meteoric fresh water has reached this deep during some time period.

A number of samples (from KLX01) have been selected that will be analysed with respect to chemical zones and matrix water inclusions. Electron microscope images and cathodoluminescence images from a selected number of samples have been produced and based on this information a subset of samples have been selected for ion-probe ICP analyses of trace elements. These analyses have been performed and the results are being evaluated. Complementary analyses of stable isotopes ( $d^{18}O$  and  $d^{13}C$ ) will be performed for selected samples. The selection of samples for the complementary analyses was discussed in a workshop held in Edinburgh in August.

## 5 Äspö facility

An important part of the Äspö facility is the administration, operation, and maintenance of instruments as well as development of investigation methods. Other issues are to keep the stationary hydro monitoring system (HMS) continuously available and to carry out the programme for monitoring of groundwater head and flow and the programme for monitoring of groundwater chemistry.

### 5.1 Facility operation

---

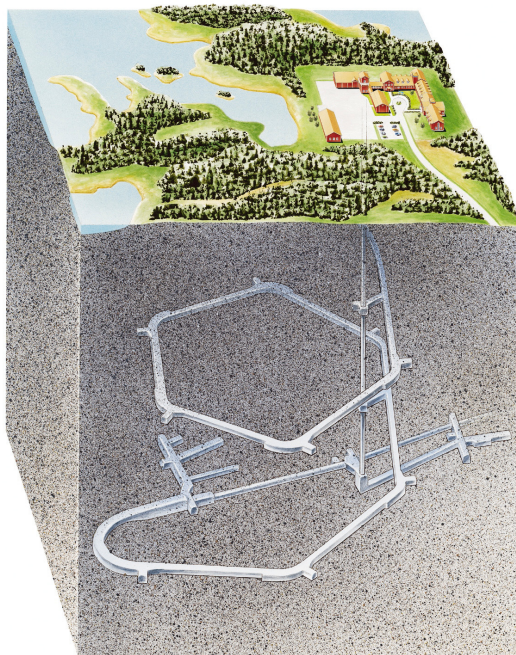

The main goal for the operation of the facility is to provide a safe and environmentally correct facility for everybody working or visiting the Äspö HRL.

This includes preventative and remedy maintenance in order to withhold high availability in all systems as drainage, electrical power, ventilation, alarm and communications in the Hard Rock Laboratory.

---

#### **Achievements**

Maintenance and operation of the above and underground facilities are running as well as improvements of the safety and working environment. The availability of the facility systems has continued to be high, 98% according to preliminary calculations, and the status of the facility is good. The planning of a rebuilding of the server-room is ongoing. This project is led by the IT-department but has several contact points with the operation of the facility, e.g. construction, ventilation and electricity.

The road improvements of “Kråkelundsvägen” are finalised. During the summer, the parking lot received a new pavement and the improved drainage.

The extensive power cut failure that took place 2003-09-23 in Sweden did not cause any damages to the facility. The loss of power lasted about 1.5 hours in the underground facility and about 4 hours above ground. The underground facility was supplied with electricity from the reserve generator at OKG and the cut off was therefore limited.

## **5.2 Hydro Monitoring System**

The Hydro Monitoring System (HMS) collects data on-line of groundwater head, salinity, electrical conductivity of the water in some borehole sections, and Eh and pH in other boreholes. The data are recorded by more than 400 transducers installed in boreholes on Äspö as well as in boreholes located in the tunnel. All data are transmitted to the main office at Äspö, by radio or modems. Weekly quality controls of preliminary groundwater head data are performed. Absolute calibration of data is performed three to four times annually. This work involves comparison with groundwater levels checked manually in percussion drilled boreholes and in core drilled boreholes, in connection with the calibration work.

### ***Achievements***

The excavation work performed in Äspö HRL during this summer caused interruptions in the data collection and disturbances of the HMS. The blasting resulted in increased groundwater pressure and caused failure in the instrumentation in 65 out of the about 250 measuring points in the underground facility. The HMS has been repaired and is now functioning well.

## **5.3 Programme for monitoring of groundwater head and flow**

The monitoring of water levels started in 1987 while the computerised HMS was introduced in 1992. The number of boreholes included in the network has gradually increased. The tunnel excavation started in October 1990 and the first pressure measurements from tunnel drilled boreholes were included in the HMS in March 1992.

To date the monitoring network comprises boreholes of which many are equipped with hydraulically inflatable packers, measuring the pressure by means of transducers. The measured data are relayed to a central computer situated at Äspö village through cables and radio-wave transmitters. Once a year the data are transferred to SKB's site characterisation database, SICADA. Manual levelling is also obtained from the surface boreholes on a regular basis. Water seeping through the tunnel walls is diverted to trenches and further to 21 weirs where the flow is measured. The scope of maintaining such a monitoring network has scientific as well as legal grounds.

### ***Achievements***

The monitoring points from the previous year have been maintained and no additional points are planned during 2003. The system will continue to support the experiments undertaken and meet the requirements stipulated by the water rights court.

## **5.4 Programme for monitoring of groundwater chemistry**

During the Construction Phase of the Äspö HRL, different types of water samples were collected and analysed with the purpose of monitoring the groundwater chemistry and its evolution as the construction proceeded. At the beginning of the Operational Phase, sampling was replaced by a groundwater chemistry monitoring programme, aiming at a sufficient cover of the hydrogeochemical conditions with respect to time and space within the Äspö HRL. This programme is designed to provide information to determine where, within the rock mass, the hydrogeochemical changes are taking place and at what time stationary conditions are established.

### ***Achievements***

The annual sampling campaign took place in September (week 38-39). Samples were taken from 2 surface boreholes (KAS), 30 sections in boreholes drilled from the tunnel, and 20 sampling points along the tunnel.

## 6 International co-operation

Seven organisations from six countries (see list below) are participating in the co-operation at Äspö HRL during 2003. Most of the organisations are interested in groundwater flow, radionuclide transport and rock characterisation. All organisations participate in the Äspö Task Force on Modelling of Groundwater Flow and Transport of Solutes, which is a forum for co-operation in the area of conceptual and numerical modelling of groundwater flow and solute transport in fractured rock.

<b>Projects in the Äspö HRL during 2003</b>	<b>Andra</b>	<b>BMWA</b>	<b>Enresa</b>	<b>JNC</b>	<b>Criepi</b>	<b>Nagra</b>	<b>Posiva</b>
<b>Technology</b>							
Prototype Repository (EC-project)	X	X	X	X	X		X
Backfill and Plug Test			X				
Long Term Test of Buffer Material							X
Low-pH cementitious products							X
KBS-3 method with horizontal emplacement							X
Large Scale Gas Injection Test							X
Temperature Buffer Test (Andra test)	X		X				
<b>Geo-science</b>							
Äspö Pillar Stability Experiment							X
<b>Natural barriers</b>							
Tracer Retention Understanding Experiments	X		X	X			X
Radionuclide Retention Project		X					
Colloid Project		X					X
Microbe Project		X					
Matrix Fluid Chemistry						X	
Task Force on Modelling of Groundwater Flow and Transport of Solutes	X	X	X	X	X	X	X

### Participating organisations:

Agence nationale pour la gestion des déchets radioactifs, Andra, France.

Bundesministerium für Wirtschaft und Arbeit, BMWA, Germany

Empresa Nacional de Residuos Radiactivos, Enresa, Spain

The Central Research Institute of the Electronic Power Industry, Criepi, Japan

Japan Nuclear Cycle Development Institute, JNC, Japan.

Nationale Genossenschaft für die Lagerung Radioaktiver Abfälle, Nagra, Switzerland

Posiva Oy, Finland.

## **Achievements**

Discussions with OPG, Canada have progressed and an agreement has been drafted based on the standard Äspö cooperation premises. The aim is to finalise the agreement so that it may come in force on January 1<sup>st</sup>, 2004.

## **EC-projects**

SKB is through Repository Technology co-ordinating three EC-contracts: Prototype Repository, Cluster Repository Project (CROP) and the project NET.EXCEL. SKB takes part in several EC-projects of which the representation is channelled through Repository Technology in five cases: FEBEX II, BENCHPAR, ECOCLAY II, SAFETI and PADAMOT.

---

**Prototype Repository** – Full scale testing of the KBS-3 concept for high-level radioactive waste (2000-09-01 – 2004-02-29)

Co-ordinator: Swedish Nuclear Fuel and Waste Management Co, Sweden

Participating countries: Finland, Germany, Japan, Spain, Sweden and United Kingdom

**CROP** – Cluster repository project, a basis for evaluating and developing concepts of final repositories for high level radioactive waste (2001-02-01 – 2004-01-31)

Co-ordinator: Swedish Nuclear Fuel and Waste Management Co, Sweden

Participating countries: Belgium, Canada, Finland, France, Germany, Spain, Sweden, Switzerland and USA

**FEBEX II** – Full-scale engineered barriers experiment in crystalline host rock phase II (1999-07-01 – 2004-10-31 after prolongation with 10 months)

Co-ordinator: Empresa Nacional de Residuos Radiactivos, Spain

Participating countries: Belgium, Czech Republic, Finland, France, Germany, Spain, Sweden, and Switzerland

**BENCHPAR** – Benchmark tests and guidance on coupled processes for performance assessment of nuclear repositories (2000-10-01 – 2003-09-30)

Co-ordinator: Royal Institute of Technology (Dep. of Civil and Environmental Engineering), Sweden

Participating countries: Finland, France, Spain, Sweden and United Kingdom

**ECOCLAY II** – Effects of cement on clay barrier performance, phase II (2000-10-01 – 2003-09-30)

Co-ordinator: National Radioactive Waste Management Agency of France

Participating countries: Belgium, Finland, France, Germany, Spain, Sweden, Switzerland and United Kingdom

**SAFETI** – Seismic validation of 3-D thermo-mechanical models for the prediction of the rock damage around radioactive spent fuel waste (2001-09-01 – 2004-09-01)

Co-ordinator: The University of Liverpool (Dep of Earth Sciences), United Kingdom

Participating countries: France, Sweden and United Kingdom

**PADAMOT** – Paleohydrogeological data analysis and model testing (2001-11-01 – 2004-11-01)

Co-ordinator: Nirex Ltd, United Kingdom

Participating countries: Czech Republic, Spain, Sweden and United Kingdom

**NET.EXCEL** – Network of excellence in nuclear waste management and disposal (2002-11-01–2004-01-31)

Co-ordinator: Swedish Nuclear Fuel and Waste Management Co, Sweden

Participating countries: Belgium, Finland, France, Germany, Spain, Sweden, Switzerland, and United Kingdom

---



## 7 Documentation

During the period July-September 2003, the following reports have been published and distributed.

### 7.1 Äspö International Progress Reports

**Collin M, Börgesson L, 2001.** Prototype Repository. Instrumentation of buffer and backfill for measuring THM processes.

IPR-02-03. Svensk Kärnbränslehantering AB

**Rachez X, Billaux D, 2002.** TRUE Block Scale project. Investigations of effect of structural model updates on response to simulated tracer tests.

IPR-02-26. Svensk Kärnbränslehantering AB

**Rhén I, Magnusson J, Forsmark T, 1998.** Äspö Task Force for modelling of groundwater flow and transport of solutes, Task 5. Data compilation: WP A3, WP A4.

IPR-02-57. Svensk Kärnbränslehantering AB

**Gurban I, Laaksoharju M, Andersson C, 1998.** Influences of the tunnel construction on the groundwater chemistry at Äspö. Hydrochemical initial and boundary conditions: WP D1, WP D2. Part 1.

IPR-02-58. Svensk Kärnbränslehantering AB

**Gurban I, Laaksoharju M, Andersson C, 1998.** Influences of the tunnel construction on the groundwater chemistry at Äspö. Hydrochemical initial and boundary conditions: WP D1, WP D2. Part 2.

IPR-02-59. Svensk Kärnbränslehantering AB

**Nilsson A-C, 1999.** Results of repeated tritium analyses. Performed during the winter 1998/1999 Äspö and Laxemar.

IPR-02-60. Svensk Kärnbränslehantering AB

**Doe T, 2002.** TRUE Block Scale Project. Generalized dimension analysis of build-up and pressure interference tests.

IPR-02-70. Svensk Kärnbränslehantering AB

**Holmqvist M, Andersson P, Byegård J, Trick T, Fierz T, Eichinger L, Scholits A, 2002.** TRUE Block Scale Project. Detailed characterisation stage. Test of new possible non-reactive tracers. Experimental description and evaluation.

IPR-02-71. Svensk Kärnbränslehantering AB

**Rinne M, Baotang S, Hee-Suk L, 2003.** Äspö Pillar Stability Experiment. Modelling of fracture stability by Fracod. Preliminary results.

IPR-03-05. Svensk Kärnbränslehantering AB

**Fransson Å, 2003.** Äspö Pillar Stability Experiment. Core boreholes KF0066A01, KF0069A01, KA3386A01 and KA3376B01: Hydrogeological characterization and pressure responses during drilling and testing.

IPR-03-06. Svensk Kärnbränslehantering AB

**Römer J, Kienzler B, Vejmelka P, Soballa E, Görtzen A, Fuss M, 2002.** Actinide migration experiment in the Äspö HRL, Sweden. Results of laboratory and in-situ experiments (Part II).

IPR-03-20. Svensk Kärnbränslehantering AB

**Rhén I, Forsmark T, Magnusson J, Alm P, 2003.** Prototype Repository.

Hydrogeological, hydrochemical, hydromechanical and temperature measurements in boreholes during the operation phase of the Prototype Repository Section II.

IPR-03-22. Svensk Kärnbränslehantering AB

**Pusch R, Svemar C, 2003.** Prototype Repository. Predictive modelling of EBS performance in the Prototype Repository Project.

IPR-03-26. Svensk Kärnbränslehantering AB

## **7.2 Technical Documents and International Technical Documents**

6 Technical Documents

No International Technical Document

## 8 References

- Andersson C, 2003.** Äspö Pillar Stability Experiment. Feasibility Study. IPR-03-01. Svensk Kärnbränslehantering AB
- Andersson P, Wass E, Gröhn S, Holmqvist M, 2002.** TRUE-1 Continuation Project. Complementary investigations at the TRUE-1 site – Crosshole interference, dilution and tracer tests, CX-1 - CX-5. IPR-02-47. Svensk Kärnbränslehantering AB
- Bodén A, Emmelin A (editors), 2003.** Djupförvar - Anläggningsutformning. Qualification of low-pH cementitious products in the deep repository. Results of the feasibility study. SKB Arbetsrapport TU-03-05/Posiva R&D Report 2003-01
- Byegård J, Ramebäck H, Widestrand H, 2002.** TRUE-1 Continuation Project. Use of radon concentrations for estimation of fracture apertures – Part 1: Some method developments, preliminary measurements and laboratory experiments. IPR-02-68. Svensk Kärnbränslehantering AB
- Dershowitz W, Winberg A, Hermansson J, Byegård J, Tullborg E-L, Andersson P, Mazurek M, 2003.** Äspö Hard Rock Laboratory. Äspö Task Force on modelling of groundwater flow and transport of solutes. Task 6c. A semi-synthetic model of block scale conductive structures at the Äspö HRL. IPR-03-13. Svensk Kärnbränslehantering AB
- Fransson Å, 2003.** Äspö Pillar Stability Experiment. Core boreholes KF0066A01, KF0069A01, KA3386A01 and KA3376B01: Hydrogeological characterization and pressure responses during drilling and testing. IPR-03-06. Svensk Kärnbränslehantering AB
- Fredriksson A, Staub I, Janson T, 2003.** Äspö Pillar Stability Experiment. Design of heaters and preliminary results from coupled 2D thermo-mechanical modelling. IPR-03-03. Svensk Kärnbränslehantering AB
- Goudarzi, R, Börgesson, L, Röshoff, K, Bono, N, 2003.** Canister Retirement Test. Sensors data report (Period 001026-030501) Report no: 6. IPR-03-30. Svensk Kärnbränslehantering AB
- Laaksoharju M (comp.), 2003.** Status report of the Colloid investigation conducted at the Äspö HRL during the years 2000-2003. IPR-03-38. Svensk Kärnbränslehantering AB
- Marschall P, Elert M, 2003.** Overall evaluation of the modelling of the TRUE-1 tracer tests - Task 4. The Äspö Task Force on Modelling of Groundwater Flow and Transport of Solutes. TR-03-12. Svensk Kärnbränslehantering AB
- Rinne M, Baotang S, Hee-Suk L, 2003.** Äspö Pillar Stability Experiment. Modelling of fracture stability by FRACOD. Preliminary results. IPR-03-05. Svensk Kärnbränslehantering AB

**Römer J, Kienzler B, Vejmelka P, Soballa E, Görtzen A, Fuss M, 2002.** Actinide Migration experiment in the HRL Äspö, Sweden: Results of laboratory and *in situ* experiments (Part II).

WB-FZKA 6770, October 2002, FZK-INE, Karlsruhe, Germany

**SKB, 2001a.** RD&D-Programme 2001. Programme for research, development and demonstration of methods for the management and disposal of nuclear waste.

TR-01-30. Svensk Kärnbränslehantering AB

**SKB, 2003.** Äspö Hard Rock Laboratory. Planning Report for 2003.

IPR-03-24. Svensk Kärnbränslehantering AB

**Staub I, Janson T, Fredriksson A, 2003.** Äspö Pillar Stability Experiment. Geology and properties of the rock mass around the experiment volume.

IPR-03-01. Svensk Kärnbränslehantering AB

**Sundberg J, 2003a.** Thermal Site Descriptive Model. A strategy for the model development during site investigations. Version 1.0.

R-03-10. Svensk Kärnbränslehantering AB

**Sundberg J, 2003b.** Thermal properties at Äspö HRL. Analysis of distribution and scale factors.

R-03-17. Svensk Kärnbränslehantering AB

**Wanne T, Johansson E, 2003.** Äspö Pillar Stability Experiment. Coupled 3D thermo-mechanical modelling. Preliminary results.

IPR-03-04. Svensk Kärnbränslehantering AB