

**International
Progress Report**

IPR-03-31

Äspö Hard Rock Laboratory

Prototype Repository

**Sensors data report
(Period 010917-030601)
Report No:6**

Compiled by

Reza Goudarzi

Lennart Börgesson

Clay Technology AB

June 2003

Svensk Kärnbränslehantering AB

Swedish Nuclear Fuel

and Waste Management Co

Box 5864

SE-102 40 Stockholm Sweden

Tel +46 8 459 84 00

Fax +46 8 661 57 19



**Äspö Hard Rock
Laboratory**

Report no.	No.
IPR-03-31	F63K
Author	Date
Reza Goudarzi	June 2003
Lennart Börgesson	
Checked by	Date
Approved	Date
Christer Svemar	2003-08-25

Äspö Hard Rock Laboratory

Prototype Repository

Sensors data report (Period 010917-030601) Report No:6

Compiled by

Reza Goudarzi
Lennart Börgesson

Clay Technology AB

June 2003

Keywords: Fields test, data, Prototype, bentonite, rock, canister measurements, water, pressure, total pressure, relative humidity, temperature, displacements, geoelectric

This report concerns a study which was conducted for SKB. The conclusions and viewpoints presented in the report are those of the author(s) and do not necessarily coincide with those of the client.

Abstract

This report presents data from measurements in the Prototype Repository during the period 010917-030601. The report is organized so that the actual measured results are shown in Appendix 1-7, where Appendix 5 deals with measurements of canister displacements (by AITEMIN), Appendix 6 deals with geo-electric measurements in the backfill (by GRS) and Appendix 7 deals with measurement of water pressure in the rock (by VBB/VIK). The main report and Appendix 1-4 deal with the rest of the measurements.

The following measurements are made in the bentonite in each of the two instrumented deposition holes (1 and 3): Temperature is measured in 32 points, total pressure in 27 points, pore water pressure in 14 points and relative humidity in 37 points. Temperature is also measured by all relative humidity gauges. Every measuring point is related to a local coordinate system in the deposition hole.

The following measurements are made in the backfill: Temperature is measured in 20 points, total pressure in 18 points, pore water pressure in 23 points and relative humidity in 45 points. Temperature is also measured by all relative humidity gauges. Furthermore, water content is measured by an electric chain in one section. Every measuring point is related to a local coordinate system in the tunnel.

The following measurements are made on the surface of the canisters: Temperature is measured every meter along two fiber optic cables. Furthermore, displacements of the canister in hole 3 are measured with 6 gauges.

The following measurements are made in the rock: Temperature is measured in 37 points in boreholes in the floor. Water pressure is measured in altogether 64 points in 17 boreholes all around the tunnel.

A general conclusion is that the measuring systems and transducers work well, but the number of sensors that has failed is increasing. 62 out of 253 sensors (excluding water pressure sensors in the rock) are out of order, the majority (33) being RH-sensors that fail at water saturation.

A new calibration of the fiber optic cables for temperature measurement on the surface of the canisters has been made but it is still preliminary, which means that adjustments of the results may be done afterwards.

The results show that the trends from the last report continue with a marked wetting going on in deposition hole 1, some wetting is taking place in the backfill, but the wetting in hole 3 is slow. The wetting of the backfill seems to go fastest above hole 3. The maximum temperature of the canisters differs substantially. It has raised to about 76 °C on the surface of the canister in hole 1, to about 102 °C in hole 2, to about 98 °C in hole 3 and to about 93 °C in hole 4.

Sammanfattning

I denna rapport presenteras data från mätningar i Prototypförvaret för perioden 010917-030601. Rapporten är uppdelad så att själva mätresultaten redovisas i Appendix 1-7, varvid Appendix 5 behandlar mätning av kapselförskjutningar (görs av AITEMIN), Appendix 6 behandlar geoelektriska mätningar i återfyllningen (görs av GRS) och Appendix 7 behandlar vattentrycksmätningar i berget (handhas av VBB/VIK). I själva huvudrapporten och Appendix 1-4 behandlas alla övriga mätningar.

Följande mätningar görs i bentoniten i vardera av de två instrumenterade deponeringshålen (1 och 3): Temperatur mäts i 32 punkter, totaltryck i 27 punkter, porvattentryck i 14 punkter och relativa fuktigheten i 37 punkter. Temperaturen mäts även i alla relativa fuktighetsmätare. Varje mätpunkt relateras till ett lokalt koordinatsystem i deponeringshålet.

Följande mätningar görs i återfyllningen: Temperaturen mäts i 20 punkter, totaltryck i 18 punkter, porvattentryck i 23 punkter och relativa fuktigheten i 45 punkter. Temperaturen mäts även i alla relativa fuktighetsmätare. Varje mätpunkt relateras till ett lokalt koordinatsystem i tunneln. Dessutom mäts vatteninnehållet i en sektion med en geoelektrisk mätkedja.

Följande mätningar görs på ytan i kapselns kopparhölje i samtliga 4 kapslar: Temperaturen mäts varje meter längs två fiberoptiska kablar från två håll. Dessutom mäts förskjutningar av kapseln i hål 3 med 6 givare.

Följande mätningar görs i berget: Temperatur mäts i borrhål i 37 punkter i golvet. Vattentryck mäts i sammanlagt 64 punkter i 17 borrhål runt hela tunneln.

En generell slutsats är att mätsystemen och givarna tycks fungera bra. 62 av 253 givare (med undantag av vattentrycksmätare i berget) fungerar inte. Merparten av dessa (33stycken) är RH-mätare som slutar fungera vid vattenmättnad. Ny kalibrering av de fiberoptiska kablarna för temperaturmätning på kapselytorna har gjorts men den är fortfarande preliminär varför nya efterjustering av resultaten kan bli aktuell.

Resultaten bekräftar trenderna från förra rapporten nämligen att en påtaglig bevätning pågår deponeringshål 1, viss bevätning pågår i återfyllningen, men att bevätningen i hål 3 är mycket långsamt. Bevätningen av återfyllningen tycks ha kommit längst ovanför hål 3. Maxtemperaturen hos kapslarna skiljer sig avsevärt åt. Den har stigit till c:a 76 °C på ytan av kapseln i deponeringshål 1 till c:a 102 °C i hål 2, till c:a 98 °C i hål 3 och till c:a 93 °C i hål 4.

Contents

Abstract	3
Sammanfattning	5
Contents	7
1 Introduction	9
2 Results and comments	11
2.1 General	11
2.2 Total pressure in dep. hole 1. Geokon (App. 1\pages 43-45)	12
2.3 Total pressure in dep. hole 3. Geokon (App. 2\pages 71-73)	12
2.4 Total Pressure in dep. hole 1. Kulite (App. 1\page 46)	12
2.5 Total Pressure in dep. hole 3. Kulite (App. 2\pages 74-75)	12
2.6 Relative humidity in dep. hole 1. Vaisala (App. 1\pages 47-50)	12
2.7 Relative humidity in dep. hole 3. Vaisala (App. 2\pages 76-79)	12
2.8 Relative humidity in dep. hole 1. Rotronic (App. 1\pages 51-55)	13
2.9 Relative humidity in dep. hole 3. Rotronic (App. 2\pages 80-84)	13
2.10 Pore water pressure in dep. hole 1. Geokon (App. 1\page 56)	13
2.11 Pore water pressure in dep. hole 3. Geokon (App. 2\page 85)	13
2.12 Pore water pressure in dep. hole 1. Kulite (App. 1\page 57)	13
2.13 Pore water pressure in dep. hole 3. Kulite (App. 2\page 86)	13
2.14 Canister power in dep. hole 1 (App. 1\page 66)	13
2.15 Canister power in dep. hole 3 (App. 2\page 95)	14
2.16 Canister power in dep. hole 2 (App. 3\page 102)	14
2.17 Canister power in dep. hole 4 (App. 3\page 107)	14
2.18 Temperature in the buffer in dep. hole 1 (App. 1\pages 58-62)	14
2.19 Temperature in the buffer in dep. hole 3 (App. 2\pages 87-91 and 94)	14
2.20 Temperature on the canister surface in hole 1. (App. 1\pages 67-68)	14
2.21 Temperature on the canister surface in hole 3. (App. 2\pages 96-97)	15
2.22 Temperature on the canister surface in hole 2. (App. 3\pages 103-105)	15
2.23 Temperature on the canister surface in hole 4. (App. 3\pages 108-109)	15
2.24 Total pressure in the backfill. Geokon (App. 4\pages 113-114)	15
2.25 Total Pressure in the backfill. Kulite (App. 4 \pages 115-116)	15
2.26 Suction in the backfill. Wescor Psychrometers (App. 4\pages 117-123)	15
2.27 Pore water pressure in the backfill. Geokon (App. 4\pages 124-125)	16
2.28 Pore water pressure in the backfill. Kulite (App. 4\pages 126-127)	16
2.29 Temperature in the backfill (App. 4\pages 128-132)	16
2.30 Temperature in the rock near hole 1 (App. 1\pages 63-65)	16
2.31 Temperature in the rock near hole 2 (App. 3\page 101)	16
2.32 Temperature in the rock near hole 3 (App. 2\pages 92-93)	16
2.33 Temperature in the rock near hole 4 (App. 3\page 106)	16

3	Geometry and coordinate systems	17
4	Location of instruments	19
4.1	Brief description of the instruments	19
	Measurements of temperature	19
	Measurement of total pressure in the buffer and backfill	19
	Measurement of pore water pressure in the buffer and backfill	19
	Measurement of the water saturation process in the buffer and backfill	19
4.2	Strategy for describing the position of each device in the bentonite and rock in and around the deposition holes	20
4.3	Position of each instrument in the bentonite in hole 1 (DA3587G01)	23
4.4	Position of each instrument in the bentonite in hole 3 (DA3575G01)	28
4.5	Instruments on the canister surface in holes 1-4	32
4.6	Position of temperature sensors in the rock	34
4.7	Strategy for describing the position of each device in the backfill	35
4.8	Position of each instrument in the backfill	37
	Appendix 1. Deposition hole 1	41
	Appendix 2. Deposition hole 3	69
	Appendix 3. Deposition holes 2 and 4	99
	Appendix 4. Backfill	111
	Appendix 5. Canister displacements	133
	Appendix 6. Geo-electric monitoring	139
	Appendix 7. Water pressure in the rock	171
	Quick guide	227

1 Introduction

The Prototype Repository Test consists of two sections. The installation of the first section of Prototype Repository was made during summer and autumn 2001. Section 2 will be installed in spring 2003.

Section 1 consists of four full-scale deposition holes, copper canisters equipped with electrical heaters, bentonite blocks and a deposition tunnel backfilled with a mixture of bentonite and crushed rock and ends with a concrete plug as shown in Figure 1-1.

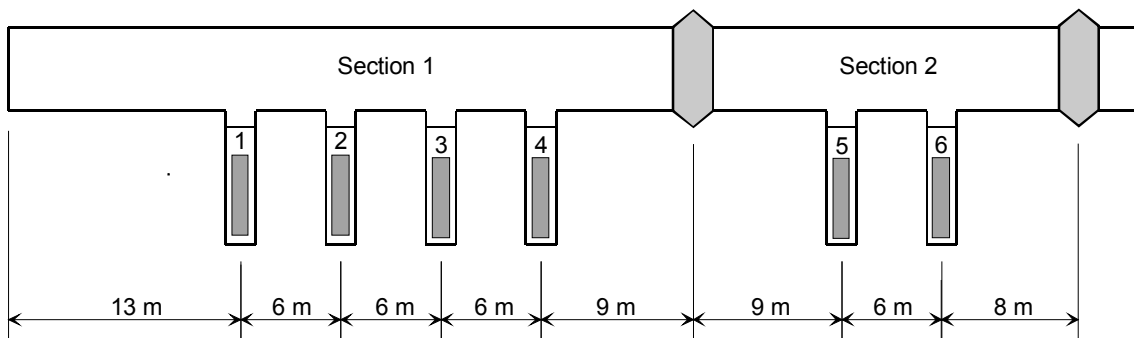

Figure 1-1. Schematic view of the Prototype Repository.

The bentonite buffer in deposition holes 1 and 3, the backfill and the surrounding rock in section 1 are instrumented with gauges for measuring temperature, water pressure, total pressure, relative humidity, resistivity and canister displacement. The instruments are connected to data collection systems by cables protected by tubes, which are led through the rock in watertight lead throughs.

In general the data in this report are presented in diagrams covering the time period 2001-09-17 to 2003-06-01. The time axis in the diagrams represent number of days from start 010917, which is the day the heating of the canister in hole 1 was started.

This report consists of several parts. In chapter 2 the measured results from all measurements, except canister displacement, water pressure in the rock and resistivity, are presented and commented. In chapters 3 and 4 a test overview with the positions of those measuring points and a brief description of the instruments are shown. The diagrams of those measured results are attached in Appendix 1-4. The results and comments of the measurements of canister displacement, water pressure in the rock and resistivity in the backfill are presented separately in Attachments 5, 6 and 7.

A quick guide to the positions of the instruments in the buffer and backfill that can be unfolded to A3 format is enclosed as the last page.

2 Results and comments

2.1 General

In this chapter short comments on general trends in the measurements are given. Sensors that are not delivering reliable data or no data at all are noted and comments on the data collection in general are given.

The heating of the canister in hole1 started with an applied constant power of 1800 W at 010917. This date is also marked as start date. The backfilling started 010903 and was finished 011120 and the plug was cast at 011214. In order to simulate the radioactive decay, the power was decreased 20 W one year after start of the first heater. Table 2-1 shows some important dates for section 1.

Table 2-1. Key dates for section 1

Activity	Date
Start backfilling	3/9 2001
Start heating canister 1	17/9 2001
Start heating canister 2	24/9 2001
Start heating canister 3	11/10 2001
Start heating canister 4	22/10 2001
Finish backfilling	20/11 2001
Plug casting	14/12 2001
Decreased power (-20 W)	17/9 2002

62 out of 253 sensors (excluding water pressure sensors in the rock) are out of order, the majority (33) being RH-sensors that fail at water saturation.

The processes are now very slow. Very small changes have occurred since the previous report.

So far hole 1 has been strongly wetted but very little wetting is observed in hole 3. A slow but obvious wetting of the backfill is noted. The maximum temperature of the canisters differ substantially (C1: 76°C, C2: 102°C, C3: 98°C, C4: 93°C).

2.2 Total pressure in dep. hole1. Geokon (App. 1\pages 43-45)

The measured pressure range is from 0.25 to 8.4 MPa. The highest pressure is indicated from the peripheral transducers in the bottom block (C1). The pressure has not changed very much during the last 3 months, but the pressure increase measured by transducers PBU10011, PBU10021 placed 20-30 cm from the rock has continued.

Four transducers are out of order.

2.3 Total pressure in dep. hole 3. Geokon (App. 2\pages 71-73)

Much lower pressure is registered from hole 3 with maximum pressure 2.1 MPa reached by two transducers. Only four out of 16 shows a pressure higher than 300 kPa. Only small changes of pressure have occurred during this measuring period.

2.4 Total Pressure in dep. hole 1. Kulite (App. 1\page 46)

The highest pressure 6.2 MPa is indicated from the peripheral transducers in Ring 5. Two transducers are out of order since earlier. The other five transducers are temporarily out of order due to data logger problems.

2.5 Total Pressure in dep. hole 3. Kulite (App. 2\pages 74-75)

The highest pressure, 0.6 MPa, is indicated from the peripheral transducers in the Ring 10. The sudden change in pressure that occurs after about 180 days was probably caused by early data logger problems.

One transducer is out of order since earlier. The other five transducers are temporarily out of order due to data logger problems.

2.6 Relative humidity in dep. hole 1. Vaisala (App. 1\pages 47-50)

Since temperature is also measured with all relative humidity sensors, the diagrams include those measured temperatures. The temperature measurements start at about 16 degrees while the RH measurements start at about 70 %RH.

The relative humidity has not changed very much during the last 3 months, but 3 more transducers have failed.

Eleven transducers are out of order most of them due to water saturation.

2.7 Relative humidity in dep. hole 3. Vaisala (App. 2\pages 76-79)

The only increased wetting that can be observed takes place in ring 10 between the canister and the rock. Only small changes are noted.

Three transducers are out of order.

2.8 Relative humidity in dep. hole 1. Rotronic (App. 1\pages 51-55)

All Rotronic transducers placed between the canister and the rock show RH higher than 90%.

Ten transducers are out of order most of them due to water saturation.

2.9 Relative humidity in dep. hole 3. Rotronic (App. 2\pages 80-84)

Many Rotronic transducers in hole 3 have failed or increased the measured RH to 100%. The reason for this is unclear. Since there are no other signs of strong wetting malfunction is more probable than strong wetting. Investigation is going on.

Nine transducers are at present out of order.

2.10 Pore water pressure in dep. hole 1. Geokon (App. 1\page 56)

Very low pore water (or pore gas) pressure is registered so far. The highest pressure 260- 320 kPa is measured in the periphery of ring R5 (UBU10010) and near the canister surface in ring R5 (UBU10009 ,UBU10005).

2.11 Pore water pressure in dep. hole 3. Geokon (App. 2\page 85)

All sensors yield very low pressure except for one sensor below the heater that yields a sudden increase to 220 kPa (questionable).

2.12 Pore water pressure in dep. hole 1. Kulite (App. 1\page 57)

A rather high water pressure is noted from three sensors located in ring R5.

One sensor is out of order.

2.13 Pore water pressure in dep. hole 3. Kulite (App. 2\page 86)

UBU30004 yields a pressure of 350 kPa and this sensor is placed near the rock surface at the bottom of the deposition hole. The other sensors yield very low pressure.

2.14 Canister power in dep. hole 1 (App. 1\page 66)

The power of the canister in hole 1 has been kept constant during one year at 1800 W since the start 010917. After one year the power was decreased with about 20 W.

The interruption in the curve between days 45 and 80 is caused by data collection problems.

2.15 Canister power in dep. hole 3 (App. 2\page 95)

The power of the canister in hole 3 has been kept constant at 1800 W from the start 011011 until 020917, when the power was decreased with about 20 W. Some initial problems have been overcome.

2.16 Canister power in dep. hole 2 (App. 3\page 102)

The power of the canister in hole 3 has been kept constant at 1800 W from the start 010924 until 020917, when the power was decreased with about 20 W. Some initial problems have been overcome.

The interruption in the curve between days 409 and 456 is caused by data collection problems.

2.17 Canister power in dep. hole 4 (App. 3\page 107)

The power of the canister in hole 4 has been kept constant at 1800 W from the start 011022 until 020917, when the power was decreased with about 20 W.

2.18 Temperature in the buffer in dep. hole 1 (App. 1\pages 58-62)

The latest measured temperature ranges from 29 °C (in the periphery of the upper bentonite cylinder C4) to 71.5 °C in the center close to the canister. The highest temperature gradient is 0.65 degrees/cm (ring R5).

2.19 Temperature in the buffer in dep. hole 3 (App. 2\pages 87-91 and 94)

The latest measured temperature ranges from 36.8 °C (in the periphery of the upper bentonite cylinder C4) to a temperature of 80.4 °C in the center close to the canister. The highest temperature gradient is 0.57 degrees/cm (ring R5). There has appeared some problems with some data scan units, which explains the noise in some curves.

TBU30016 placed on top of the canister almost in contact with the canister that failed earlier has been revived.

Five transducers are out of order.

2.20 Temperature on the canister surface in hole 1. (App. 1\pages 67-68)

The first diagram shows the maximum temperature measured in each of the four optical cables placed on the surface of the canister plotted as a function of time. The present maximum measured temperature on the canister surface is about 76 degrees. The second diagram shows the distribution of the temperature along the cables at the end of the period. The length of the cable on the canister surface is only about 20 m. The waves of a few degrees are caused by the difference in temperature in the center and ends of the canister. The change in temperature after 600 days is caused by a recent calibration, which will be updated later on. The curves may thus be further corrected after completed calibration.

2.21 Temperature on the canister surface in hole 3. (App. 2\pages 96-97)

The first diagram shows the maximum temperature plotted as a function of time. The maximum measured temperature on the canister surface is about 98 degrees. The second diagram shows the distribution of the temperature along the cables. See also chapter 2.20.

2.22 Temperature on the canister surface in hole 2. (App. 3\pages 103-105)

See chapter 2.20. The maximum measured temperature on the canister surface is at present between 102 and 106 degrees. The reason for the unexpected increase in temperature after 450 days is not clear.

TBU10006 is placed on the lid of the canister.

2.23 Temperature on the canister surface in hole 4. (App. 3\pages 108-109)

See chapter 2.20. The maximum measured temperature on the canister surface is 93 degrees..

2.24 Total pressure in the backfill. Geokon (App. 4\pages 113-114)

Small and irregular total pressure is measured in the backfill. Only one transducer shows a relevant pressure increase (360 kPa) measured 0.4 m above the bentonite surface in deposition hole 3 (PBA10015).

2.25 Total Pressure in the backfill. Kulite (App.4 \pages 115-116)

Also these measurements yield rather small increase in total pressure. Transducer PBA10013 is placed 1.7 m above the bentonite surface in hole 3 and measures a clearly increasing pressure with the value 280 kPa at the end of the measuring period.

Three transducers are out of order.

2.26 Suction in the backfill. Wescore Psychrometers (App. 4\pages 117-123)

The steady but slow wetting (decrease in suction) observed in about 50% of the sensors continues. 7 sensors close to the roof and walls of the tunnel and one sensor just above the buffer in hole 1 indicate fast wetting that has gone close to water saturation (less than 1000 kPa suction). Also the transducer placed just inside the plug has reached a suction value that indicates saturation

One transducer is out of order due to water saturation.

2.27 Pore water pressure in the backfill. Geokon (App. 4\pages 124-125)

No increase in water pressure is noticed in any of these sensors.

2.28 Pore water pressure in the backfill. Kulite (App. 4\pages 126-127)

All sensors of this type yield very low pressure but a slight increase has started to appear in 3 of them. Two transducers are out of order.

2.29 Temperature in the backfill (App. 4\pages 128-132)

The temperature in the backfill ranges from 17 to 33 degrees. The highest temperature is as expected measured above the buffer in hole 3.

2.30 Temperature in the rock near hole 1 (App. 1\pages 63-65)

The maximum temperature measured in the rock is 37.0 degrees (TROA1030). The sensor is located 2.038 m from the center of the canister in deposition hole 1. Note that this temperature is about 7 degrees lower than in the rock around the other holes.

2.31 Temperature in the rock near hole 2 (App. 3\page 101)

The maximum temperature in the rock (45,5 degrees) is measured by TROA1820 located 2.138 m from the center of the canister in deposition hole 2.

2.32 Temperature in the rock near hole 3 (App. 2\pages 92-93)

The maximum temperature in the rock (47,0 degrees) is measured by TROA2120 located 1.967 m from the center of the canister in deposition hole 3.

2.33 Temperature in the rock near hole 4 (App. 3\page 106)

The maximum temperature in the rock (44,5 degrees) is measured by TROA3030 located 2.038 m from the center of the canister in deposition hole 4.

3 Geometry and coordinate systems

The Prototype Repository consists of two sections as shown in Figure 1-1. The geometry and the coordinate system for the sensors are different for the deposition holes and the tunnel. The temperature sensors in the rock are defined with the same coordinate system as the deposition holes.

Deposition holes

In section 1 the deposition holes are termed 1-4 according to Figure 1-1. The coordinate system for these holes is shown in Figure 3-1. With the z -axis starting from the cement casting and the angle α counted anti-clockwise for direction A. Measurements are mainly made in four vertical sections A, B, C and D according to Figure 3-1. Direction A and C are placed in the tunnels axial direction with A headed against the end of the tunnel i.e. almost towards West.

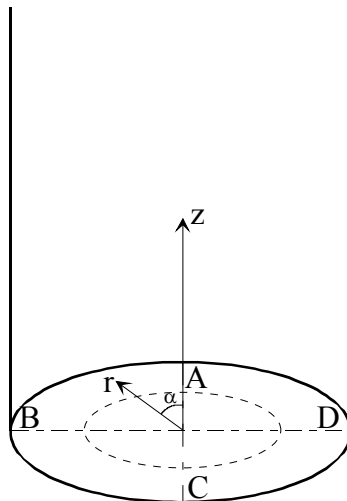

Figure 3-1. Figure describing the instrument planes (A-C) and the coordinate system used when describing the instrument positions.

Tunnel

The coordinate system of the backfill in the tunnel is shown in Figure 3-2. The coordinate y starts at the entrance on ground, which means that the backfill of section 1 starts at $y= 3561.4$ and ends at 3599.8 , corresponding to the inner the surface of the inner plug. The y -axis runs in the center of the tunnel, which means that the tunnel walls intersect the y and x -axes at ± 2.5 m.

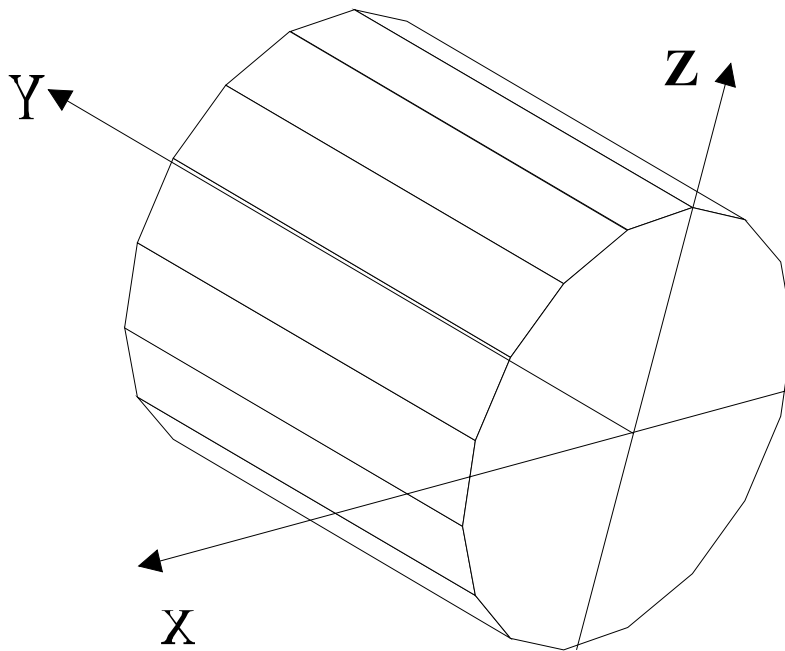

Figure 3-2. Coordinate system of the tunnel

4 Location of instruments

4.1 Brief description of the instruments

The different instruments that are used in the buffer, backfill and rock (temperature) are briefly described in this chapter.

Measurements of temperature

Buffer, backfill and rock

Thermocouples from Pentronic have been used to measure temperature. Measurements are done in 32 points in each instrumented hole (hole 1 and hole 3). In addition, temperature gauges are built into the capacitive relative humidity sensors and some of the other sensor types as well.

Canister

Temperature is measured on the surface of the canister with optical fiber cables. An optical measuring system called FTR (Fiber Temperature Laser Radar) is used.

Measurement of total pressure in the buffer and backfill

Total pressure is the sum of the swelling pressure and the pore water pressure. It is measured with the following instrument types:

- Geocon total pressure cells with vibrating wire transducers.
- Kulite total pressure cells with piezo resistive transducers.

Measurement of pore water pressure in the buffer and backfill

Pore water pressure is measured with the following instrument types:

- Geocon pore pressure cells with vibrating wire transducer.
- Kulite pore pressure cells with piezo resistive transducer.

Measurement of the water saturation process in the buffer and backfill

The water saturation process is recorded by measuring the relative humidity in the pore system, which can be converted to total suction (negative water pressure). The following techniques and devices are used:

- Vaisala relative humidity sensor of capacitive type. The measuring range is 0-100 % RH.
- Rotronic relative humidity sensors of capacitive type. The measuring range is 0-100 % RH.
- Wescor soil psychrometer. The sensor is measuring the dry and the wet temperature in the pore volume of the material. The measuring range is 95.5-99.6 % RH corresponding to the pore water pressure -0.5 to -6 MPa.. Psychrometers are only placed in the backfill.

4.2 Strategy for describing the position of each device in the bentonite and rock in and around the deposition holes

The same principles are used for describing the position of all sensors in the bentonite inside the deposition holes as well as the thermocouples in the rock around the deposition holes. The principles are described in the quick guide inserted as a folded A3 page at the end of the report.

Every instrument is named with a unique name consisting of 1 letter describing the type of measurement, 2 letters describing where the measurement takes place (buffer, backfill, rock or canister), 1 figure denoting the deposition hole (1-4) and 4 figures specifying the instrument according to a separate list (see Table 4-1 to 4-10). Every instrument position is then described with three coordinates according to Figure 3-1.

The r -coordinate is the horizontal distance from the center of the hole and the z -coordinate is the height from the surface of the bottom casting of the hole (the block height is set to 500mm). The α -coordinate is the angle from the vertical direction A (almost West).

Figure 4-1 shows an overview of the instruments in the buffer. The bentonite blocks are called cylinders and rings. The cylinders are numbered C1-C4 and the rings R1-R10 respectively.

- pore water pressure + temp.
- total pressure + temp.
- × temp.
- △ relative humidity (+ temp.)

1m

A B+C D

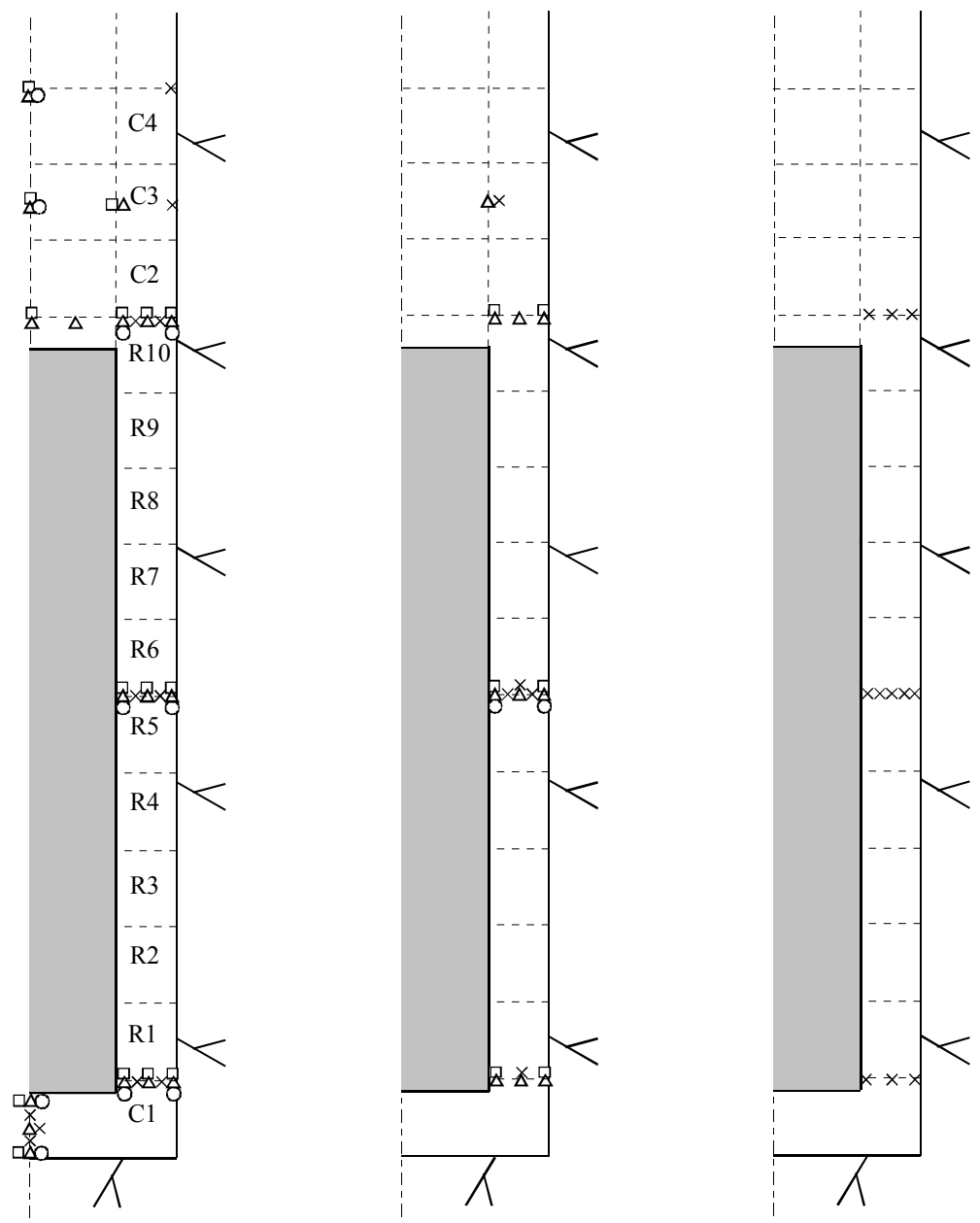

Figure 4-1 Schematic view over the instruments in four vertical sections and the block designation.

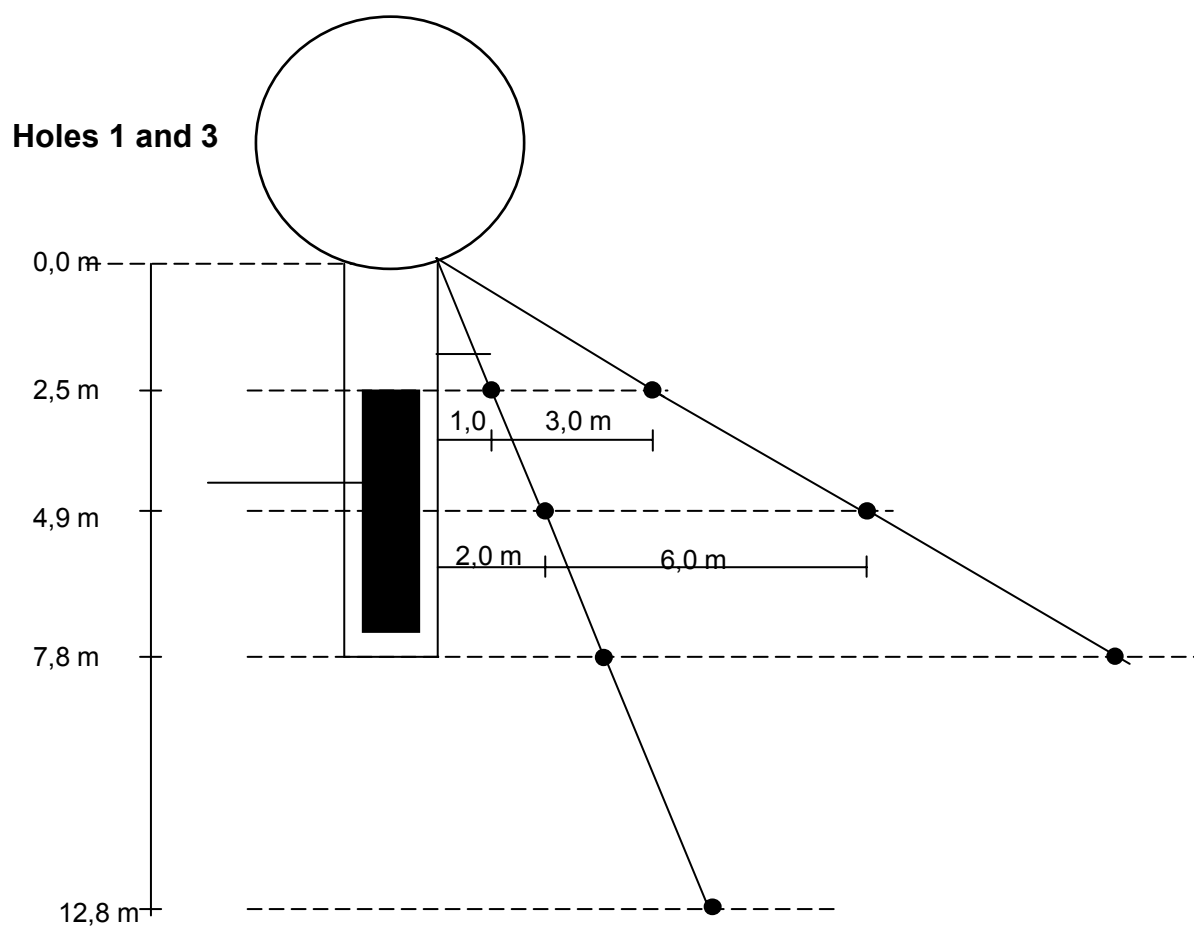
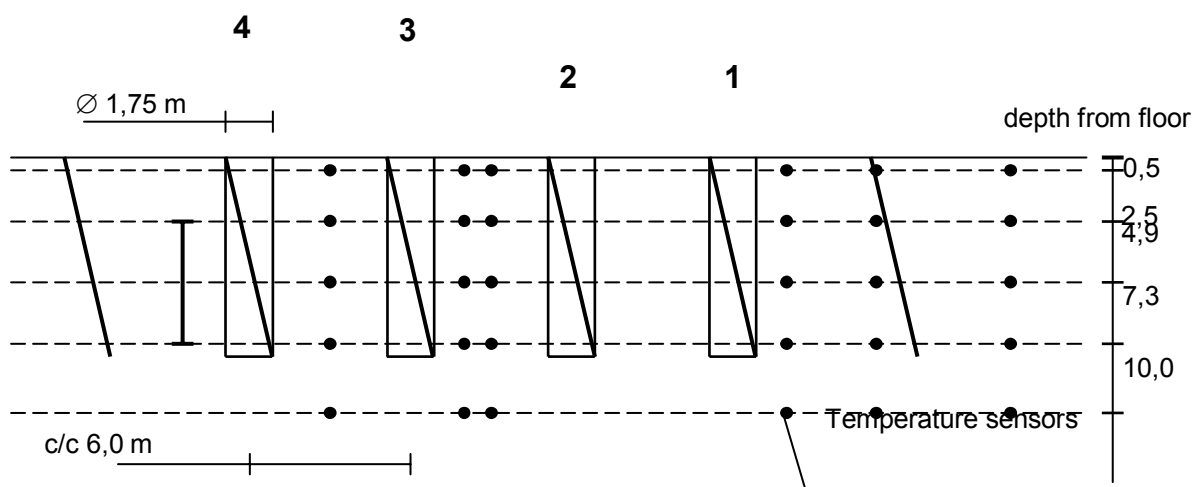

Figure 4-2. Overview of the temperature sensors in the rock. Length section (upper) and cross section

4.3 Position of each instrument in the bentonite in hole 1 (DA3587G01)

The instruments are located in three main levels in the blocks, 50 mm, 160 mm and 250 mm, from the upper surface. The thermocouples are mostly placed in the 50mm level and the other gauges in the 160 mm level except for the Geokon type 1 pressure sensors and the Rotronic humidity sensors, which are placed in the 250 mm level depending on the size of the sensor house.

Exact positions of the sensors are described in Tables 4-1 to 4-4.

Table 4-1 Numbering and position of instruments for measuring temperature (T) in the buffer in hole 1

Type and number	Block	Instrument position				Fabricate	Remark
		Direction	α degree	r m	Z m		
TBU10001	Cyl. 1	Center	270	0,050	0,054	Pentronic	
TBU10002	Cyl. 1	Center	270	0,050	0,254	Pentronic	
TBU10003	Cyl. 1	Center	270	0,050	0,454	Pentronic	
TBU10004	Cyl. 1	A	355	0,635	0,454	Pentronic	
TBU10005	Cyl. 1	A	355	0,735	0,454	Pentronic	
TBU10006	On top of the canister in hole 2					Pentronic	
TBU10007	Cyl. 1	C	175	0,685	0,454	Pentronic	
TBU10008	Cyl. 1	D	270	0,585	0,454	Pentronic	
TBU10009	Cyl. 1	D	270	0,685	0,454	Pentronic	
TBU10010	Cyl. 1	D	270	0,785	0,454	Pentronic	
TBU10011	Ring 5	A	0	0,635	2,980	Pentronic	
TBU10012	Ring 5	A	0	0,735	2,980	Pentronic	
TBU10013	Ring 5	B	90	0,585	2,980	Pentronic	
TBU10014	Ring 5	B	90	0,685	2,980	Pentronic	
TBU10015	Ring 5	B	90	0,785	2,980	Pentronic	
TBU10016	Ring 5	C	175	0,585	2,980	Pentronic	
TBU10017	Ring 5	C	175	0,685	2,980	Pentronic	
TBU10018	Ring 5	C	175	0,735	2,980	Pentronic	
TBU10019	Ring 5	D	270	0,585	2,980	Pentronic	
TBU10020	Ring 5	D	270	0,635	2,980	Pentronic	
TBU10021	Ring 5	D	270	0,685	2,980	Pentronic	
TBU10022	Ring 5	D	270	0,735	2,980	Pentronic	
TBU10023	Ring 5	D	270	0,785	2,980	Pentronic	
TBU10024	Ring 10	A	0	0,635	5,508	Pentronic	
TBU10025	Ring 10	A	0	0,735	5,508	Pentronic	
TBU10026	Ring 10	D	270	0,585	5,508	Pentronic	
TBU10027	Ring 10	D	270	0,685	5,508	Pentronic	
TBU10028	Ring 10	D	270	0,785	5,508	Pentronic	
TBU10029	Cyl. 3	A	0	0,785	6,317	Pentronic	
TBU10030	Cyl. 3	B	95	0,585	6,317	Pentronic	
TBU10031	Cyl. 3	C	185	0,585	6,317	Pentronic	
TBU10032	Cyl. 4	A	0	0,785	7,026	Pentronic	

Table 4-2 Numbering and position of instruments for measuring total pressure (P) in the buffer in hole 1

Type and number	Block	Instrument position				Fabricate	Remark
		Direction	α degree	r m	Z m		
PBU10001	Cyl. 1	Center	0	0,000	0,000	Geocon	In cement
PBU10002	Cyl. 1	Center	0	0,100	0,504	Geocon	
PBU10003	Cyl. 1	A	5	0,585	0,504	Kulite	Vertical
PBU10004	Cyl. 1	A	5	0,685	0,504	Kulite	Vertical
PBU10005	Cyl. 1	A	5	0,785	0,504	Kulite	Vertical
PBU10006	Cyl. 1	B	95	0,635	0,504	Geocon	
PBU10007	Cyl. 1	B	105	0,735	0,504	Geocon	
PBU10008	Cyl. 1	C	185	0,635	0,504	Geocon	
PBU10009	Cyl. 1	C	195	0,735	0,504	Geocon	
PBU10011	Ring 5	A	5	0,685	2,780	Geocon I	
PBU10012	Ring 5	A	5	0,785	3,030	Kulite	In the slot
PBU10013	Ring 5	B	95	0,585	2,780	Geocon I	
PBU10014	Ring 5	B	95	0,785	2,780	Geocon I	
PBU10015	Ring 5	C	185	0,535	3,030	Geocon I	In the slot
PBU10016	Ring 5	C	185	0,825	2,870	Kulite	In the slot
PBU10017	Ring 10	Center	0	0,050	5,558	Geocon	
PBU10019	Ring 10	A	5	0,685	5,558	Kulite	Vertical
PBU10020	Ring 10	A	5	0,785	5,558	Kulite	Vertical
PBU10021	Ring 10	B	90	0,635	5,558	Geocon	
PBU10022	Ring 10	B	100	0,735	5,558	Geocon	
PBU10023	Ring 10	C	190	0,735	5,558	Geocon	
PBU10024	Ring 10	C	180	0,635	5,558	Geocon	
PBU10025	Cyl. 3	Center	0	0,050	6,317	Kulite	Vertical
PBU10026	Cyl. 3	A	5	0,585	6,567	Geocon	
PBU10027	Cyl. 4	Center	0	0,050	7,076	Kulite	Vertical

Table 4-3 Numbering and position of instruments for measuring pore water pressure (U) in the buffer in hole 1

Type and number	Block	Instrument position				Fabricate	Remark
		Direction	α degree	r m	Z m		
UBU10001	Cyl. 1	Center	90	0,050	0,054	Kulite	
UBU10002	Cyl. 1	Center	90	0,050	0,254	Geocon	Horizontal
UBU10003	Cyl. 1	A	355	0,585	0,344	Geocon	
UBU10004	Cyl. 1	A	355	0,785	0,344	Kulite	
UBU10005	Ring 5	A	355	0,585	2,780	Geocon	
UBU10006	Ring 5	A	355	0,785	2,870	Kulite	
UBU10007	Ring 5	B	85	0,535	2,870	Kulite	In the slot
UBU10008	Ring 5	B	85	0,825	2,870	Kulite	In the slot
UBU10009	Ring 5	C	175	0,535	2,780	Geocon	In the slot
UBU10010	Ring 5	C	175	0,825	2,780	Geocon	In the slot
UBU10011	Ring 10	A	355	0,585	5,398	Kulite	
UBU10012	Ring 10	A	355	0,785	5,308	Geocon	
UBU10013	Cyl. 3	Center	90	0,050	6,317	Geocon	
UBU10014	Cyl. 4	Center	90	0,050	6,916	Geocon	

Table 4-4 Numbering and position of instruments for measuring water content (W) in the buffer in hole 1

Type and number	Block	Instrument position				Fabricate	Remark
		Direction	α degree	r m	Z m		
WBU10001	Cyl. 1	Center	180	0,050	0,054	Rotronic	
WBU10002	Cyl. 1	Center	0	0,400	0,254	Rotronic	
WBU10003	Cyl. 1	Center	180	0,100	0,254	Rotronic	Horizontal
WBU10004	Cyl. 1	A	350	0,785	0,344	Vaisala	
WBU10005	Cyl. 1	A	350	0,685	0,344	Vaisala	
WBU10006	Cyl. 1	A	350	0,585	0,344	Vaisala	
WBU10007	Cyl. 1	B	80	0,585	0,344	Vaisala	
WBU10008	Cyl. 1	B	80	0,685	0,254	Rotronic	
WBU10009	Cyl. 1	B	80	0,785	0,254	Rotronic	
WBU10010	Cyl. 1	C	170	0,585	0,254	Rotronic	
WBU10011	Cyl. 1	C	170	0,685	0,254	Rotronic	
WBU10012	Cyl. 1	C	170	0,785	0,254	Rotronic	
WBU10013	Ring 5	A	350	0,585	2,870	Vaisala	
WBU10014	Ring 5	A	350	0,685	2,870	Vaisala	
WBU10015	Ring 5	A	350	0,785	2,870	Vaisala	
WBU10016	Ring 5	B	80	0,535	2,780	Rotronic	In the slot
WBU10017	Ring 5	B	80	0,685	2,780	Rotronic	
WBU10018	Ring 5	B	80	0,785	2,780	Rotronic	
WBU10019	Ring 5	C	180	0,535	2,870	Vaisala	In the slot
WBU10020	Ring 5	C	180	0,685	2,870	Vaisala	
WBU10021	Ring 5	C	180	0,785	2,780	Rotronic	
WBU10022	Ring 10	Center	0	0,050	5,418	Vaisala	
WBU10023	Ring 10	A	180	0,362	5,428	Vaisala	
WBU10024	Ring 10	A	350	0,585	5,398	Vaisala	
WBU10025	Ring 10	A	350	0,685	5,398	Vaisala	
WBU10026	Ring 10	A	350	0,785	5,398	Vaisala	
WBU10027	Ring 10	B	80	0,585	5,308	Rotronic	
WBU10028	Ring 10	B	80	0,685	5,308	Rotronic	
WBU10029	Ring 10	B	80	0,785	5,308	Rotronic	
WBU10030	Ring 10	C	170	0,585	5,398	Vaisala	
WBU10031	Ring 10	C	170	0,785	5,308	Rotronic	
WBU10032	Cyl. 3	Center	270	0,050	6,317	Vaisala	
WBU10033	Cyl. 3	A	350	0,585	6,317	Vaisala	
WBU10034	Cyl. 3	B	90	0,585	6,317	Vaisala	
WBU10035	Cyl. 3	C	180	0,585	6,317	Rotronic	
WBU10036	Cyl. 4	Center	180	0,050	6,916	Vaisala	
WBU10037	Cyl. 4	Center	270	0,050	6,756	Vaisala	

4.4 Position of each instrument in the bentonite in hole 3 (DA3575G01)

The instruments are located according to the same system as those in hole 1.

The positions of each instrument are described in Tables 4-6 to 4-10.

Table 4-6 Numbering and position of instruments for measuring temperature (T) in the buffer in hole 3

Type and number	Block	Instrument position				Fabricate	Remark
		Direction	α degree	r m	Z m		
TBU30001	Cyl. 1	Center	270	0,050	0,095	Pentronic	
TBU30002	Cyl. 1	Center	270	0,050	0,295	Pentronic	
TBU30003	Cyl. 1	Center	270	0,050	0,445	Pentronic	
TBU30004	Cyl. 1	A	355	0,635	0,445	Pentronic	
TBU30005	Cyl. 1	A	355	0,735	0,445	Pentronic	
TBU30006	Cyl. 1	B	85	0,685	0,445	Pentronic	
TBU30007	Cyl. 1	C	175	0,685	0,445	Pentronic	
TBU30008	Cyl. 1	D	270	0,585	0,445	Pentronic	
TBU30009	Cyl. 1	D	270	0,685	0,445	Pentronic	
TBU30010	Cyl. 1	D	270	0,785	0,445	Pentronic	
TBU30011	Ring 5	A	0	0,635	2,971	Pentronic	
TBU30012	Ring 5	A	0	0,735	2,971	Pentronic	
TBU30013	Ring 5	B	90	0,585	2,971	Pentronic	
TBU30014	Ring 5	B	90	0,685	2,971	Pentronic	
TBU30015	Ring 5	B	90	0,785	2,971	Pentronic	
TBU30016	Ring 10	A	329	0,410	5,394	Pentronic	Just above canister lid
TBU30017	Ring 5	C	175	0,685	2,971	Pentronic	
TBU30018	Ring 5	C	175	0,735	2,971	Pentronic	
TBU30019	Ring 5	D	270	0,585	2,971	Pentronic	
TBU30020	Ring 5	D	270	0,635	2,971	Pentronic	
TBU30021	Ring 5	D	270	0,685	2,971	Pentronic	
TBU30022	Ring 5	D	270	0,735	2,971	Pentronic	
TBU30023	Ring 5	D	270	0,785	2,971	Pentronic	
TBU30024	Ring 10	A	0	0,635	5,504	Pentronic	
TBU30025	Ring 10	A	0	0,735	5,504	Pentronic	
TBU30026	Ring 10	D	270	0,585	5,504	Pentronic	
TBU30027	Ring 10	D	270	0,685	5,504	Pentronic	
TBU30028	Ring 10	D	270	0,785	5,504	Pentronic	
TBU30029	Cyl. 3	A	0	0,785	6,314	Pentronic	
TBU30030	Cyl. 3	B	95	0,585	6,314	Pentronic	
TBU30031	Cyl. 3	C	185	0,585	6,314	Pentronic	
TBU30032	Cyl. 4	A	0	0,785	7,015	Pentronic	

Table 4-7 Numbering and position of instruments for measuring total pressure (P) in the buffer in hole 3

Type and number	Block	Instrument position				Fabricate	Remark
		Direction	α degree	r m	Z m		
PBU30001	Cyl. 1	Center	0	0,000	0,000	Geocon	In cement
PBU30002	Cyl. 1	Center	0	0,100	0,495	Geocon	
PBU30003	Cyl. 1	A	5	0,585	0,495	Kulite	Vertical
PBU30004	Cyl. 1	A	5	0,685	0,495	Kulite	Vertical
PBU30005	Cyl. 1	A	5	0,785	0,495	Kulite	Vertical
PBU30006	Cyl. 1	B	95	0,635	0,495	Geocon	
PBU30007	Cyl. 1	B	105	0,735	0,495	Geocon	
PBU30008	Cyl. 1	C	185	0,635	0,495	Geocon	
PBU30009	Cyl. 1	C	195	0,735	0,495	Geocon	
PBU30010	Ring 5	A	5	0,535	3,021	Kulite	In the slot
PBU30011	Ring 5	A	5	0,685	2,771	Geocon I	
PBU30012	Ring 5	A	5	0,825	3,021	Kulite	In the slot
PBU30013	Ring 5	B	95	0,585	2,771	Geocon I	
PBU30014	Ring 5	B	95	0,785	2,771	Geocon I	
PBU30015	Ring 5	C	185	0,535	3,021	Geocon I	In the slot
PBU30016	Ring 5	C	185	0,825	2,971	Kulite	In the slot
PBU30017	Ring 10	Center	0	0,050	5,556	Geocon	
PBU30018	Ring 10	A	5	0,585	5,556	Kulite	Vertical
PBU30019	Ring 10	A	5	0,685	5,556	Kulite	Vertical
PBU30020	Ring 10	A	5	0,785	5,556	Kulite	Vertical
PBU30021	Ring 10	B	90	0,635	5,556	Geocon	
PBU30022	Ring 10	B	100	0,735	5,556	Geocon	
PBU30023	Ring 10	C	180	0,735	5,556	Geocon	
PBU30024	Ring 10	C	190	0,635	5,556	Geocon	
PBU30025	Cyl. 3	Center	0	0,050	6,314	Kulite	Vertical
PBU30026	Cyl. 3	A	5	0,585	6,564	Geocon	
PBU30027	Cyl. 4	Center	0	0,050	7,065	Kulite	Vertical

Table 4-8 Numbering and position of instruments for measuring pore water pressure (U) in the buffer in hole 3

Type and number	Block	Instrument position				Fabricate	Remark
		Direction	α degree	r m	Z m		
UBU30001	Cyl. 1	Center	90	0,050	0,045	Kulite	
UBU30002	Cyl. 1	Center	90	0,100	0,245	Geocon	Horizontal
UBU30003	Cyl. 1	A	355	0,585	0,335	Geocon	
UBU30004	Cyl. 1	A	355	0,785	0,335	Kulite	
UBU30005	Ring 5	A	355	0,585	2,771	Geocon	
UBU30006	Ring 5	A	355	0,785	2,861	Kulite	
UBU30007	Ring 5	B	85	0,535	2,861	Kulite	In the slot
UBU30008	Ring 5	B	85	0,825	2,861	Kulite	In the slot
UBU30009	Ring 5	C	175	0,535	2,771	Geocon	In the slot
UBU30010	Ring 5	C	175	0,825	2,771	Geocon	In the slot
UBU30011	Ring 10	A	355	0,585	5,396	Kulite	
UBU30012	Ring 10	A	355	0,785	5,306	Geocon	
UBU30013	Cyl. 3	Center	90	0,050	6,314	Geocon	
UBU30014	Cyl. 4	Center	90	0,050	6,910	Geocon	

Table 4-9 Numbering and position of instruments for measuring water content (W) in the buffer in hole 3

Type and number	Block	Instrument position			Fabricate	Remark
		Direction	α degree	r m		
WBU30001	Cyl. 1	Center	180	0,050	0,045	Rotronic
WBU30002	Cyl. 1	Center	0	0,400	0,215	Rotronic
WBU30003	Cyl. 1	Center	180	0,100	0,245	Rotronic
WBU30004	Cyl. 1	A	350	0,785	0,335	Vaisala
WBU30005	Cyl. 1	A	350	0,685	0,335	Vaisala
WBU30006	Cyl. 1	A	350	0,585	0,335	Vaisala
WBU30007	Cyl. 1	B	80	0,585	0,335	Vaisala
WBU30008	Cyl. 1	B	80	0,685	0,245	Rotronic
WBU30009	Cyl. 1	B	80	0,785	0,245	Rotronic
WBU30010	Cyl. 1	C	170	0,585	0,245	Rotronic
WBU30011	Cyl. 1	C	170	0,685	0,245	Rotronic
WBU30012	Cyl. 1	C	170	0,785	0,245	Rotronic
WBU30013	Ring 5	A	350	0,585	2,861	Vaisala
WBU30014	Ring 5	A	350	0,685	2,861	Vaisala
WBU30015	Ring 5	A	350	0,785	2,861	Vaisala
WBU30016	Ring 5	B	80	0,535	2,771	Rotronic
WBU30017	Ring 5	B	80	0,685	2,771	Rotronic
WBU30018	Ring 5	B	80	0,785	2,771	Rotronic
WBU30019	Ring 5	C	180	0,535	2,861	Vaisala
WBU30020	Ring 5	C	180	0,685	2,861	Vaisala
WBU30021	Ring 5	C	180	0,785	2,771	Rotronic
WBU30022	Ring 10	Center	180	0,050	5,416	Vaisala
WBU30023	Ring 10	A	352	0,262	5,396	Vaisala
WBU30024	Ring 10	A	350	0,585	5,396	Vaisala
WBU30025	Ring 10	A	350	0,785	5,396	Vaisala
WBU30026	Ring 10	A	350	0,685	5,396	Vaisala
WBU30027	Ring 10	B	80	0,585	5,306	Rotronic
WBU30028	Ring 10	B	80	0,685	5,306	Rotronic
WBU30029	Ring 10	B	80	0,785	5,306	Rotronic
WBU30030	Ring 10	C	170	0,585	5,396	Vaisala
WBU30031	Ring 10	C	170	0,785	5,306	Rotronic
WBU30032	Cyl. 3	Center	180	0,050	6,314	Vaisala
WBU30033	Cyl. 3	A	350	0,585	6,314	Vaisala
WBU30034	Cyl. 3	B	90	0,585	6,314	Vaisala
WBU30035	Cyl. 3	C	180	0,585	6,314	Rotronic
WBU30036	Cyl. 4	Center	180	0,050	6,910	Vaisala
WBU30037	Cyl. 4	Center	270	0,050	6,750	Vaisala

4.5 Instruments on the canister surface in holes 1-4

The canisters are instrumented with optical fiber cables on the copper surface. Figure 4-3 shows how two optical fiber cables are placed on the canister surface. Both ends of a cable are used for measurements. This means that the two cables are used for four measurements.

With this laying the cables will enter and exit the surface at almost the same position. Curvatures are shaped as a quarter circle with a radius of 20 cm. The cables are placed in a milled out channels on the surface. The channels have a width and a depth of just above 2 mm

In addition to the optical cables one thermocouple (TBU 10006) is fixed to the lid of the canister in deposition hole 2 (see Table 2-1).

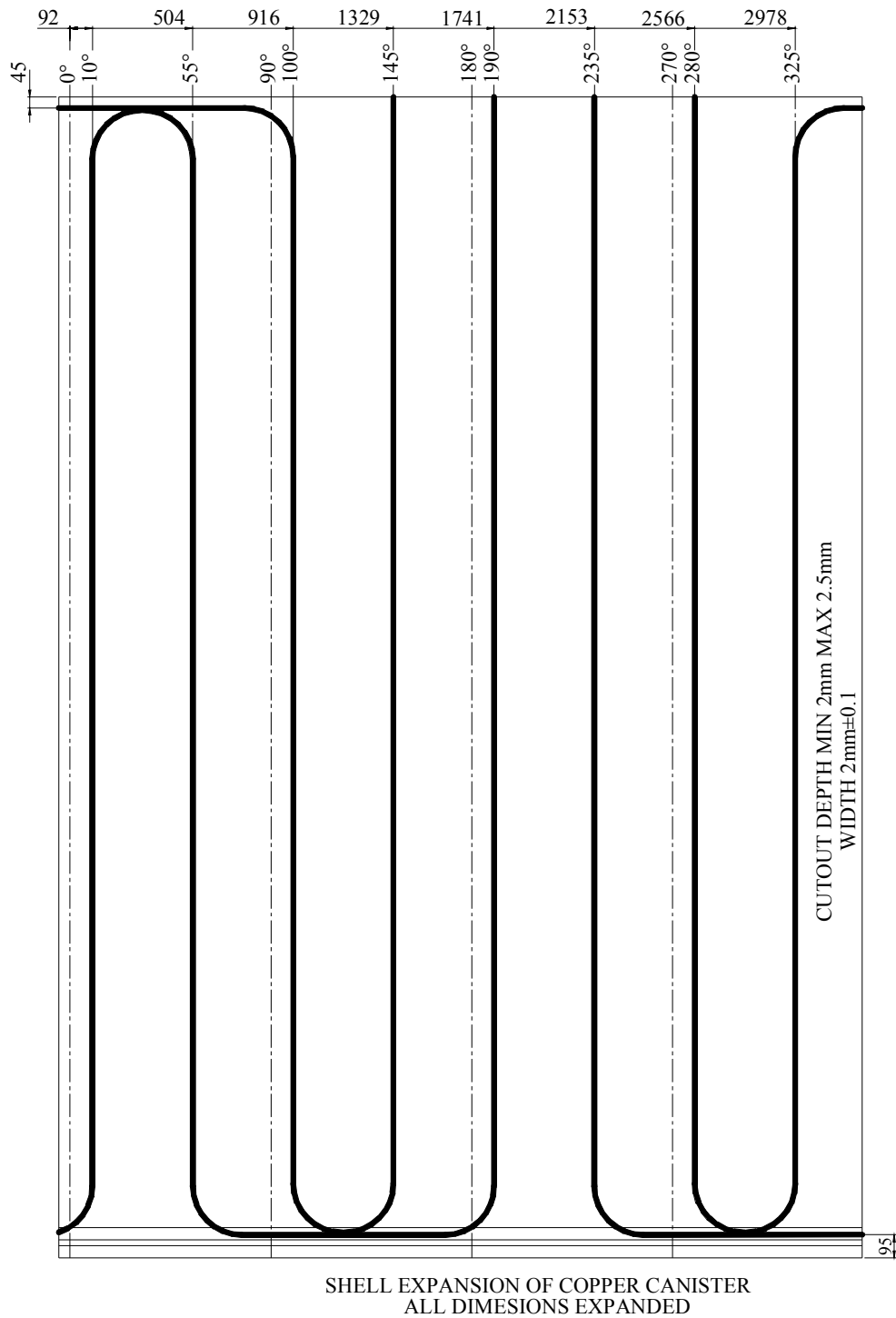

Figure 4-3. Laying of the optical fiber cables with protection tube of Inconel 625 (outer diameter 2 mm) for measurement of the canister surface temperature (surface unfolded)

4.6 Position of temperature sensors in the rock

The positions of the temperature sensors in the rock are termed in the same way as the sensors in the buffer in the deposition holes. The sensors are assigned to the closest deposition hole. The positions are described in Table 4-10.

Table 4-10. Numbering and position of temperature sensors in the rock

Instrument position in rock				
Type and number	α degree	r m	Z m	Fabricate
Measured from DA3587G01 (Hole 1)				
TROA0350	360°	9,086	7,784	
TROA0340	360°	9,086	5,784	
TROA0330	0°	9,086	3,384	
TROA0320	0°	9,087	0,985	
TROA0310	0°	9,086	-1,715	
TROA0650	360°	4,996	7,921	
TROA0640	360°	4,988	5,921	
TROA0630	360°	4,978	3,521	
TROA0620	360°	4,968	1,121	
TROA0610	360°	4,956	-1,479	
TROA1050	359°	2,02	7,662	
TROA1040	359°	2,028	5,662	
TROA1030	359°	2,038	3,262	
TROA1020	359°	2,048	0,862	
TROA1010	359°	2,059	-1,838	
Measured from DA3581G01(Hole 2)				
TROA1840	180°	2,404	7,5868	
TROA1830	180°	2,427	6,0868	
TROA1820	179°	2,49	2,1378	
TROA1810	179°	2,542	-1,1622	
Measured from DA3575G01(Hole 3)				
TROA2150	134°	3,284	7,958	
TROA2140	1°	1,999	5,979	
TROA2130	2°	1,981	4,23	
TROA2120	2°	1,967	2,84	
TROA2110	3°	1,95	1,17	
TROA1850	0°	2,019	7,889	
TROA2330	90°	2,169	7,924	
TROA2320	90°	1,787	6,632	
TROA2310	109°	7,111	4,64	
TROA2440	124°	4,088	7,174	
TROA2430	90°	2,737	4,319	
TROA2420	89°	3,914	1,451	
TROA2410	89°	5,861	-3,295	
Measured from DA3569G01 (Hole 4)				
TROA3050	360°	2,017	7,671	
TROA3040	359°	2,025	5,671	
TROA3030	358°	2,034	3,271	
TROA3020	358°	2,045	0,871	
TROA3010	357°	2,056	-1,778	

4.7 Strategy for describing the position of each device in the backfill

The principles of terming the instruments are described in the quick guide inserted as a folded A3 page at the end of the report.

Every instrument is named with a unique name consisting of 1 letter describing the type of measurement, 2 letters describing where the measurement takes place (buffer, backfill, rock or canister) and 5 figures specifying the instrument according to separate lists (see Tables 4-11 to 4-14). Every instrument position is then described with three coordinates according to Figure 3-2. The x -coordinate is the horizontal distance from the center of the tunnel and the z -coordinate is the vertical distance from the center of the tunnel. The y -coordinate is the same as in the tunnel coordinate system, i.e. $y=3599$ corresponds to the end of the tunnel.

The backfill is mainly instrumented in vertical sections straight above and between the deposition holes (Figures 4-4 and 4-5).

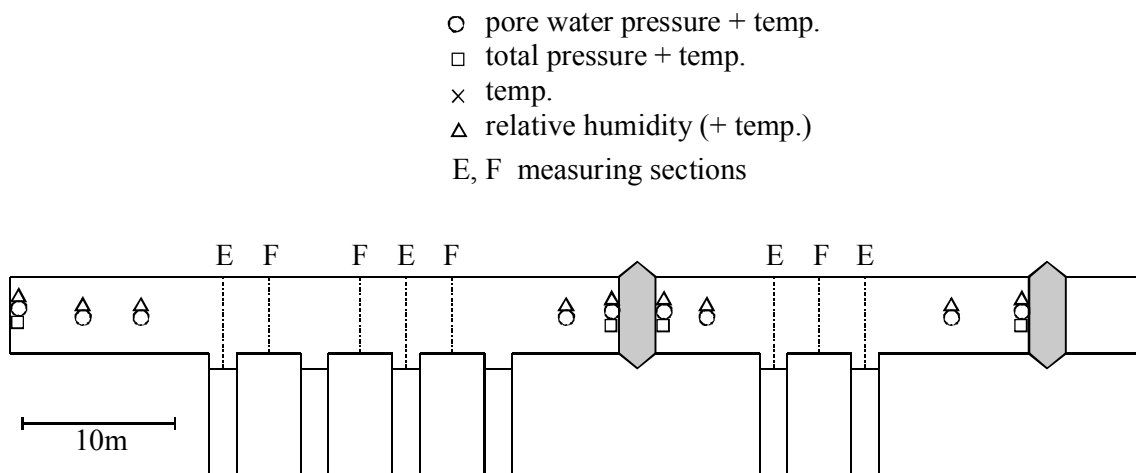

Figure 4-4 Schematic view over the instrumentation of the backfill

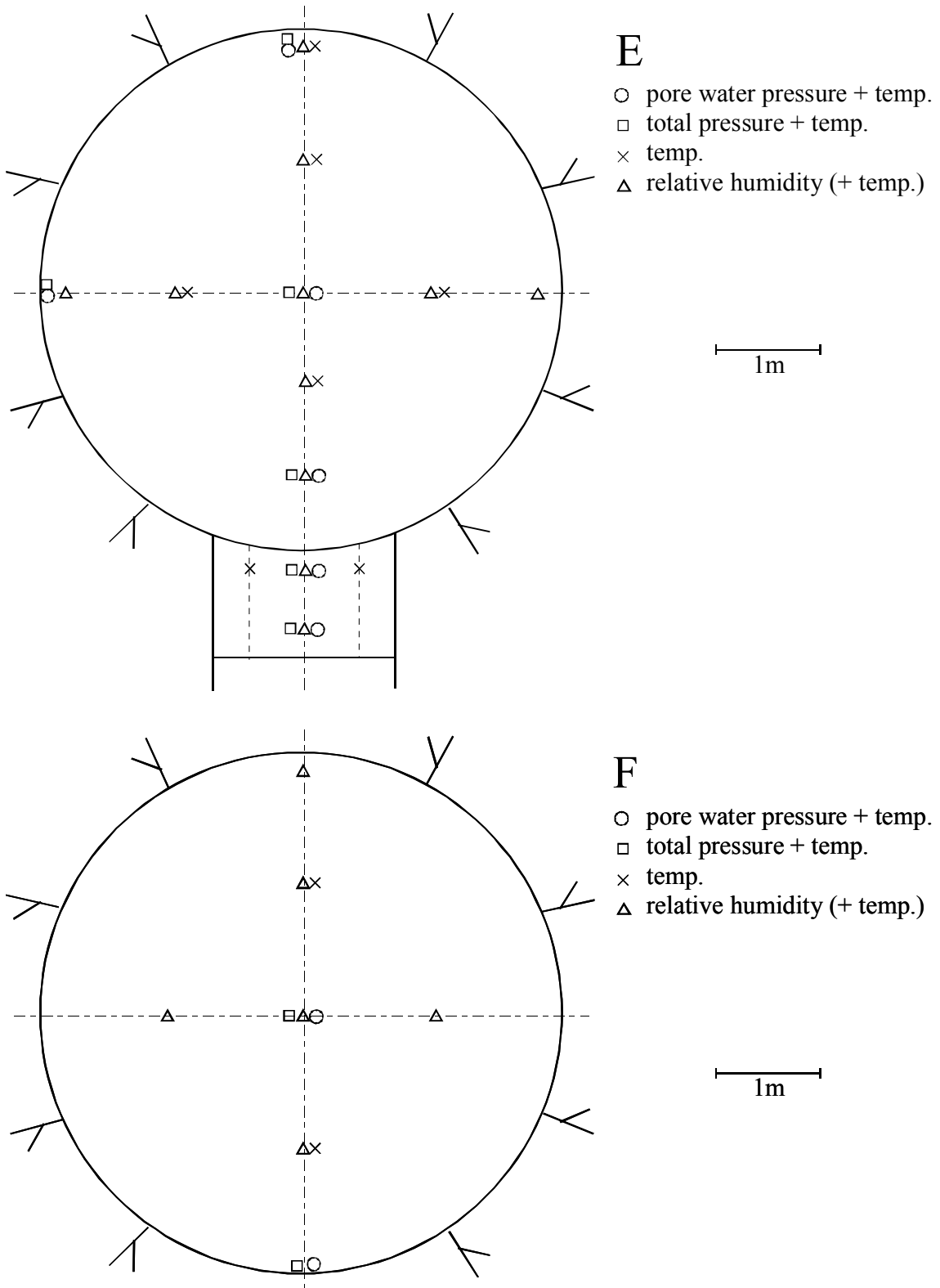

Figure 4-5 Schematic view over the sensors positions in the different sections.

4.8 Position of each instrument in the backfill

The positions of each instrument are described in Tables 4-11 to 6-14.

Table 4-11 Numbering and position of instruments for measuring temperature (T) in the backfill

Type and number	Instrument position			Fabricate	Remark
	Section	x	z		
		m	m	m	
TBA10001	E, over dep.hole 1	-1,3	-0,1	3 587	Pentronic
TBA10002	E, over dep.hole 1	0,1	1,3	3 587	Pentronic
TBA10003	E, over dep.hole 1	0,0	-0,8	3 587	Pentronic
TBA10004	E, over dep.hole 1	-0,5	-2,6	3 587	Pentronic
TBA10005	E, over dep.hole 1	0,5	-2,6	3 587	Pentronic
TBA10006	E, over dep.hole 1	-0,1	2,3	3 587	Pentronic
TBA10007	E, over dep.hole 1	1,3	-0,1	3 587	Pentronic
TBA10008	F, between dep.hole 1 and 2	0,0	1,3	3 584	Pentronic
TBA10009	F, between dep.hole 1 and 2	-0,1	-1,3	3 584	Pentronic
TBA10010	F, between dep.hole 2 and 3	0,0	1,2	3 578	Pentronic
TBA10011	F, between dep.hole 2 and 3	0,0	-1,2	3 578	Pentronic
TBA10012	E, over dep.hole 3	-0,1	2,3	3 575	Pentronic
TBA10013	E, over dep.hole 3	0,0	1,3	3 575	Pentronic
TBA10014	E, over dep.hole 3	0,0	-0,9	3 575	Pentronic
TBA10015	E, over dep.hole 3	-0,5	-2,6	3 575	Pentronic
TBA10016	E, over dep.hole 3	0,5	-2,6	3 575	Pentronic
TBA10017	E, over dep.hole 3	-1,3	0,0	3 575	Pentronic
TBA10018	E, over dep.hole 3	1,3	0,0	3 575	Pentronic
TBA10019	F, between dep.hole 3 and 4	0,0	1,2	3 572	Pentronic
TBA10020	F, between dep.hole 3 and 4	0,0	-1,3	3 572	Pentronic

Table 4-12 Numbering and position of instruments for measuring total pressure (P) in the backfill

Type and number	Instrument position			Fabricate	Remark	
	Section	x	z			y
		m	m			m
PBA10001	Inner part	0,2	0,1	3589	Kulite	
PBA10002	E, over dep.hole 1	0,0	0,0	3587	Geokon	
PBA10003	E, over dep.hole 1	0,0	-1,8	3587	Geokon	
PBA10004	E, over dep.hole 1	0,0	-2,6	3587	Geokon	
PBA10005	E, over dep.hole 1	0,0	-3,1	3587	Kulite	
PBA10006	E, over dep.hole 1	-2,3	0,1	3587	Kulite	
PBA10007	E, over dep.hole 1	0,2	2,3	3587	Kulite	
PBA10008	F, between dep.hole 1 and 2	0,0	0,0	3584	Geokon	
PBA10009	F, between dep.hole 1 and 2	-0,1	-1,8	3584	Geokon	
PBA10010	F, between dep.hole 2 and 3	0,0	-0,2	3578	Kulite	
PBA10011	F, between dep.hole 2 and 3	0,0	-2,3	3578	Kulite	
PBA10013	E, over dep.hole 3	0,0	-1,8	3575	Kulite	
PBA10015	E, over dep.hole 3	0,0	-3,1	3575	Geokon	
PBA10016	E, over dep.hole 3	-2,3	0,0	3575	Geokon	
PBA10017	E, over dep.hole 3	0,0	0,0	3575	Geokon	
PBA10018	F, between dep.hole 3 and 4	0,0	0,0	3572	Geokon	
PBA10019	F, between dep.hole 3 and 4	0,0	-2,3	3572	Geokon	
PBA10020	In front of plug	0,0	0,0	3561	Kulite	

Table 4-13 Numbering and position of instruments for measuring pore water pressure (U) in the backfill

Type and number	Instrument position			Fabricate	Remark
	Section	x	z		
		m	m	m	
UBA10001	Inner part	-0,2	-0,1	3589	Kulite
UBA10002	Inner part	0,0	0,0	3592	Geokon
UBA10003	Inner part	-0,2	-0,1	3590	Geokon
UBA10004	E, over dep.hole 1	0,0	-0,1	3587	Geokon
UBA10005	E, over dep.hole 1	-0,2	-1,8	3587	Kulite
UBA10006	E, over dep.hole 1	0,1	-2,6	3587	Kulite
UBA10007	E, over dep.hole 1	0,4	-3,2	3587	Kulite
UBA10008	E, over dep.hole 1	-2,3	0,0	3587	Geokon
UBA10009	E, over dep.hole 1	0,0	2,3	3587	Geokon
UBA10010	F, between dep.hole 1 and 2	0,0	0,0	3584	Kulite
UBA10011	F, between dep.hole 1 and 2	0,1	-1,8	3584	Kulite
UBA10012	F, between dep.hole 2 and 3	0,0	-0,2	3578	Kulite
UBA10013	F, between dep.hole 2 and 3	0,0	-2,3	3578	Kulite
UBA10014	E, over dep.hole 3	0,0	0,0	3575	Kulite
UBA10015	E, over dep.hole 3	0,0	-1,8	3575	Geokon
UBA10016	E, over dep.hole 3	0,3	-2,6	3575	Geokon
UBA10017	E, over dep.hole 3	-0,1	-3,1	3575	Geokon
UBA10018	E, over dep.hole 3	-2,3	0,0	3575	Geokon
UBA10019	E, over dep.hole 3	0,0	0,0	3575	Geokon
UBA10020	F, between dep.hole 3 and 4	0,0	0,0	3572	Kulite
UBA10021	F, between dep.hole 3 and 4	0,0	-2,3	3572	Kulite
UBA10022	In front of plug	0,0	0,0	3565	Kulite
UBA10023	In front of plug	0,1	0,0	3562	Kulite

Table 4-14 Numbering and position of instruments for measuring relative humidity (W) in the backfill

Type and number	Instrument position			Fabricate	Remark
	Section	x	z		
		m	m	m	
WBA10001	Inner part	0,0	0,0	3589	Wescor
WBA10002	Inner part	0,0	0,0	3592	Wescor
WBA10003	Inner part	0,1	-0,1	3590	Wescor
WBA10004	E, over dep.hole 1	0,3	2,3	3587	Wescor
WBA10005	E, over dep.hole 1	0,0	1,3	3587	Wescor
WBA10006	E, over dep.hole 1	0,0	0,1	3587	Wescor
WBA10007	E, over dep.hole 1	0,1	-0,8	3587	Wescor
WBA10008	E, over dep.hole 1	0,0	-1,7	3587	Wescor
WBA10009	E, over dep.hole 1	-0,1	-2,6	3587	Wescor
WBA10010	E, over dep.hole 1	-0,5	-3,1	3587	Wescor
WBA10011	E, over dep.hole 1	-2,3	-0,1	3587	Wescor
WBA10012	E, over dep.hole 1	-1,3	0,0	3587	Wescor
WBA10013	E, over dep.hole 1	1,3	0,0	3587	Wescor
WBA10014	E, over dep.hole 1	2,3	0,0	3587	Wescor
WBA10015	F, between dep.hole 1 and 2	0,0	1,3	3584	Wescor
WBA10016	F, between dep.hole 1 and 2	0,0	2,3	3584	Wescor
WBA10017	F, between dep.hole 1 and 2	0,0	0,0	3584	Wescor
WBA10018	F, between dep.hole 1 and 2	0,0	-1,3	3584	Wescor
WBA10019	F, between dep.hole 1 and 2	-1,3	0,0	3584	Wescor
WBA10020	F, between dep.hole 1 and 2	1,3	0,0	3584	Wescor
WBA10021	F, between dep.hole 2 and 3	0,0	2,3	3578	Wescor
WBA10022	F, between dep.hole 2 and 3	0,0	1,2	3578	Wescor
WBA10023	F, between dep.hole 2 and 3	0,0	-0,2	3578	Wescor
WBA10024	F, between dep.hole 2 and 3	0,0	-1,2	3578	Wescor
WBA10025	F, between dep.hole 2 and 3	-1,3	0,0	3578	Wescor
WBA10026	F, between dep.hole 2 and 3	1,3	0,0	3578	Wescor
WBA10027	E, over dep.hole 3	0,0	2,5	3575	Wescor
WBA10028	E, over dep.hole 3	0,0	1,3	3575	Wescor
WBA10029	E, over dep.hole 3	0,0	0,0	3575	Wescor
WBA10030	E, over dep.hole 3	0,0	-0,9	3575	Wescor
WBA10031	E, over dep.hole 3	0,0	-1,6	3575	Wescor
WBA10032	E, over dep.hole 3	-0,3	-2,6	3575	Wescor
WBA10033	E, over dep.hole 3	0,1	-3,1	3575	Wescor
WBA10034	E, over dep.hole 3	-2,3	0,0	3575	Wescor
WBA10035	E, over dep.hole 3	-1,3	0,0	3575	Wescor
WBA10036	E, over dep.hole 3	1,3	0,0	3575	Wescor
WBA10037	E, over dep.hole 3	2,3	0,0	3575	Wescor
WBA10038	F, between dep.hole 3 and 4	0,0	2,3	3572	Wescor
WBA10039	F, between dep.hole 3 and 4	0,0	1,2	3572	Wescor
WBA10040	F, between dep.hole 3 and 4	0,0	0,0	3572	Wescor
WBA10041	F, between dep.hole 3 and 4	0,0	-1,3	3572	Wescor
WBA10042	F, between dep.hole 3 and 4	-1,3	0,0	3572	Wescor
WBA10043	F, between dep.hole 3 and 4	1,3	0,0	3572	Wescor
WBA10044	In front of plug	0,0	0,0	3565	Wescor
WBA10045	In front of plug	-0,1	0,0	3562	Wescor

Appendix 1

Dep. hole 1

Prototype\Hole 1\Cyl.1 (010917-030601)

Total pressure - Geokon

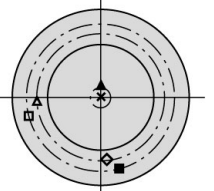
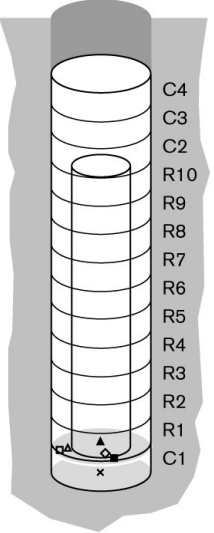
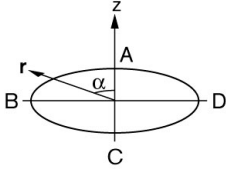
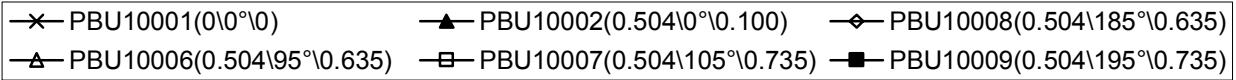
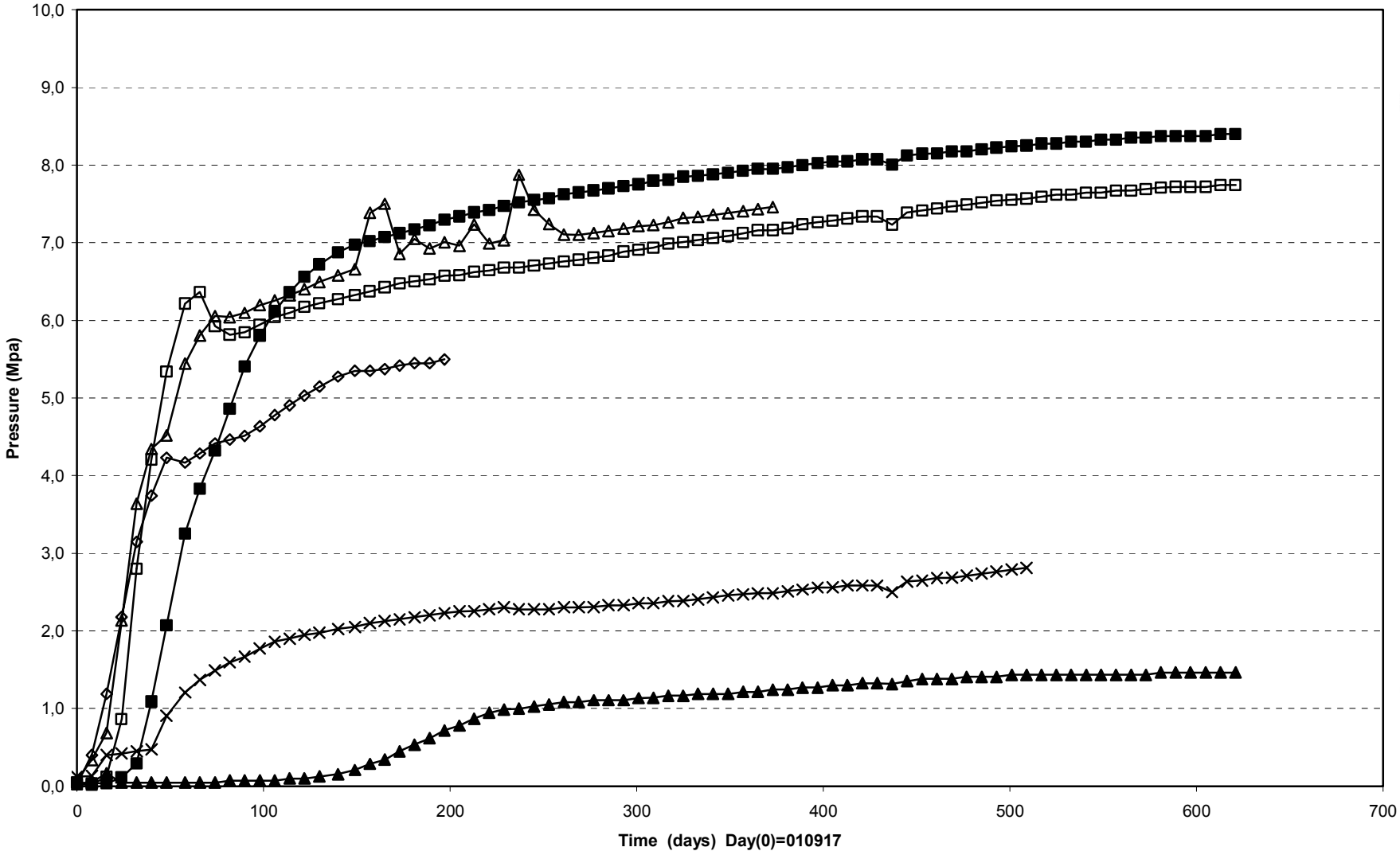

Prototype\Hole 1\Ring5 (010917-030601)
 Total pressure - Geokon

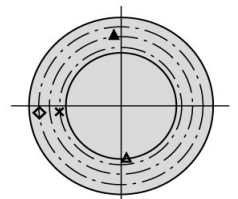
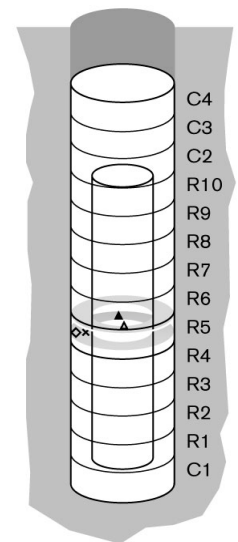
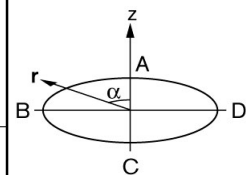
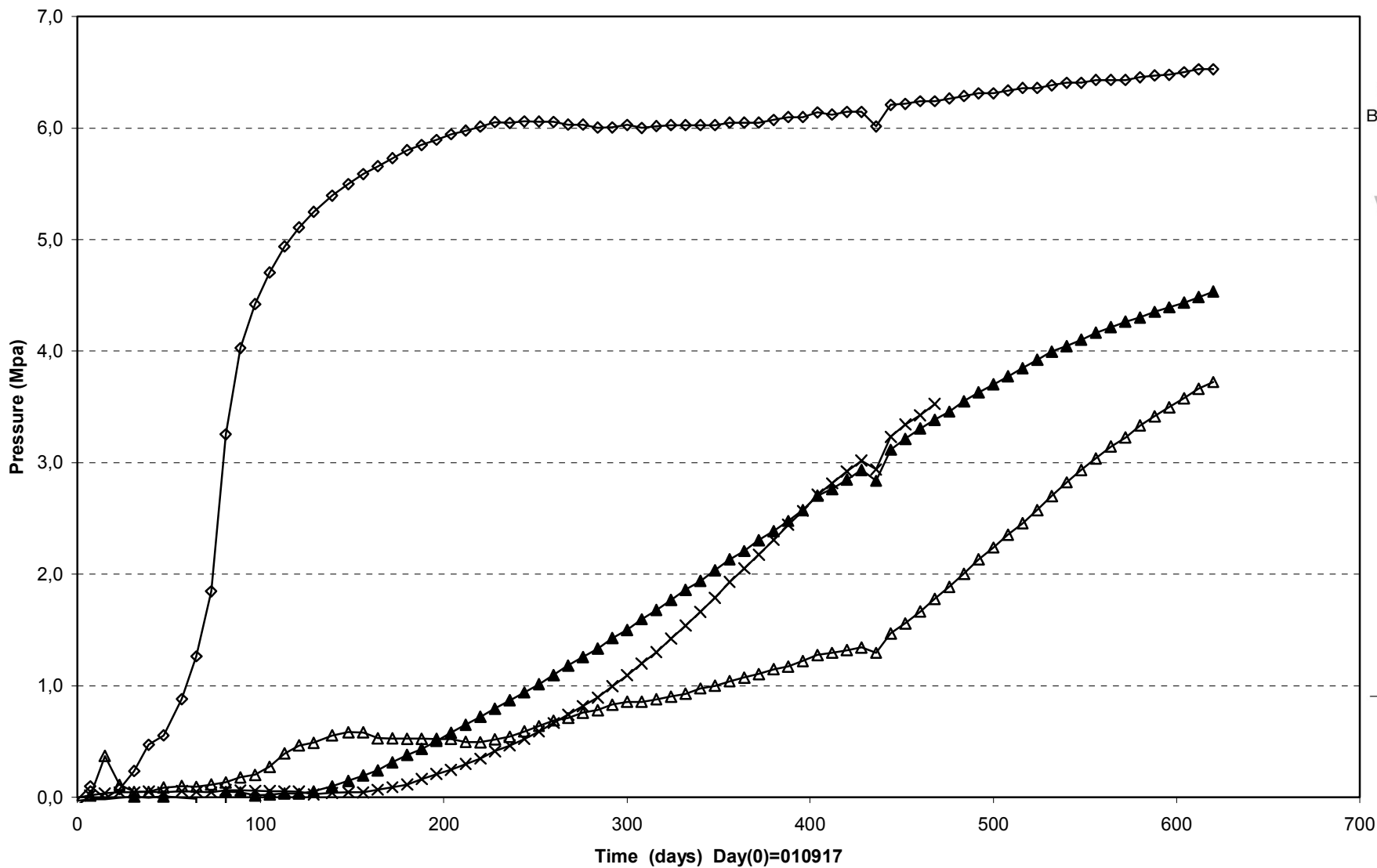

—x— PBU10013(2.780\95°\0.585) —▲— PBU10011(2.780\5°\0.685) —◇— PBU10014(2.780\95°\0.785) —△— PBU10015(3.030\185°\0.535)

PrototypeHole 1\ Ring10 and Cyl.3 (010917-030601)
Total pressure - Geokon

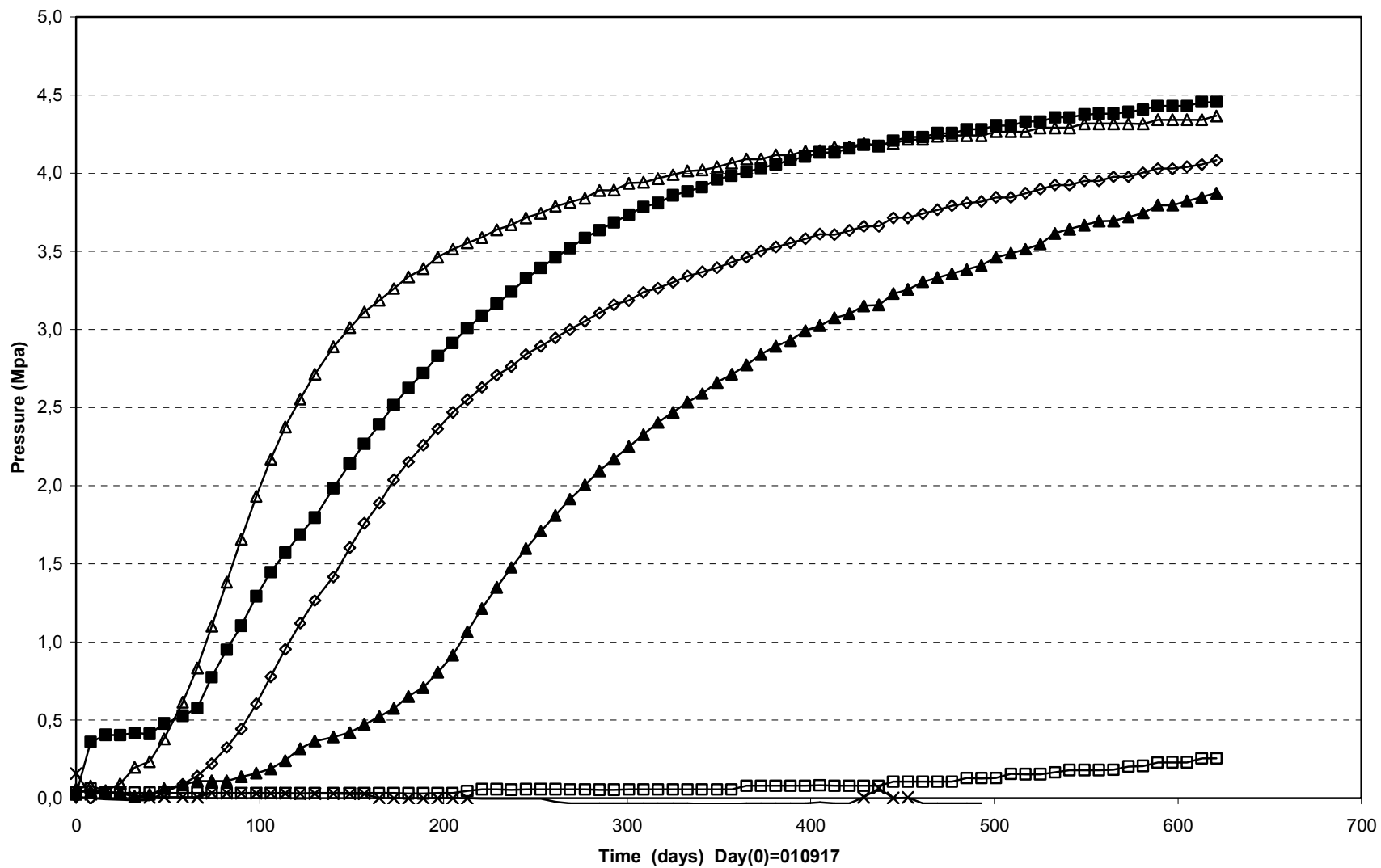

✕ PBU10017(5.558\0°\0.050)	▲ PBU10021(5.558\90°\0.635)	◇ PBU10022(5.558\100°\0.735)
△ PBU10023(5.558\190°\0.735)	□ PBU10026(6.567\5°\0.585)	■ PBU10024(5.558\180°\0.635)

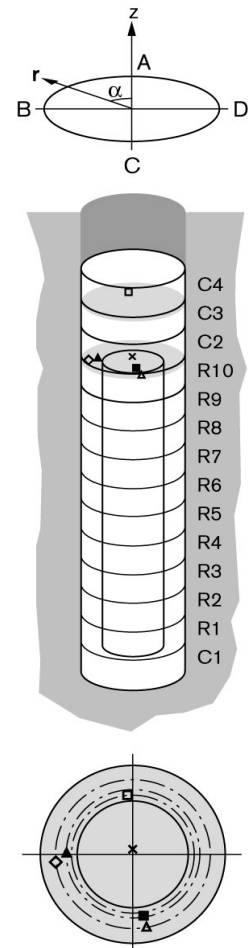

Prototype\ Hole 1 (010917-030601)

Total pressure - Kulite

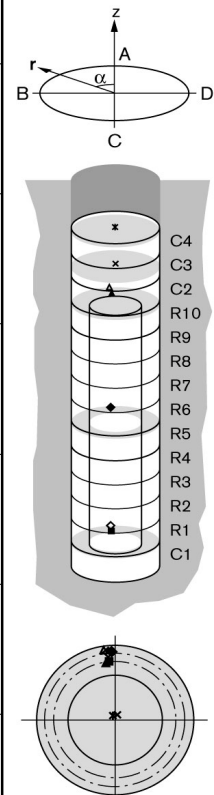
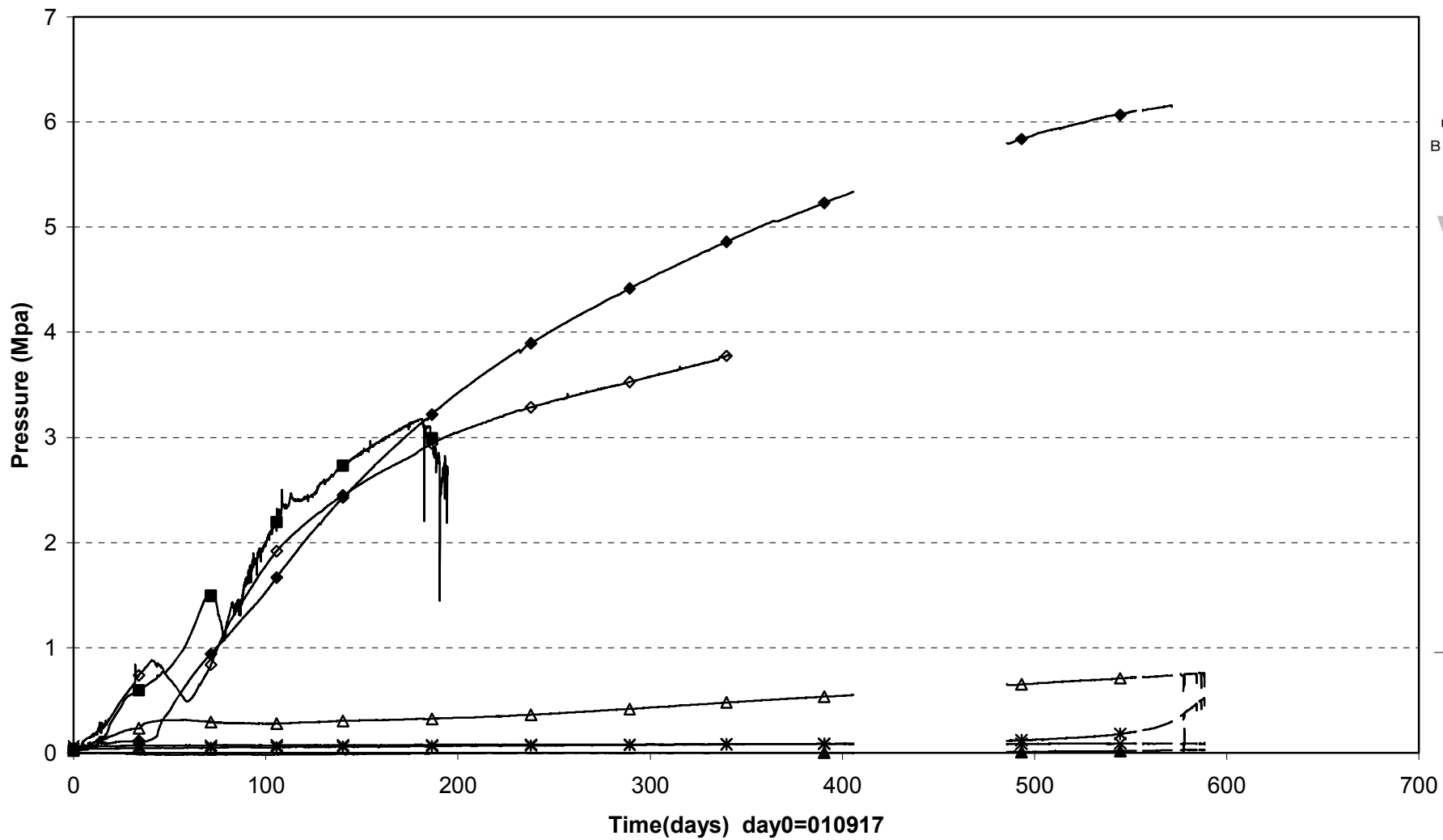

■ PBU10004(0.504\5°\0.685) ◇ PBU10005(0.504\5°\0.785) ◆ PBU10012(3.030\5°\0.785) ▲ PBU10019(5.558\5°\0.685)
 △ PBU10020(5.558\5°\0.785) × PBU10025(6.317\0°\0.050) * PBU10027(7.076\0°\0.050)

Prototype\Hole 1\Cyl.1 (010917-030601)
Relative humidity - Vaisala

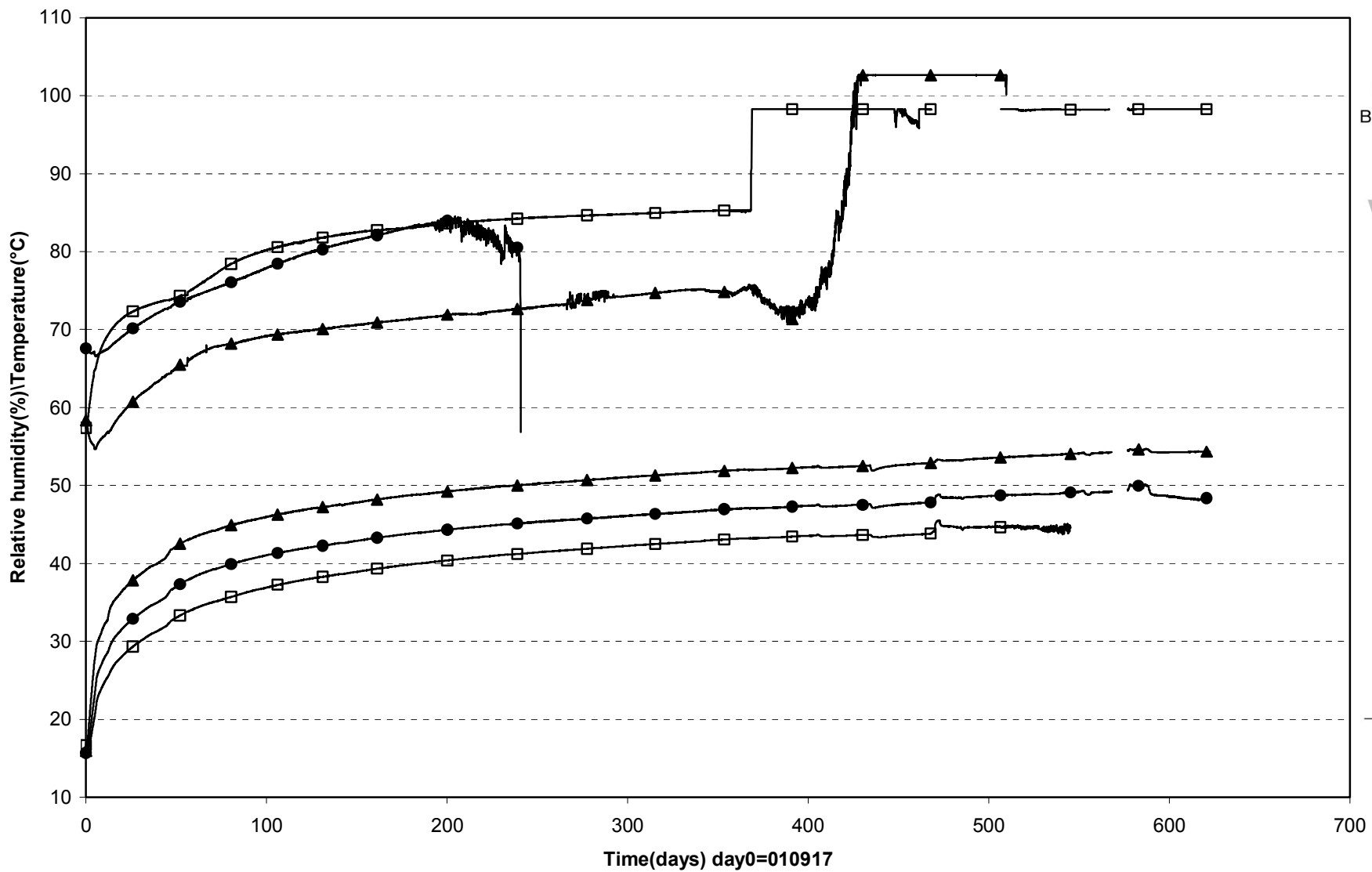

□ WBU10004(0.344\350°\0.785) ● WBU10005(0.344\350°\0.685) ▲ WBU10006(0.344\350°\0.585)

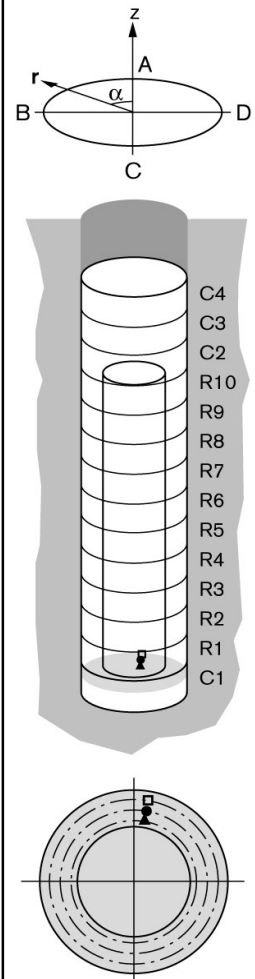

Prototype\Hole 1\Ring.5 (010917-030601)
Relative humidity - Vaisala

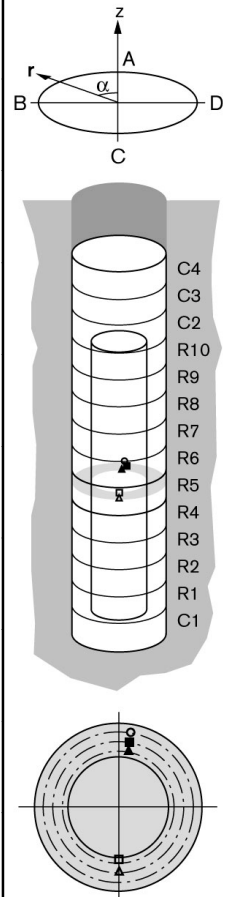
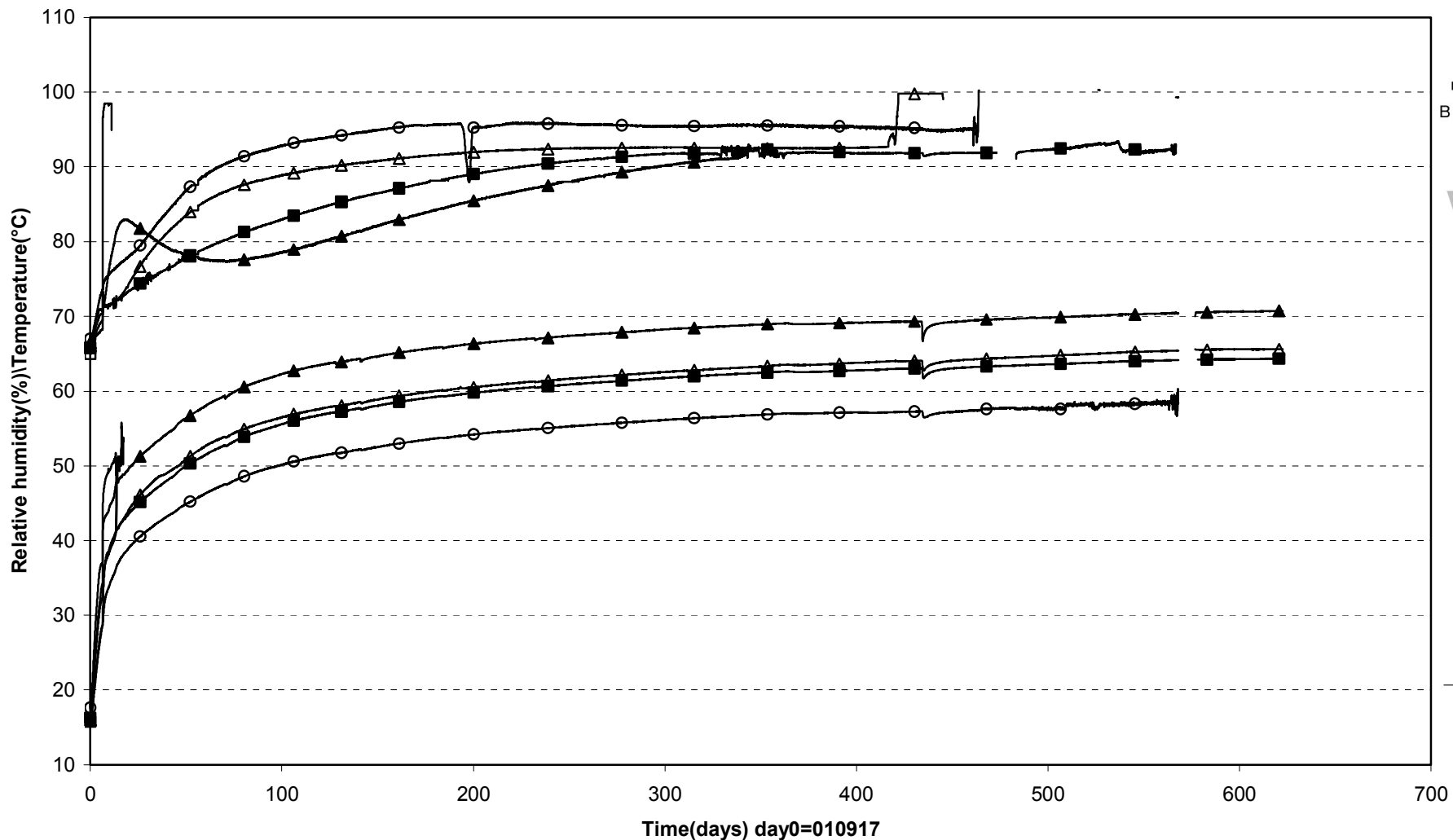

▲ WBU10013(2.870\350°\0.585)	■ WBU10014(2.870\350°\0.685)	○ WBU10015(2.870\350°\0.785)
□ WBU10019(2.870\180°\0.535\In the slot)	△ WBU10020(2.870\180°\0.685)	

Prototype\Hole 1\Ring10 (010917-030601)

Relative humidity - Vaisala

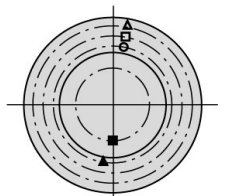
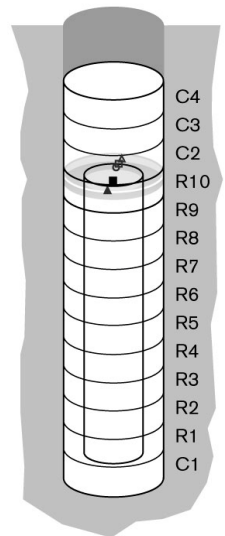
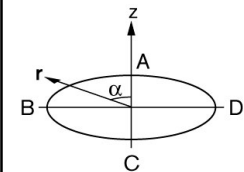
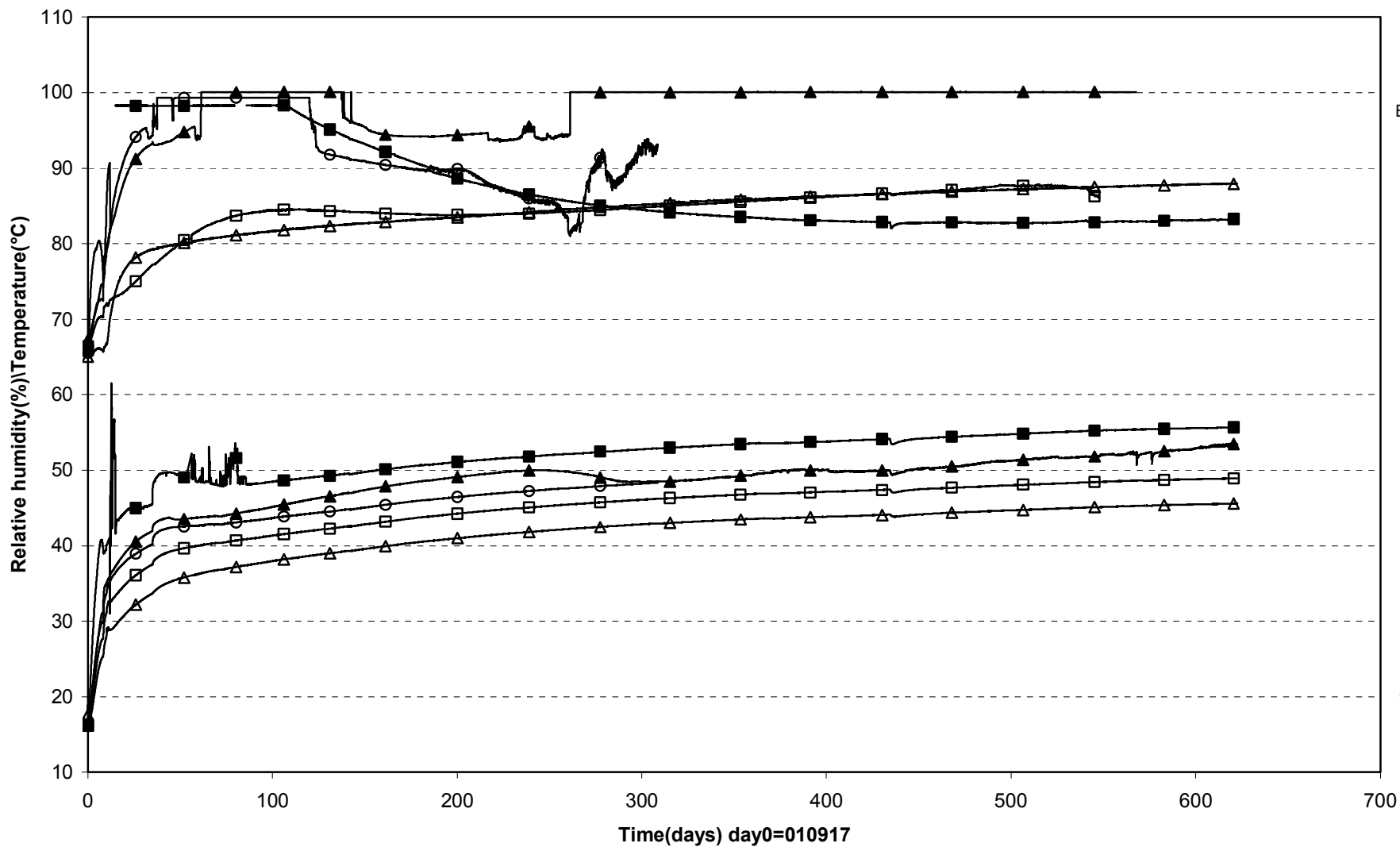

WBU10023(5.428\180°\0.362)
 WBU10024(5.398\350°\0.585)
 WBU10025(5.398\350°\0.685)
 WBU10026(5.398\350°\0.785)
 WBU10030(5.398\170°\0.585)

Prototype\Hole 1\Cyl.3 and Cyl.4 (010917-030601)
 Relative humidity - Vaisala

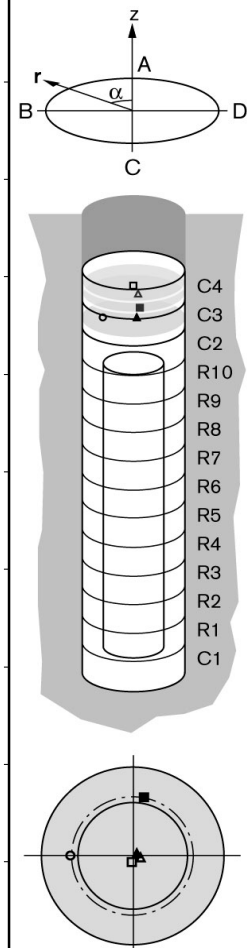
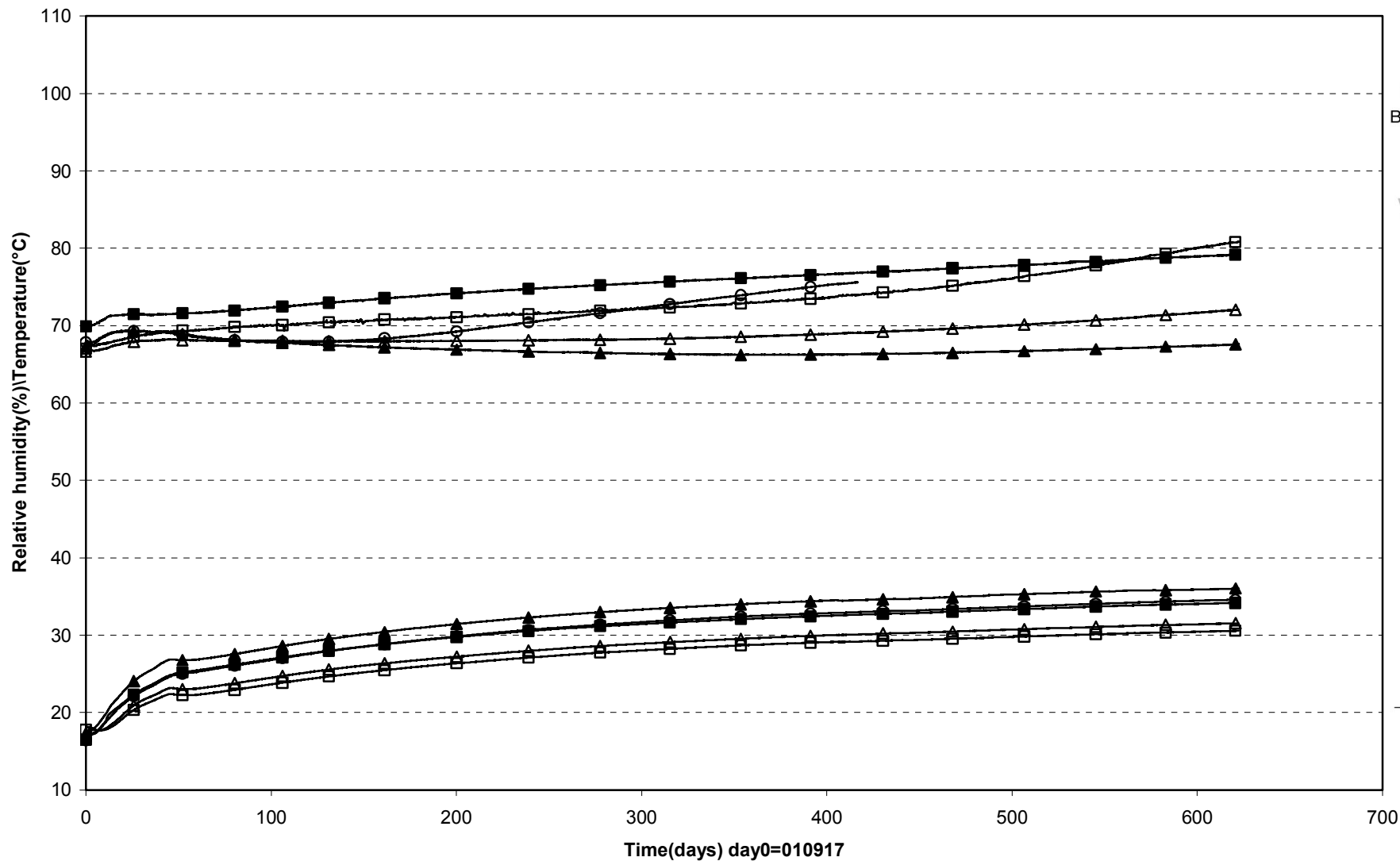

▲ WBU10032(6.317\270°\0.050) ■ WBU10033(6.317\350°\0.585) ○ WBU10034(6.317\90°\0.585) □ WBU10036(6.916\180°\0.050) △ WBU10037(6.756\270°\0.050)

Prototyp\Hole 1\Cyl.1 (010917-030601)
 Relative humidity - Rotronic

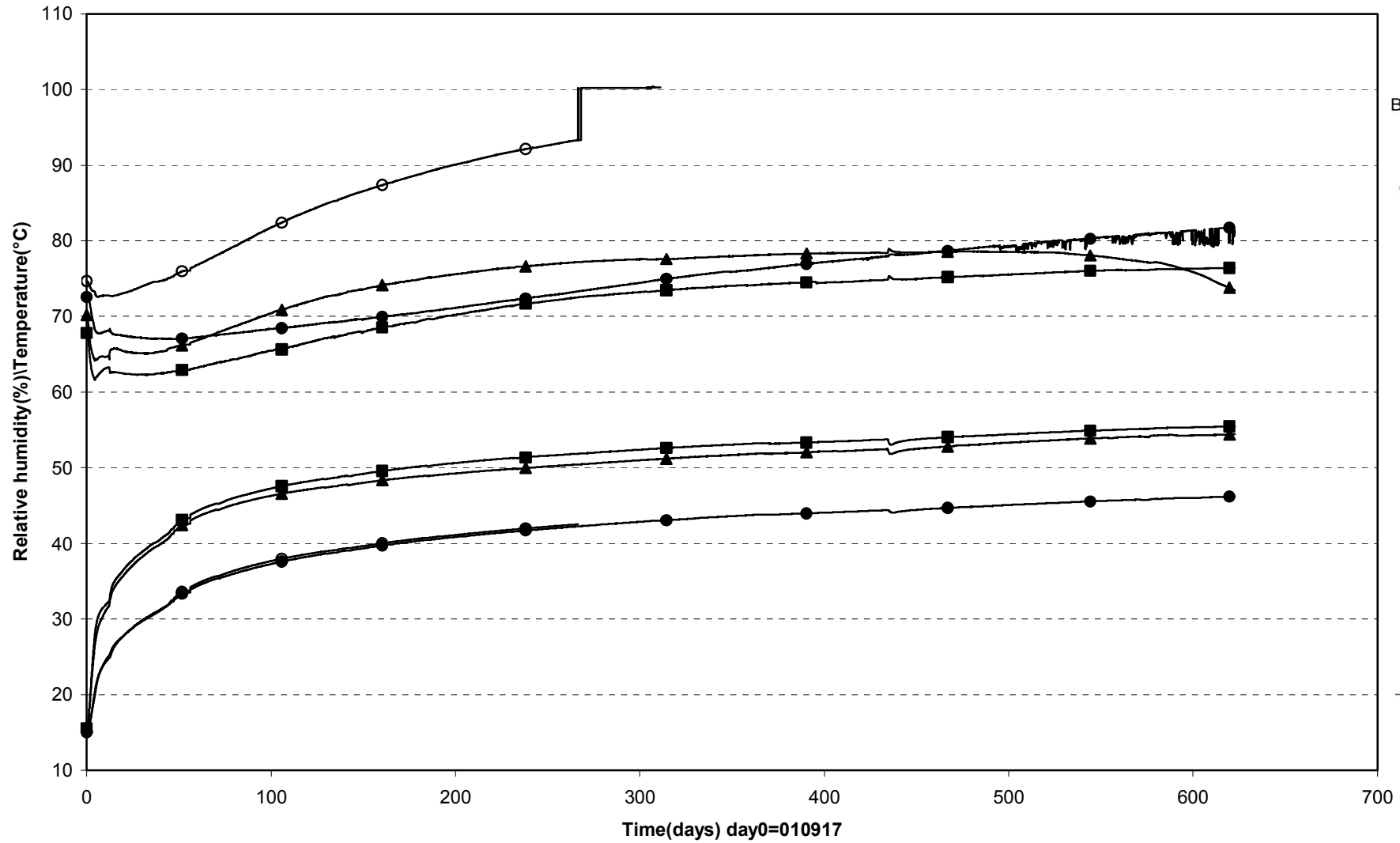

● WBU10001 (0.054\180°\0.050) ▲ WBU10002 (0.254\0°\0.400) ■ WBU10003 (0.254\180°\0.100) ○ WBU10008(0.254\80°\0.685)

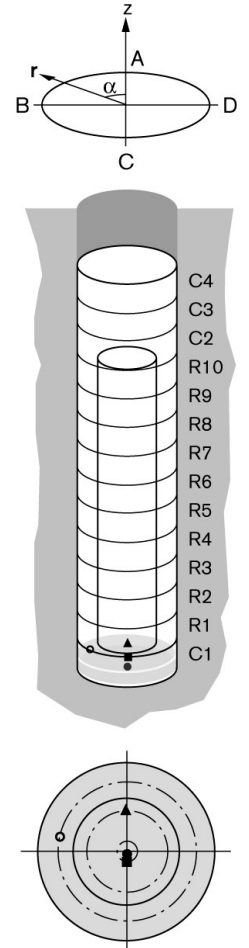

Prototyp\Hole 1\Cyl.1 (010917-030601)
Relative humidity - Rotronic

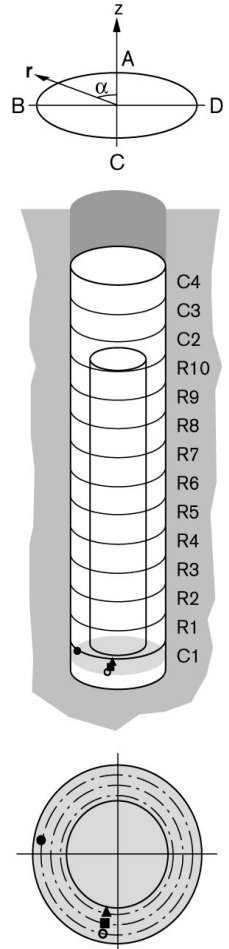
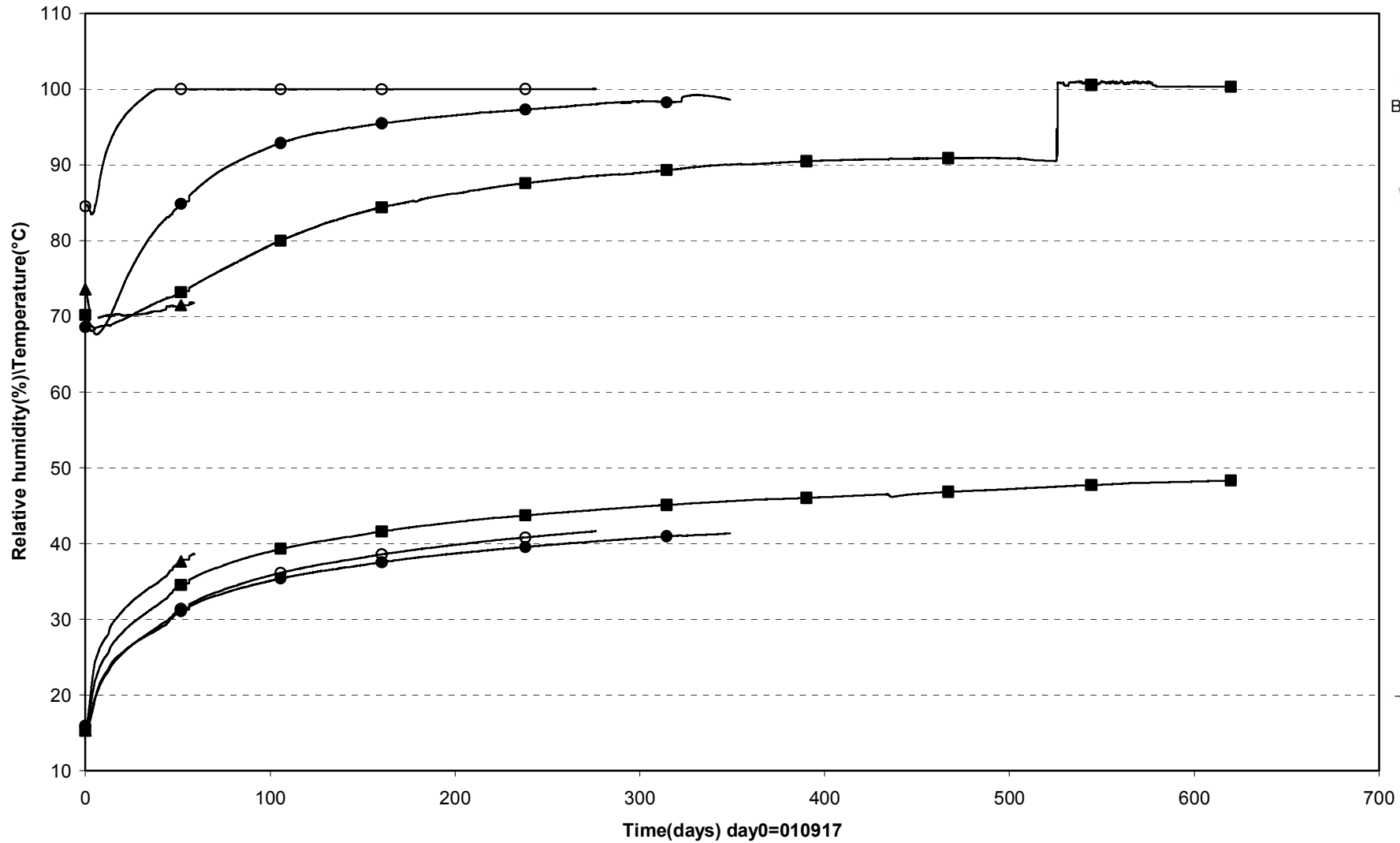

● WBU10009(0.254\80°\0.785) ▲ WBU10010(0.254\170°\0.585) ■ WBU10011(0.254\170°\0.685) ○ WBU10012(0.254\170°\0.785)

Prototyp\Hole 1\Ring.5 (010917-030601)
Relative humidity - Rotronic

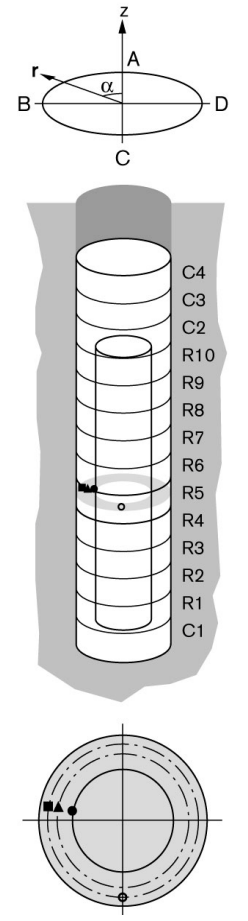
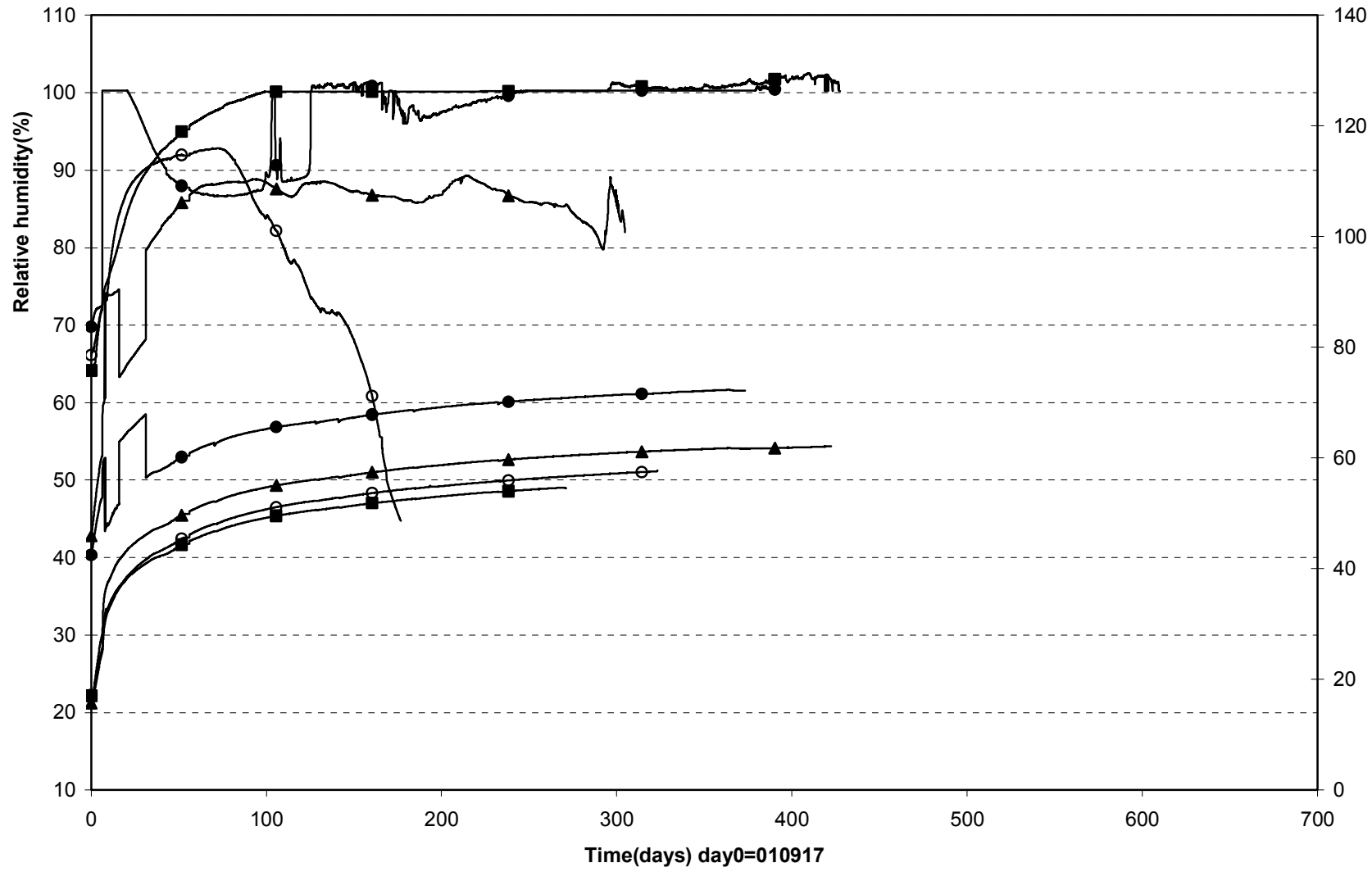

● WBU10016(2.780\80°\0.535) ▲ WBU10017(2.780\80°\0.685) ■ WBU10018(2.780\80°\0.785) ○ WBU10021(2.780\180°\0.785)

Prototyp\Hole 1\Ring10 (010917-030601)
Relative humidity - Rotronic

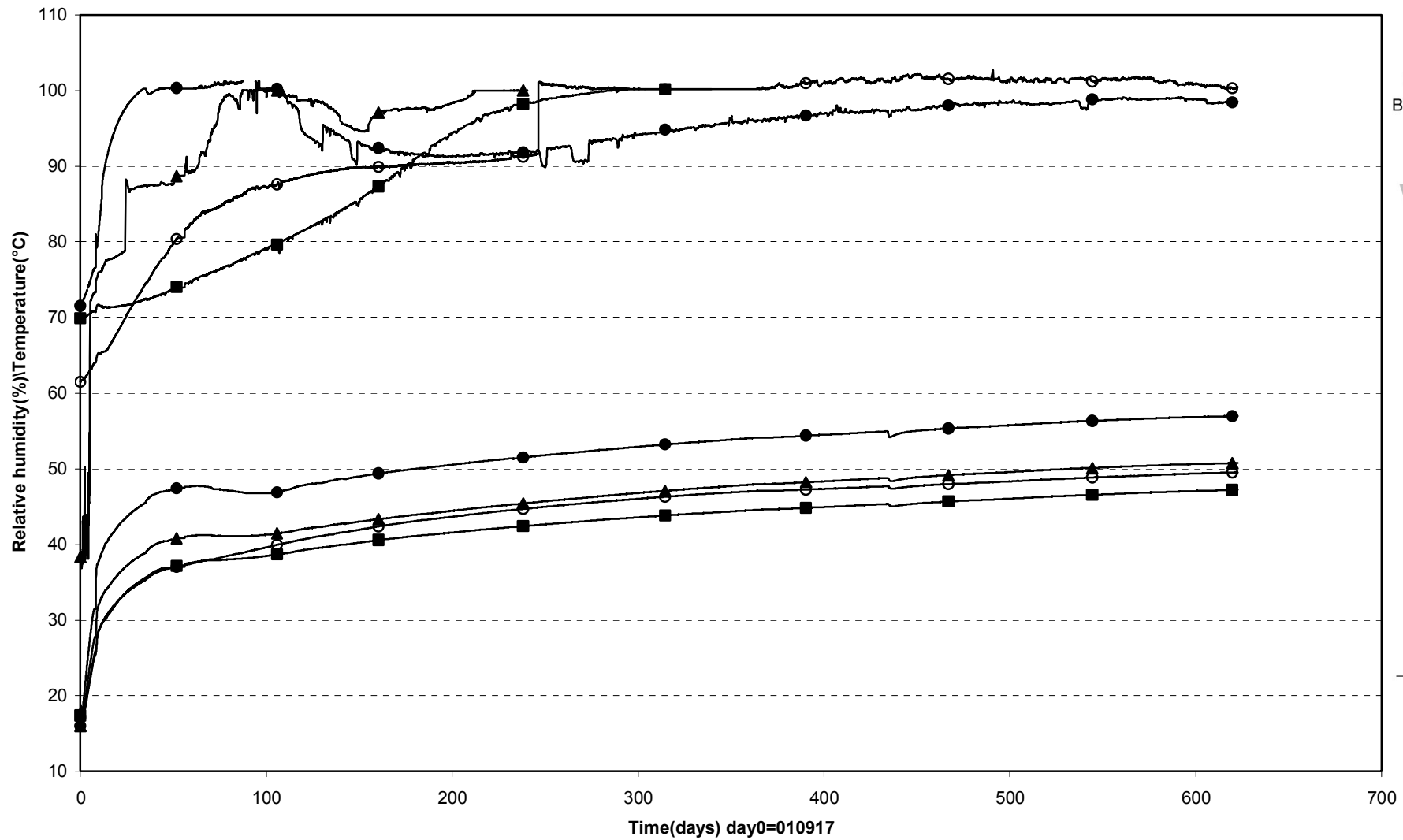

● WBU10027(5.308\80°\0.585) ▲ WBU10028(5.308\80°\0.685) ■ WBU10029(5.308\80°\0.785) ○ WBU10031(5.308\170°\0.785)

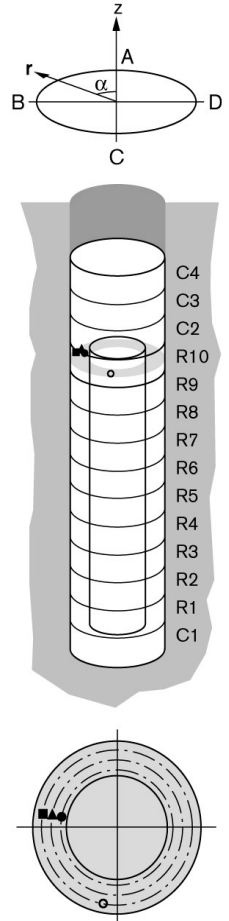

Prototyp\Hole 1\Cyl.3 (010917-030601)
 Relative humidity - Rotronic

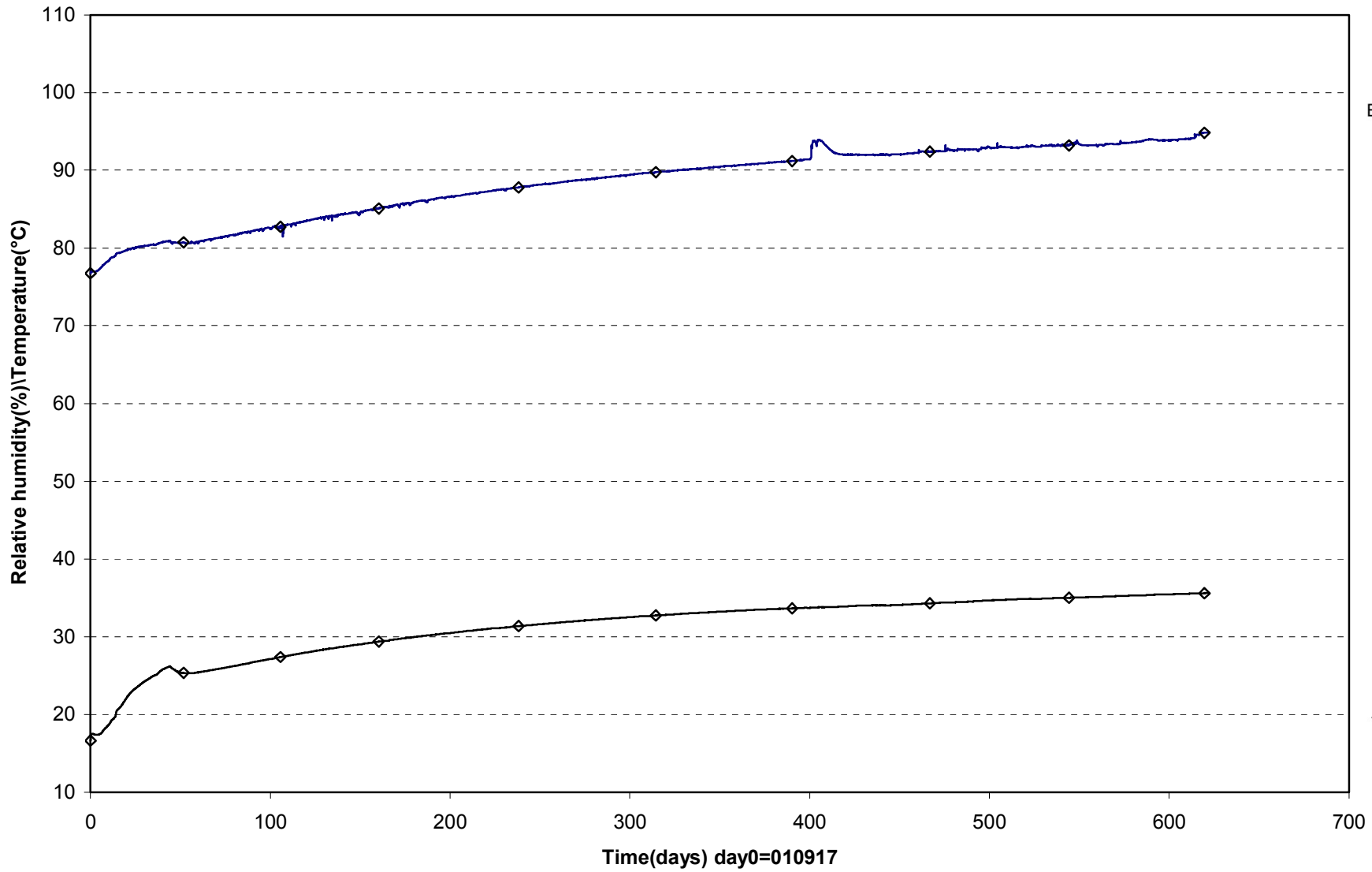

◇ WBU10035(6.317\180°\0.585)

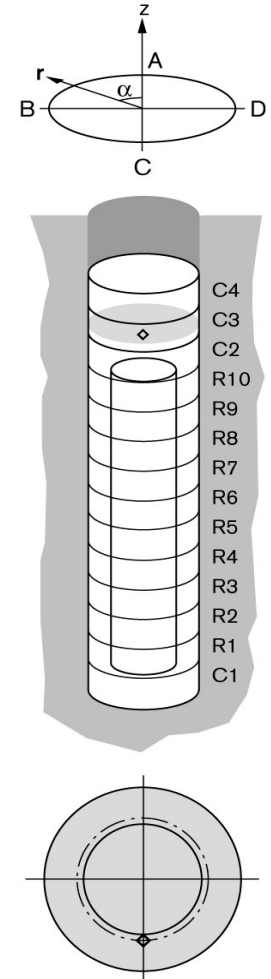

Prototype\Hole 1 (010917-030601)
Pore pressure - Geokon

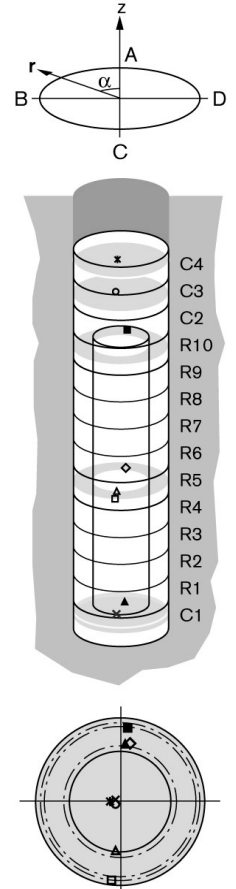
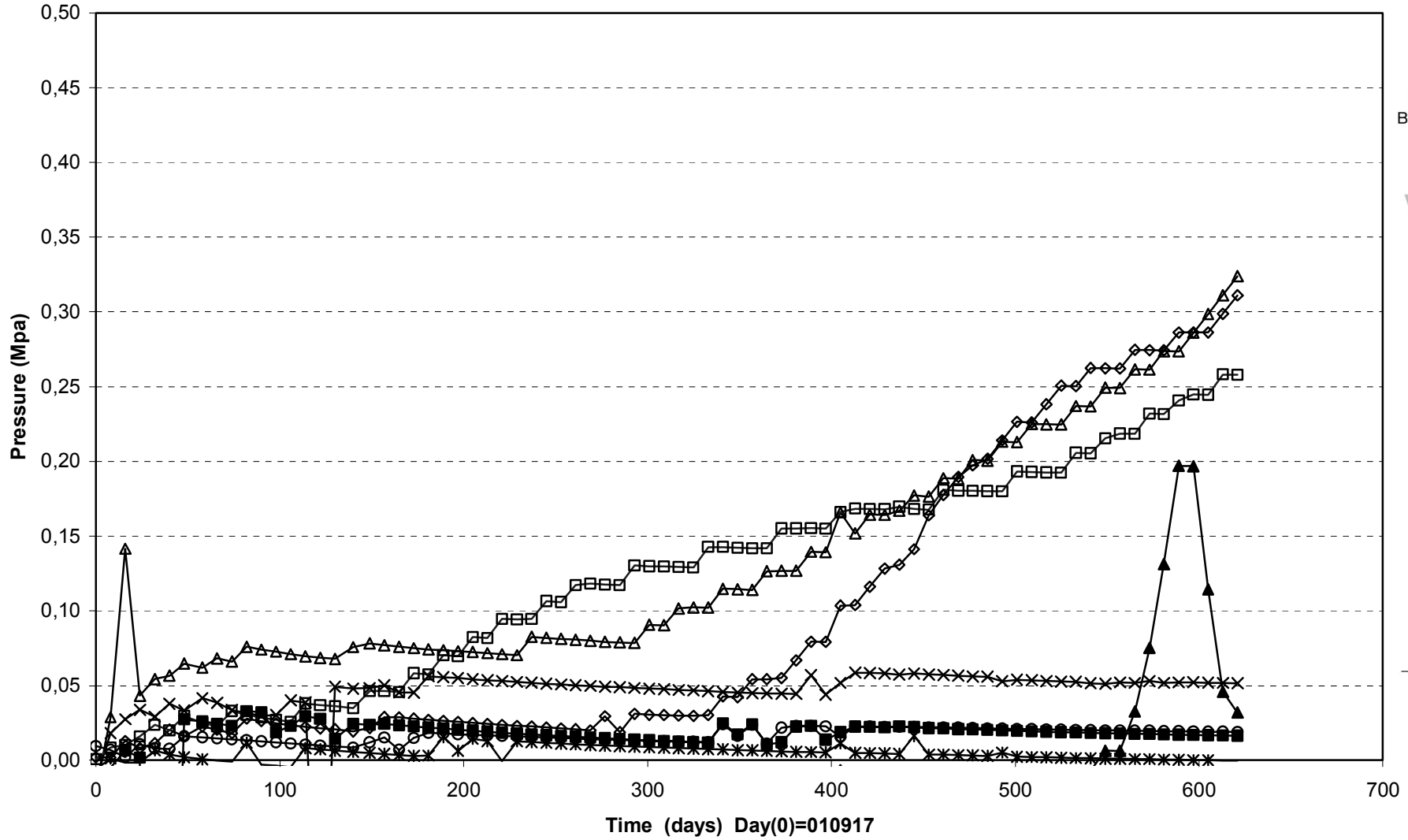

—x— UBU10002(0.254\90°\0.100)	—▲— UBU10003(0.344\355°\0.585)	—◇— UBU10005(2.780\355°\0.585)	—△— UBU10009(2.780\175°\0.535\)
—□— UBU10010(2.780\175°\0.825)	—■— UBU10012(5.308\355°\0.785)	—○— UBU10013(6.317\90°\0.050)	—*— UBU10014(6.916\90°\0.050)

Prototype\ Hole 1 (010917-030601)
Pore pressure - Kulite

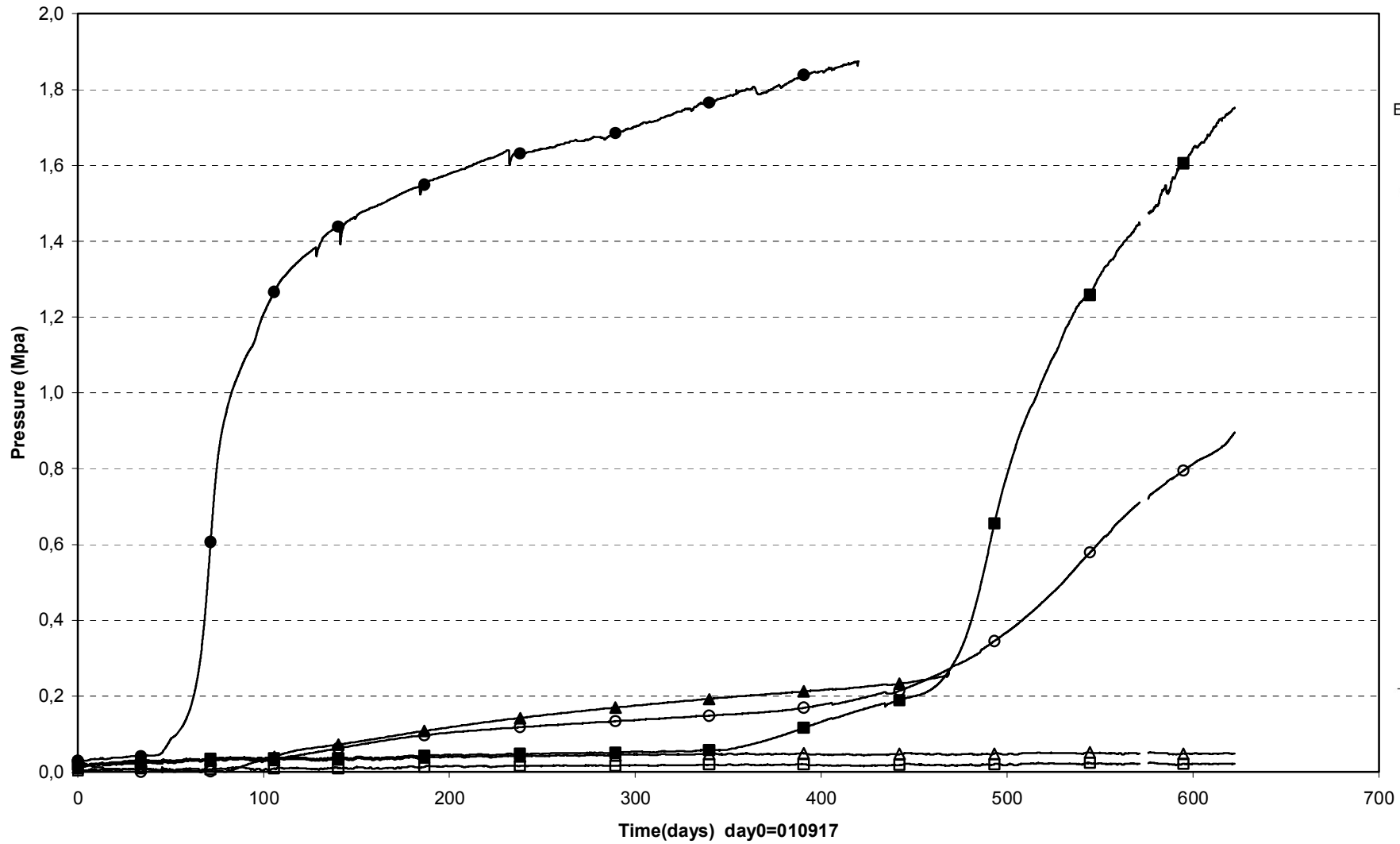

□ UBU10001(0.054\90°\0.050) ▲ UBU10004(0.344\355°\0.785) ○ UBU10006(2.870\355°\0.785)
 ■ UBU10007(2.870\85°\0.535\In the slot) ● UBU10008(2.870\85°\0.825\In the slot) △ UBU100011(5.398\355°\0.585)

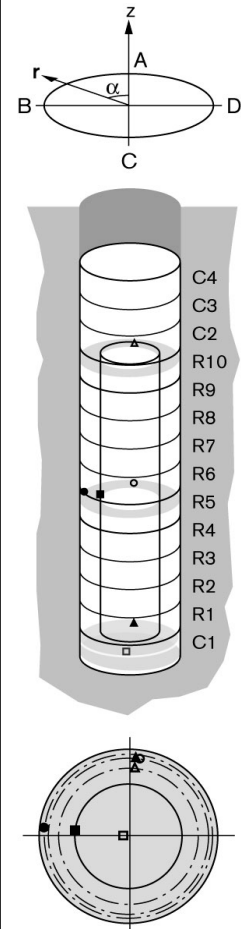

Prototype\Hole 1\Cyl.1 (010917-030601)
 Temperature - Pentronic

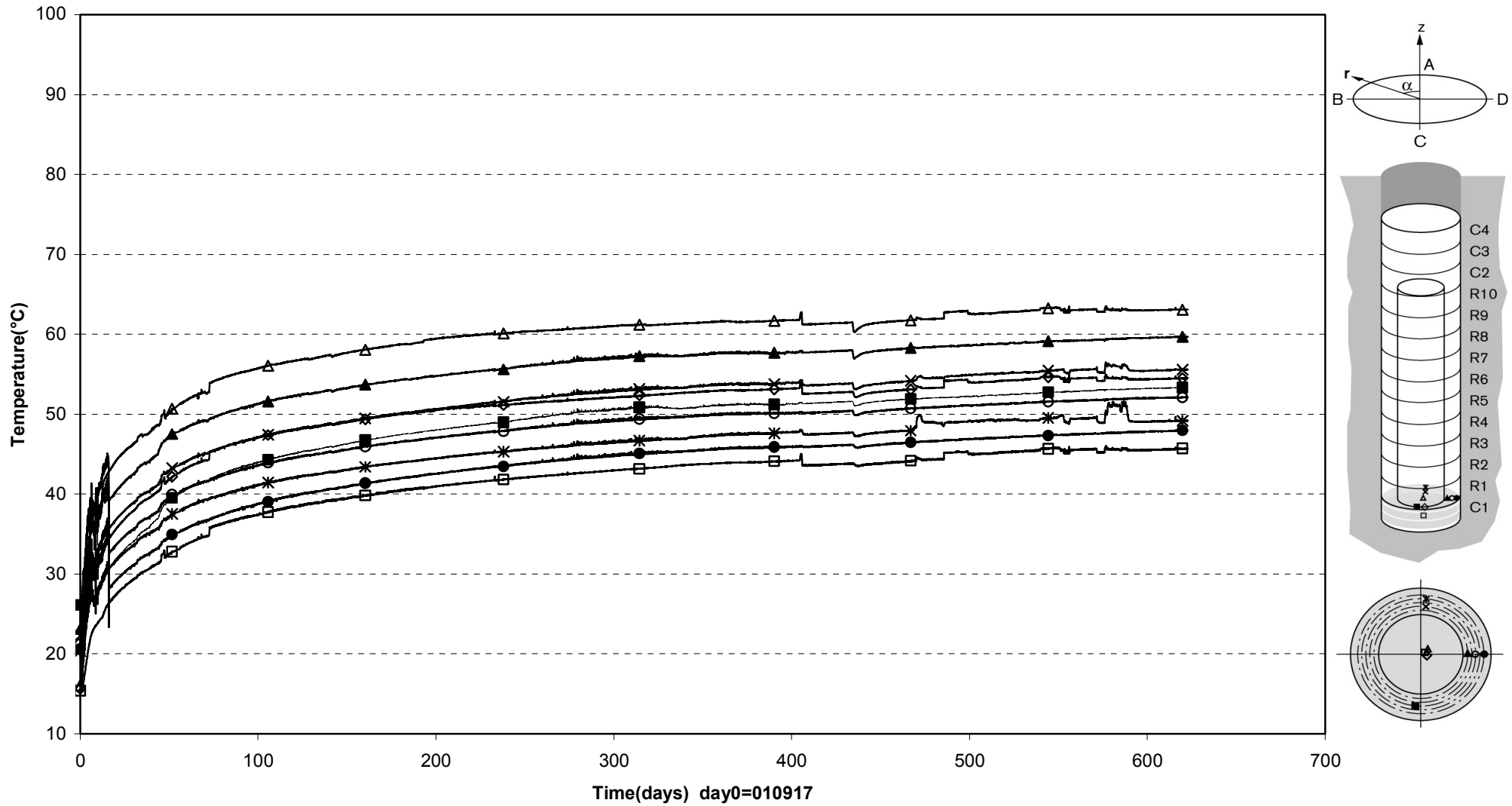

- | | | | | |
|------------------------------|------------------------------|------------------------------|------------------------------|------------------------------|
| □ TBU10001(0.054\270°\50) | ◇ TBU10002(0.254\270°\0.050) | △ TBU10003(0.454\270°\0.050) | × TBU10004(0.454\355°\0.635) | ✱ TBU10005(0.454\355°\0.735) |
| ■ TBU10007(0.454\175°\0.685) | ▲ TBU10008(0.454\270°\0.585) | ○ TBU10009(0.454\270°\0.685) | ● TBU10010(0.454\270°\0.785) | |

Prototype\Hole 1 \Ring5 (010917-030601)
 Temperature - Pentronic

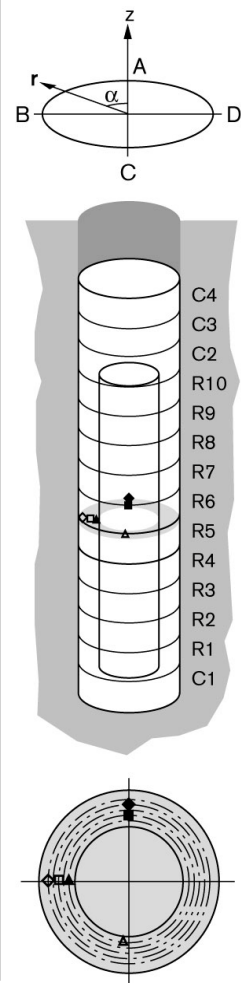
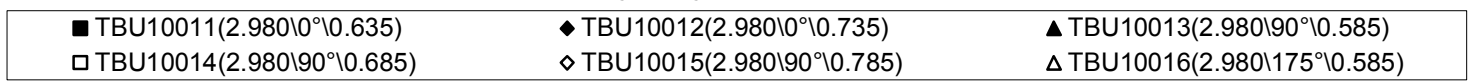
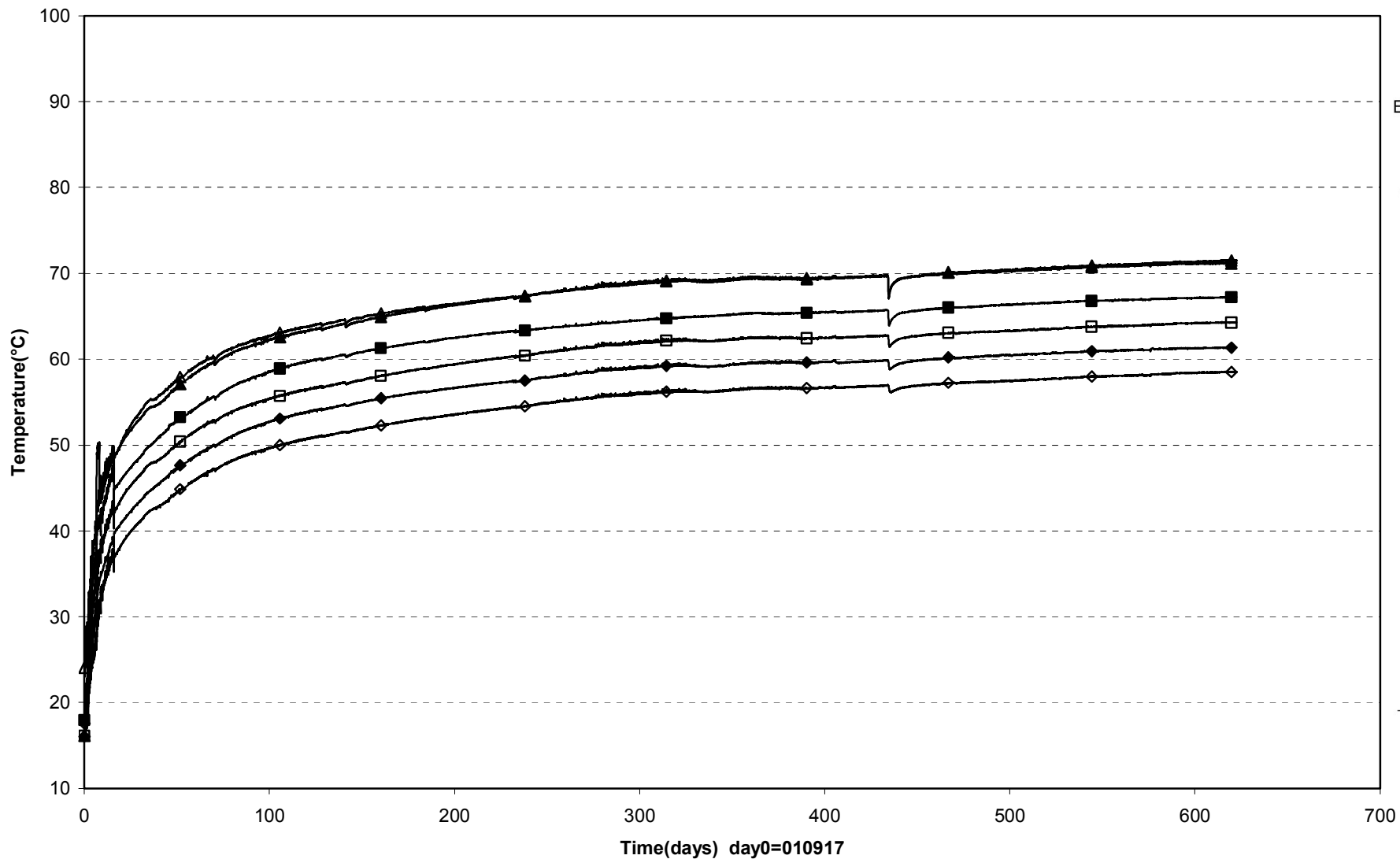

Prototype\Hole 1 \Ring5 (010917-030601)
 Temperature - Pentronic

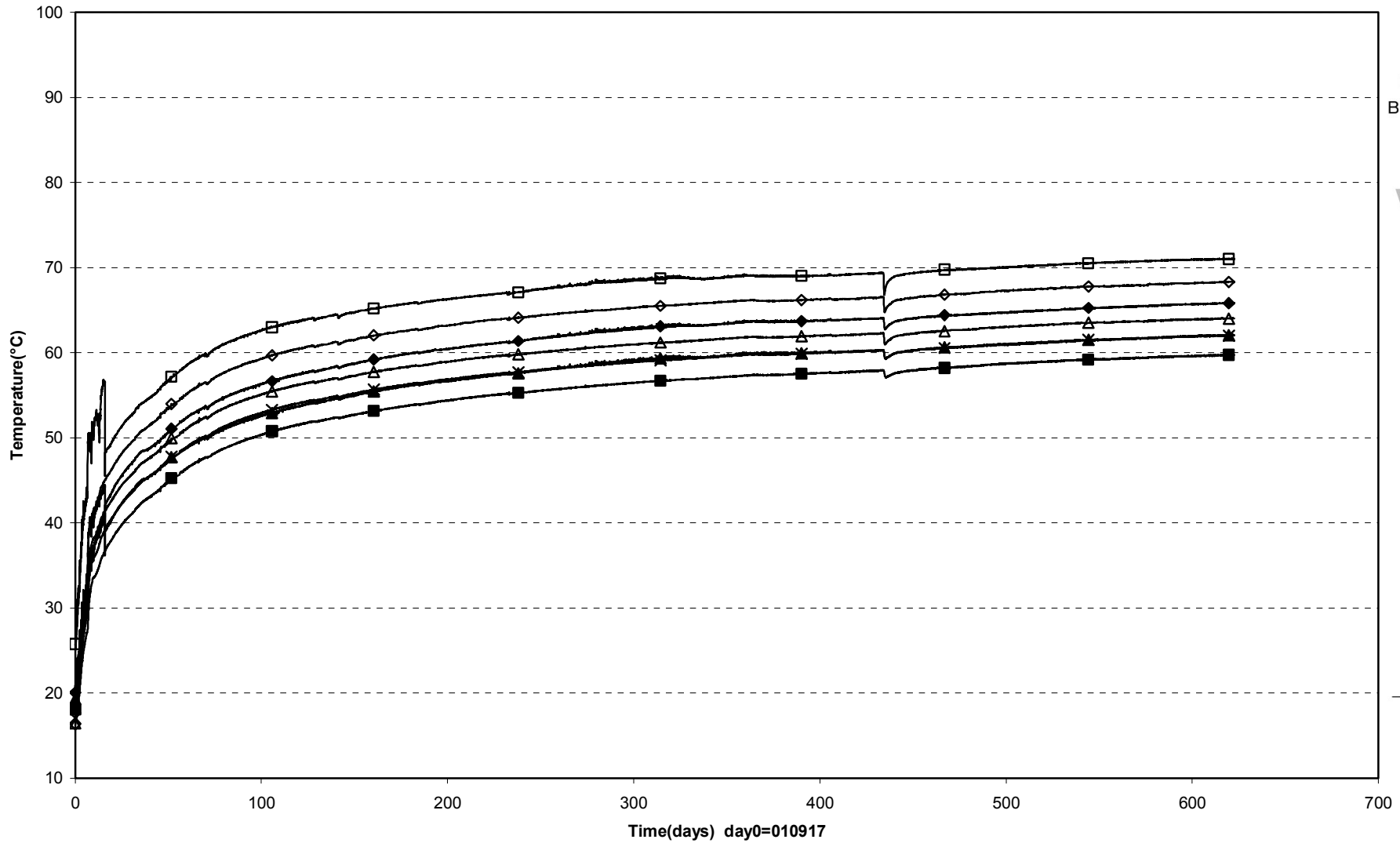

◆ TBU10017(2.980\175°\0.685) ▲ TBU10018(2.980\175°\0.735) □ TBU10019(2.980\270°\0.585) ◇ TBU10020(2.980\270°\0.635)
 △ TBU10021(2.980\270°\0.685) × TBU10022(2.980\270°\0.735) ■ TBU10023(2.980\270°\0.785)

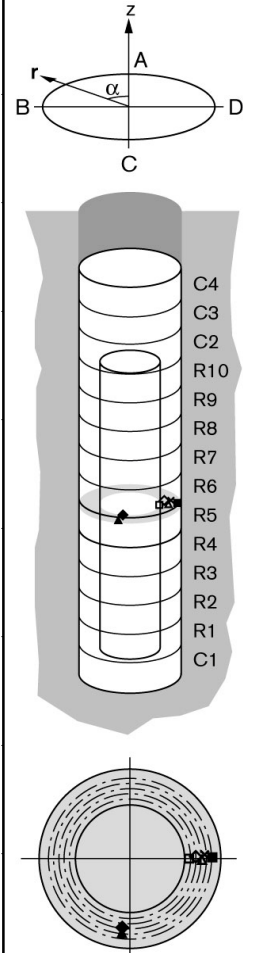

Prototype\Hole 1 \Ring10 (010917-030601)
 Temperature - Pentronic

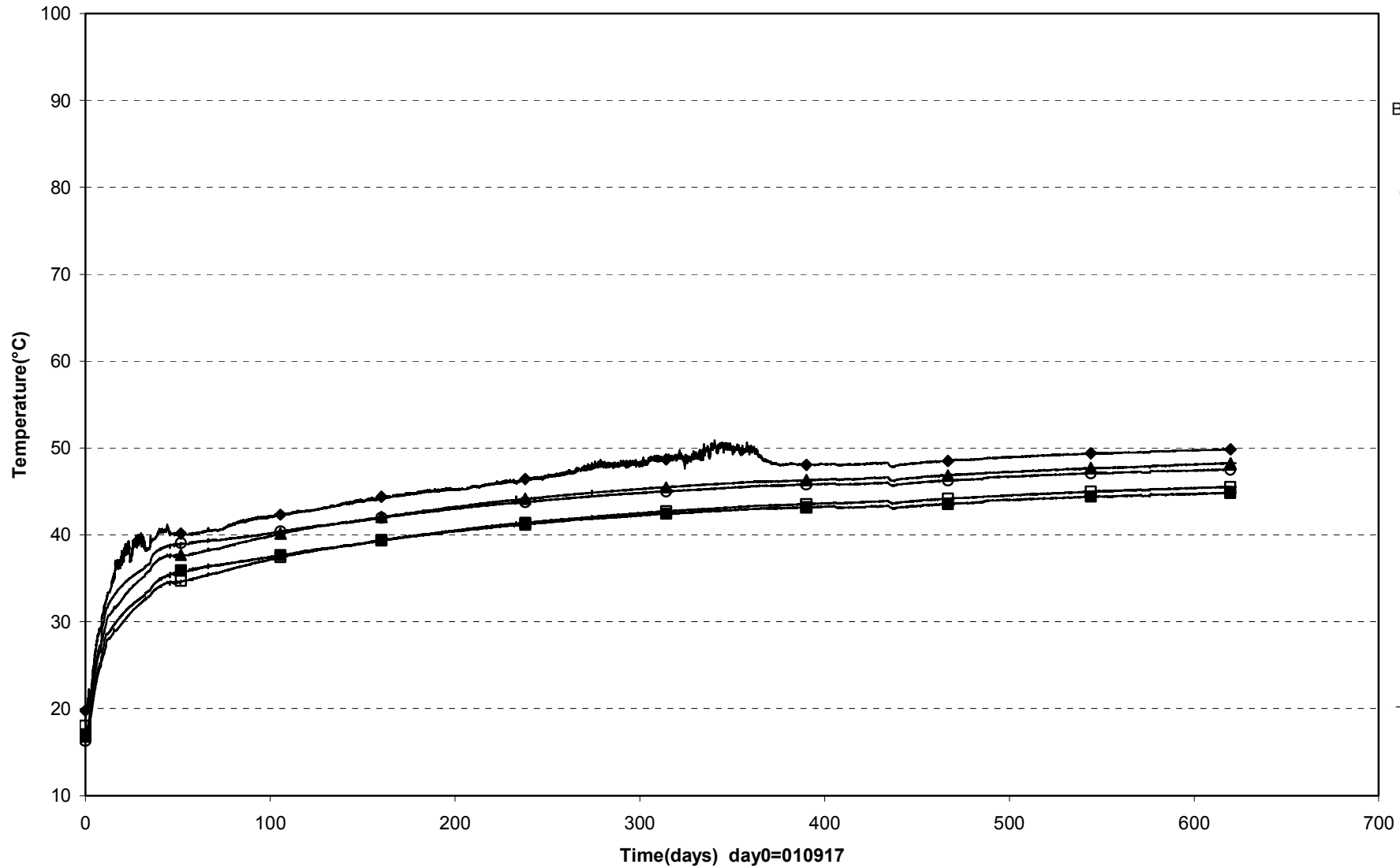

○ TBU10024(5.508\0°\0.635) ■ TBU10025(5508\0°\735) ◆ TBU10026(5508\270°\585) ▲ TBU10027(5.508\270°\0.685) □ TBU10028(5.508\270°\0.785)

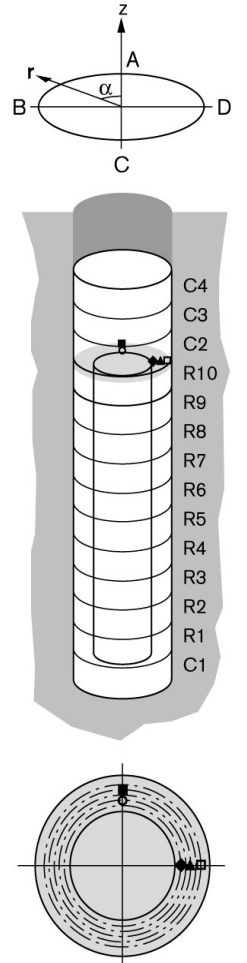

Prototype\Hole 1 \Cyl.3 and Cyl.4 (010917-030601)
 Temperature - Pentronic

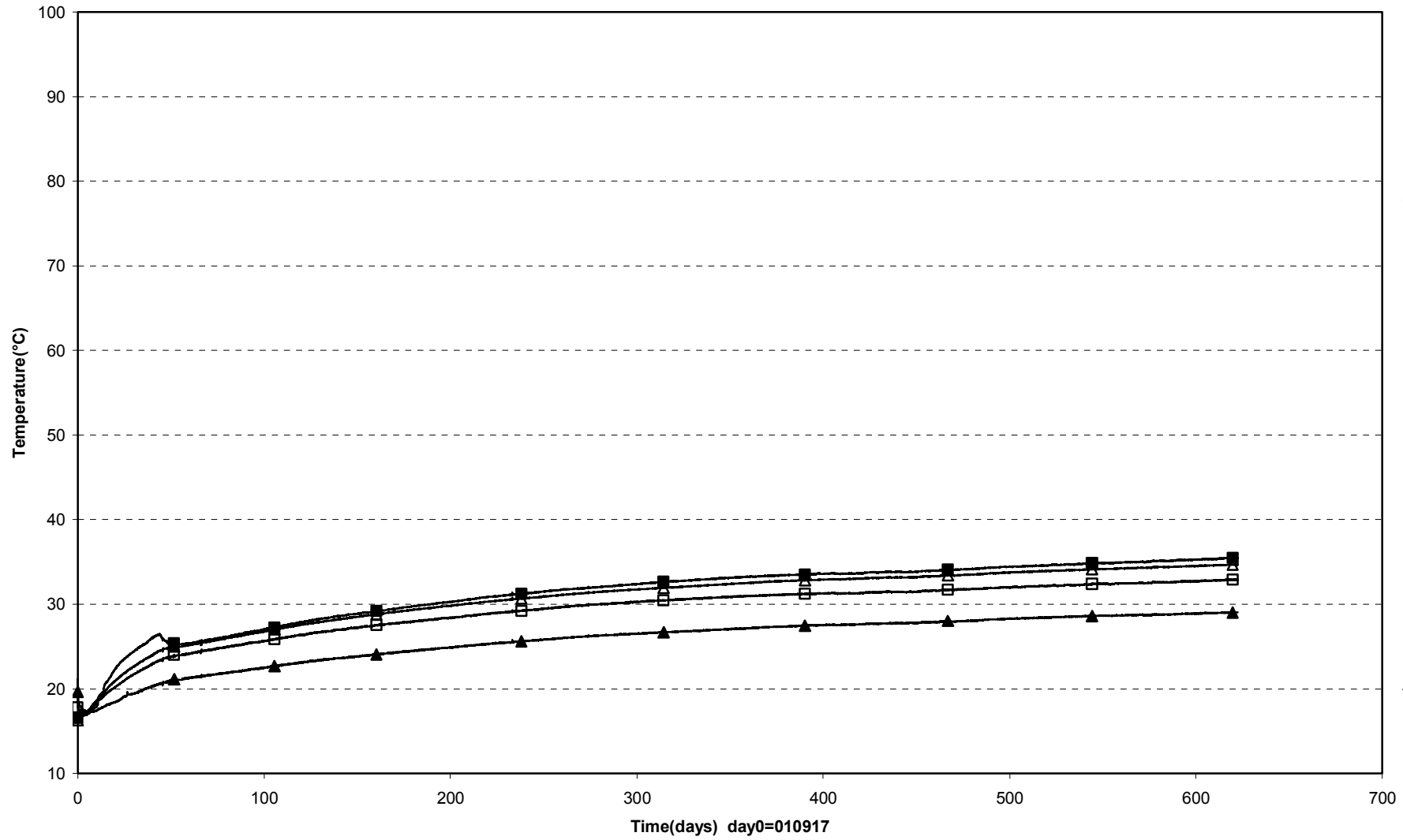

□ TBU10029(6.317\0°\0.785) △ TBU10030(6.317\95°\0.585) ■ TBU10031(6.317\185°\0.585) ▲ TBU10032(7.026\0°\0.785)

Prototype\Rock\Hole 1 (010917-030601)
 Temperature - Pentronic

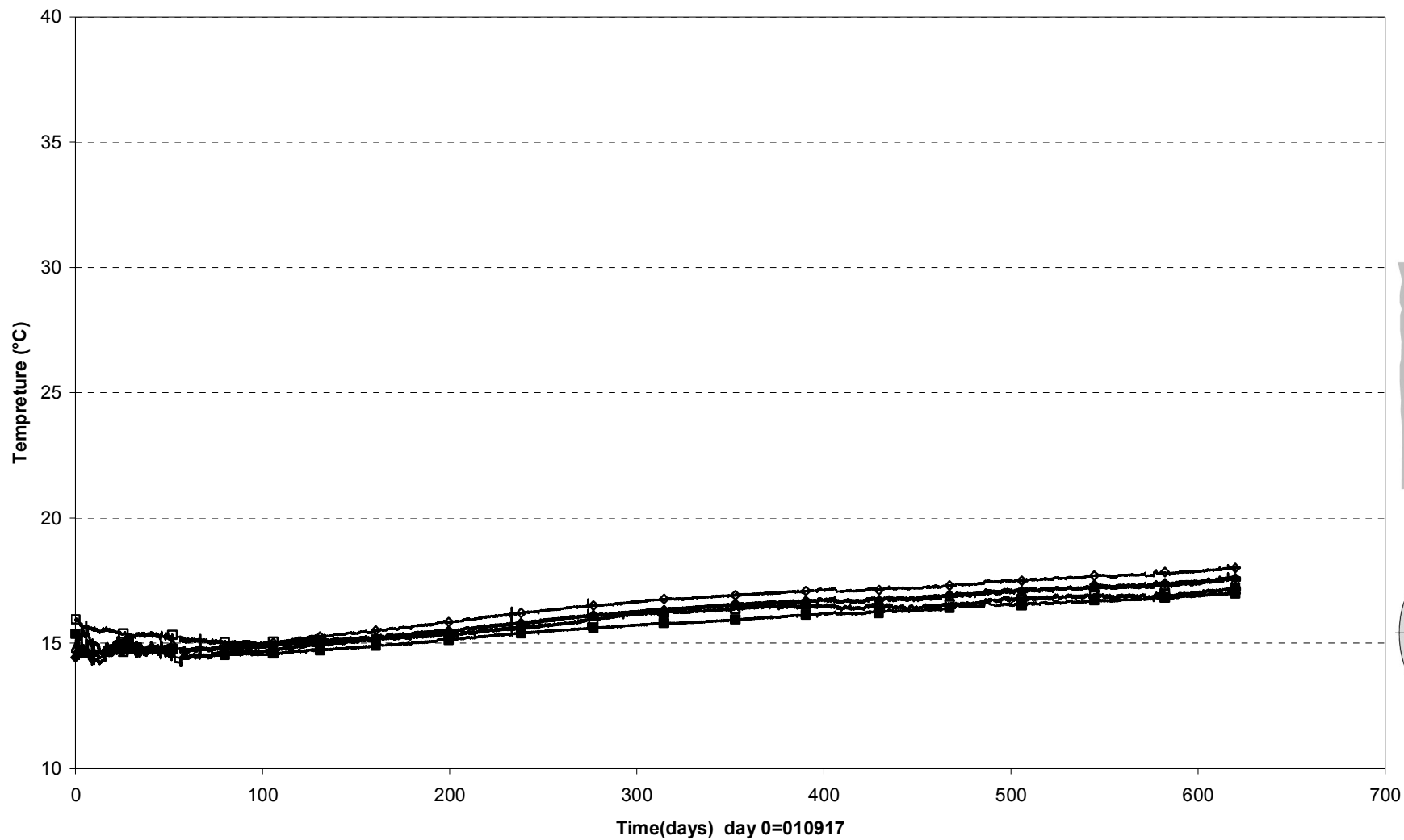

□ TROA350 (7.784\360°\9.086) △ TROA340 (5.784\360°\9.086) ◇ TROA330(3.384\0°\9.086) ◆ TROA320(9.85\0°\9.087) ■ TROA310(-1.715\0°\9.086)

Prototype\Rock\Hole 1 (010917-030601)
 Temperature - Pentronic

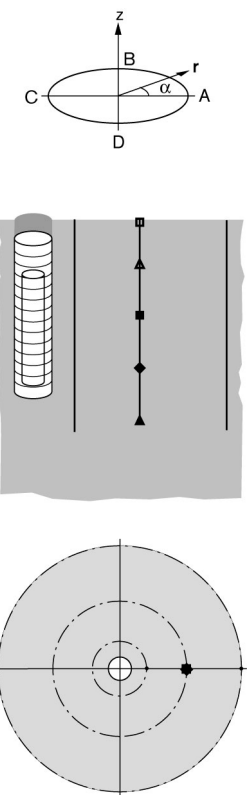
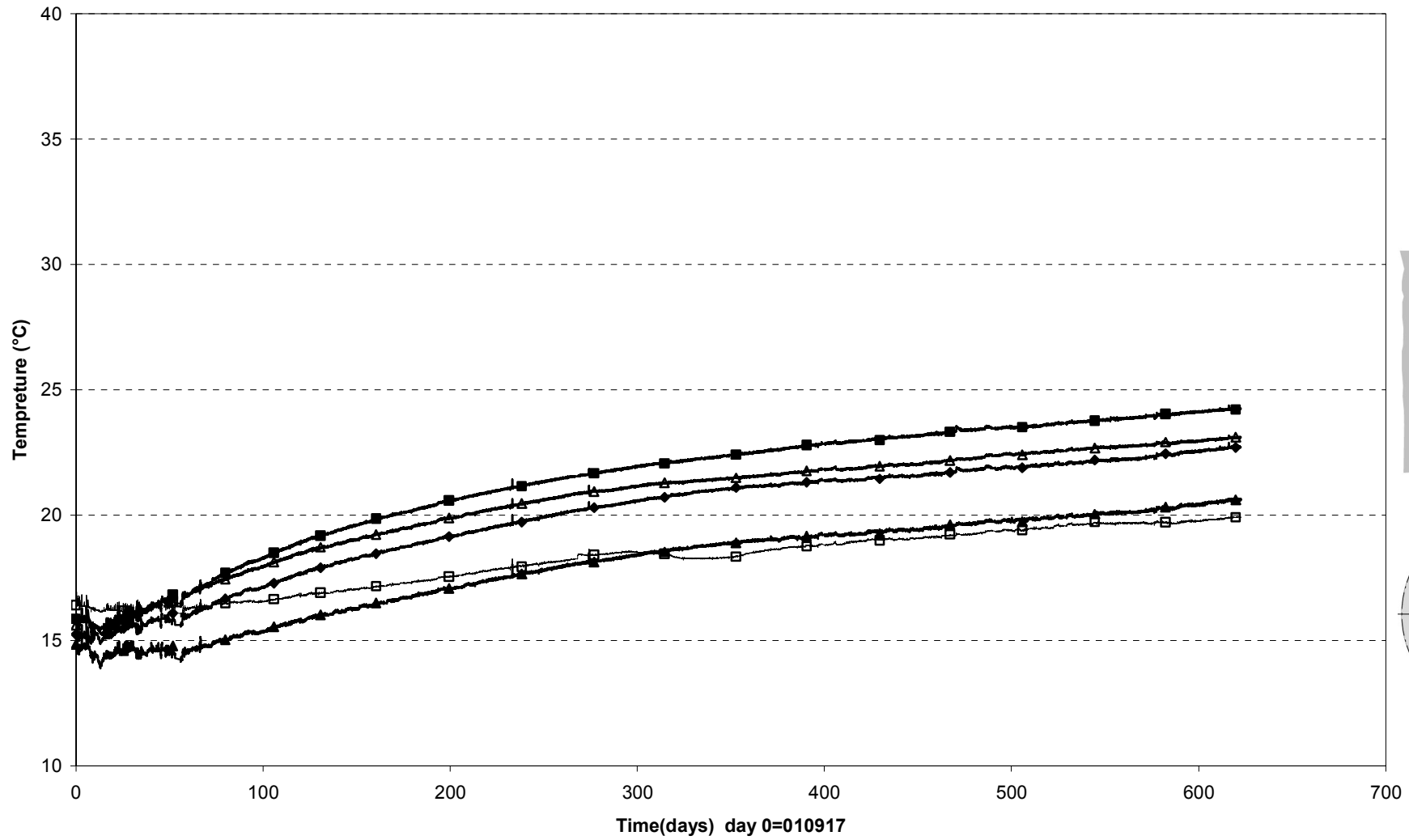

□ TROA650(7.921\360°\4.966) △ TROA640(5.921\360°\4.988) ■ TROA630(3.521\360°\4.978) ◆ TROA620(1.121\360°\4.968) ▲ TROA610(-1.479\360°\4.956)

Prototype\Rock\Hole 1 (010917-030601)
 Temperature - Pentronic

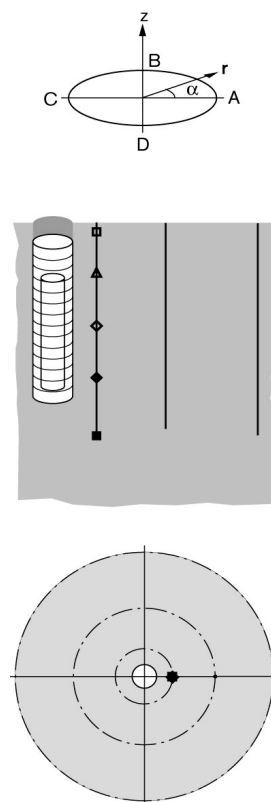
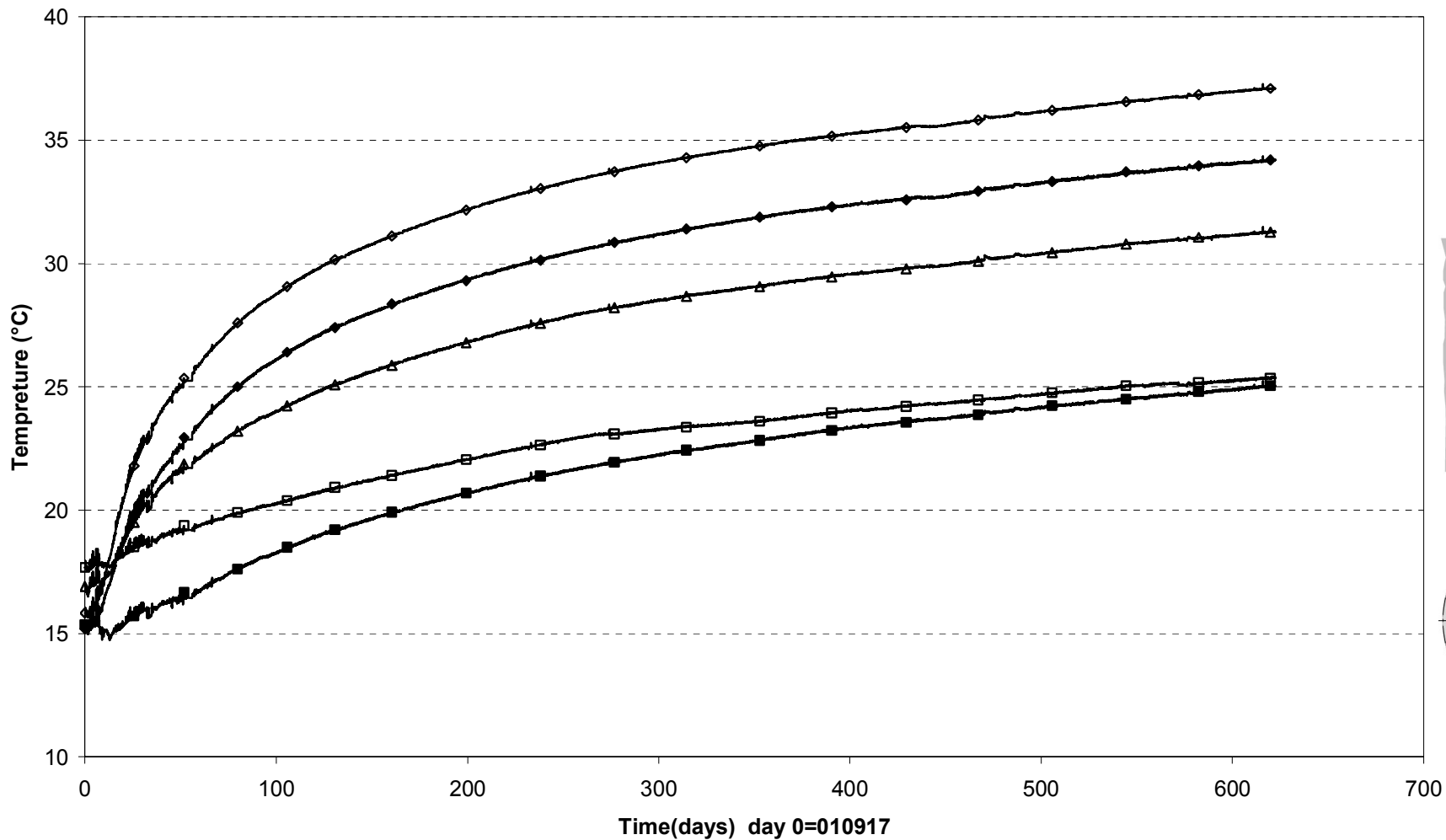

□ TROA1050(7.662\359°\2.020) △ TROA1040(5.662\359°\2.028) ◇ TROA1030(3.262\359°\2.038) ◆ TROA1020(0.862\359°\2.048) ■ TROA1010(-1.838\359°\2.059)

Prototype\ Hole 1 (010917-030601)
Canister power

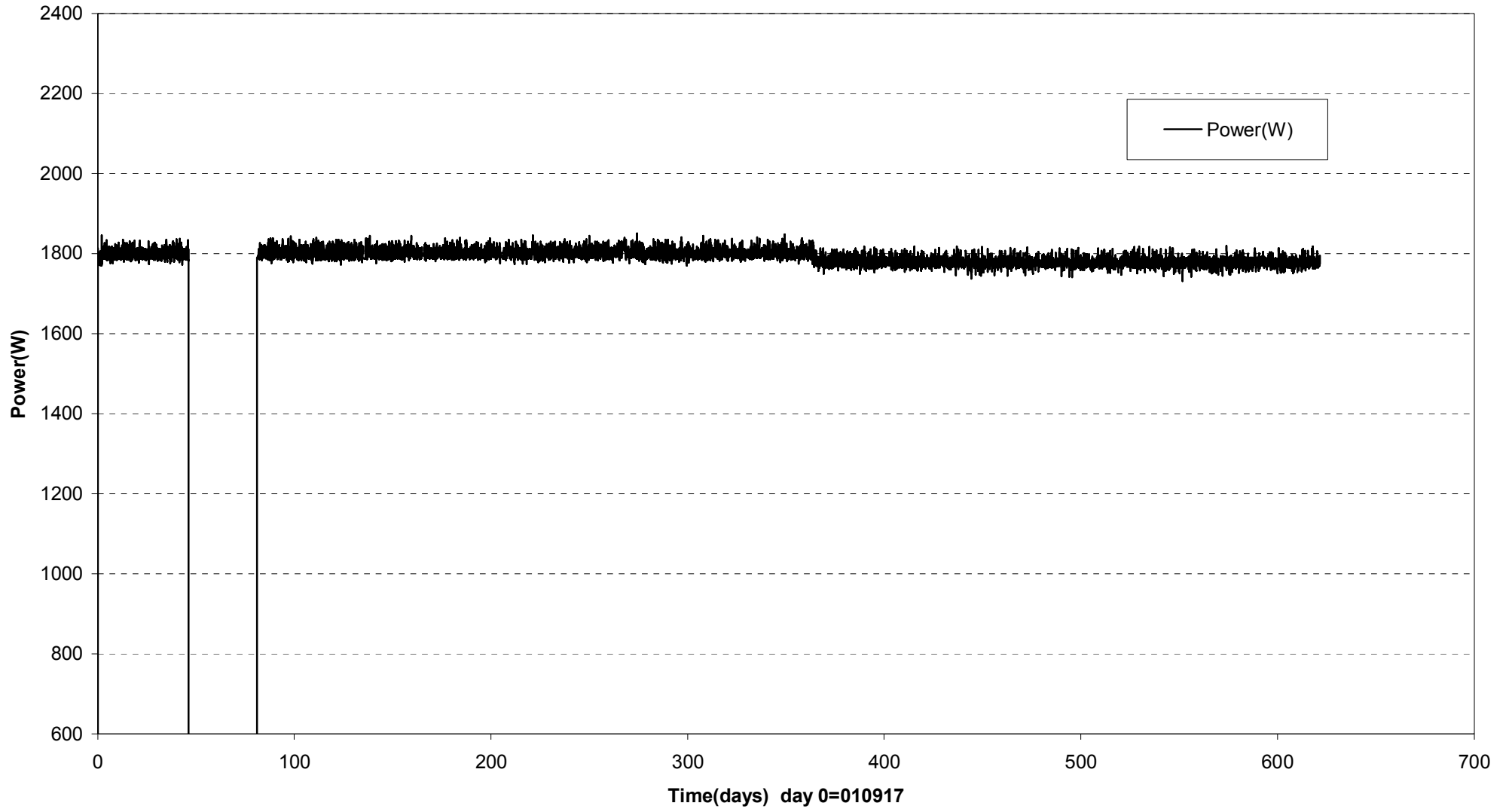

Prototype\ Hole 1 \Canister (010917-030601)
 Max. temperature on the canister surface - Optical fiber cables

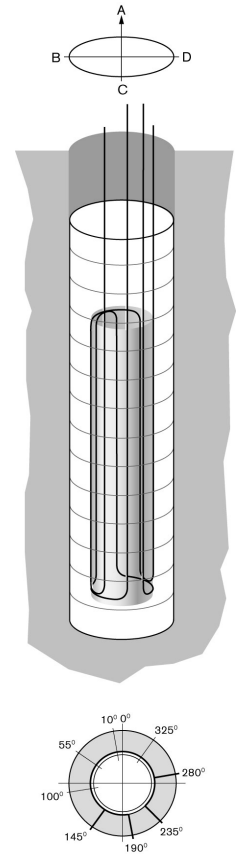
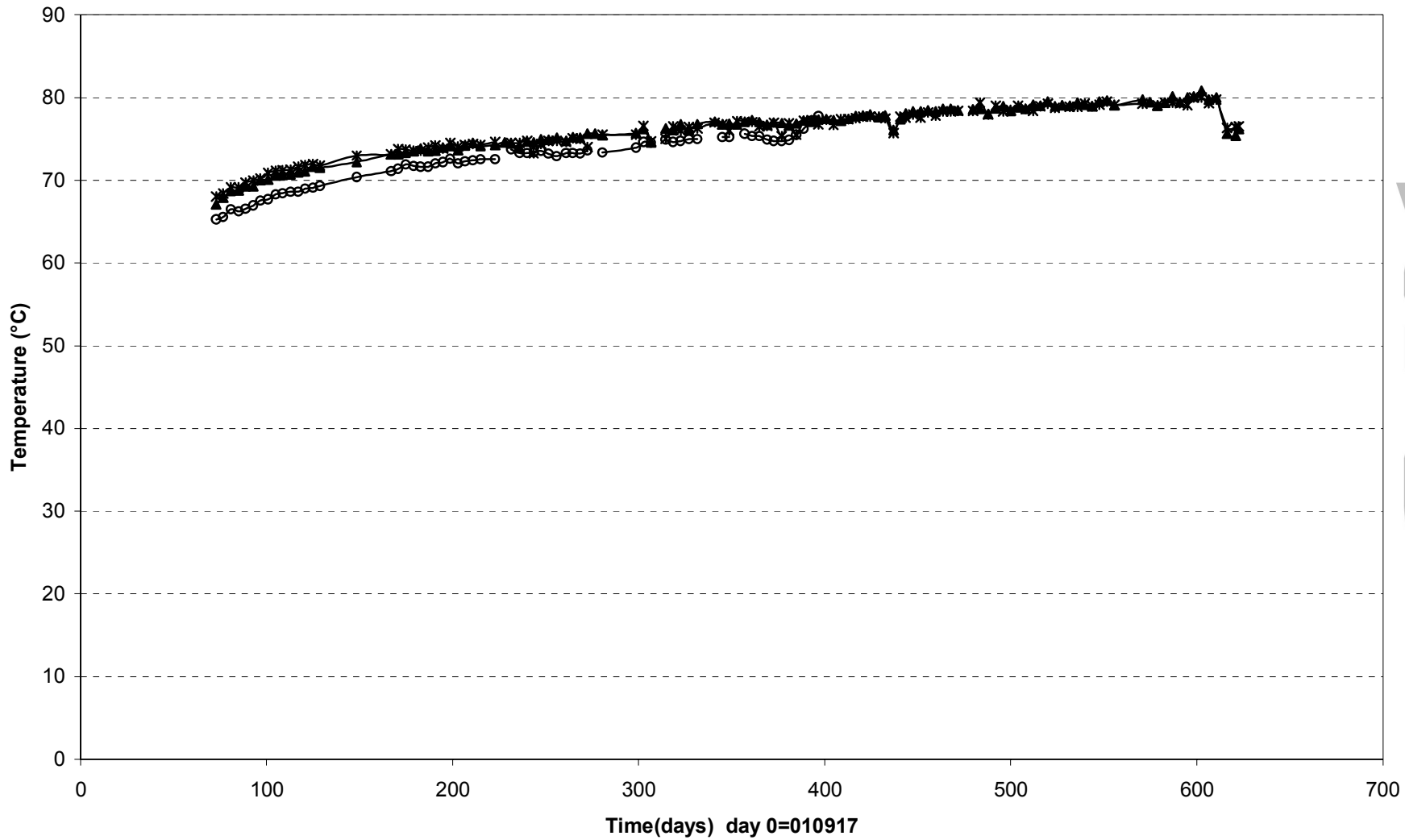

Prototype\ Hole 1 \ Canister (030601)
Temperature profile on the canister surface - Optical fiber cables

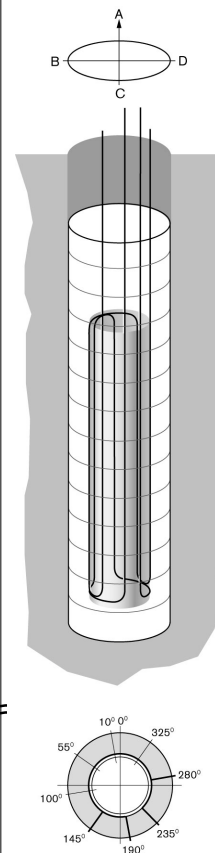
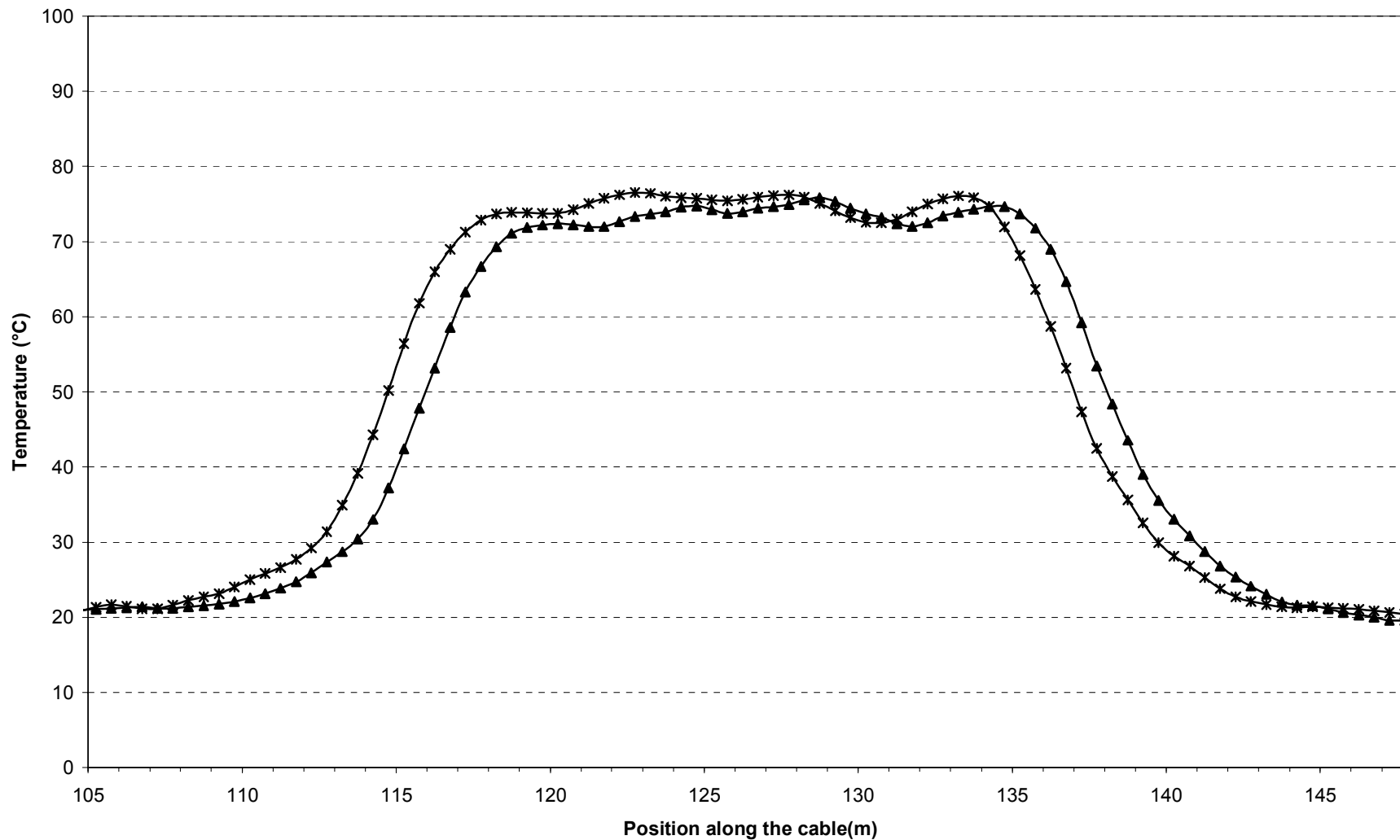

Appendix 2

Dep. hole 3

Prototype\Hole 3\Cyl.1 (010917-030601)
Total pressure - Geokon

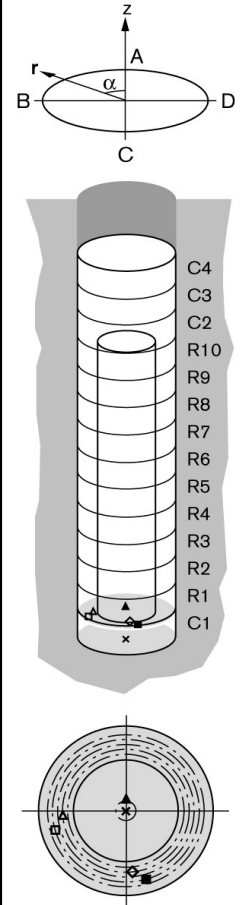
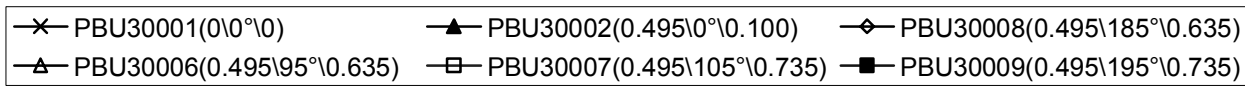
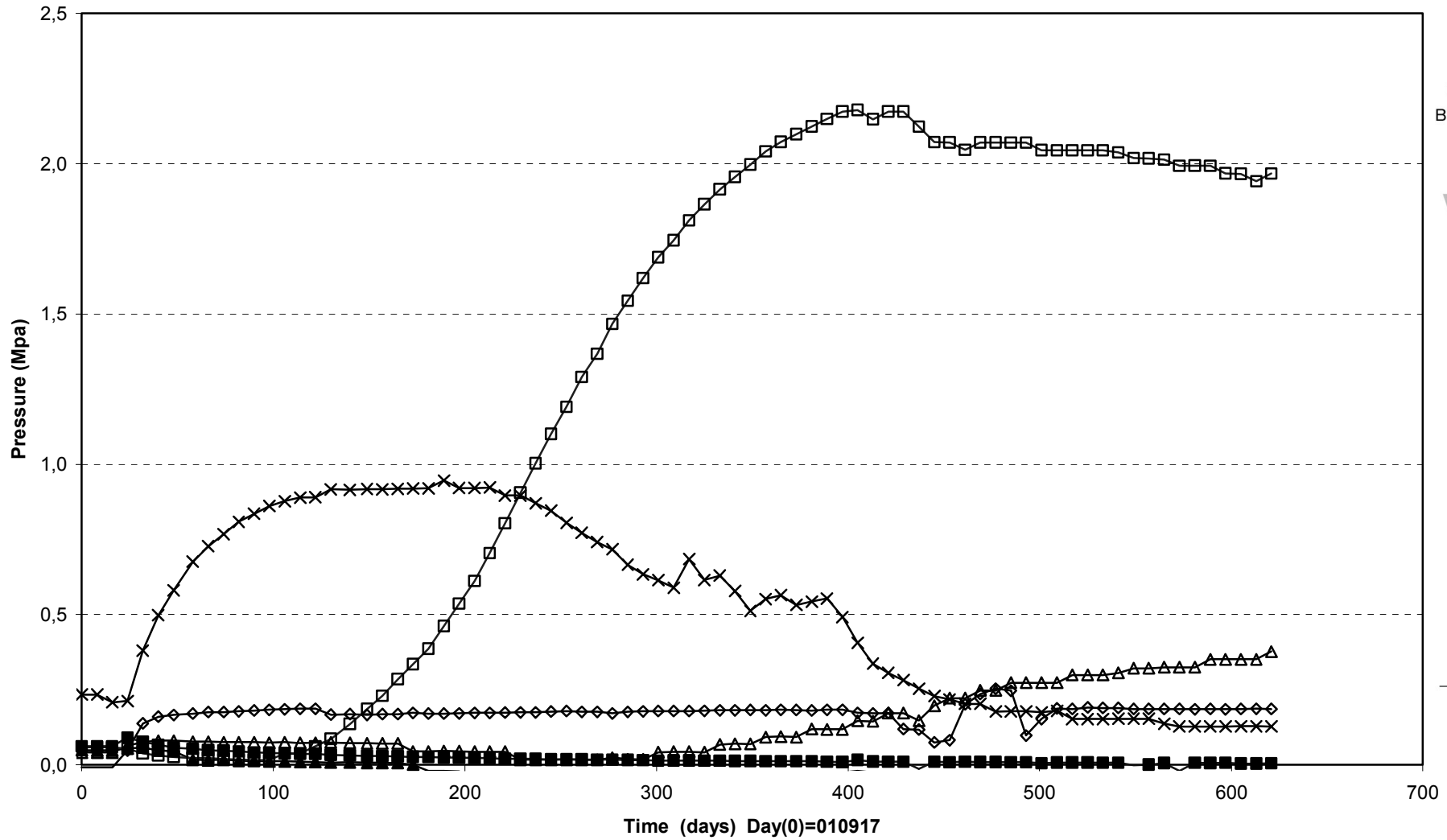

Prototype\Hole 3 \Ring5 (010917-030601)
 Total pressure - Geokon

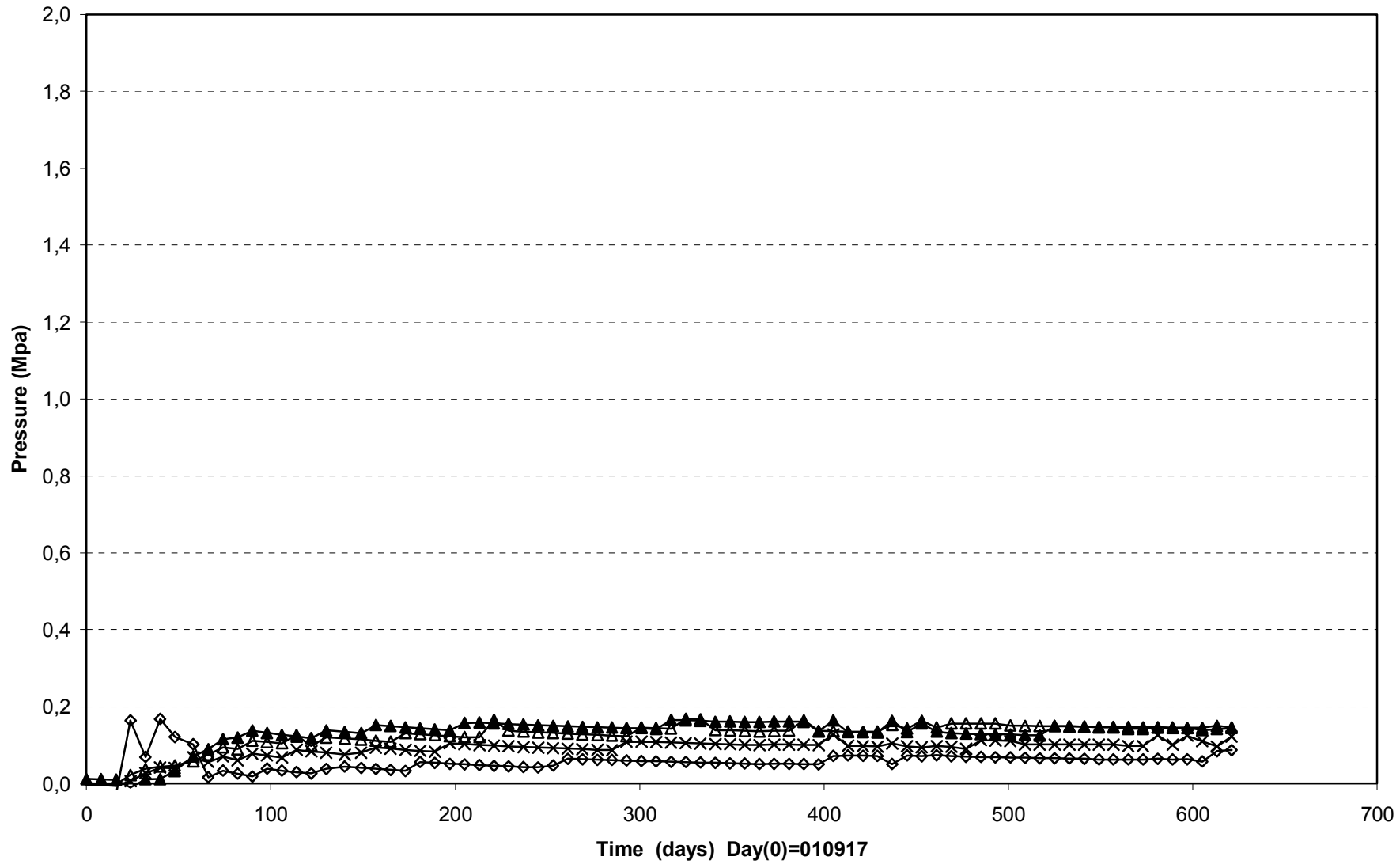

—x— PBU30013(2.771\95°\0.585)
 —▲— PBU30011(2.771\5°\0.685)
 —◇— PBU30014(2.771\95°\0.785)
 —△— PBU30015(3.021\185°\0.535)

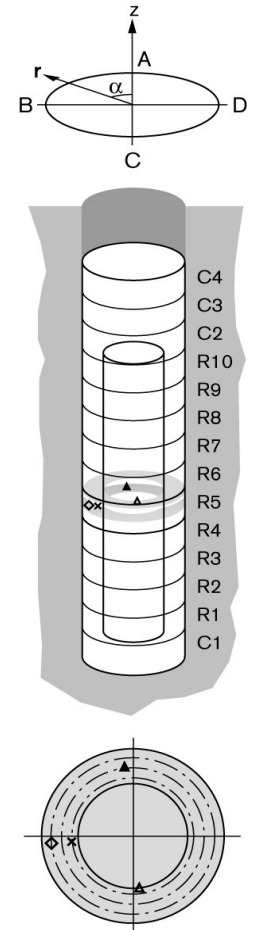

Prototype\Hole 3\Ring10 and Cyl.3 (010917-030601)
 Total pressure - Geokon

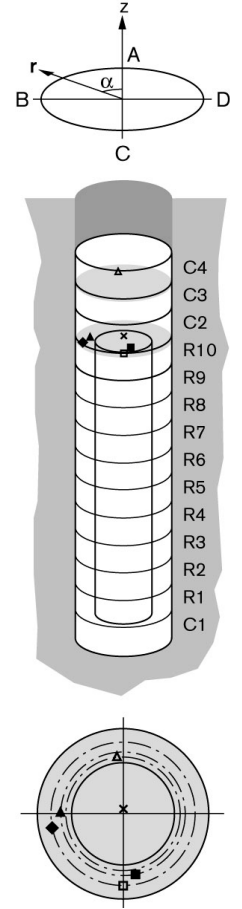
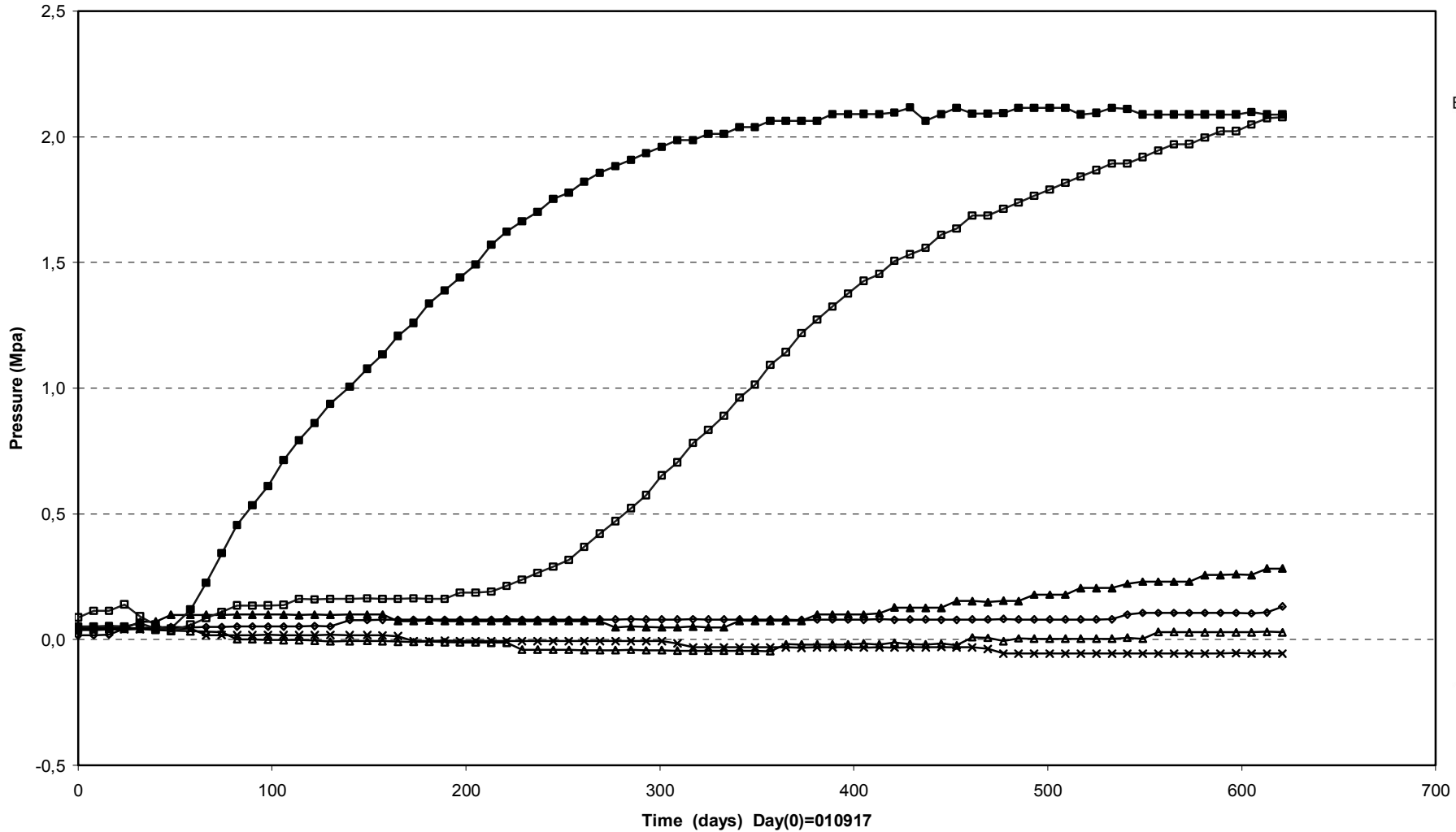

* PBU30017(5.556\0°\0.050) ▲ PBU30021(5.556\90°\0.635) ◆ PBU30022(5.556\100°\0.735)
 ▲ PBU30026(6.654\5°\0.585) □ PBU30023(5.556\190°\0.735) ■ PBU30024(5.556\190°\0.635)

Prototype\Hole 3 \Cyl.1 and Ring5 (010917-030601)
 Total pressure - Kulite

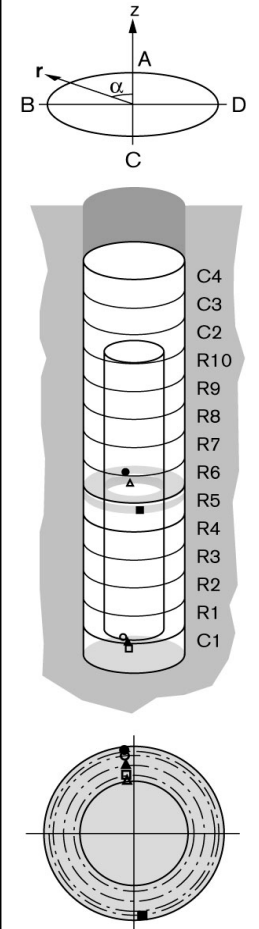
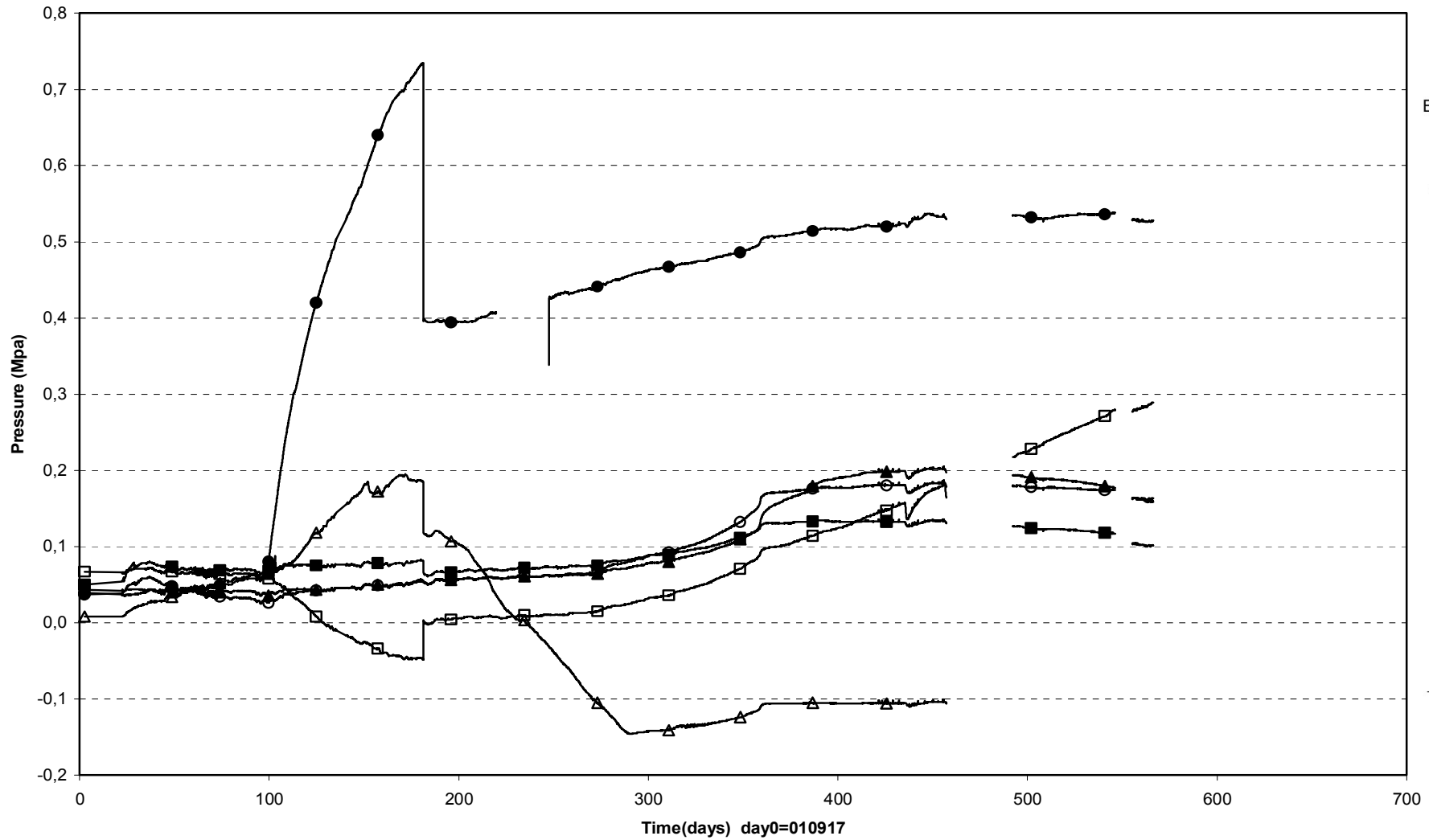

- | | | | |
|----------------------------|------------------------------|----------------------------|----------------------------|
| □ PBU30003(Cyl.1\5°\0.585) | ▲ PBU30004(Cyl.1\5°\0.685) | ○ PBU30005(Cyl.1\5°\0.785) | △ PBU30010(Ring5\5°\0.585) |
| ● PBU30012(Ring5\5°\0.825) | ■ PBU30016(Ring5\185°\0.825) | | |

Prototype\Hole 3\Ring10 and Cyl.3-4 (010917-030601)
 Total pressure - Kulite

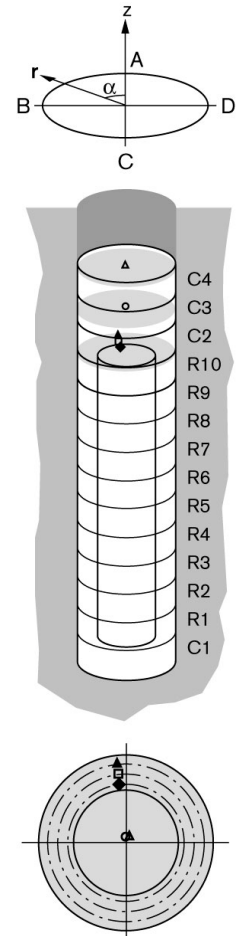
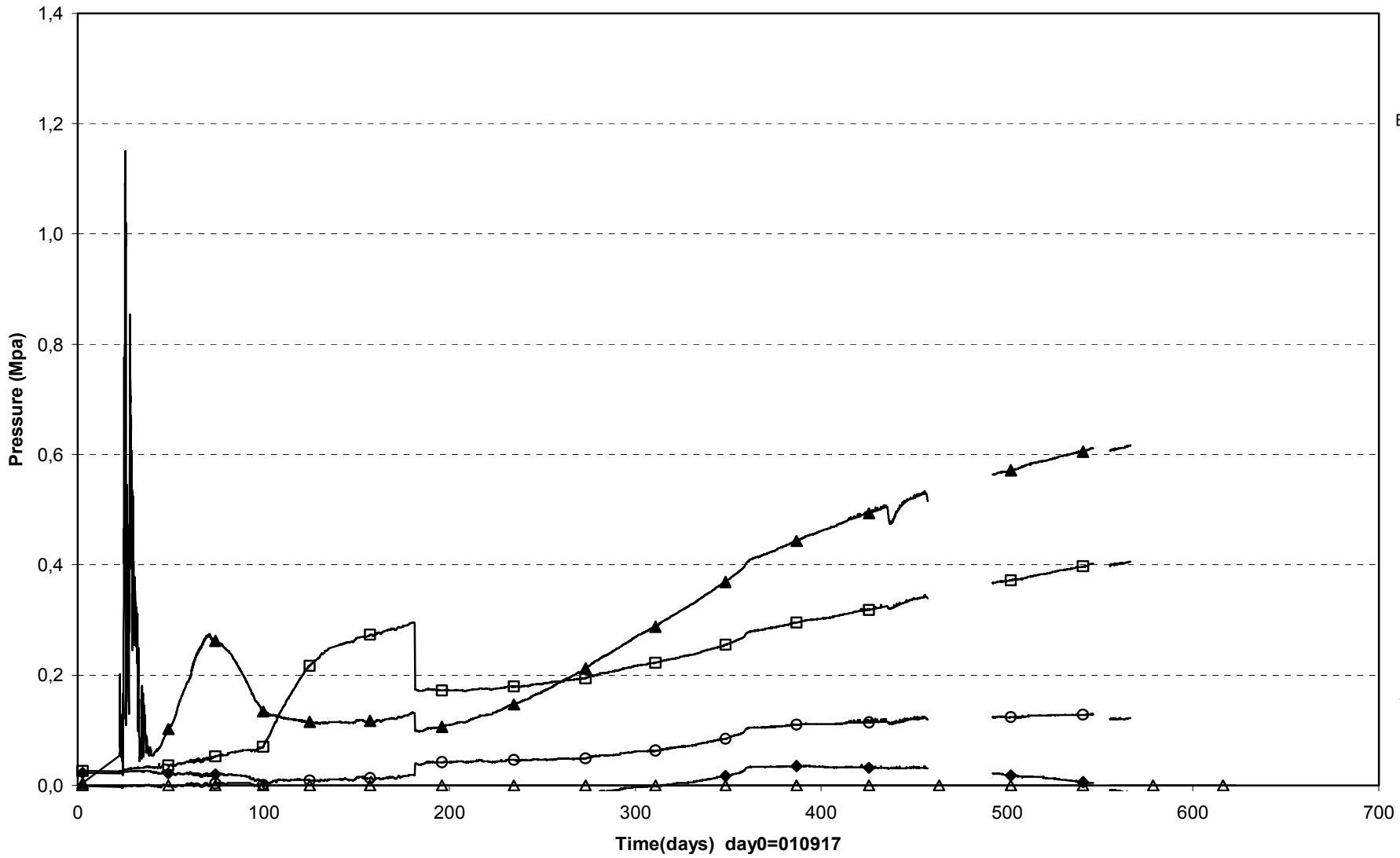

◆ PBU30018(Ring10\5°\0.585) □ PBU30019(Ring10\5°\0.685) ▲ PBU30020(Ring10\5°\0.785) ○ PBU30025(Cyl.3\10°\0.050) △ PBU30027(Cyl.4\10°\0.050)

Prototype\Hole 3\Cyl.1 (010917-030601)
Relative humidity - Vaisala

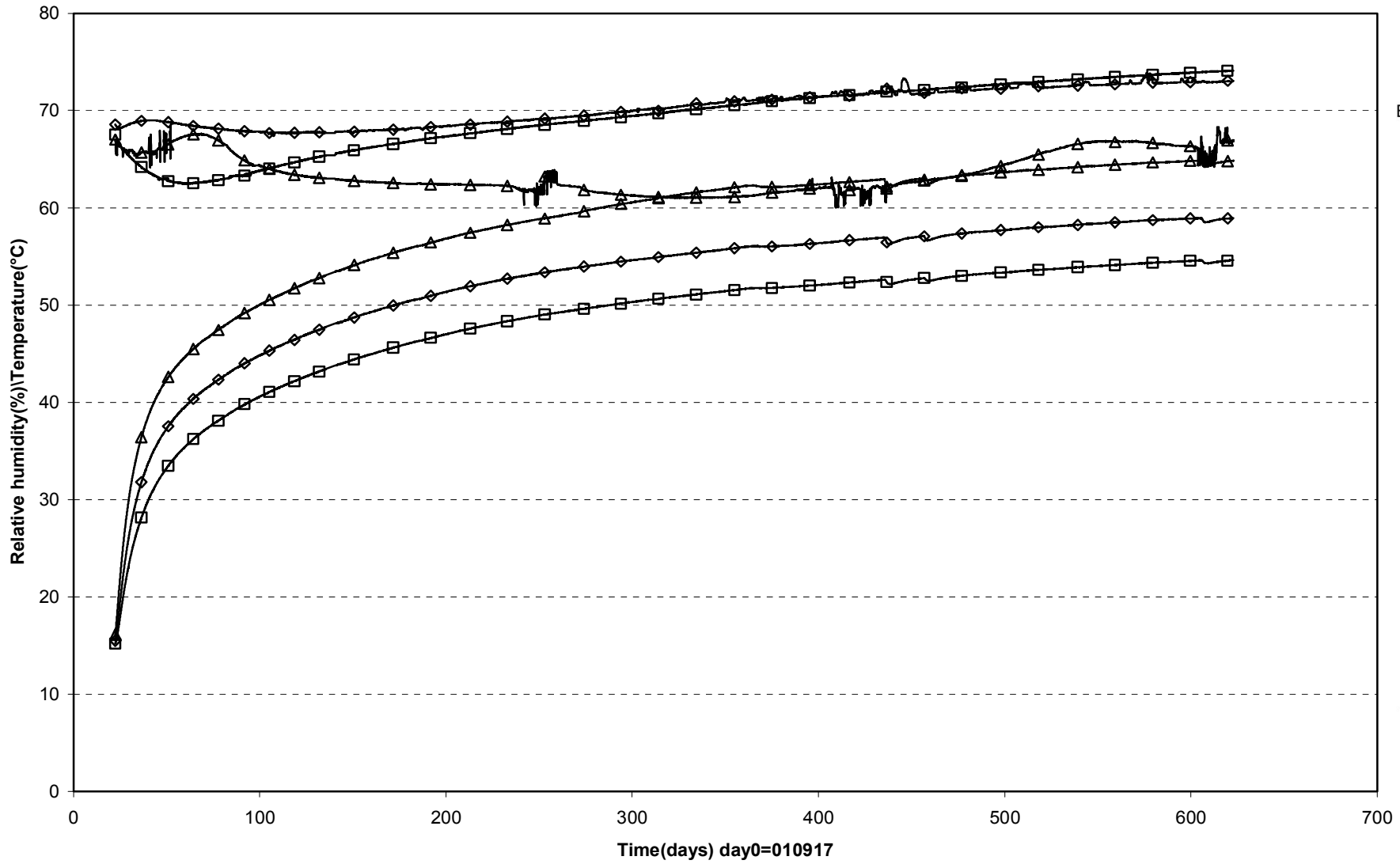

□ WBU30004(0.335\350°\0.785) ◇ WBU30005(0.335\350°\0.685) △ WBU30006(0.335\350°\0.585)

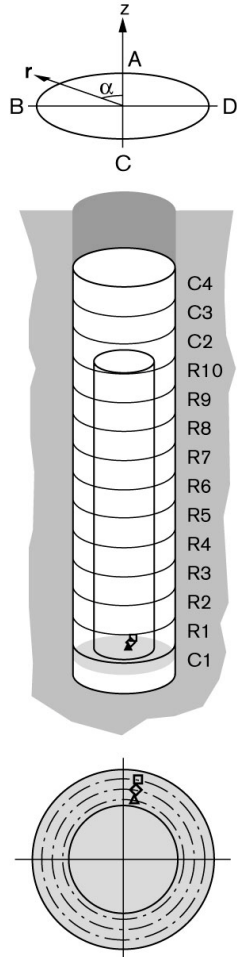

Prototype\Hole 3\Ring 5 (010917-030601)
Relative humidity - Vaisala

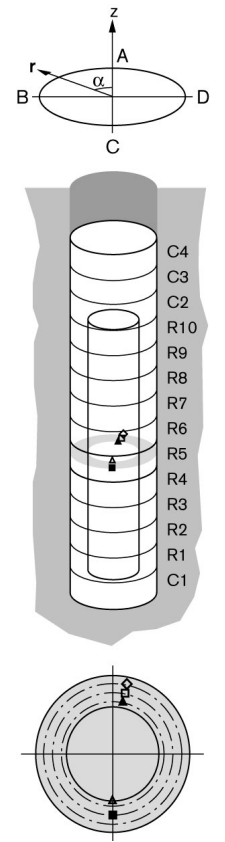
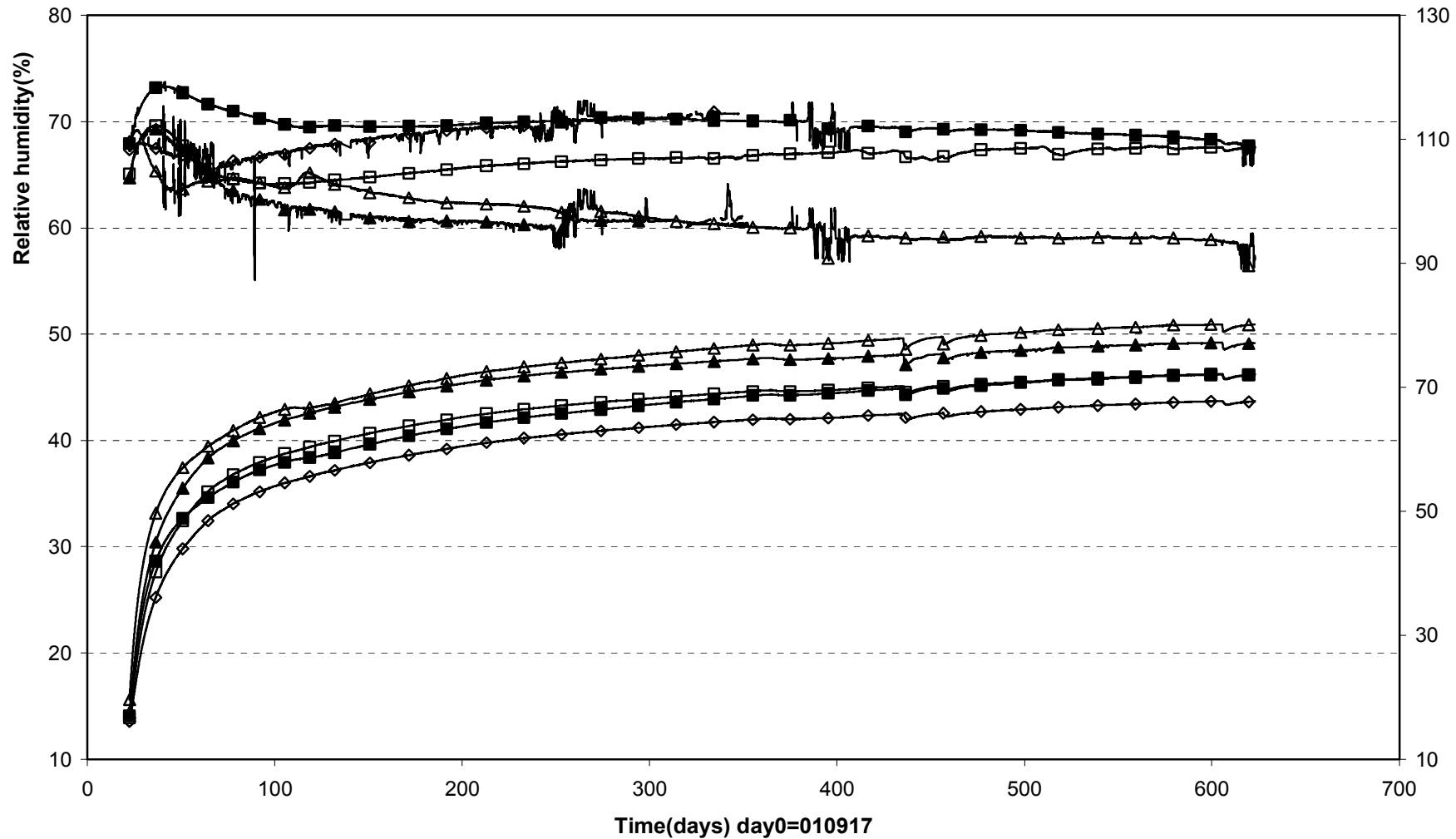

▲ WBU30013(2.840\350°\0.585)	□ WBU30014(2.840\350°\0.685)	◇ WBU30015(2.840\350°\0.785)
△ WBU30019(2.840\180°\0.535\In the slot)	■ WBU30020(2.840\180°\0.685)	

Prototype\Hole 3\Ring 10 (010917-030601)
Relative humidity - Vaisala

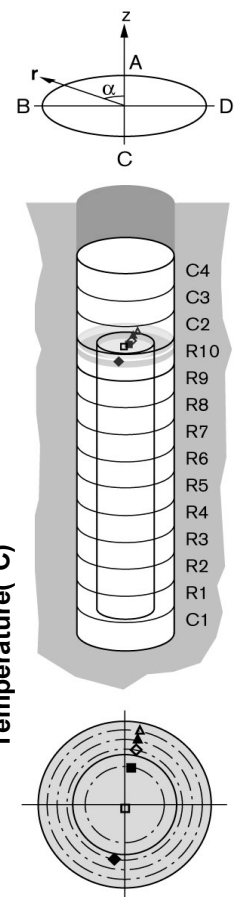
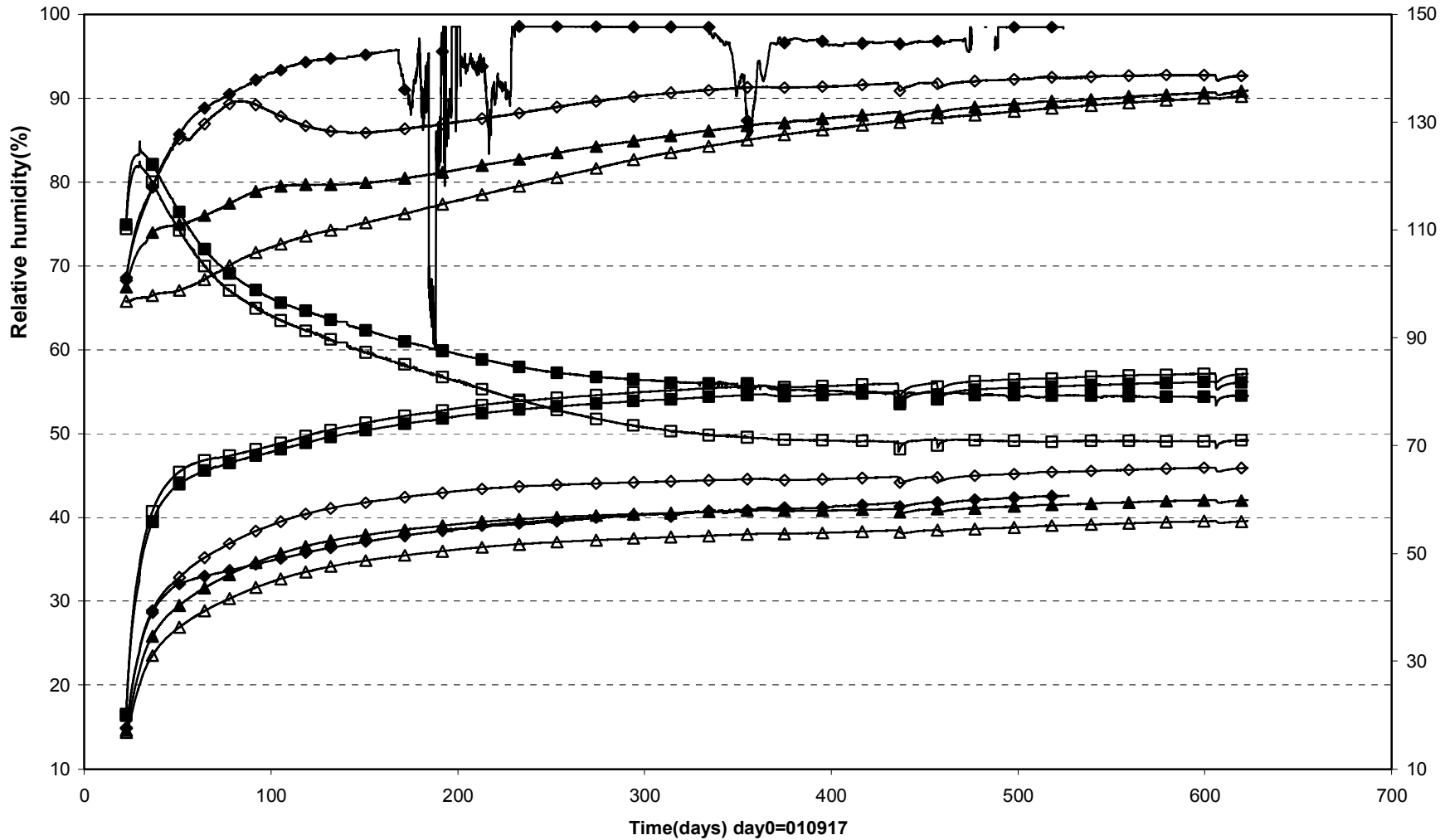

□ WBU30022(5.416\180°\0.050) ■ WBU30023(5.396\352°\0.262) ◇ WBU30024(5.396\350°\0.585) △ WBU30025(5.396\350°\0.785)
 ▲ WBU30026(5.396\350°\0.685) ◆ WBU30030(5.396\170°\0.585)

Prototype\Hole 3\Cyl.3 and Cyl.4 (010917-030601)
Relative humidity - Vaisala

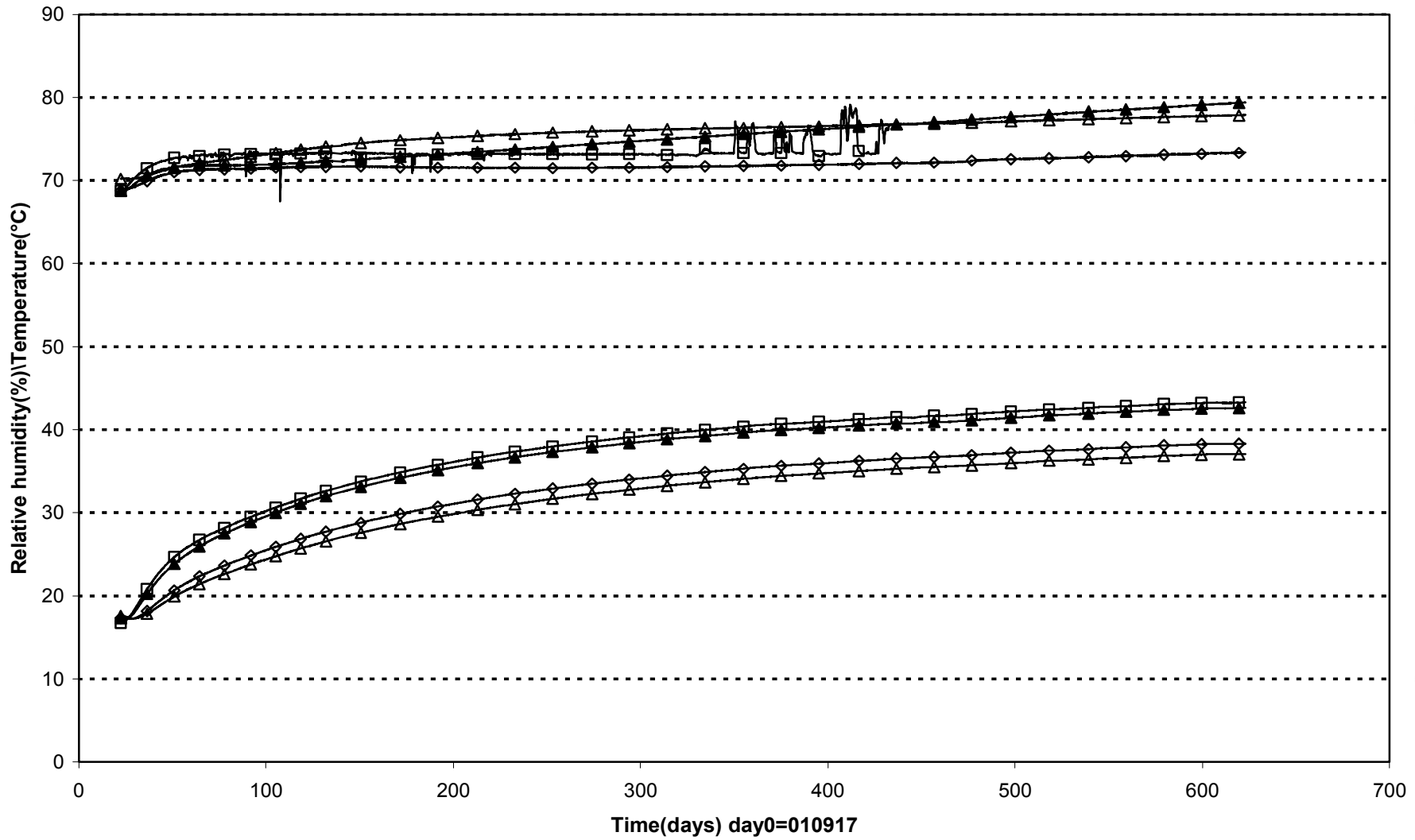

□ WBU30032(6.314\180°\0.050) ▲ WBU30033(6.314\350°\0.585) △ WBU30036(6.680\180°\0.050) ◇ WBU30037(6.840\270°\0.050)

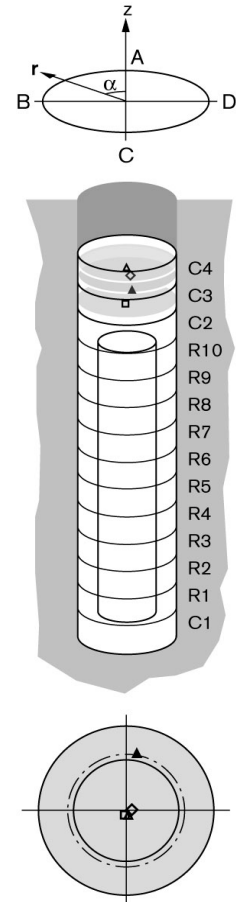

Prototype\Hole 3\Cyl.1 (010917-030601)
Relative humidity - Rotronic

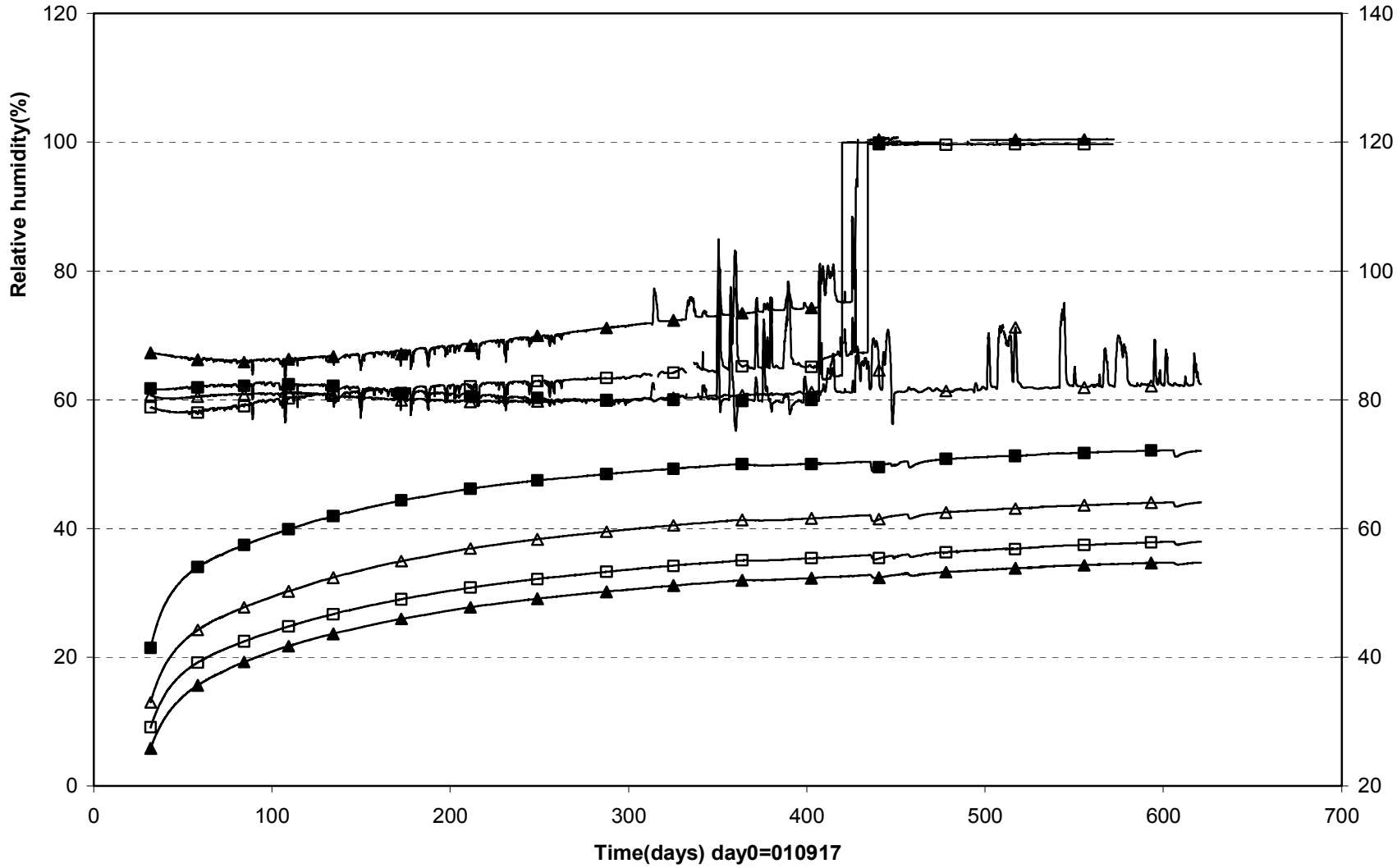

□ WBU30001(0.045\180°\0.050) △ WBU30002(0.215\0°\0.400) ■ WBU30003(0.245\180°\0.100) ▲ WBU30008(0.245\80°\0.685)

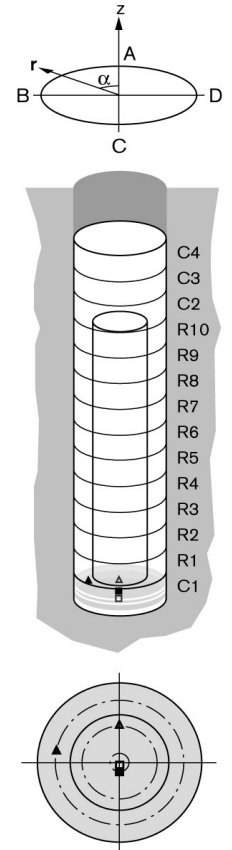

Prototype\Hole 3\Cyl.1 (010917-030601)
Relative humidity - Rotronic

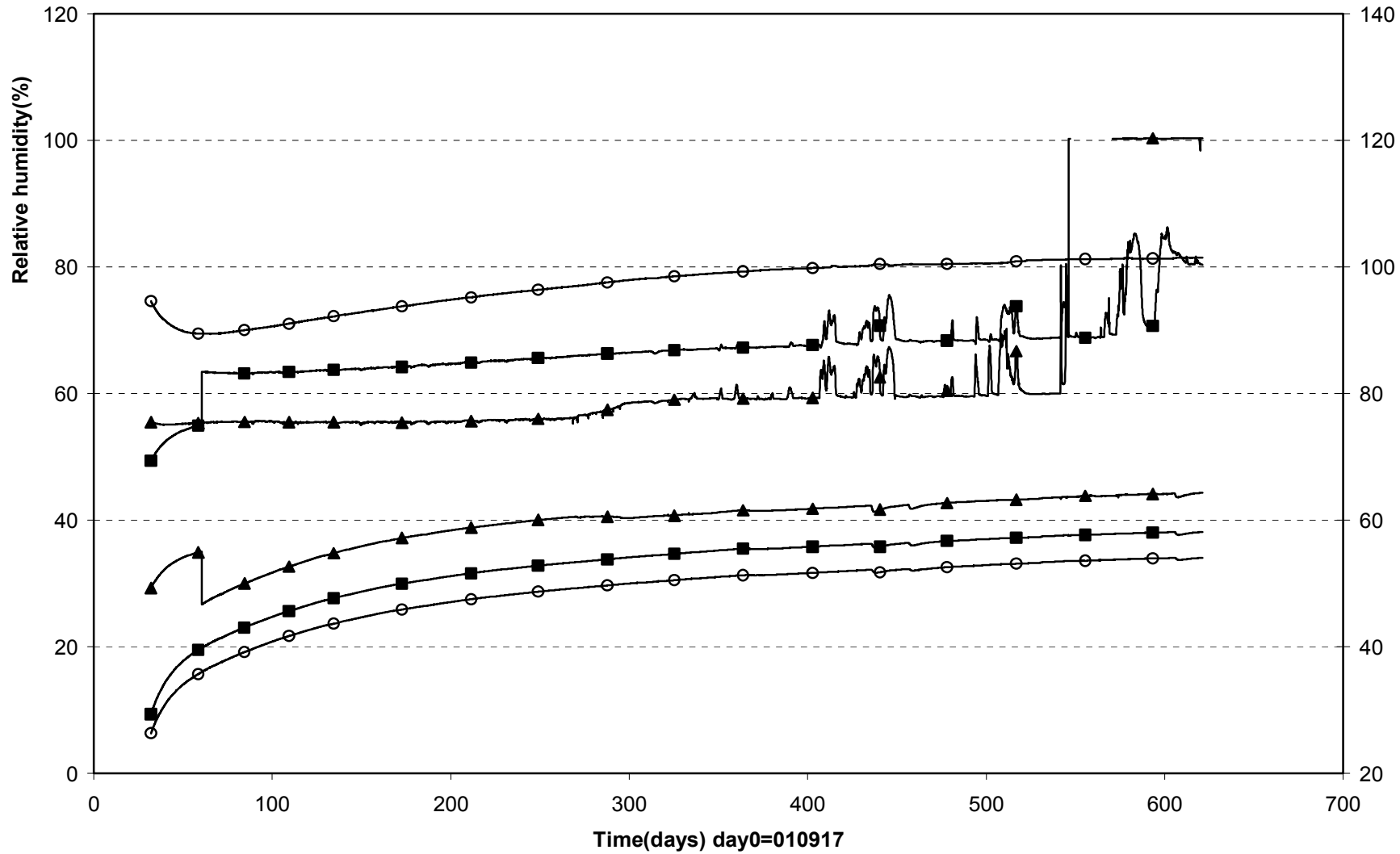

▲ WBU30010(0.245\170°\0.585) ■ WBU30011(0.245\170°\0.685) ○ WBU30012(0.245\170°\0.785)

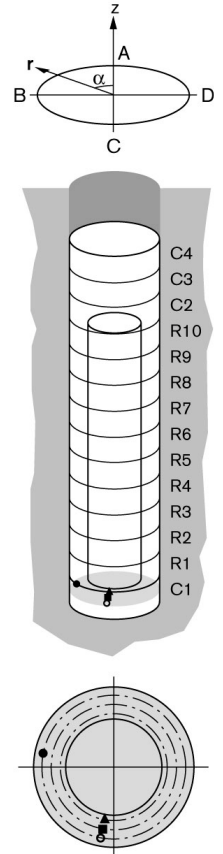

Prototype\Hole 3\Ring 5 (010917-030601)
Relative humidity - Rotronic

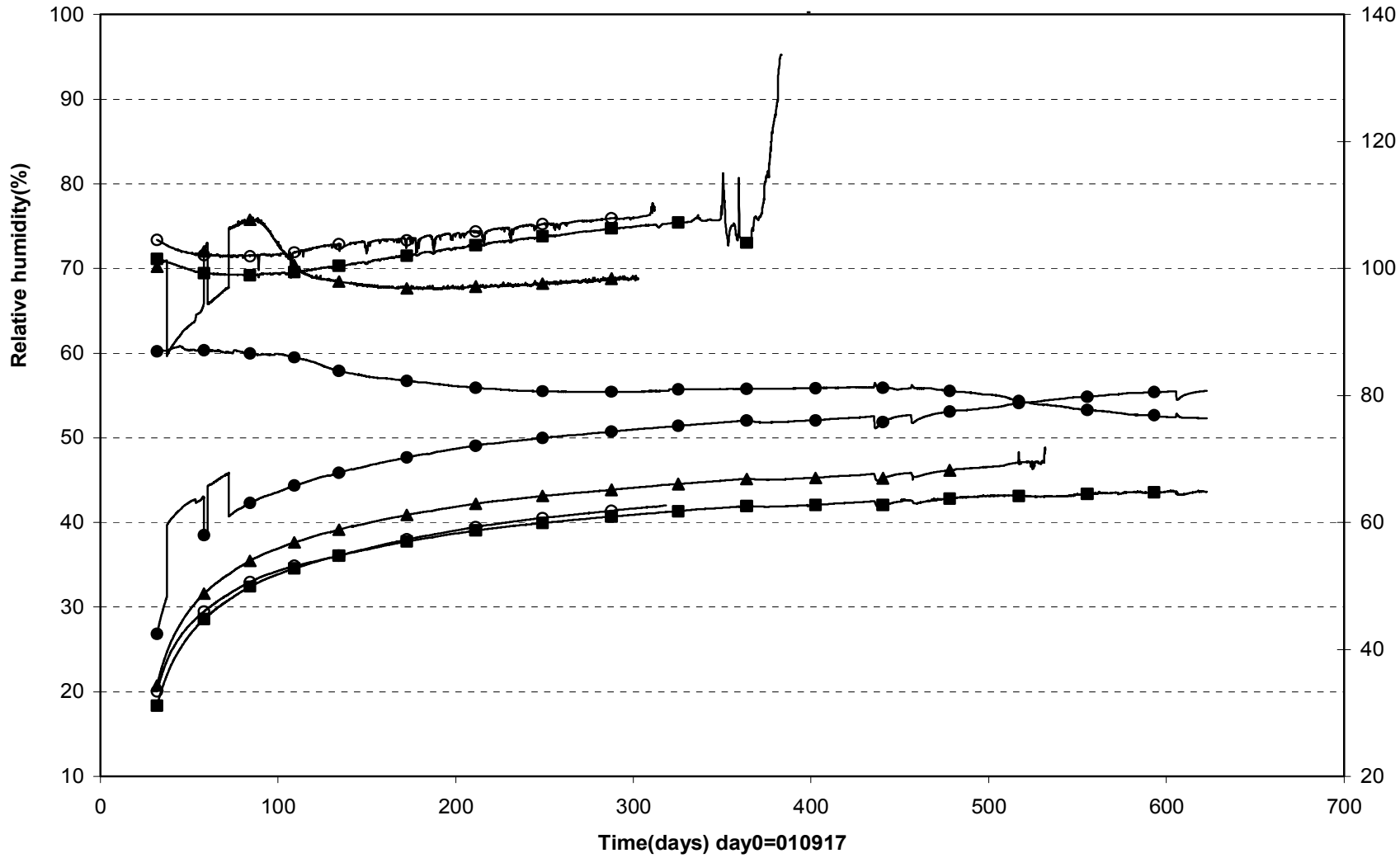

● WBU30016(2.750\80°\0.535) ▲ WBU30017(2.750\80°\0.685) ■ WBU30018(2.750\80°\0.785) ○ WBU30021(2.750\180°\0.785)

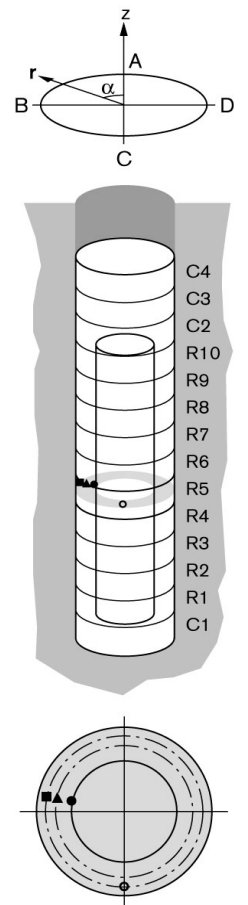

Prototype\Hole 3\Ring 10 (010917-030601)
Relative humidity - Rotronic

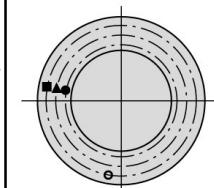
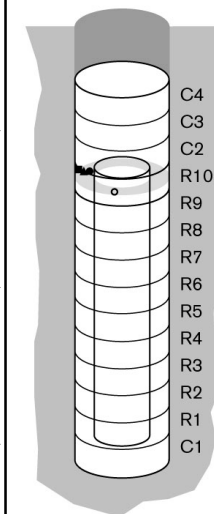
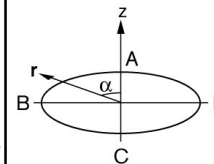
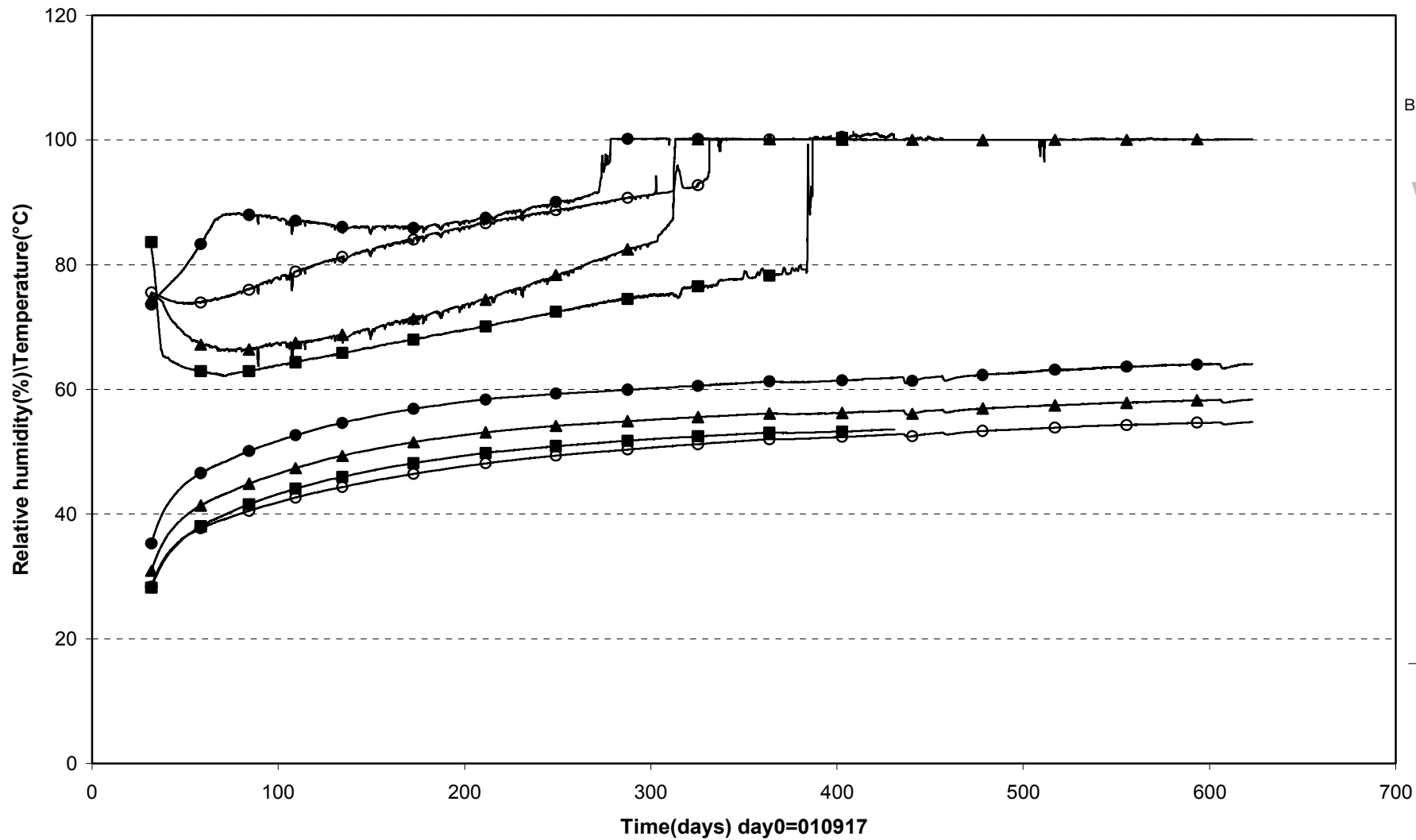

● WBU30027(5.306\80°\0.585) ▲ WBU30028(5.306\80°\0.685) ■ WBU30029(5.306\80°\0.785) ○ WBU30031(5.306\170°\0.785)

Prototype\Hole 3\Cyl.3 (010917-030601)
Relative humidity - Rotronic

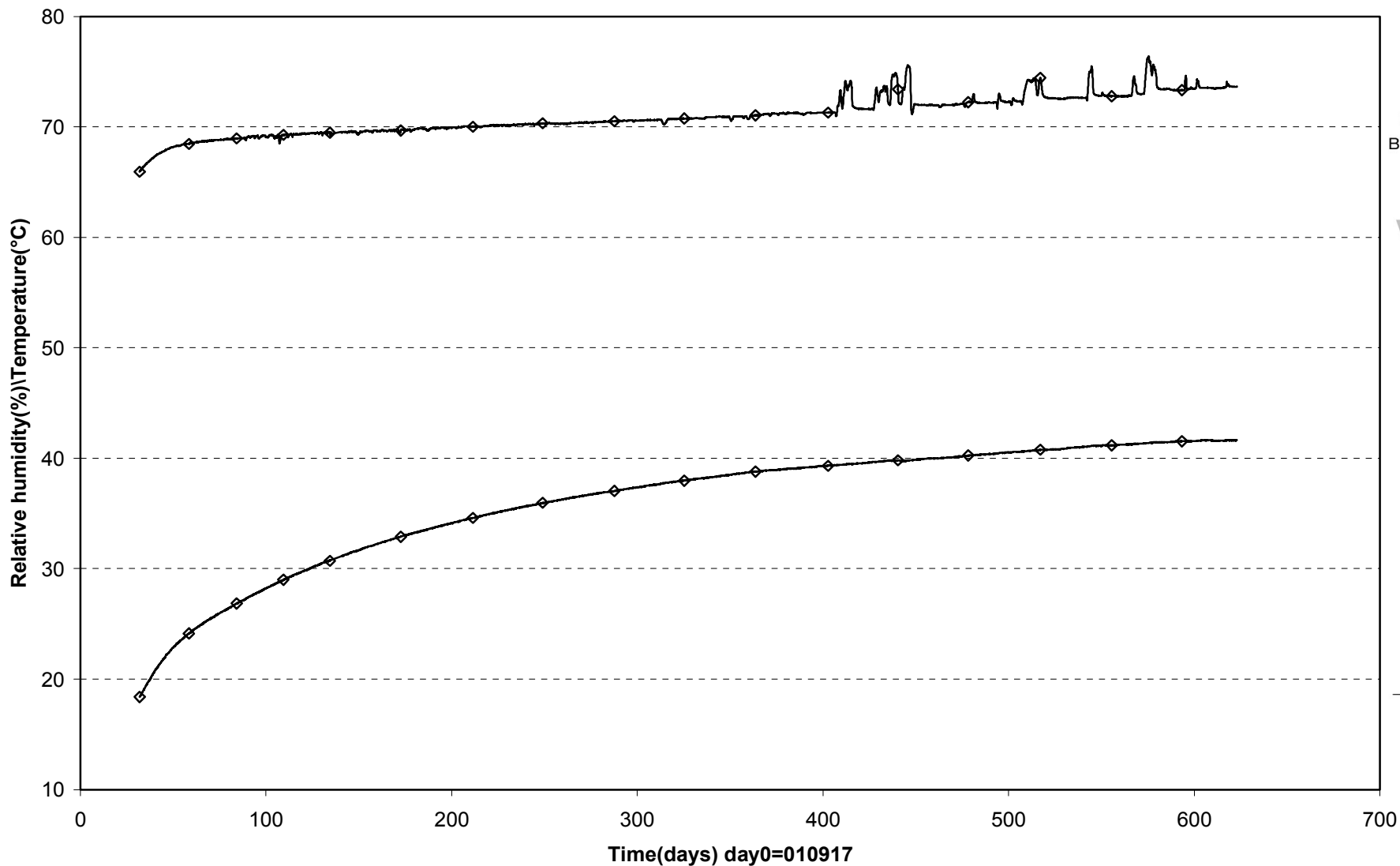

◇ WBU30035(6.314\180°\0.585)

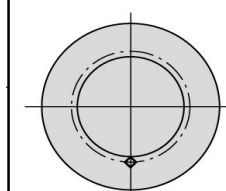
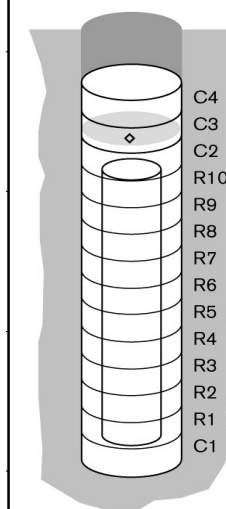
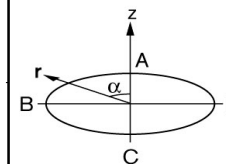

Prototype\Hole 3 (010917-030601)
Pore pressure - Geokon

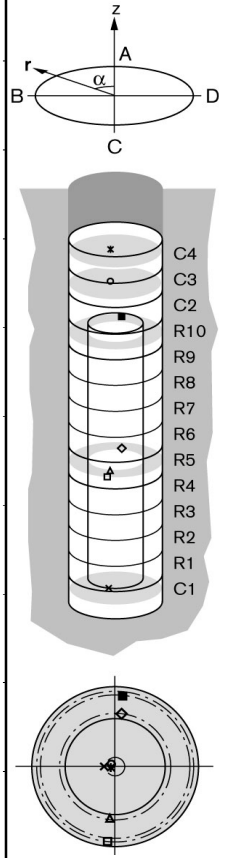
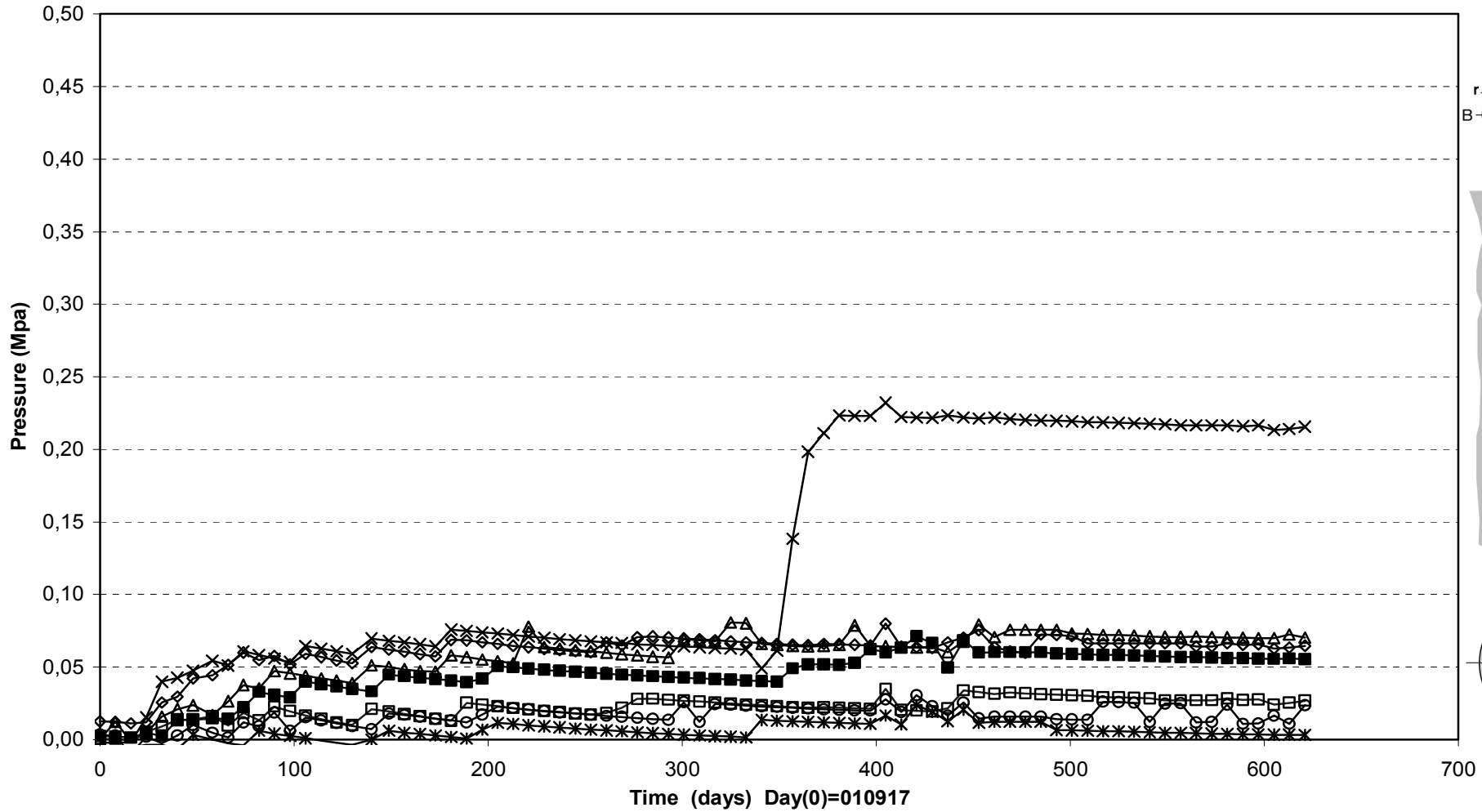

—x— UBU30002(0.245\90°\0.100)	—◇— UBU30005(2.771\355°\0.585)	—△— UBU30009(2.771\175°\0.535\in the slot)
—□— UBU30010(2.771\175°\0.825\in the slot)	—■— UBU30012(5.306\355°\0.785)	—○— UBU30013(6.314\90°\0.050)
—*— UBU30014(6.910\90°\0.050)		

Prototype\Hole 3 (010917-030601)
Pore pressure - Kulite

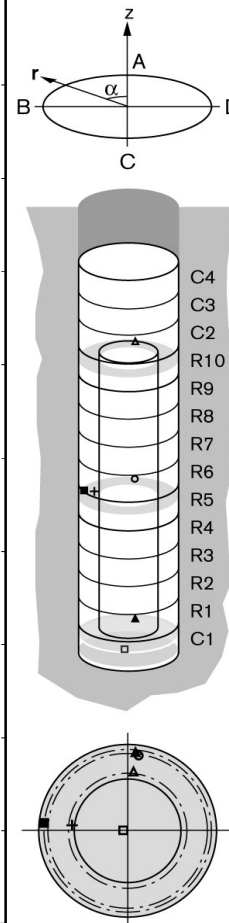
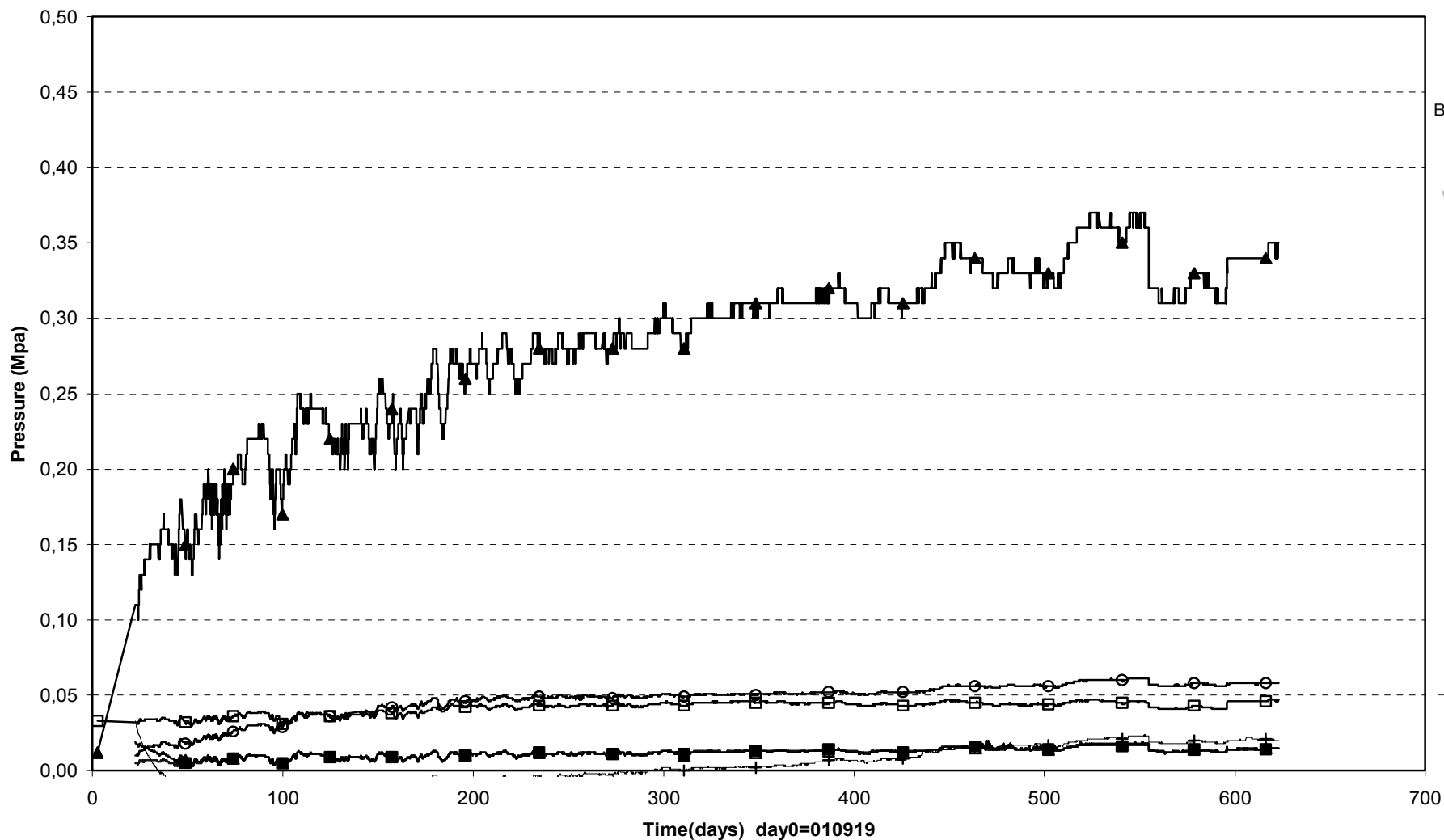

- | | | |
|--|--|--------------------------------|
| □ UBU30001(Cyl.1\190°\0.050) | ▲ UBU30004(Cyl.1\355°\0.785) | ○ UBU30006(Ring5\355°\0.785) |
| + UBU30007(Ring.5\85°\0.535\In the slot) | ■ UBU30008(Ring.5\85°\0.825\In the slot) | △ UBU300011(Ring10\355°\0.585) |

Prototype\Hole 3\Cyl.1 (010917-030601)
 Temperature - Pentronic

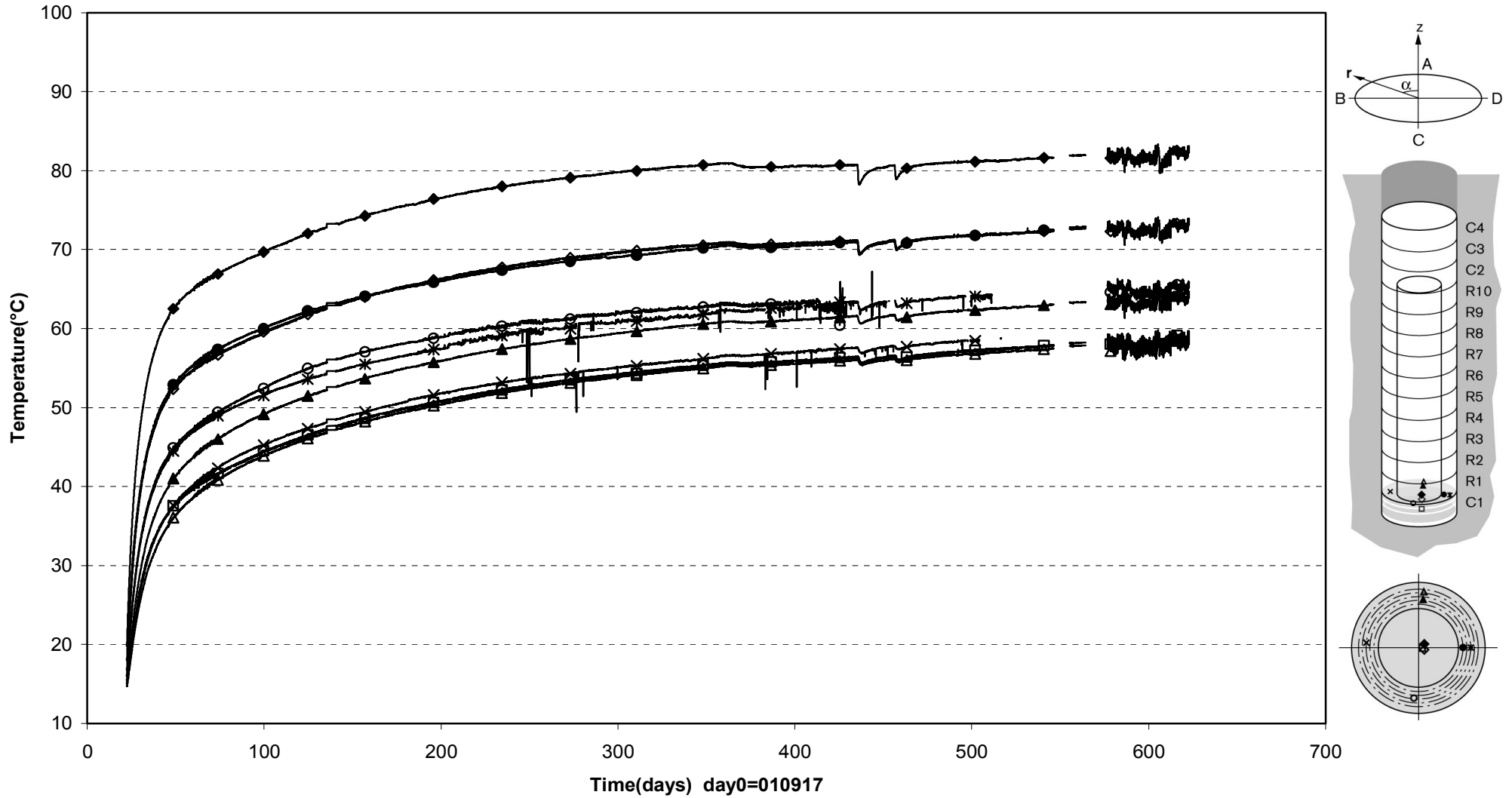

Prototype\Hole 3\Ring5 (010917-030601)
 Temperature - Pentronic

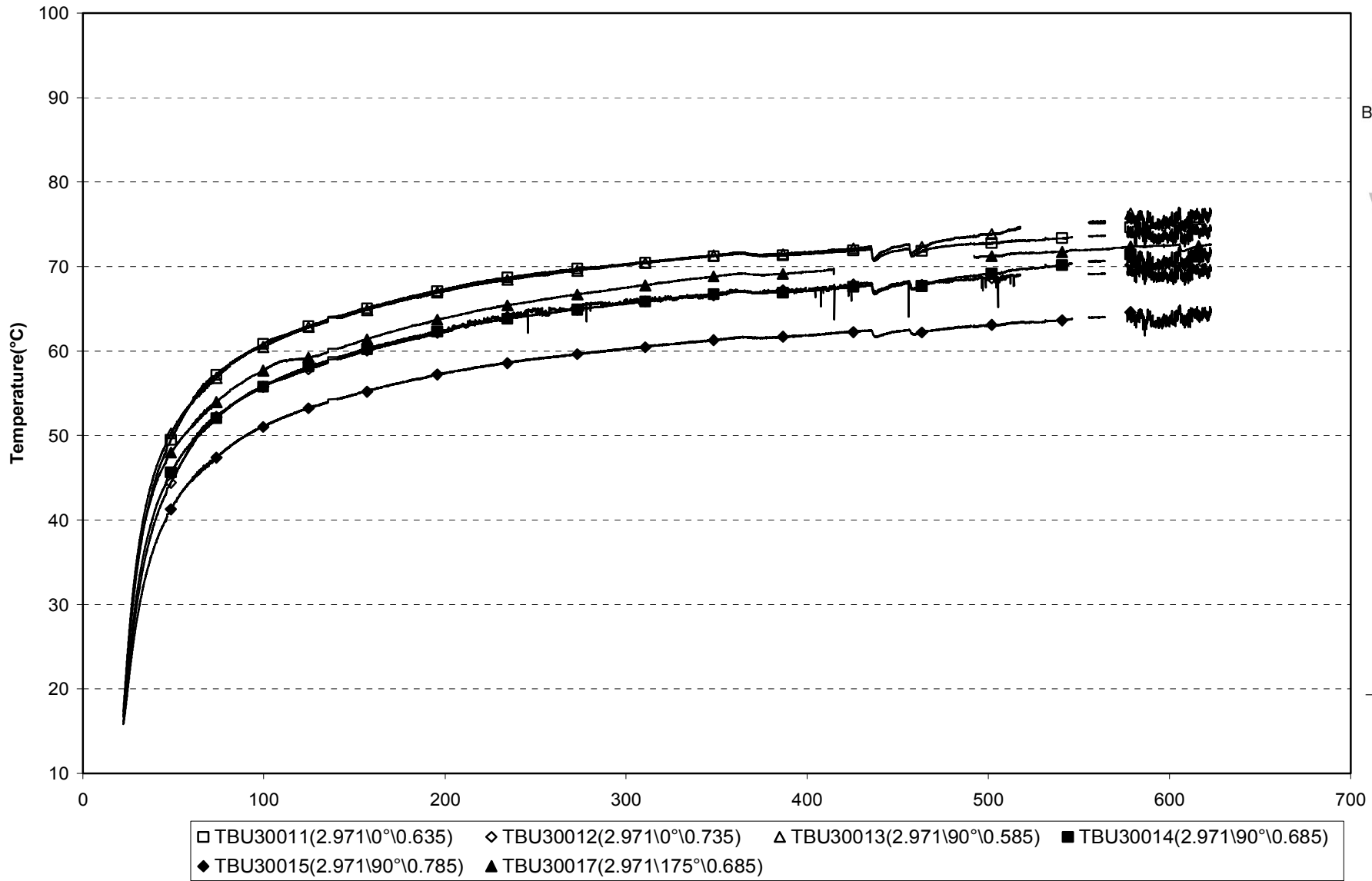

Prototype\Hole 3\Ring5 (010917-030601)
 Temperature - Pentronic

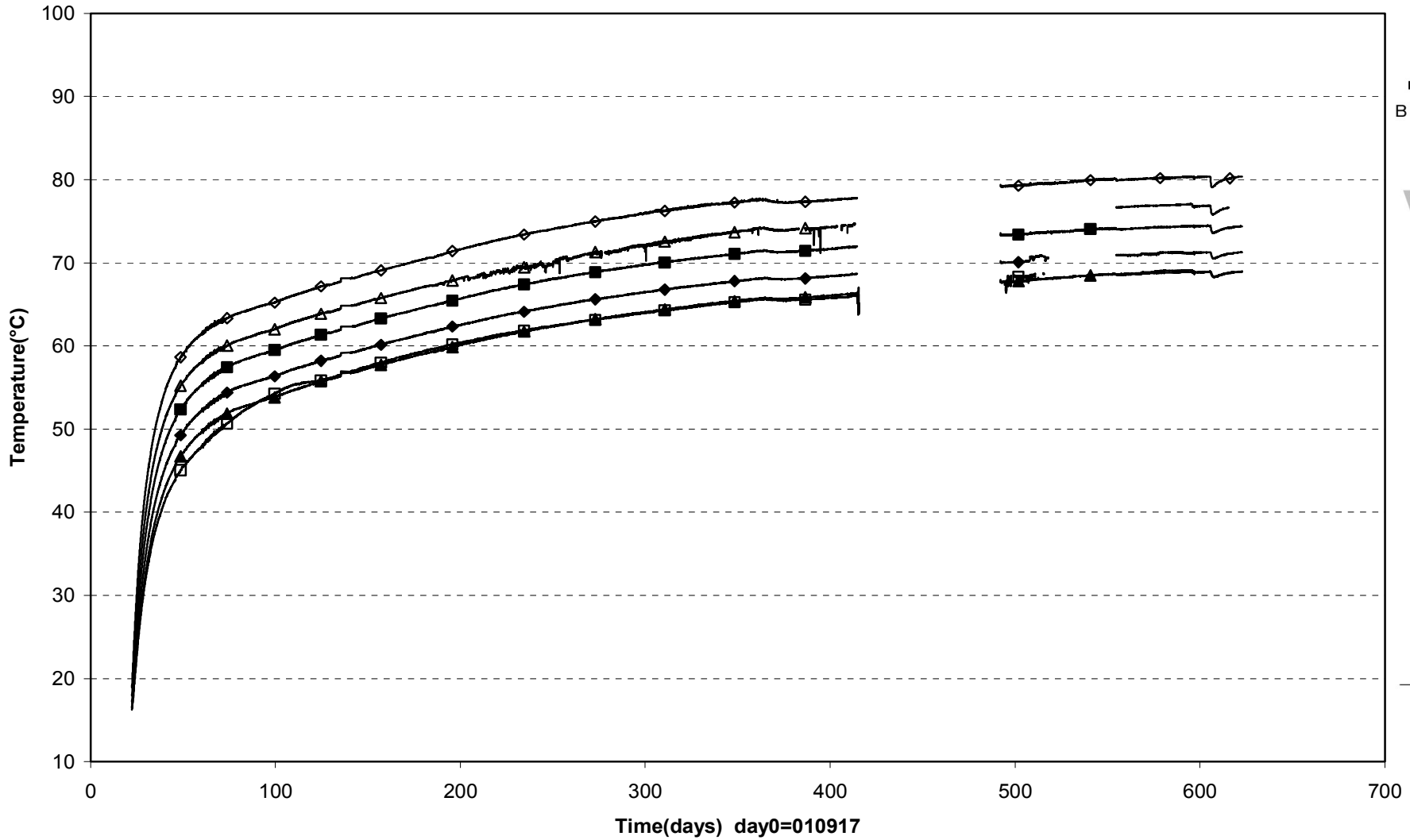

□ TBU30018(2.971\175°\0.735) ◇ TBU30019(2.971\270°\0.585) △ TBU30020(2.971\270°\0.635) ■ TBU30021(2.971\270°\0.685)
 ◆ TBU30022(2.971\270°\0.735) ▲ TBU30023(2.971\270°\0.785)

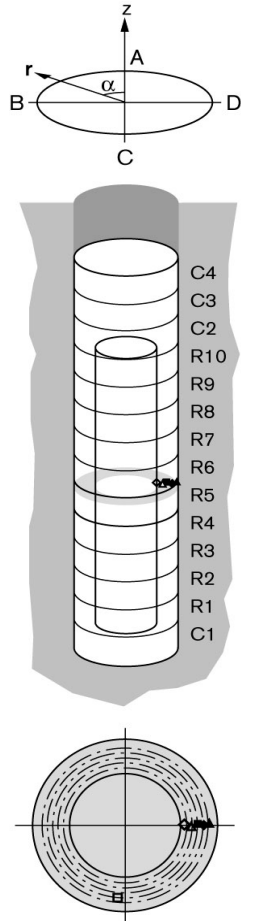

Prototype\Hole 3\Ring10 (010917-030601)
 Temperature - Pentronic

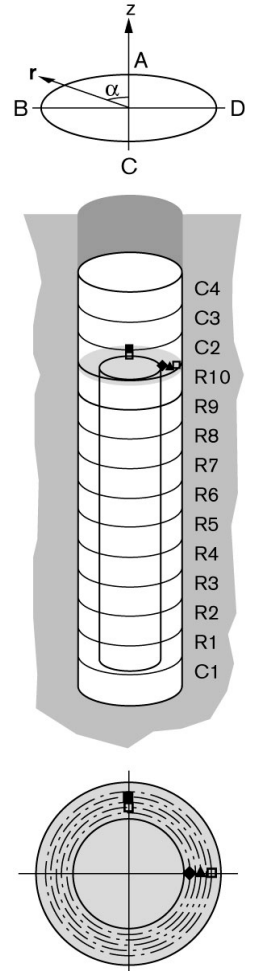
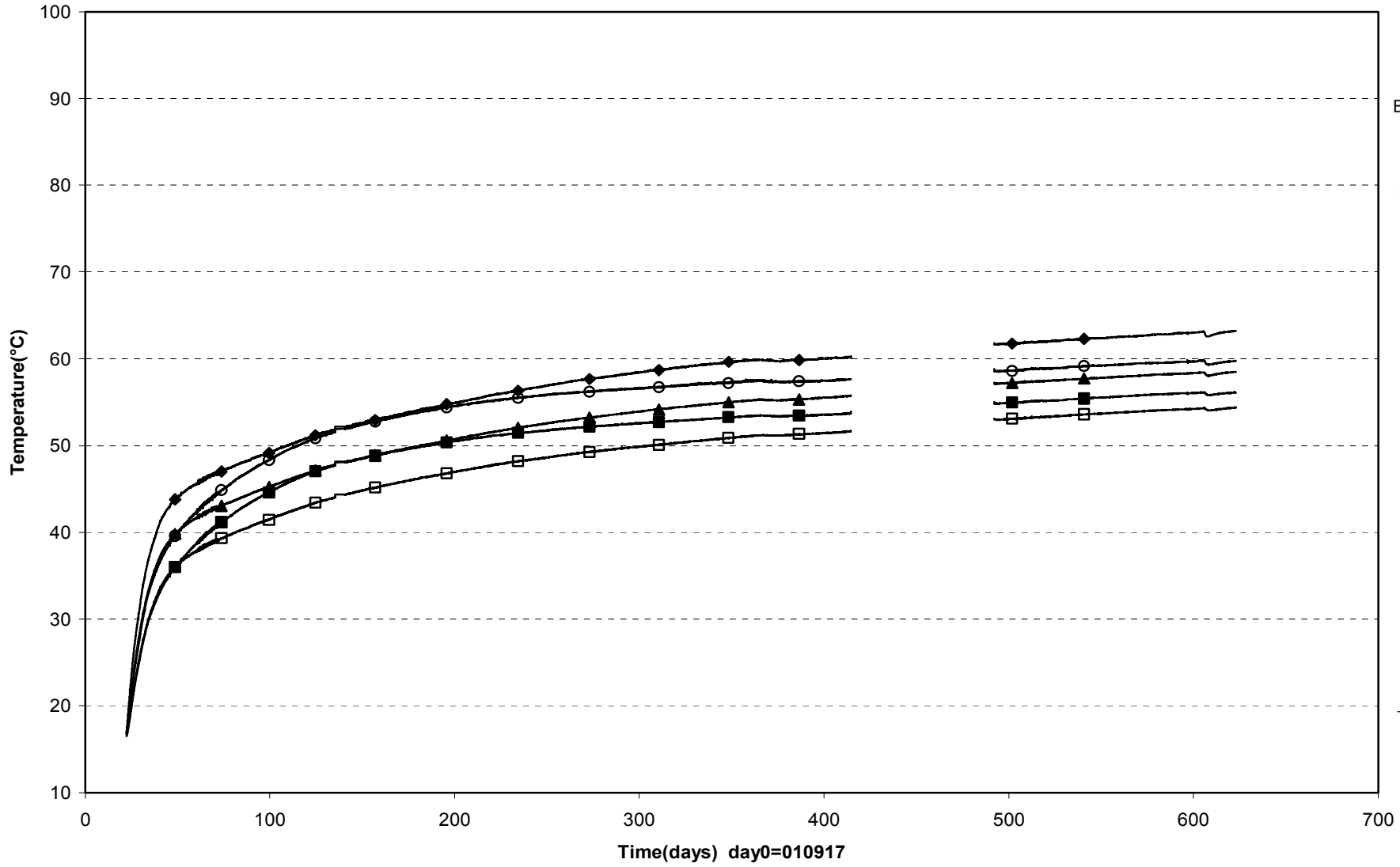

Prototype\Hole 3\Cyl.3 and Cyl.4 (010917-030601)
 Temperature - Pentronic

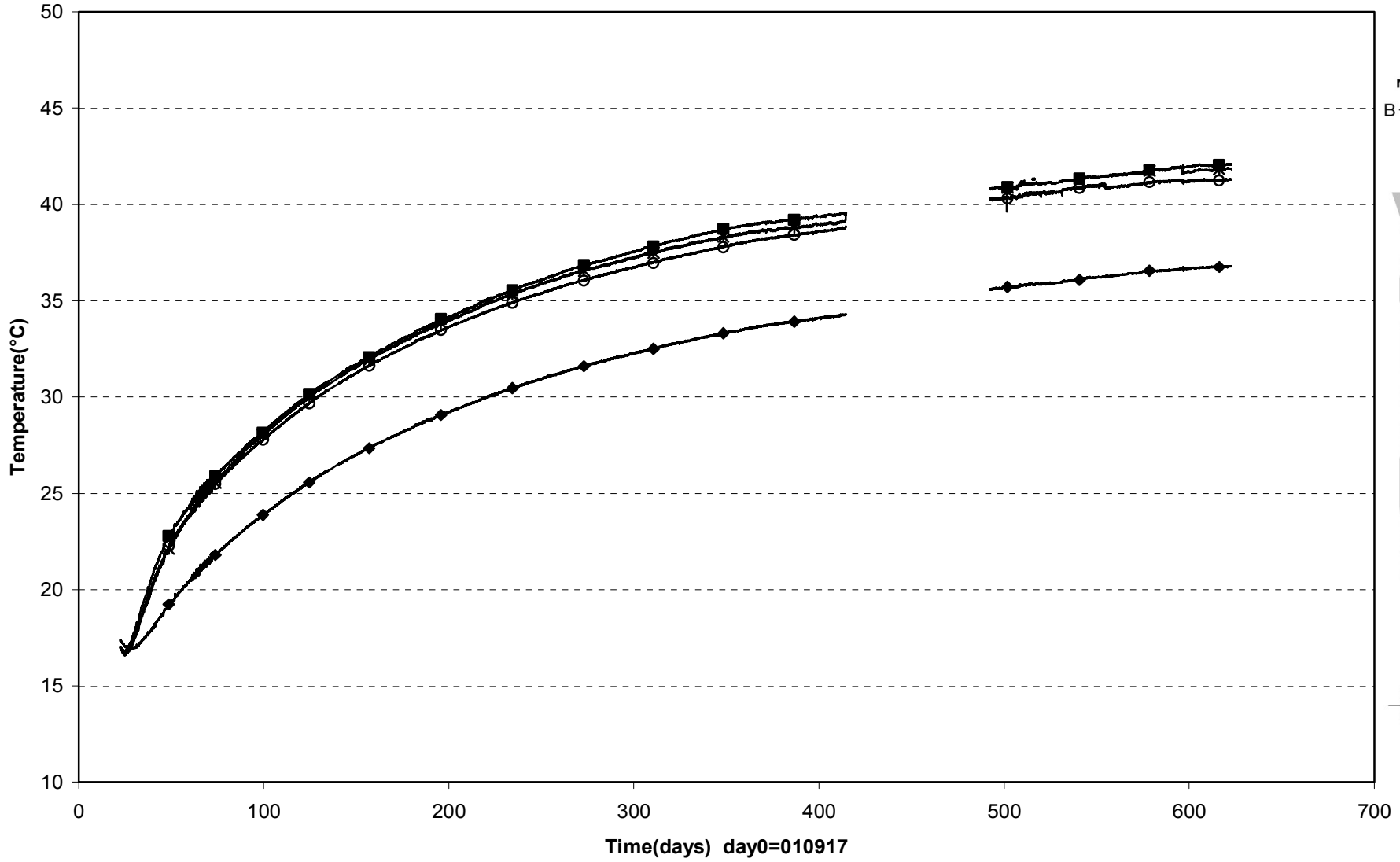

× TBU30029(6.314\0°\0.785) ○ TBU30030(6.314\95°\0.585) ■ TBU30031(6.314\185°\0.585) ◆ TBU30032(7.015\0°\0.785)

Prototype\Rock\Hole 3 (010917-030601)
 Temperature - Pentronic

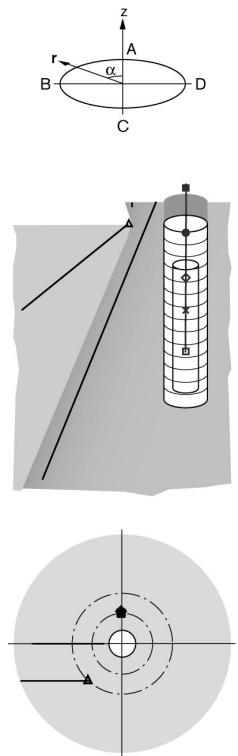
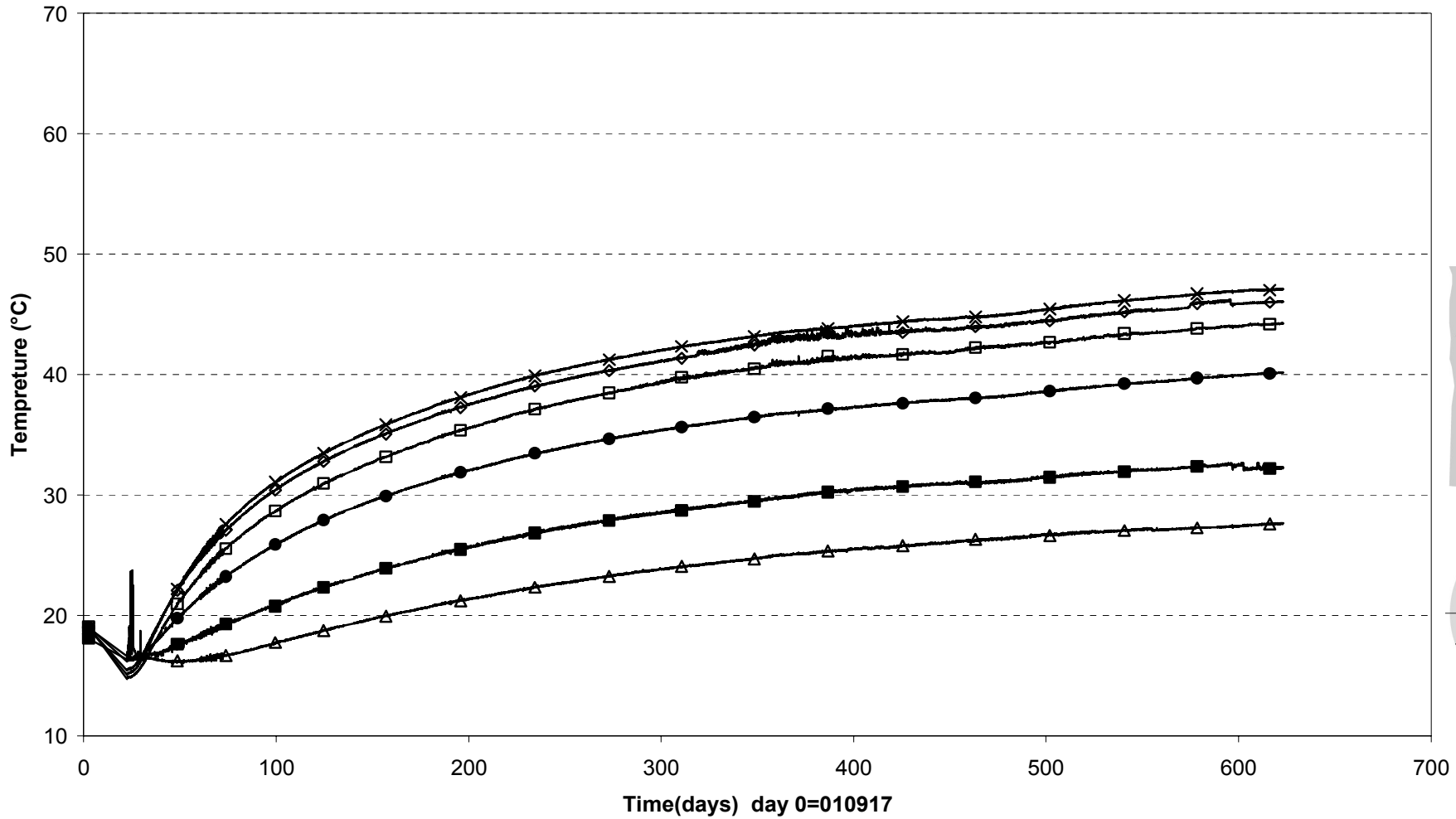

△ TROA2150(7.958\134°\3.284)	● TROA2140 (5.979\1°\1.999)	◇ TROA2130(4.230\2°\1.981)
× TROA2120(2.840\2°\1.967)	□ TROA2110(1.170\3°\1.950)	■ TROA1850 (7.889\0°\2.019)

Prototype\Rock\Hole 3 (010917-030601)
 Temperature - Pentronic

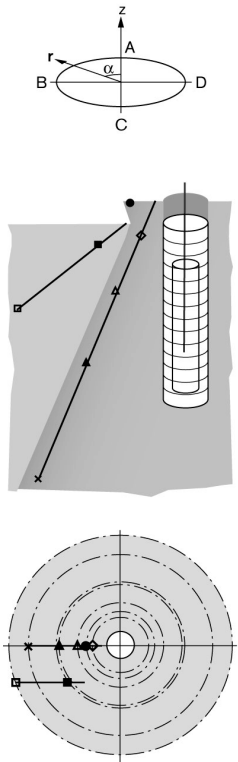
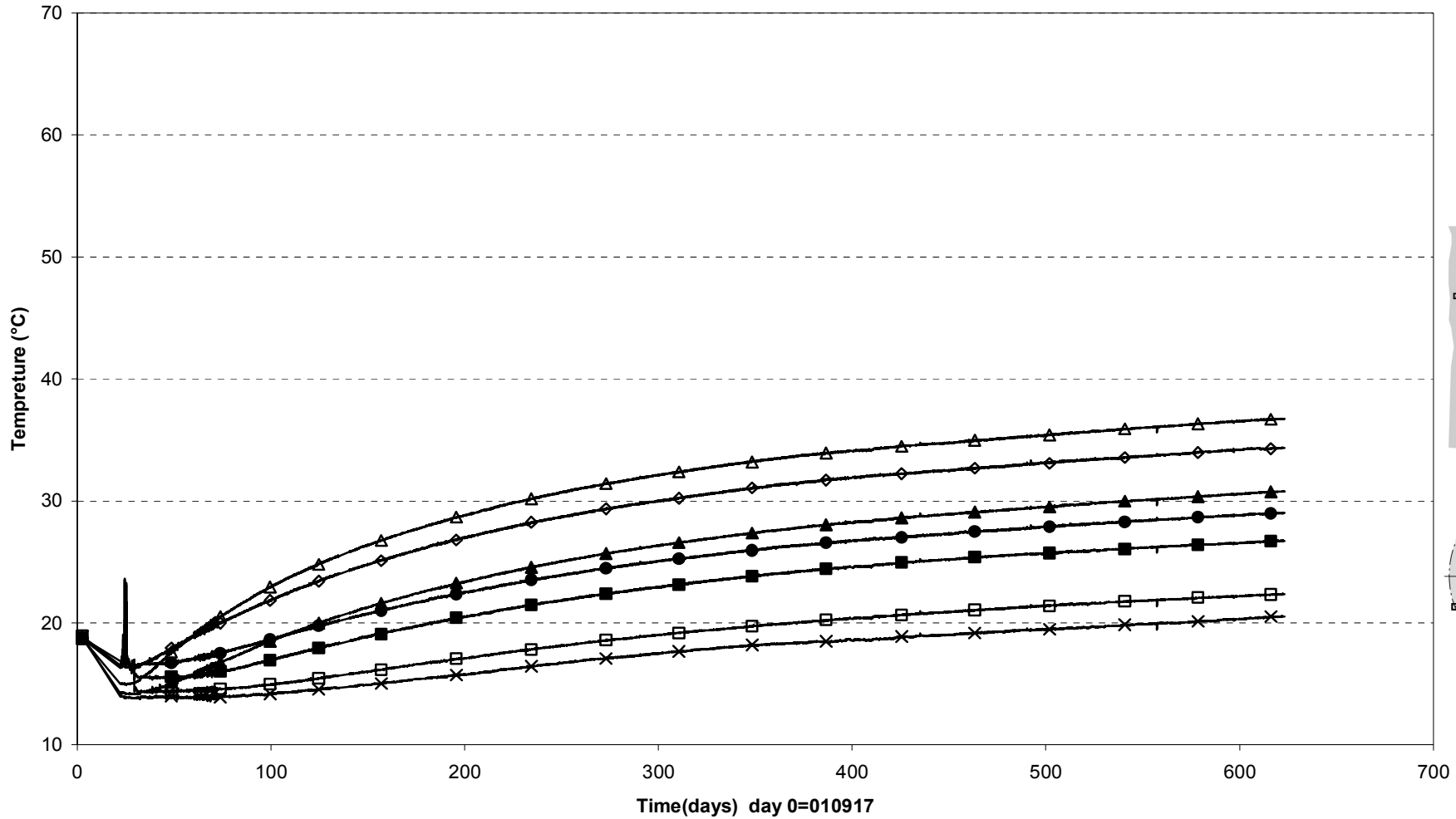

- | | | | |
|------------------------------|------------------------------|------------------------------|-------------------------------|
| ● TROA2330(7.924\90°\2.169) | ◇ TROA2320 (6.632\90°\1.787) | □ TROA2310(4.640\109°\7.111) | ■ TROA2440 (7.174\124°\4.088) |
| △ TROA2430 (4.319\90°\4.319) | ▲ TROA2420(1.451\89°\3.914) | × TROA2410(-3.295\89°\5.861) | |

Prototype\Hole 3\ On canister top (010917-030601)
Temperature - Pentronic

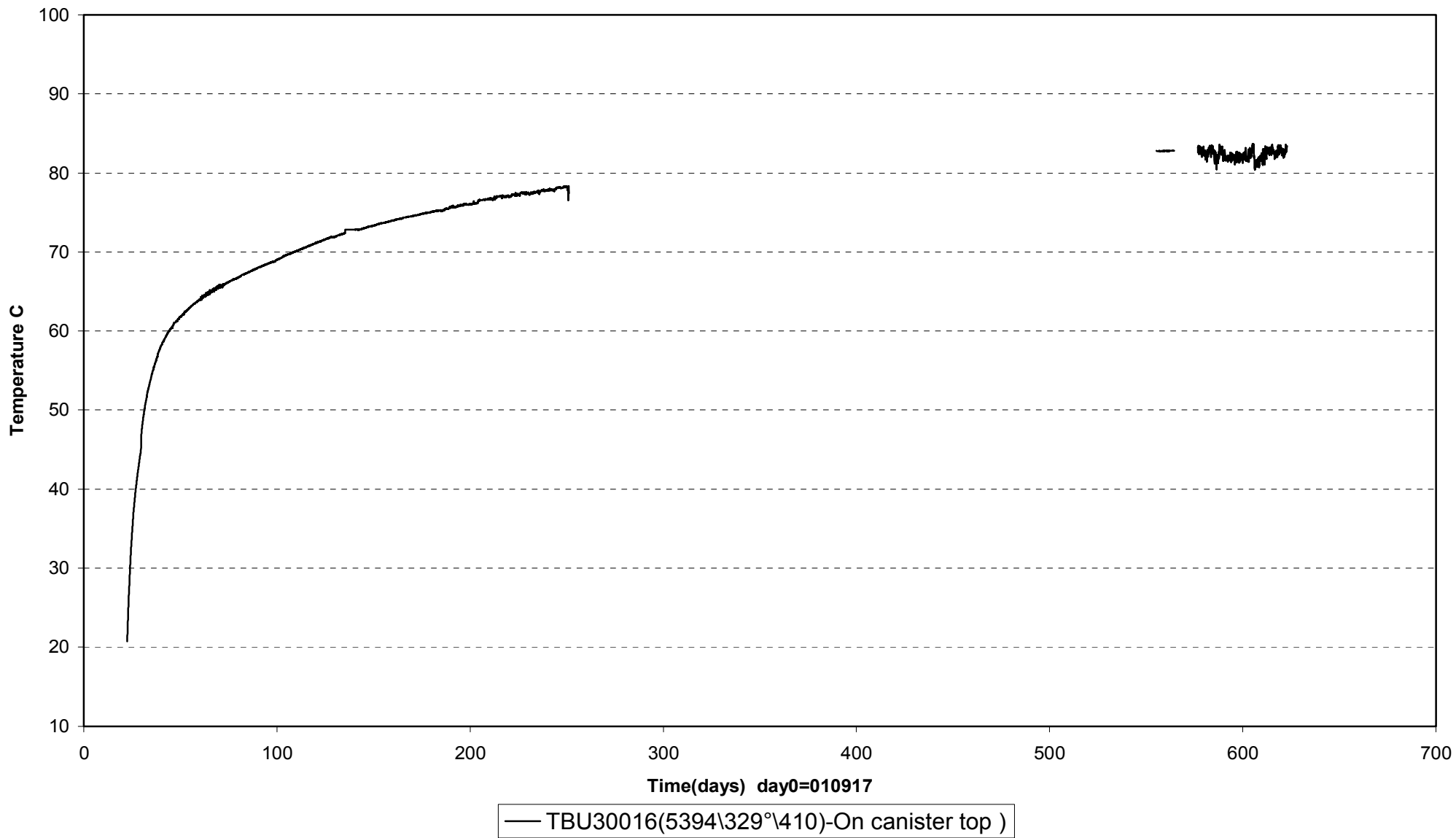

Prototype\ Hole 3 (010917-030601)
Canister power

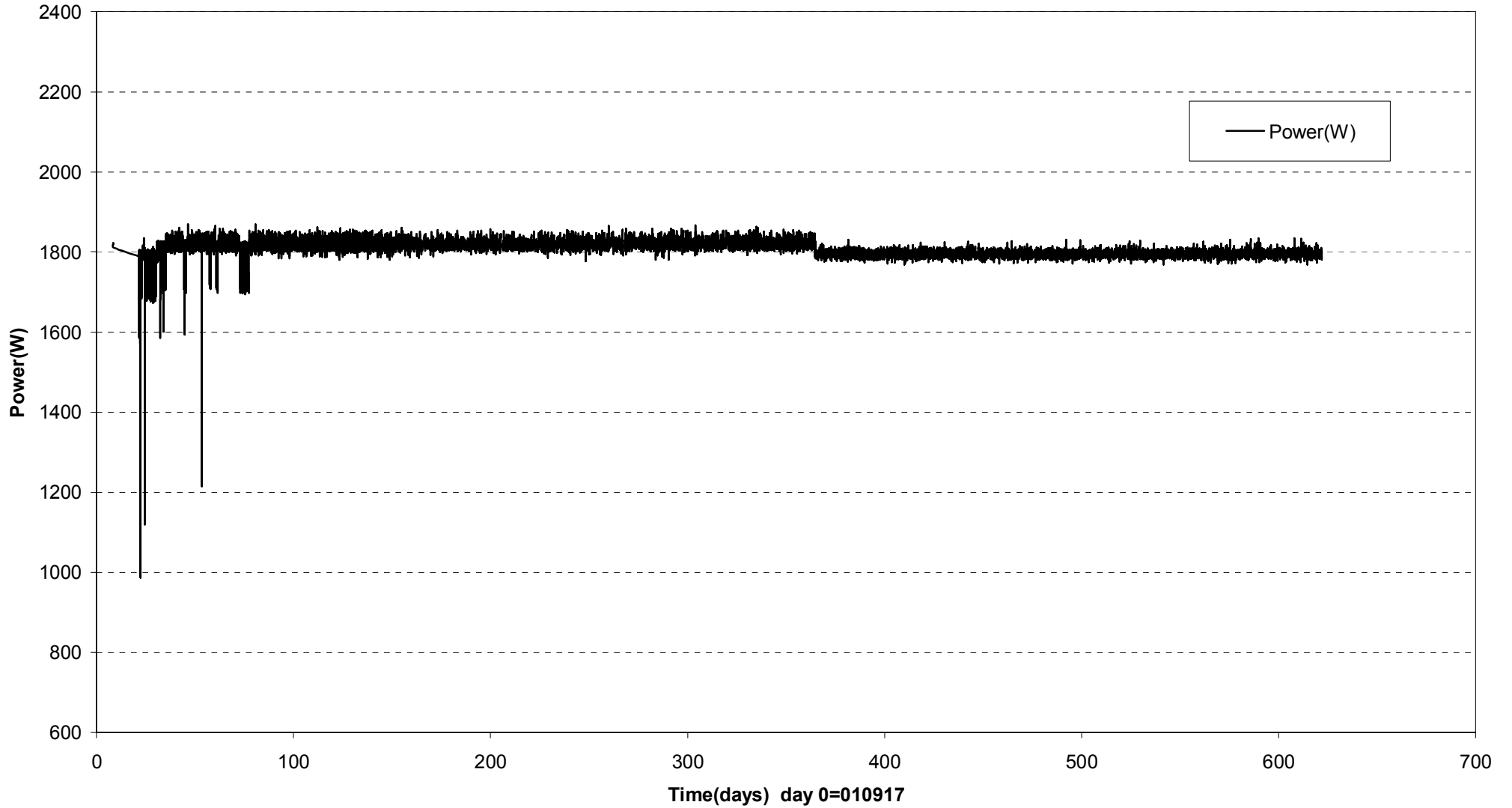

Prototype\ Hole 3 \Canister (010917-030601)
 Max. temperature on the canister surface - Optical fiber cables

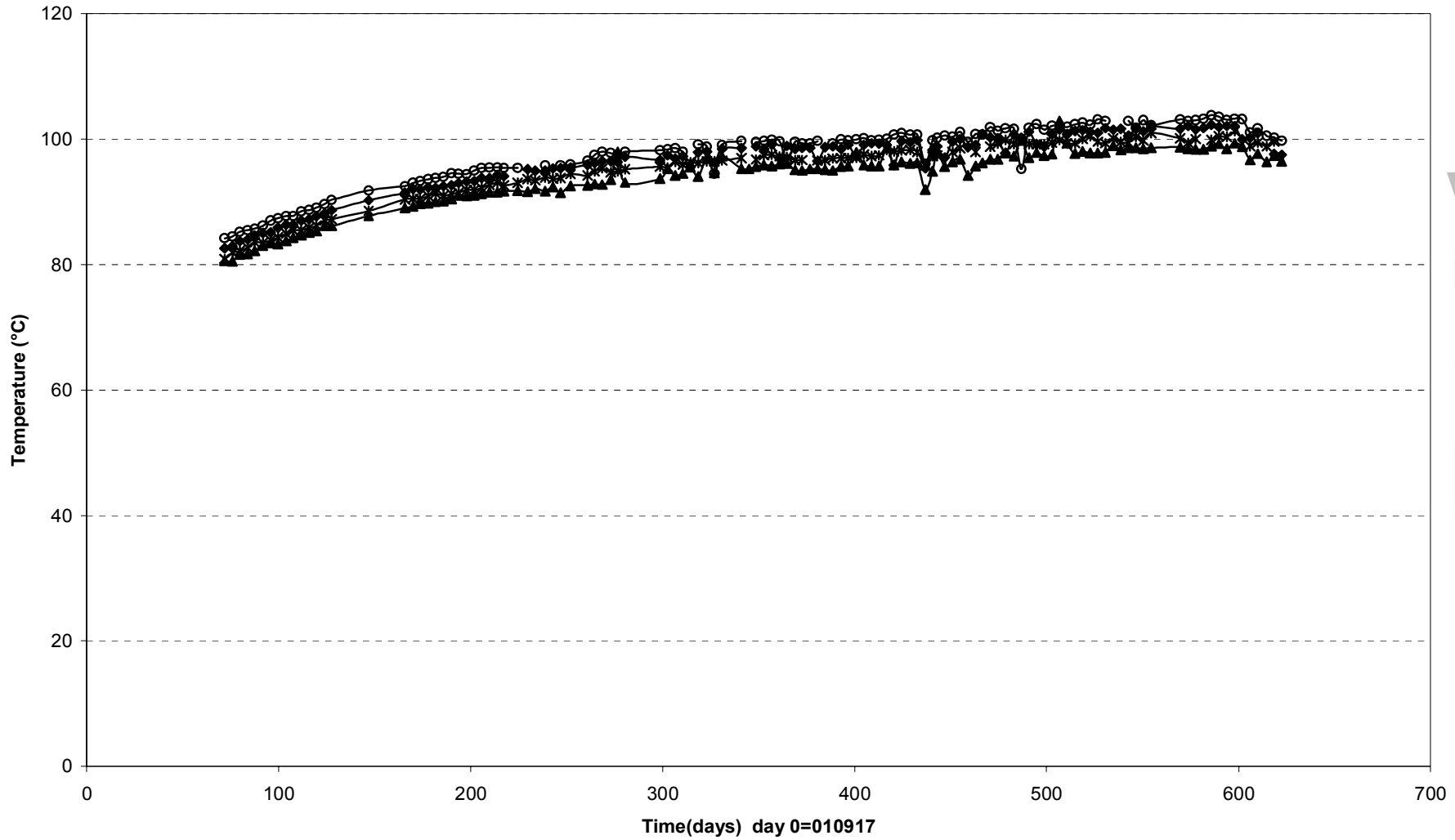

—○— Cable 1, outlet (chanal6)°C —*— Cable 1, inlet (chanal10)°C —▲— Cable 2, outlet (chanal11)°C —◆— Cable 2, inlet (chanal12)°C

Prototype\ Hole 3 \Canister (030601)
Temperature profile on the canister surface - Optical fiber cables

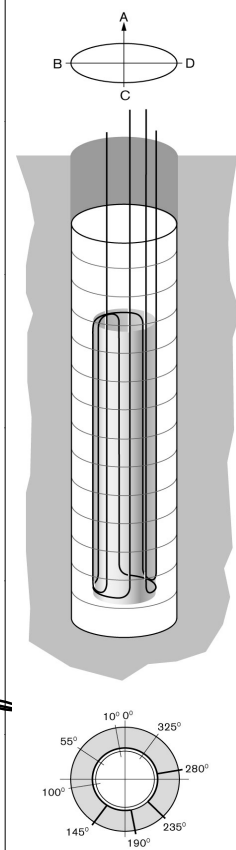
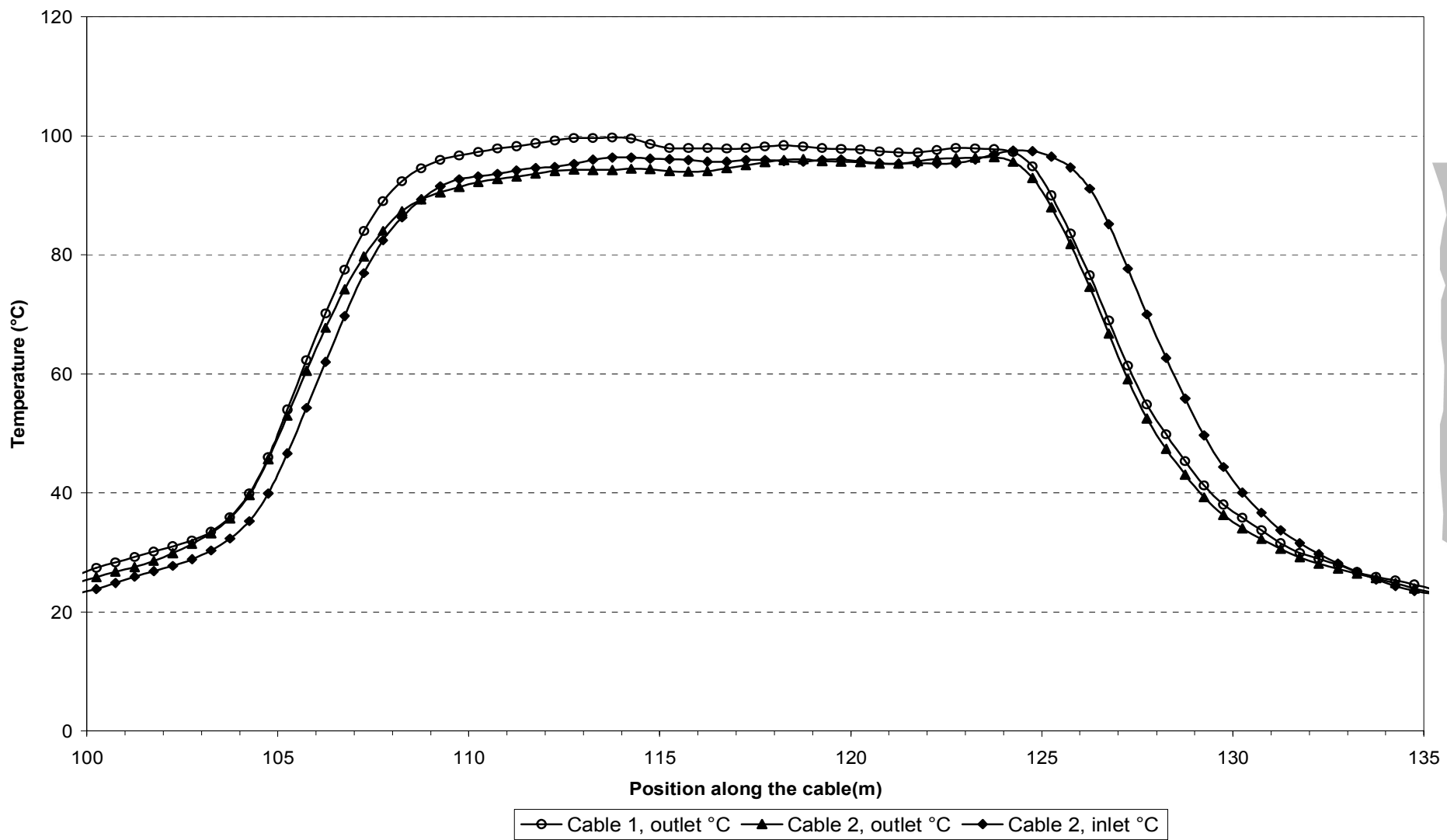

Appendix 3

Dep. holes 2 and 4

Prototype\Rock\Hole 2 (010917-030601)
 Temperature - Pentronic

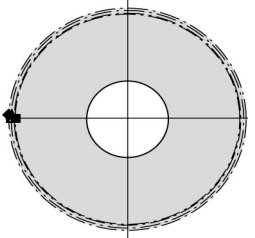
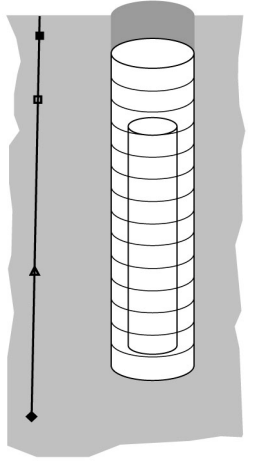
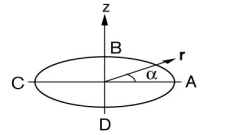
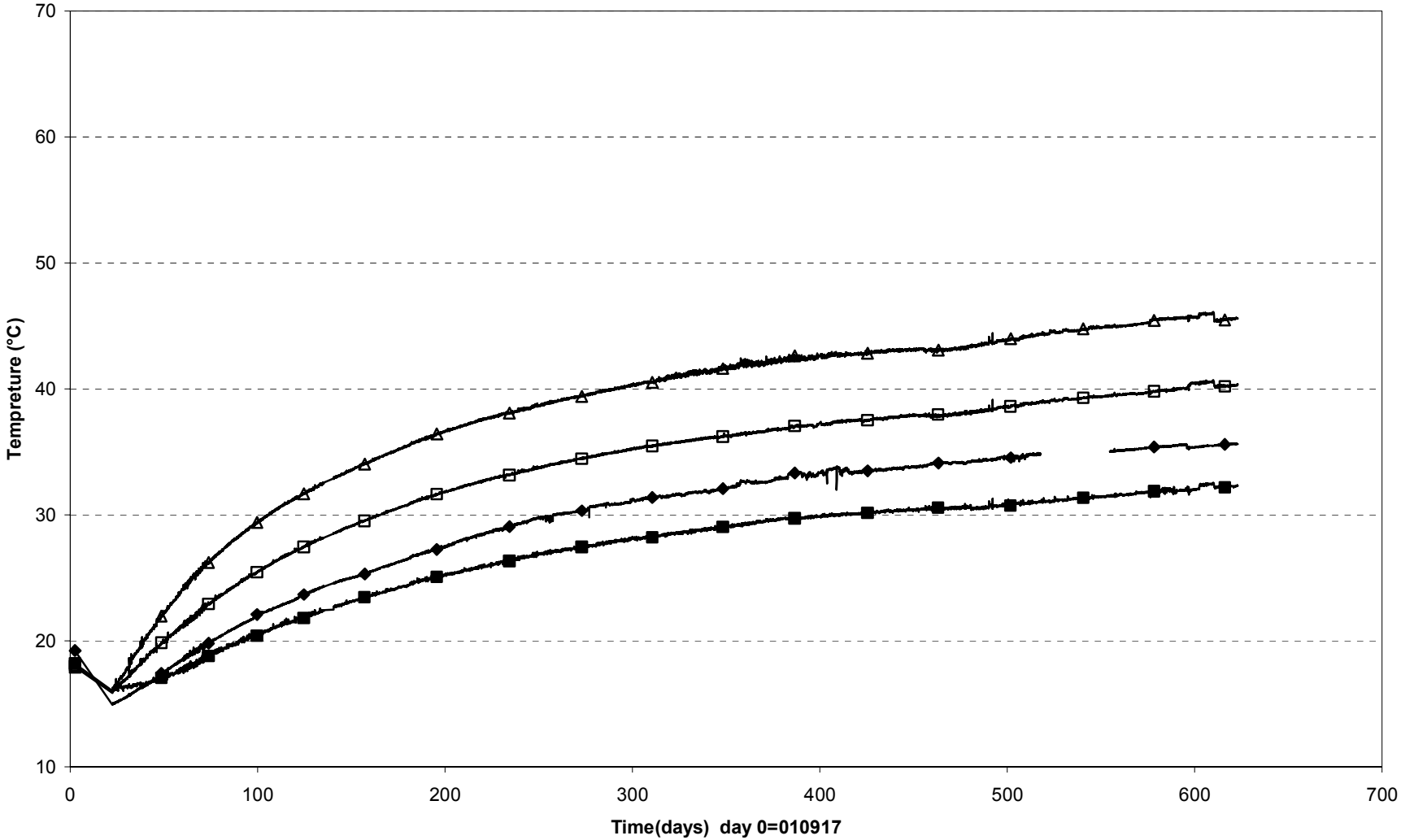

■ TROA1840(7.587\180°\2.404) □ TROA1830 (6.087\180°\2.427) △ TROA1820(2.138\179°\2.490) ◆ TROA1810 (-1.162\179°\2.542)

Prototype\ Hole 2 (010917-030601)
Canister power

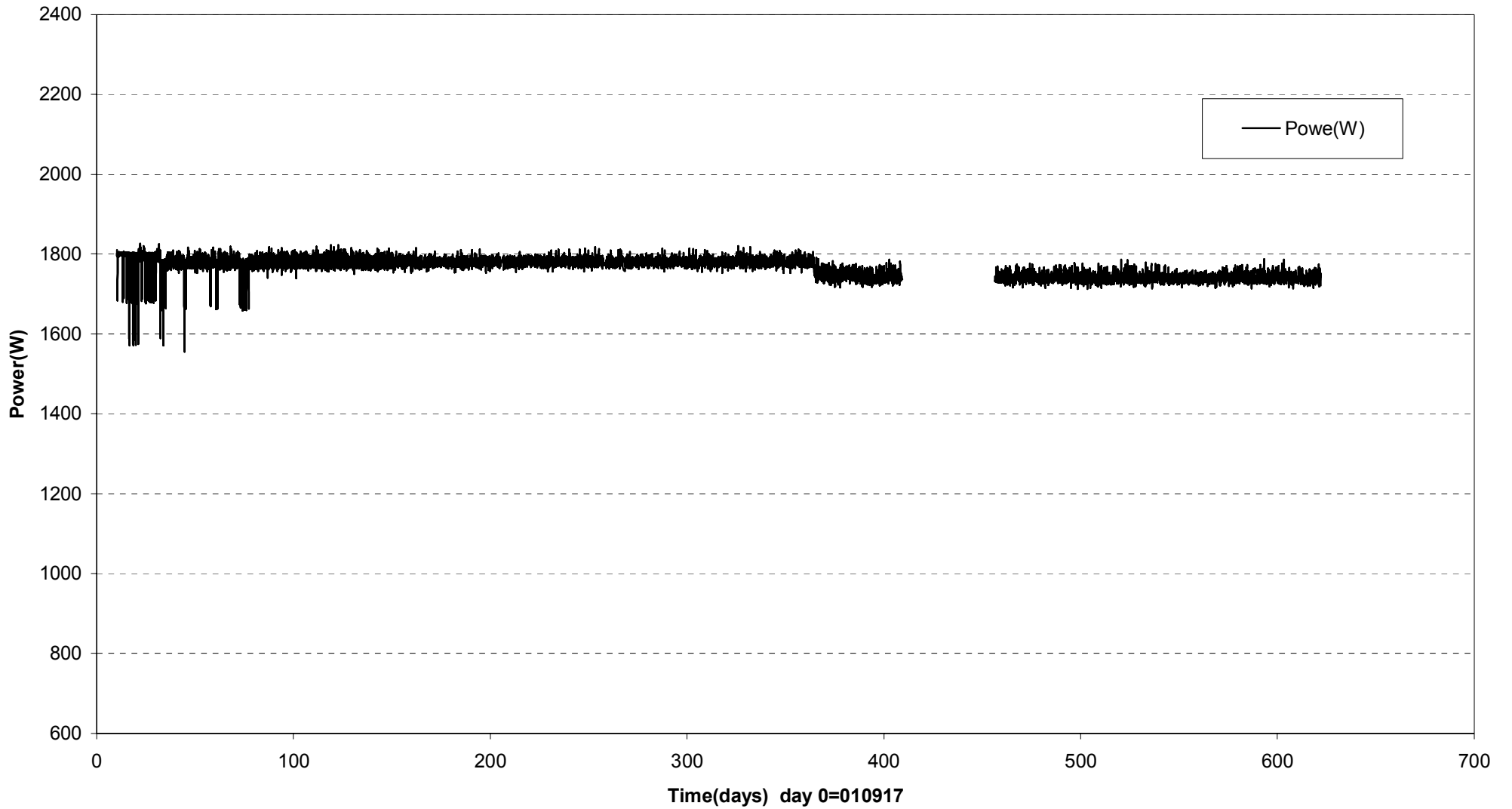

Prototype\ Hole 2 \Canister (010917-030601)
 Max. temperature on the canister surface - Optical fiber cables

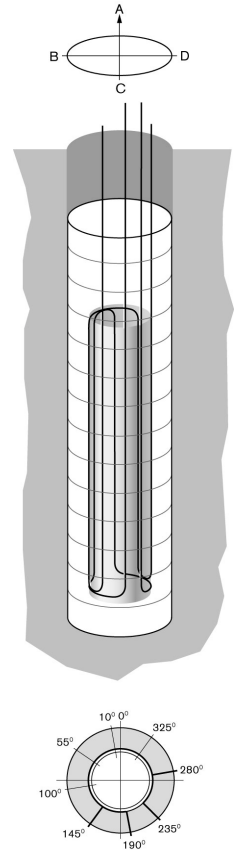
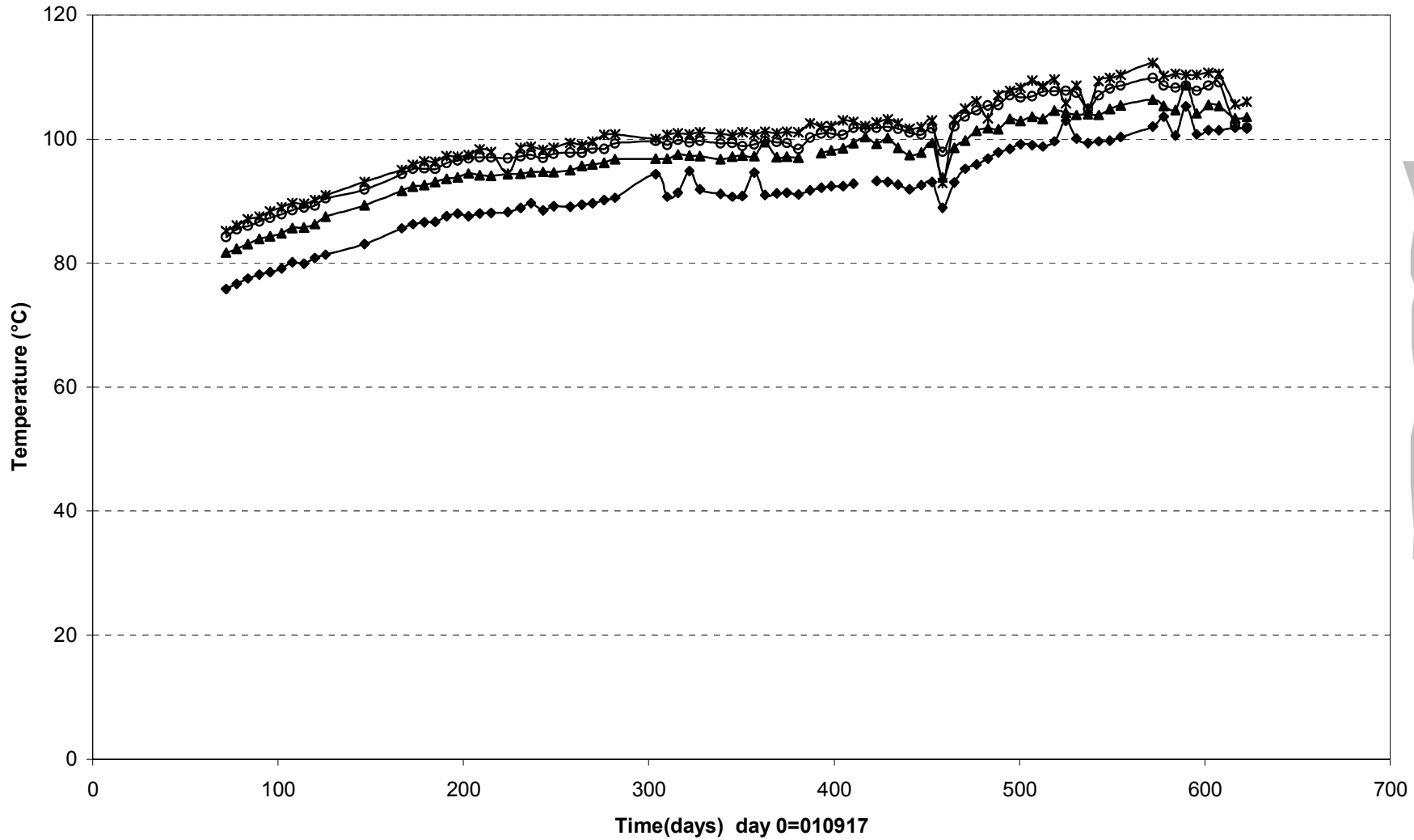

Prototype\ Hole 2 \Canister (030601)
 Temperature profile on the canister surface - Optical fiber cables

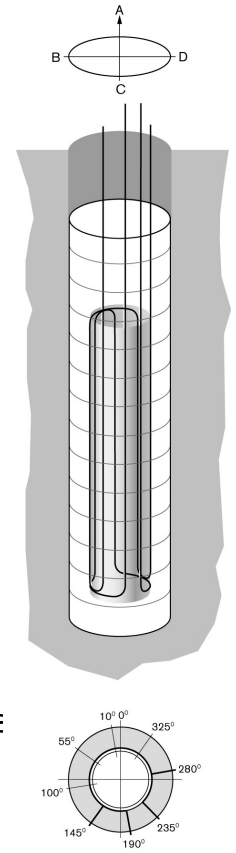
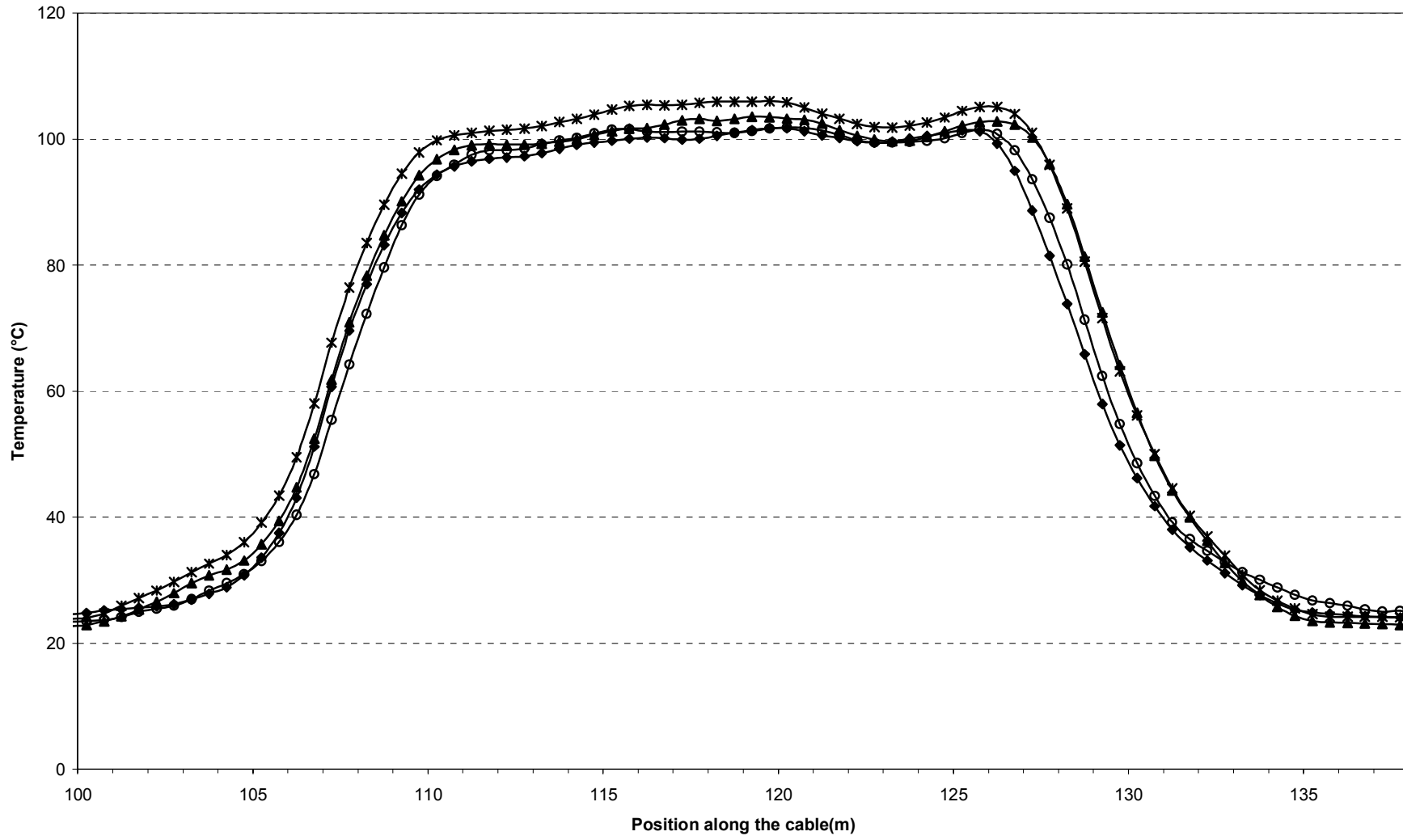

Prototype\Hole 2 \Canister top (010917-030601)
Temperature - Pentronic

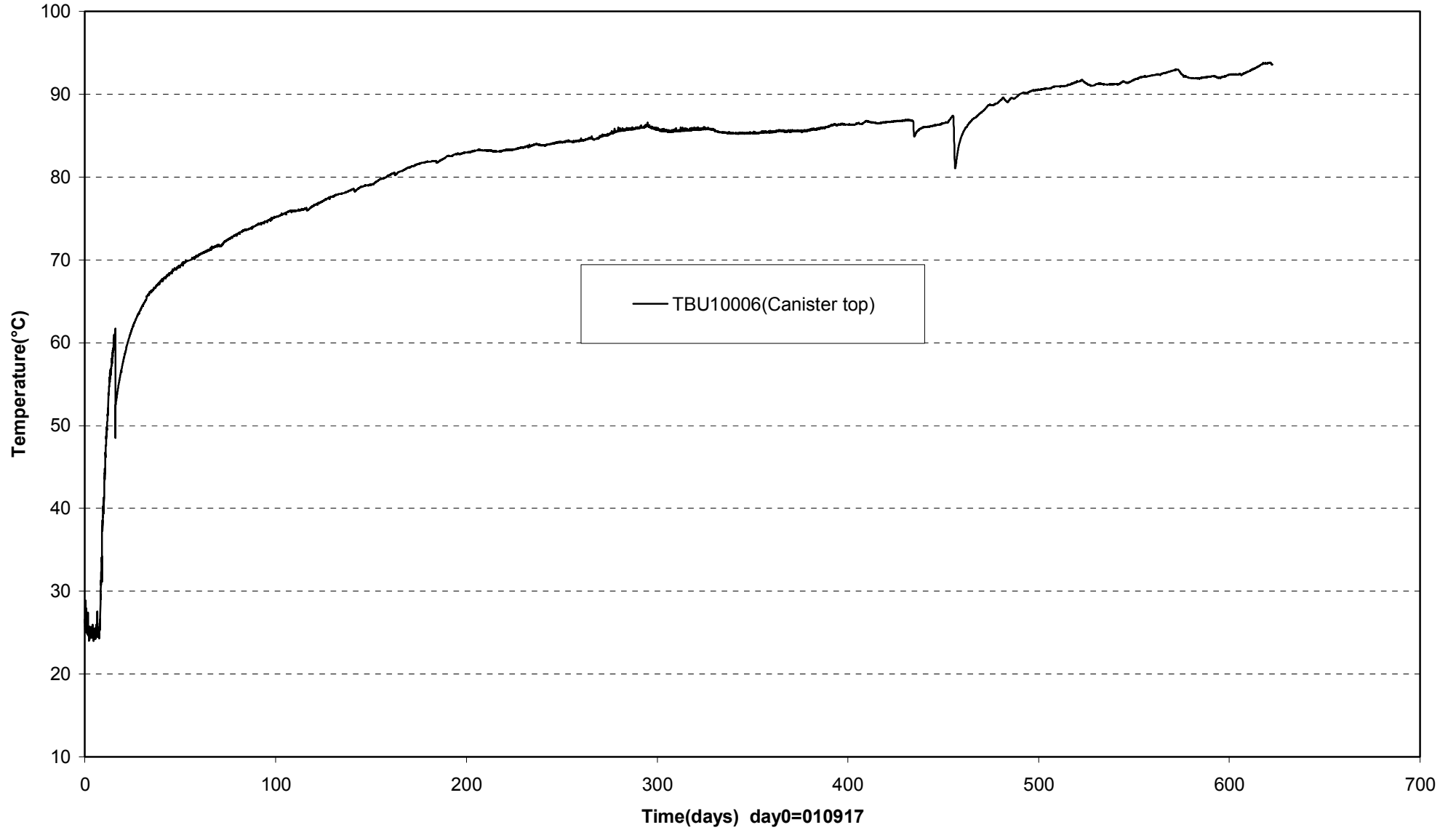

Prototype\Rock\Hole 4 (010917-030601)
 Temperature - Pentronic

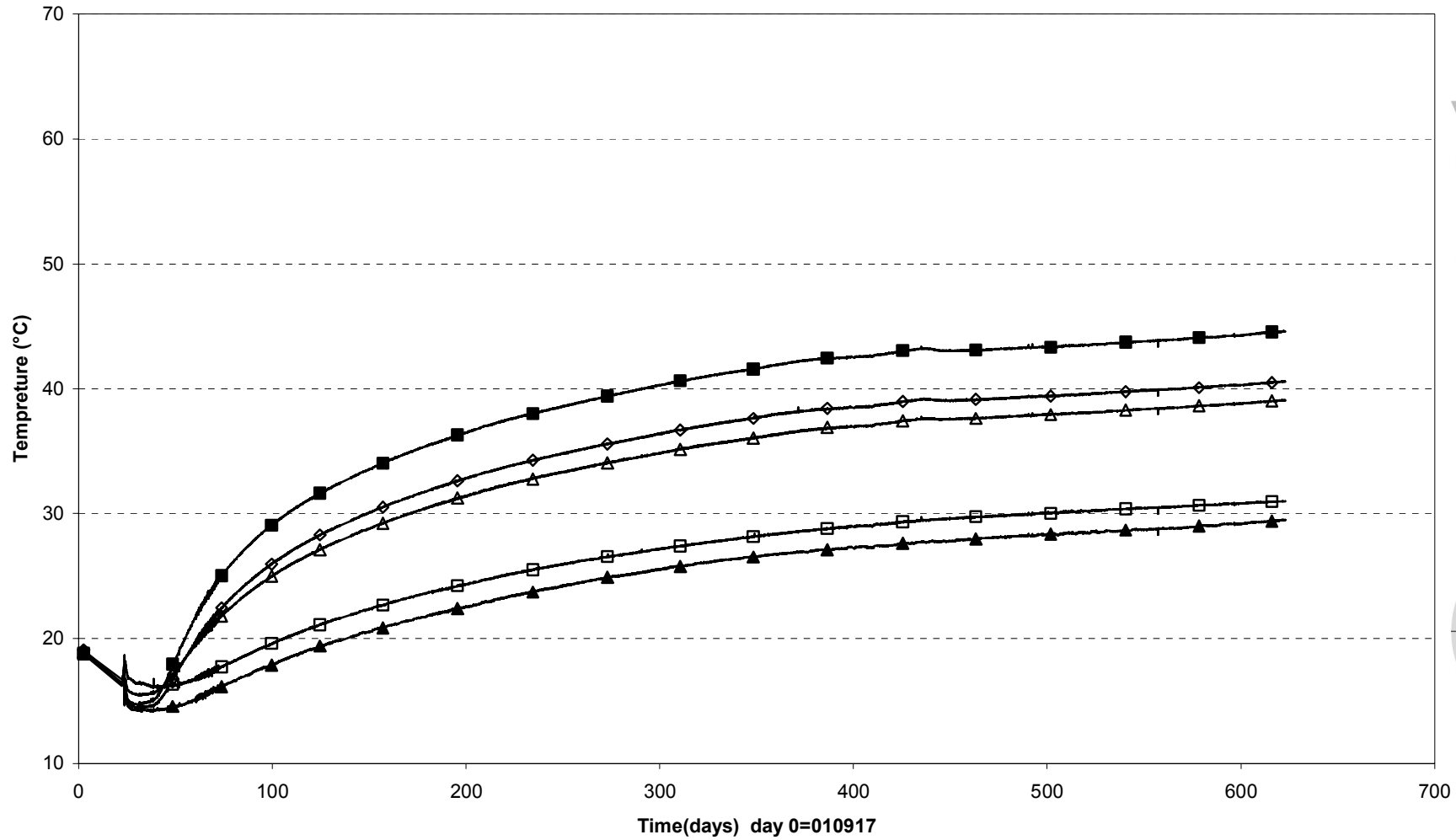

□ TROA3050 (7.671\360°\2.017) △ TROA3040 (5.671\359°\2.025) ■ TROA3030(3.271\358°\2.034)
 ◇ TROA3020(0.871\358°\2.045) ▲ TROA3010(-1.778\357°\2.056)

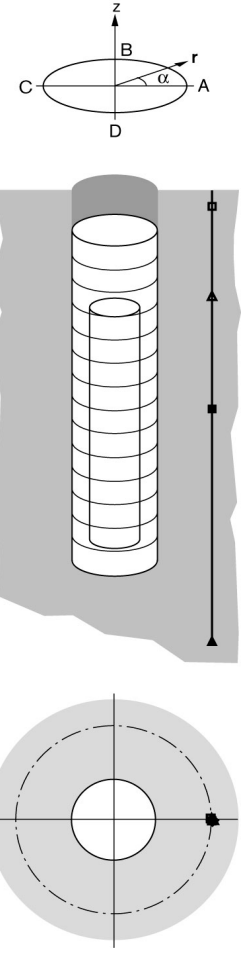

Prototype\Hole 4 (010917-030601)
Canister power

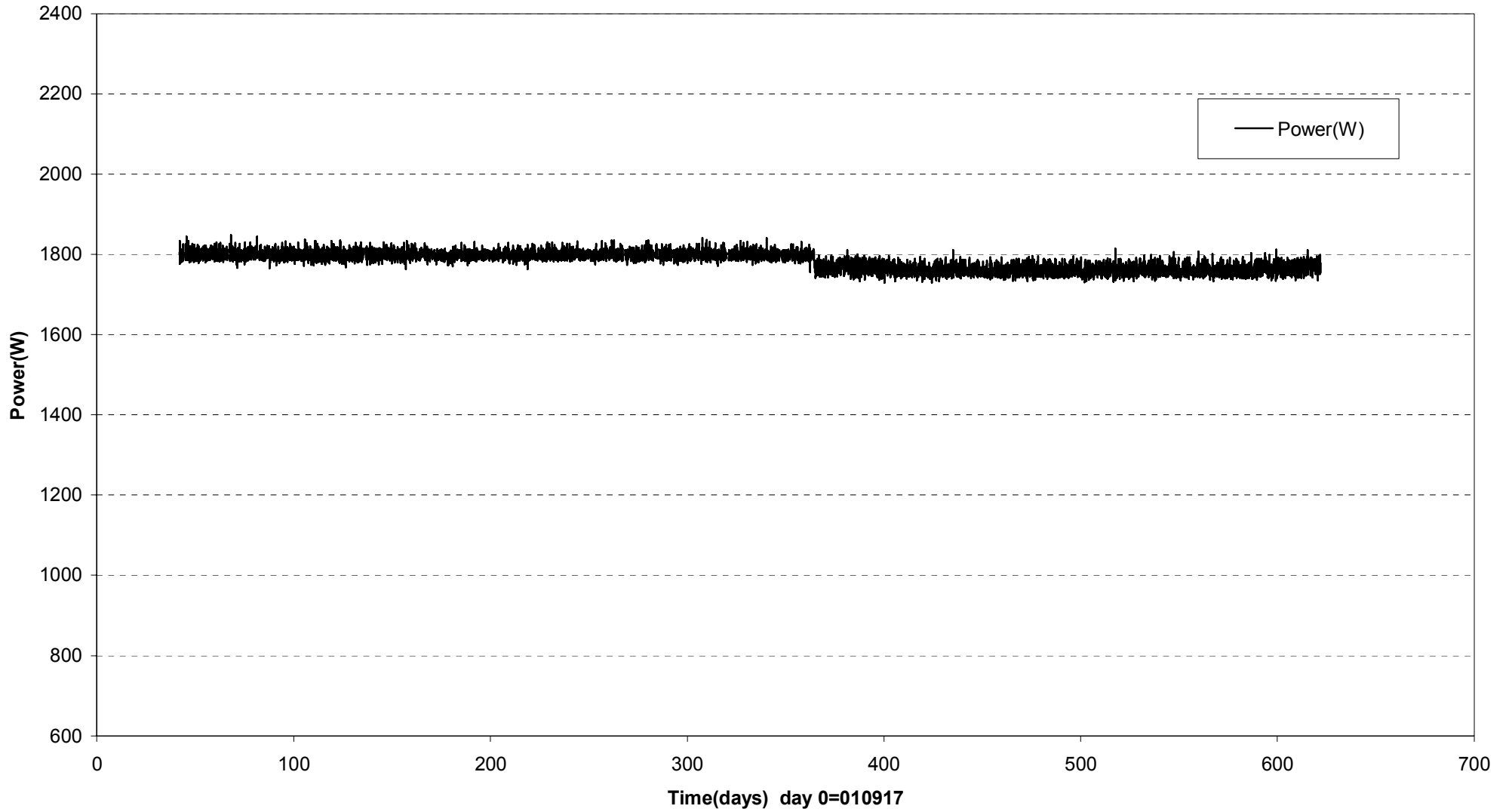

Prototype\ Hole 4 \Canister (010917-030601)
 Max. temperature on the canister surface - Optical fiber cables

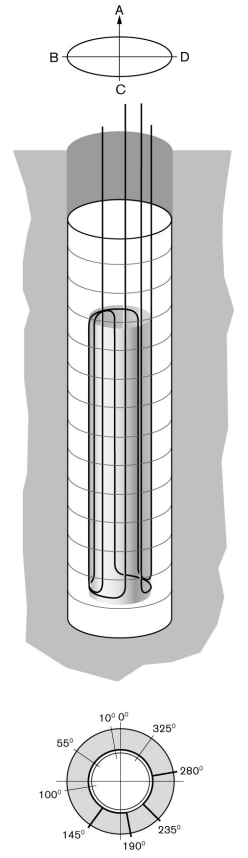
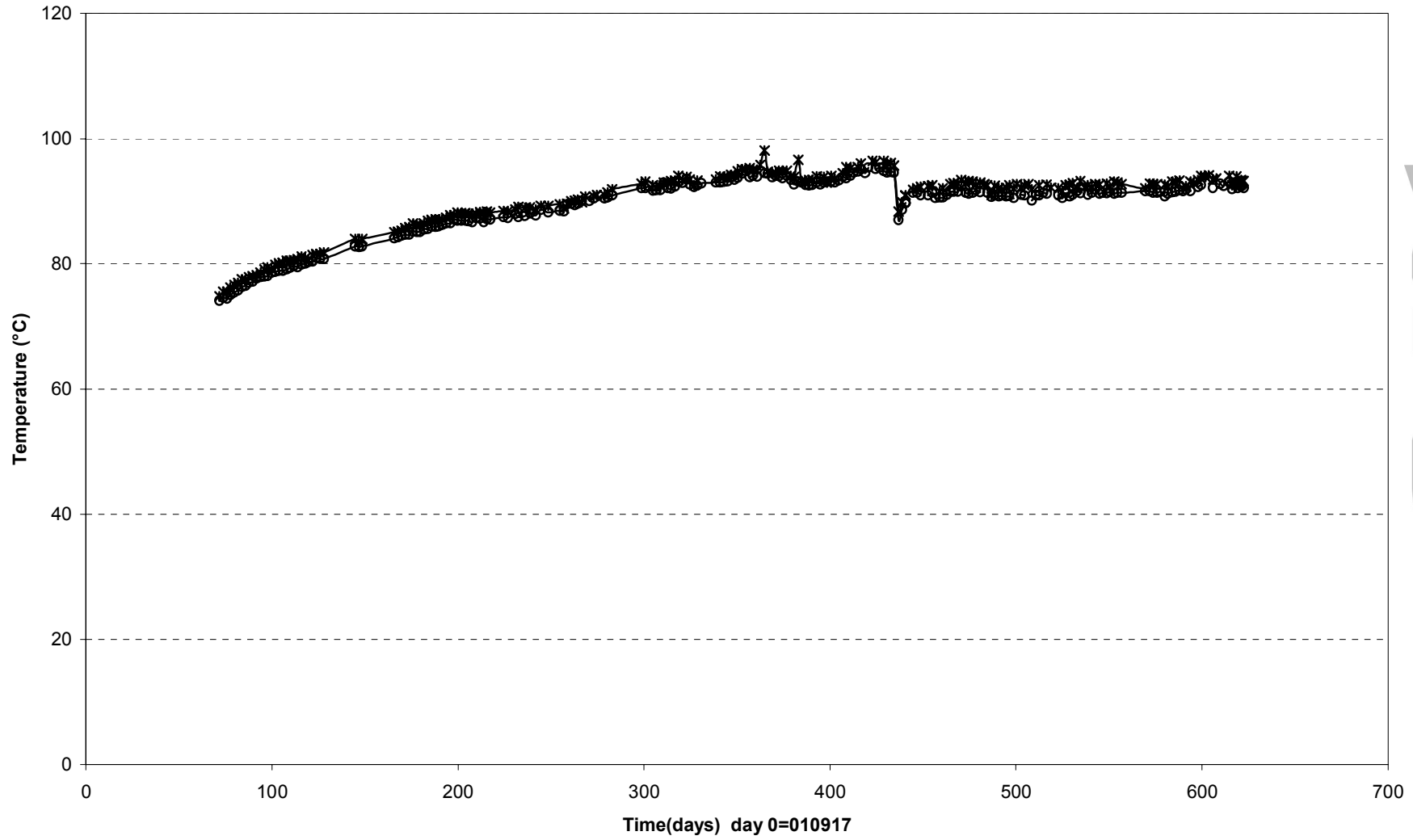

—○— Cable 1, outlet Chanal5°C —*— Cable 1, inlet Chanal7°C —▲— Cable 2, outlet Chanal8°C —◆— Cable 2, inlet Chanal9°C

Prototype\ Hole 4\Canister (030601)
Temperature profile on the canister surface - Optical fiber cables

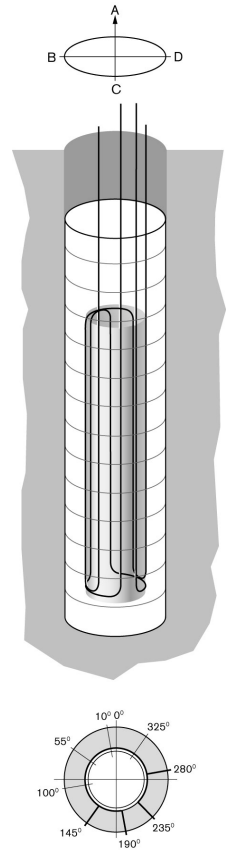
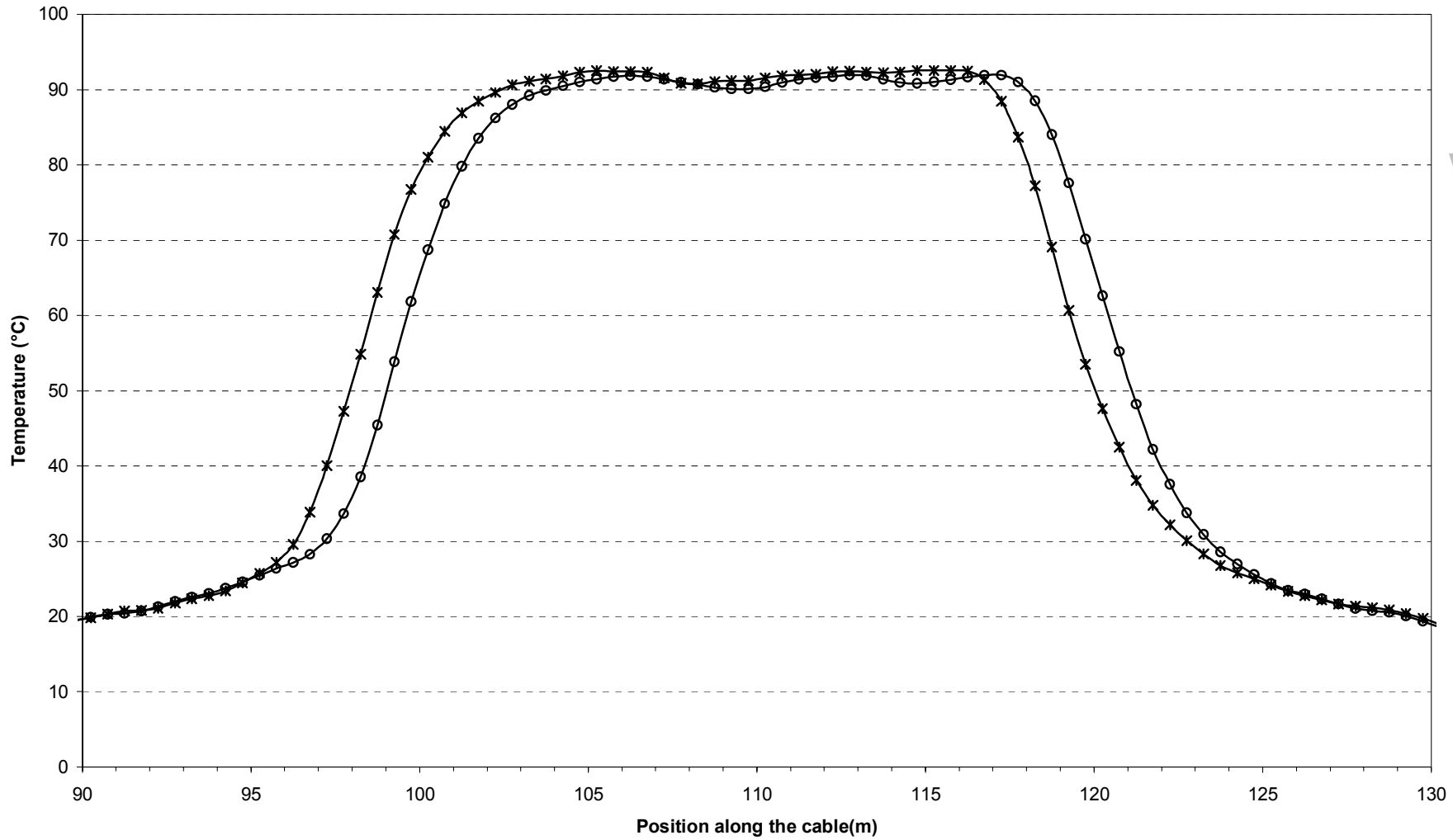

Appendix 4

Backfill

Prototype\Backfill (010917-030601)
Total pressure - Geokon

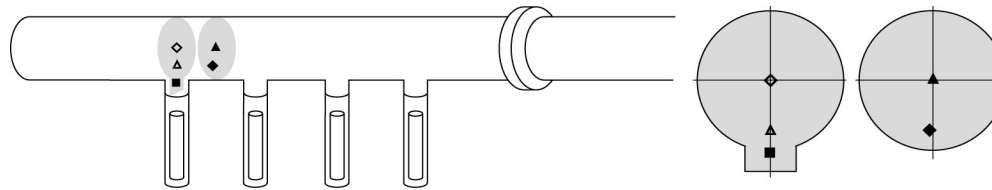
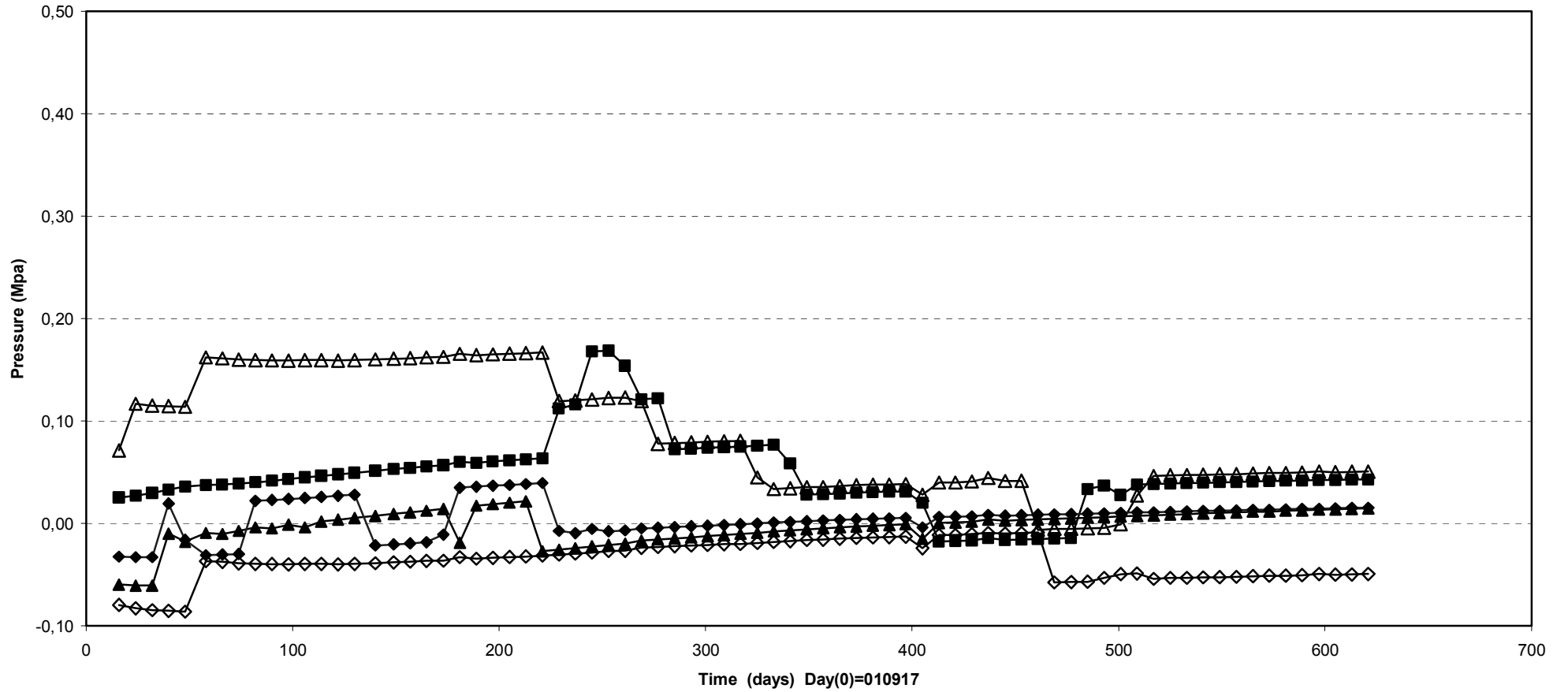

◇ PBA10002(E1\0\0\3587)
△ PBA10003(E1\0 \-1,8\3587)
■ PBA10004(E1\0 \-2,6\3587)
▲ PBA10008(F1-2\0\0\3584)
◆ PBA10009(F1-2\0-0.1\1,8\3584)

Prototype\Backfill (010917-030601)
Total pressure - Geokon

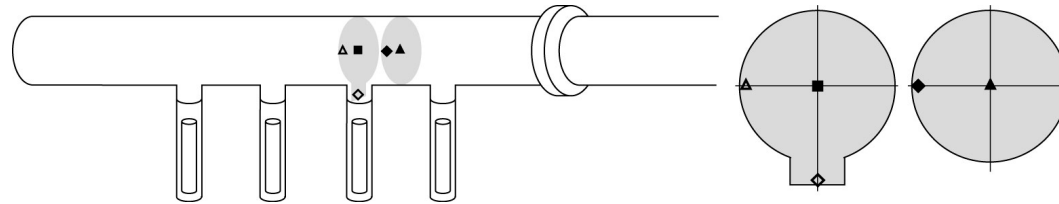
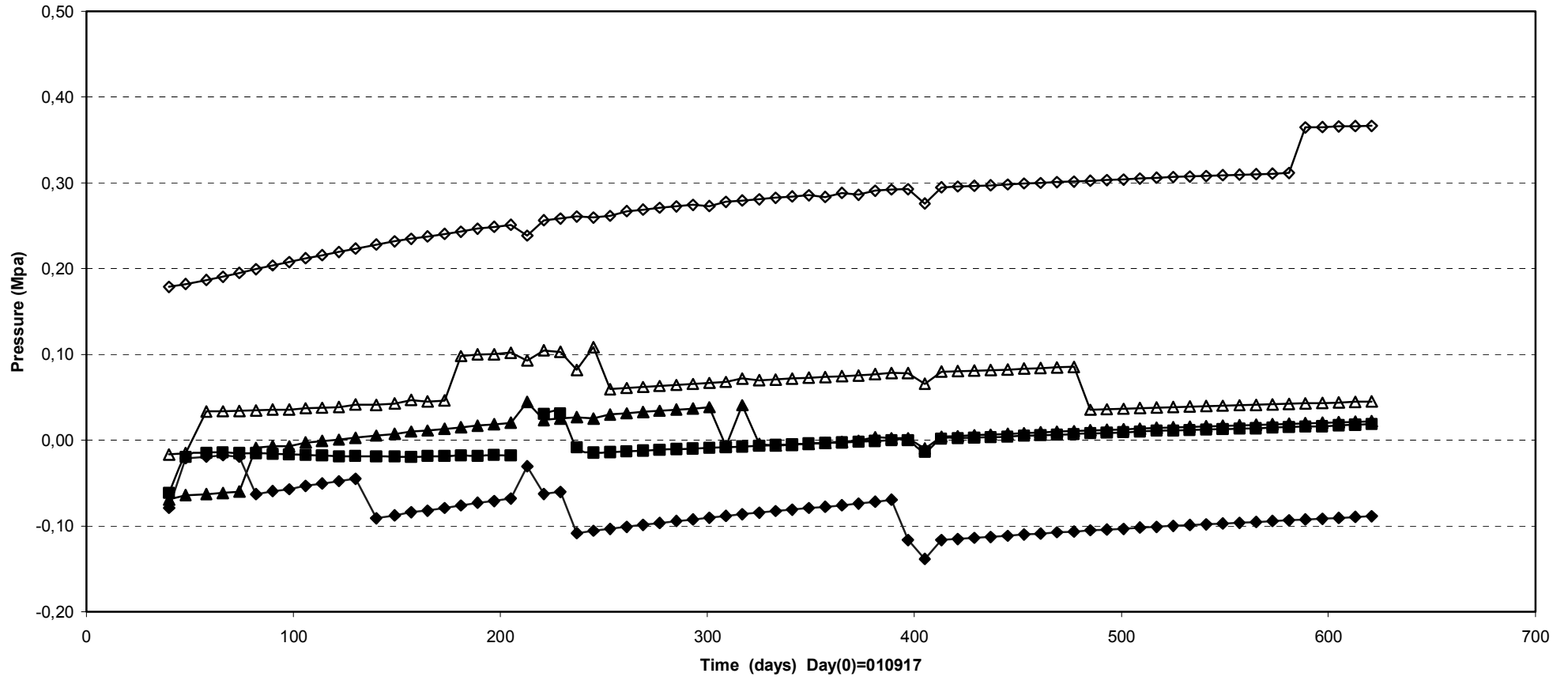

◆ PBA10015(E3\0\3.1\3575)
▲ PBA10016(E3\2.3\0\3575)
■ PBA10017(E3\0\0\3574)
▲ PBA10018(F3-4\0\0\3572)
◆ PBA10019(F3-4\0\2.3\3572)

PrototypeBaFil (010917-030601)
 Total pressure - Kulite

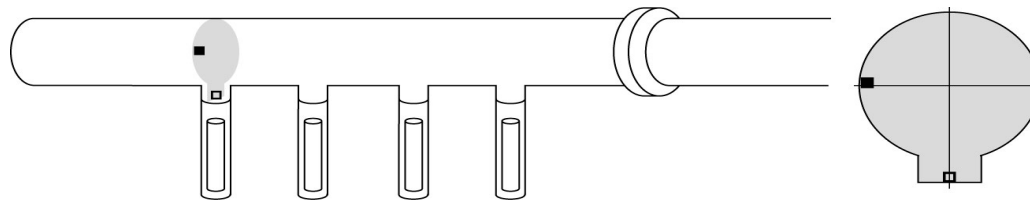
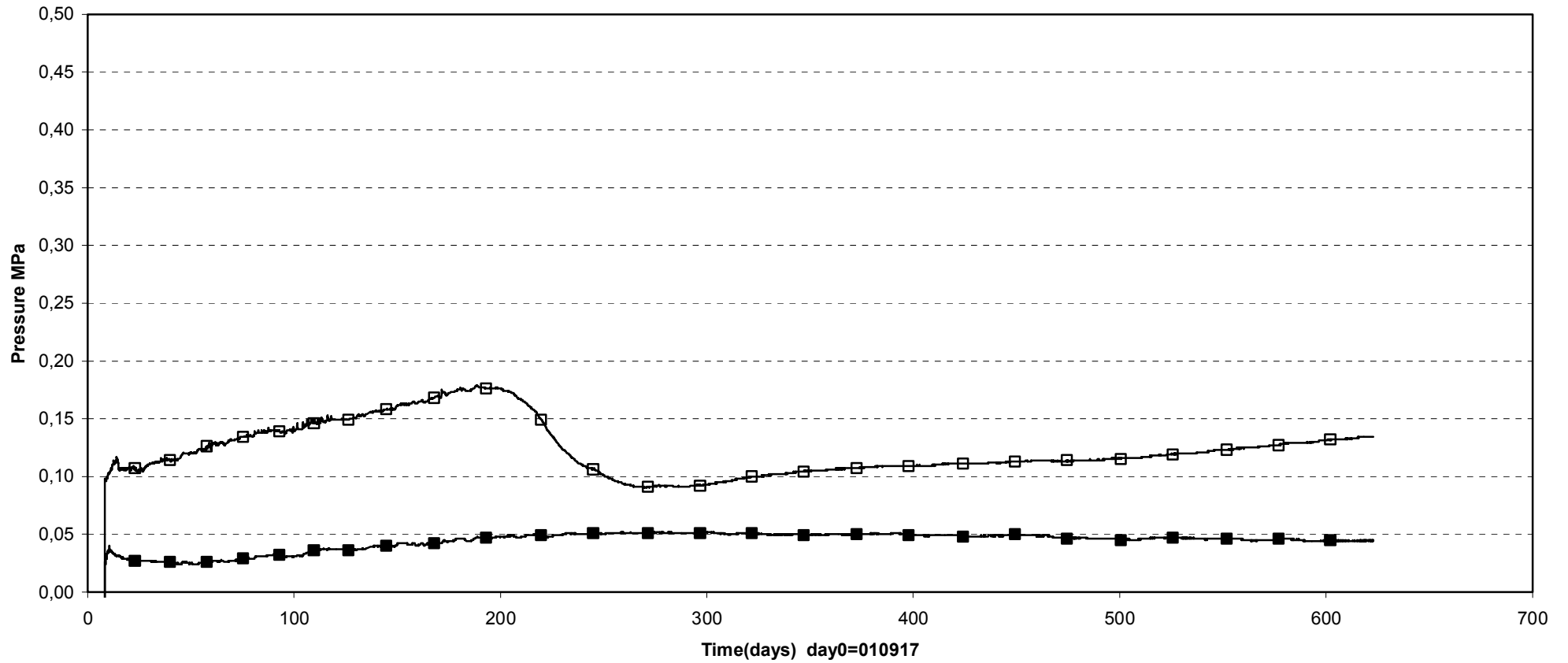

□ PBA10005(E1\0-3.1\3587) ■ PBA10006(E1\ -2.3\0.1\3587)

Prototype\BaFil (010917-030601)
Total pressure - Kulite

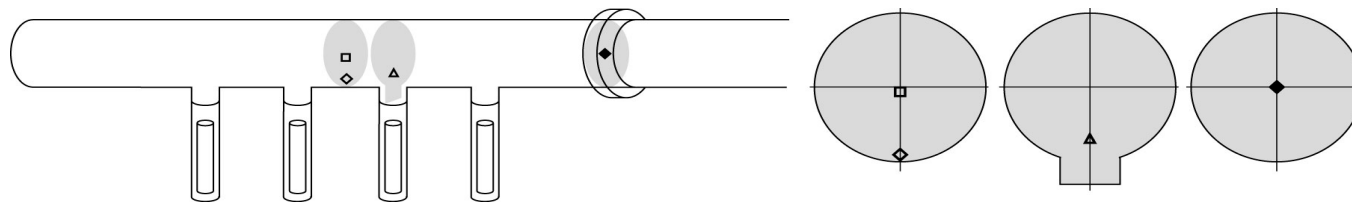
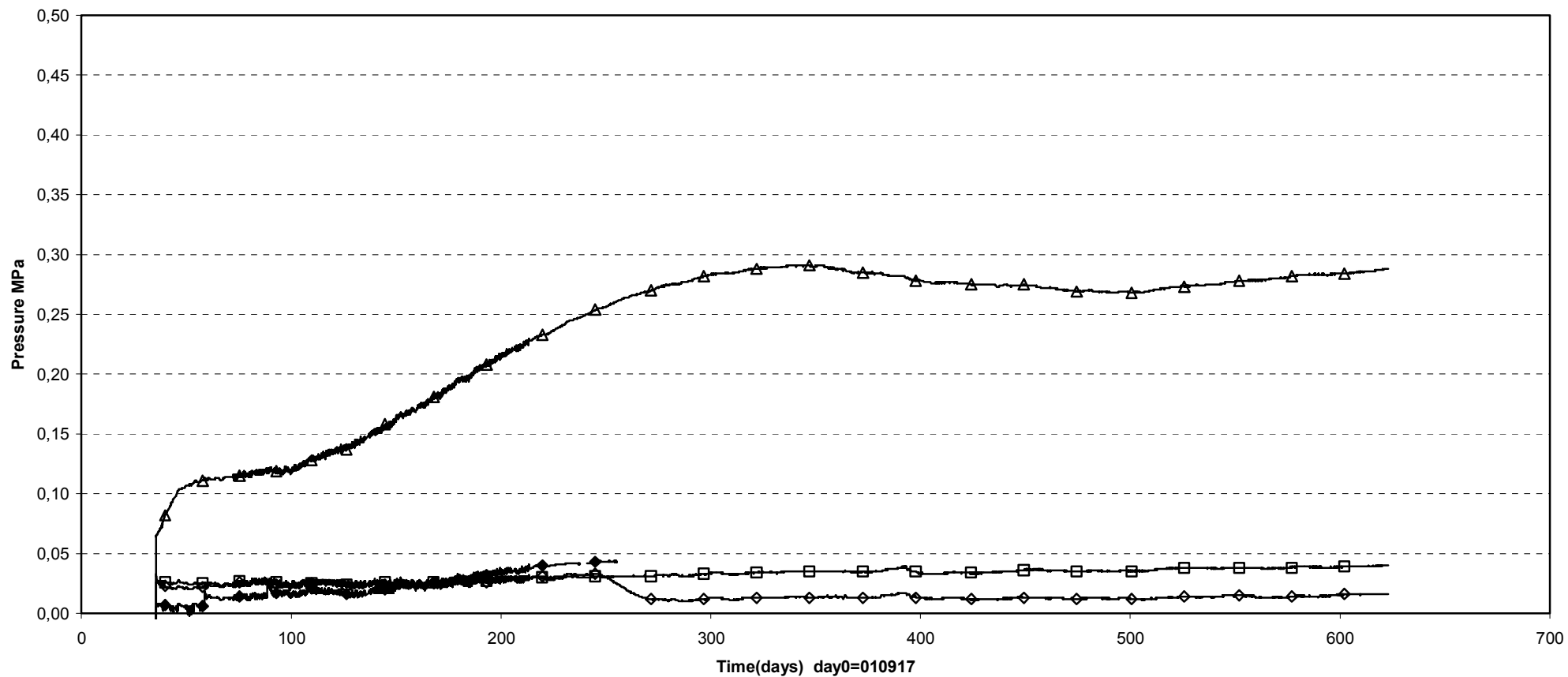

□ PBA10010(F1-2\0\0-0.2\3578) ◇ PBA10011(F1-2\0\0-2.3\3578) △ PBA10013(E3\0\0-1.82\3575) ◆ PBA10020(In front of plug\0\0\3561)

Prototype\Backfill \ Inner part (010917-030601)
Suction - Wescor

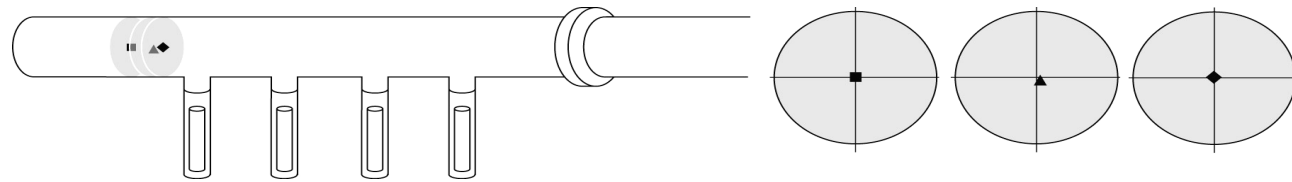
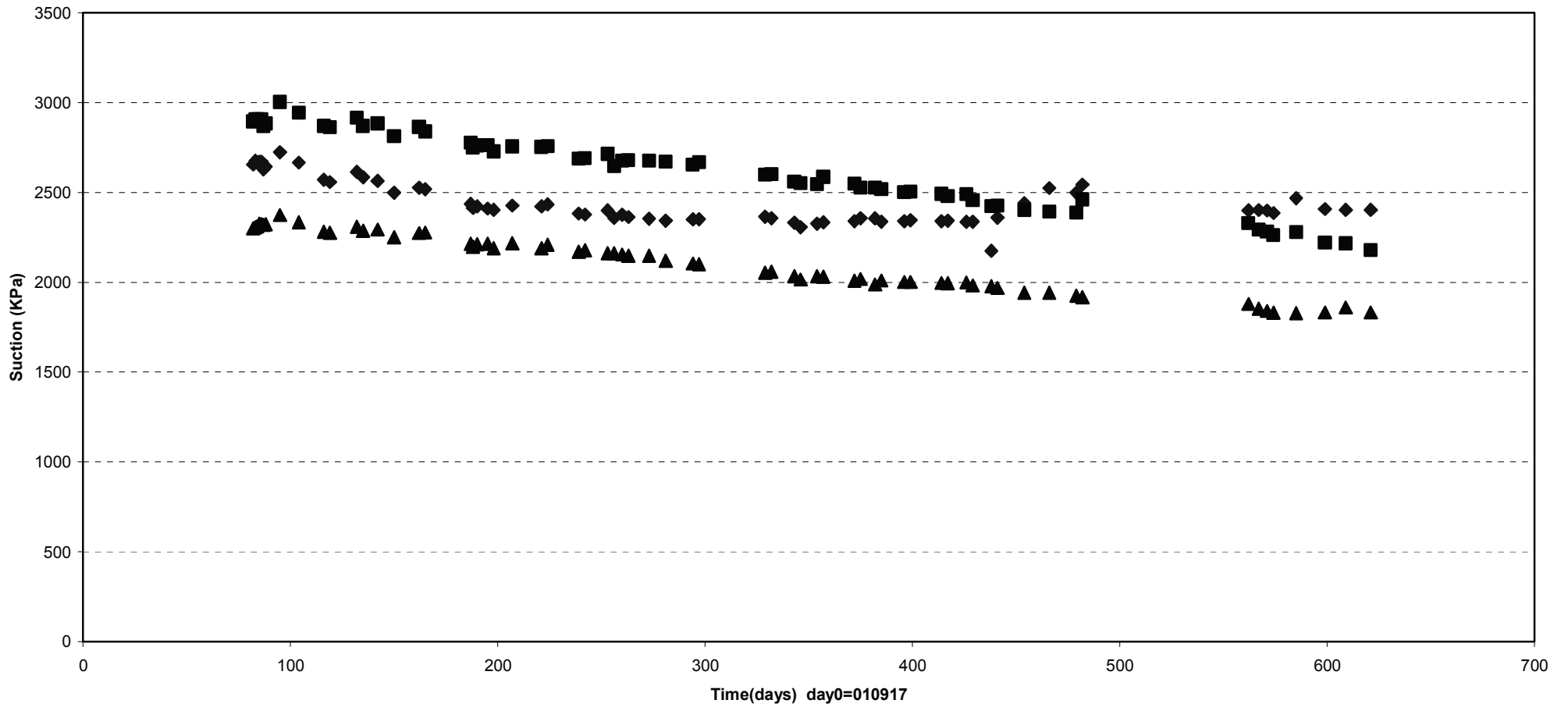

◆ WBA10001 (Inner part\0\0\3589) ■ WBA10002 (Inner part\0\0\3592) ▲ WBA10003 (Inner part\0.1\0.1\3590)

Prototype\Backfill\ Above dep.hole 1 (010917-030601)
Suction - Wescor

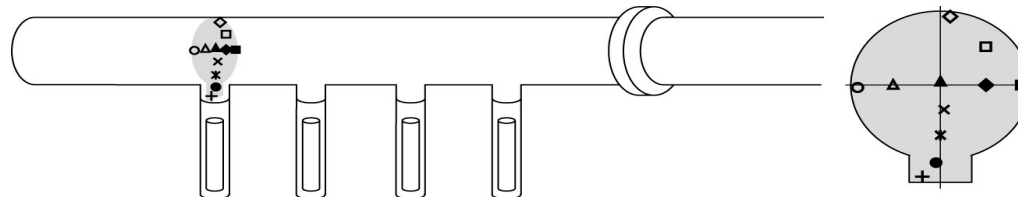
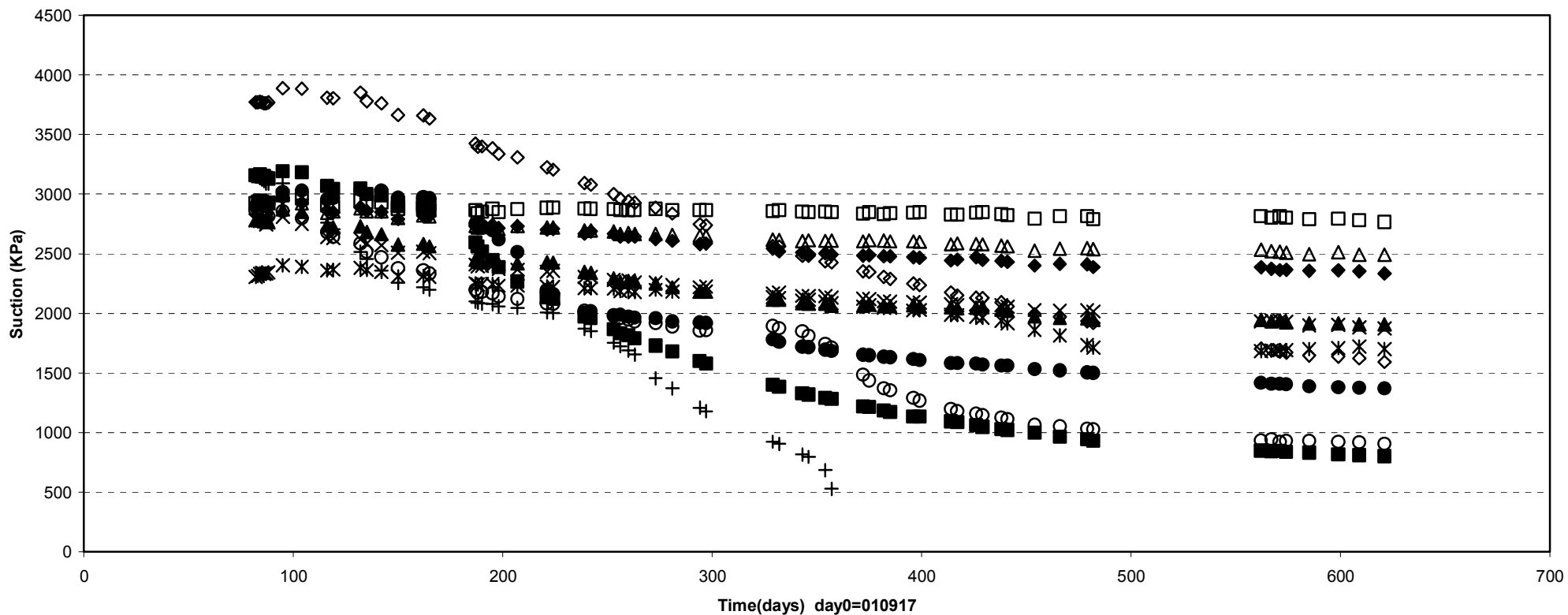

- | | | | |
|------------------------------|-----------------------------|------------------------------|-----------------------------|
| ◇ WBA10004(E1\0.25\2.3\3587) | □ WBA10005(E1\0\1.25\3587) | ▲ WBA10006(E1\0\0.1\3587) | × WBA10007(E1\0.1\0.8\3587) |
| ✱ WBA10008(E1\0\1.7\3587) | ● WBA10009(E1\0.1\2.6\3587) | + WBA10010(E1\0.5\3.13\3587) | ○ WBA10011(E1\2.3\0.1\3587) |
| △ WBA10012(E1\1.3\0\3587) | ◆ WBA10013(E1\1.3\0\3587) | ■ WBA10014(E1\2.3\0\3587) | |

Prototype\Backfill \ Between dep.hole 1 and hole 2 (010917-030601)
 Suction - Wescor

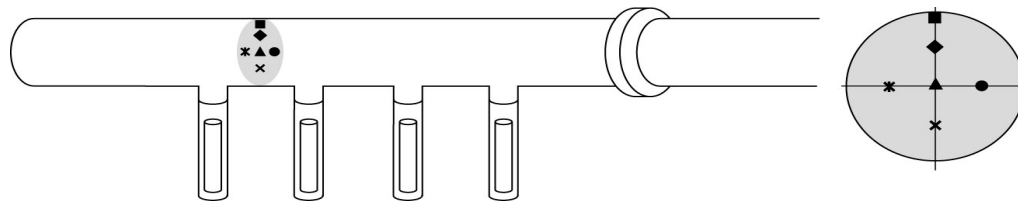
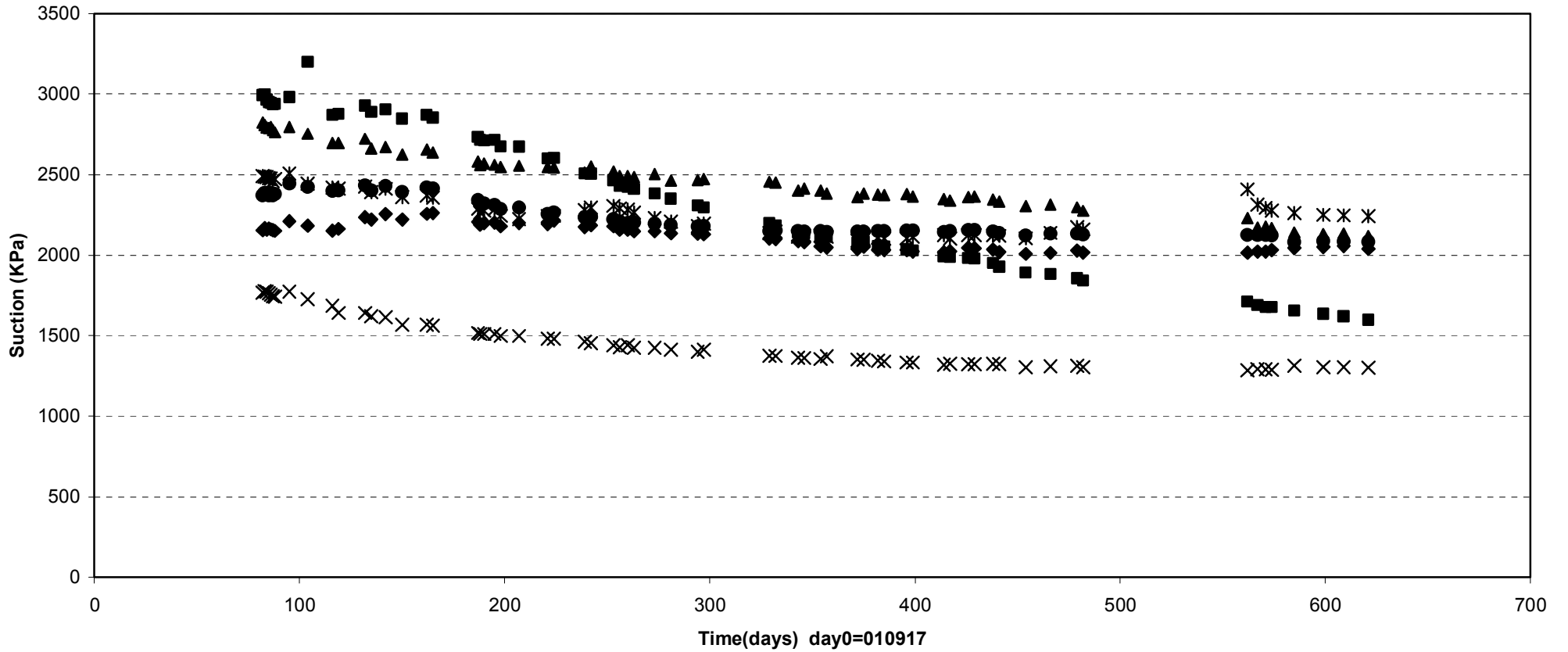

- ◆ WBA10015(F1-2\0\1.3\3584) ■ WBA10016(F1-2\0\2.3\3584) ▲ WBA10017(F1-2\0\0\3584) × WBA10018(F1-2\0\1.3\3584)
- ✱ WBA10019(F1-2\1.3\0\3584) ● WBA10020(F1-2\1.3\0\3584)

Prototype\Backfill \ Between dep.hole 2 and hole 3 (010917-030601)
Suction - Wescor

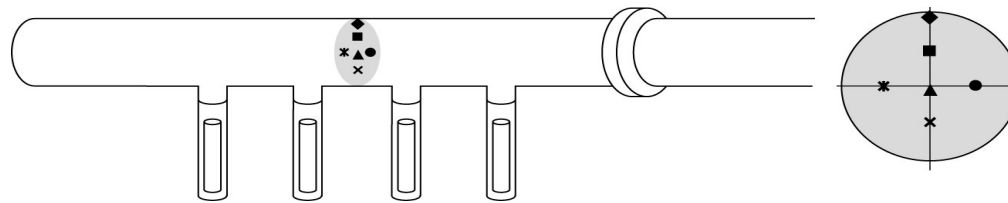
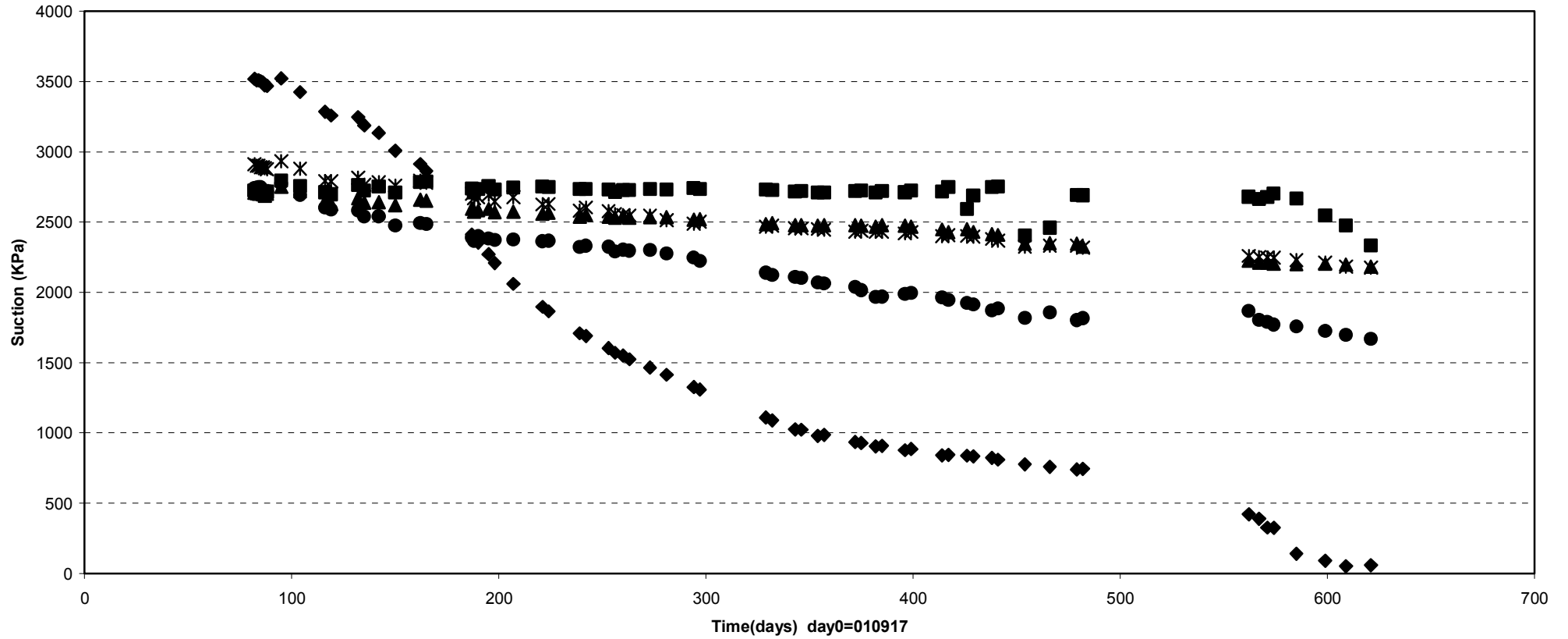

◆ WBA10021(F2-3\0\2.3\3578) ■ WBA10022(F2-3\0\1.2\3578) ▲ WBA10023(F2-3\0\0.2\3578) ✱ WBA10025(F2-3\0\1.3\0\3578) ● WBA10026(F2-3\1.3\0\3578)

Prototype\Backfill\ Above dep.hole 3 (010917-030601)
Suction - Wescor

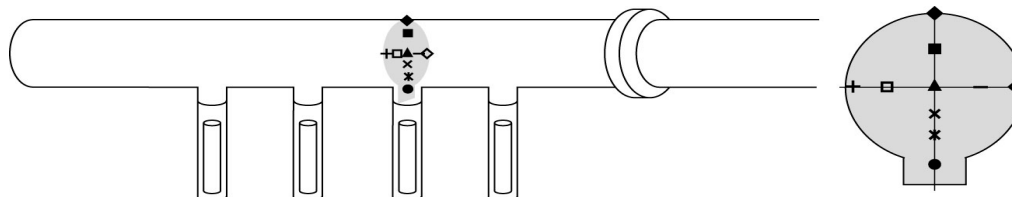
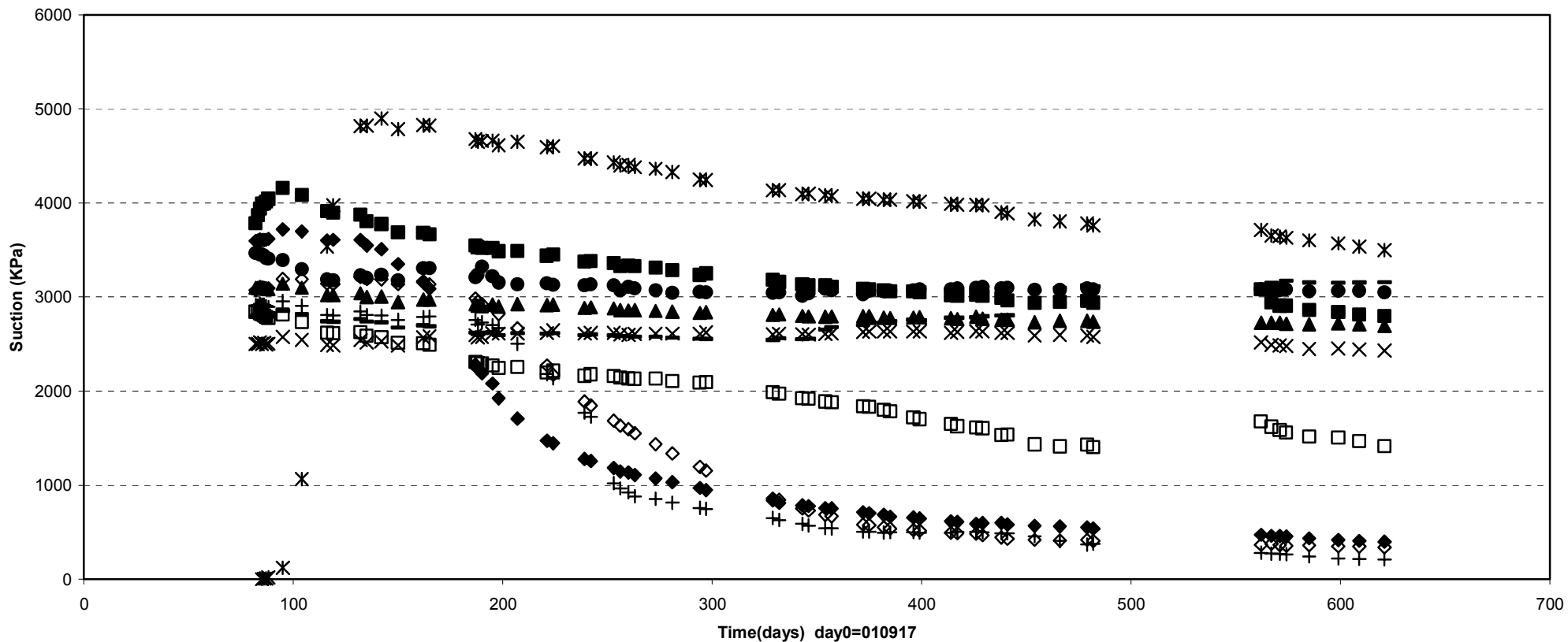

- | | | | | |
|-------------------------------|-----------------------------|-----------------------------|-----------------------------|-----------------------------|
| ◆ WBA10027(E3\0\2.5\3574) | ■ WBA10028(E3\0\1.3\3575) | ▲ WBA10029(E3\0\0\3575) | × WBA10030(E3\0\0-0.9\3575) | ✱ WBA10031(E3\0\1-1.6\3575) |
| ● WBA10032(E3\0-0.3\2.6\3575) | + WBA10034(E3\0-2.3\0\3575) | □ WBA10035(E3\0-1.3\0\3575) | - WBA10036(E3\1.3\0\3575) | ◇ WBA10037(E3\2.3\0\3575) |

Prototype\Backfill \ Between dep.hole 3 and hole 4 (010917-030601)
Suction - Wescor

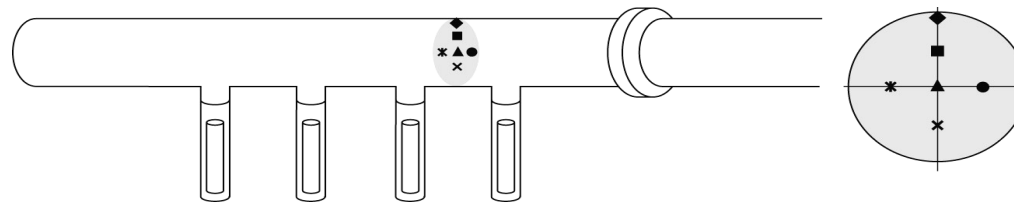
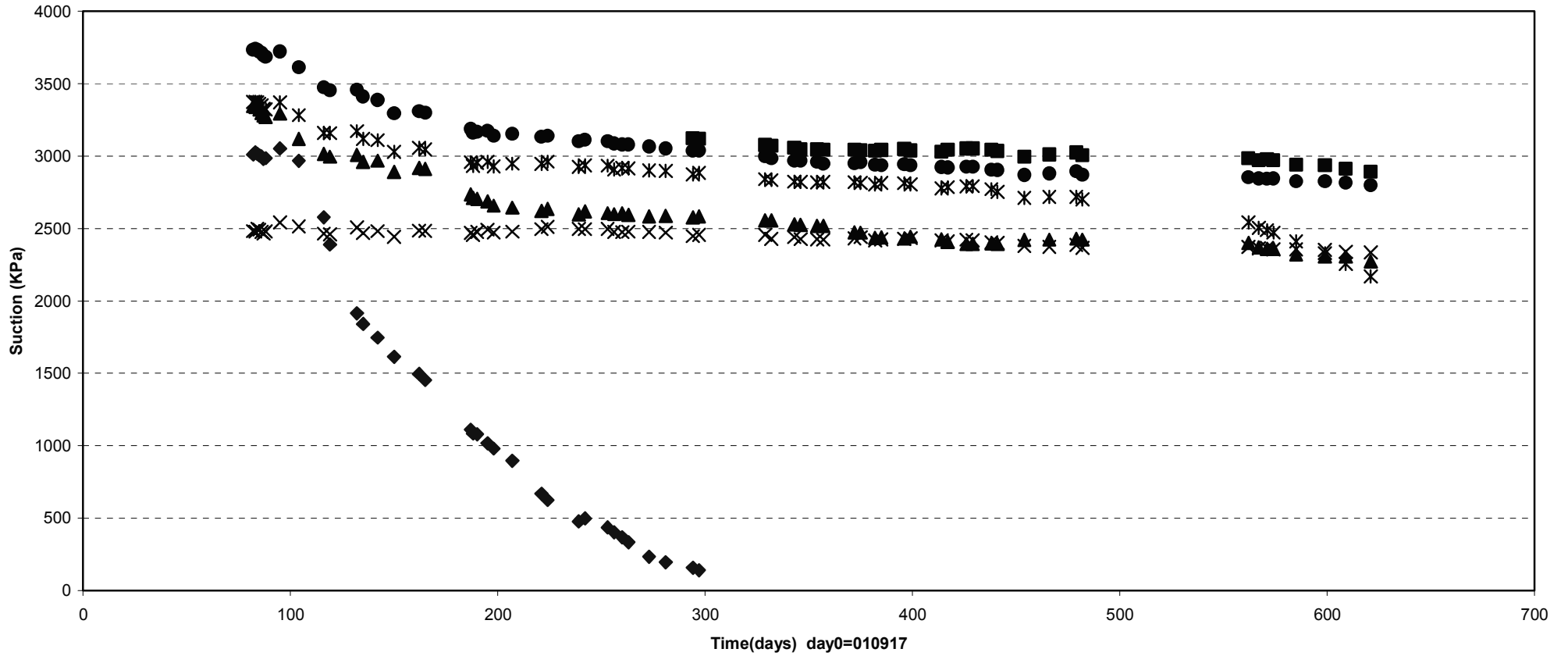

- | | | | |
|------------------------------|------------------------------|----------------------------|------------------------------|
| ◆ WBA10038(F3- 4\0\2.3\3572) | ■ WBA10039(F3- 4\0\1.2\3572) | ▲ WBA10040(F3- 4\0\0\3572) | × WBA10041(F3- 4\0\1.3\3572) |
| ✱ WBA10042(F3- 4\1.3\0\3572) | ● WBA10043(F3- 4\1.3\0\3572) | | |

Prototype\Backfill \ In front of plug (010917-030601)
Suction - Wescor

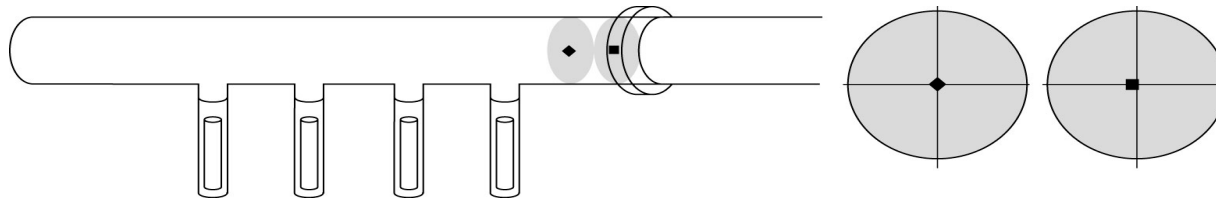
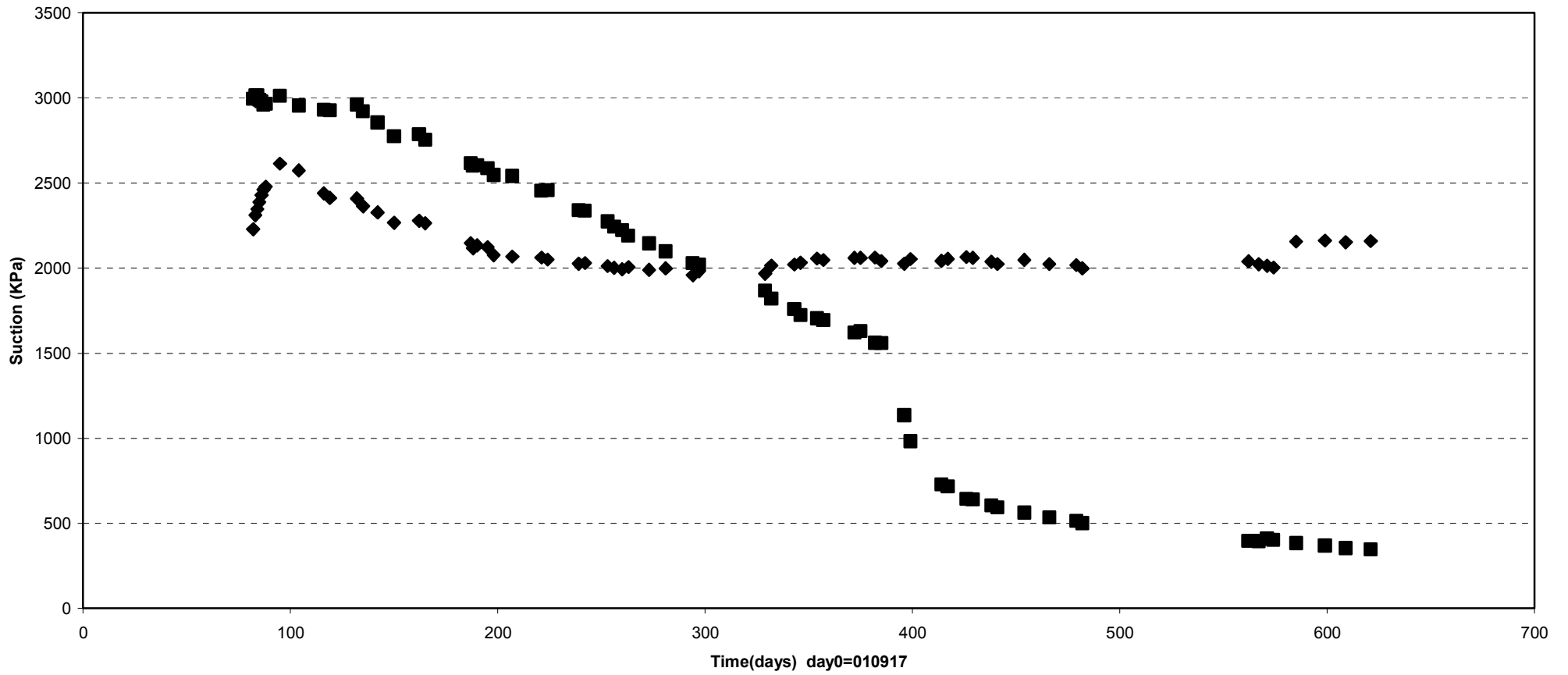

◆ WBA10044(In front of plug\0\0\3565) ■ WBA10045(In front of plug\-.1\0\3562)

Prototype\Backfill (010917-030601)
Pore pressure - Geokon

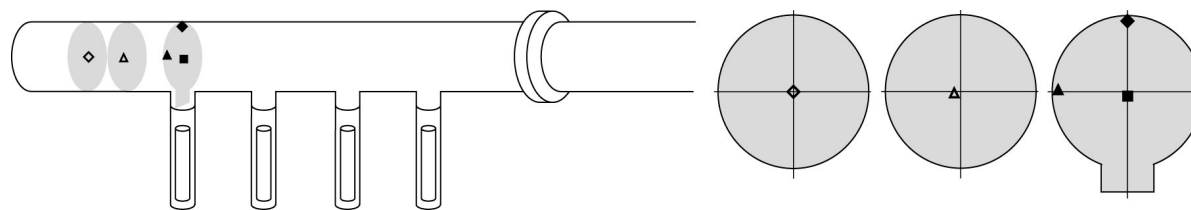
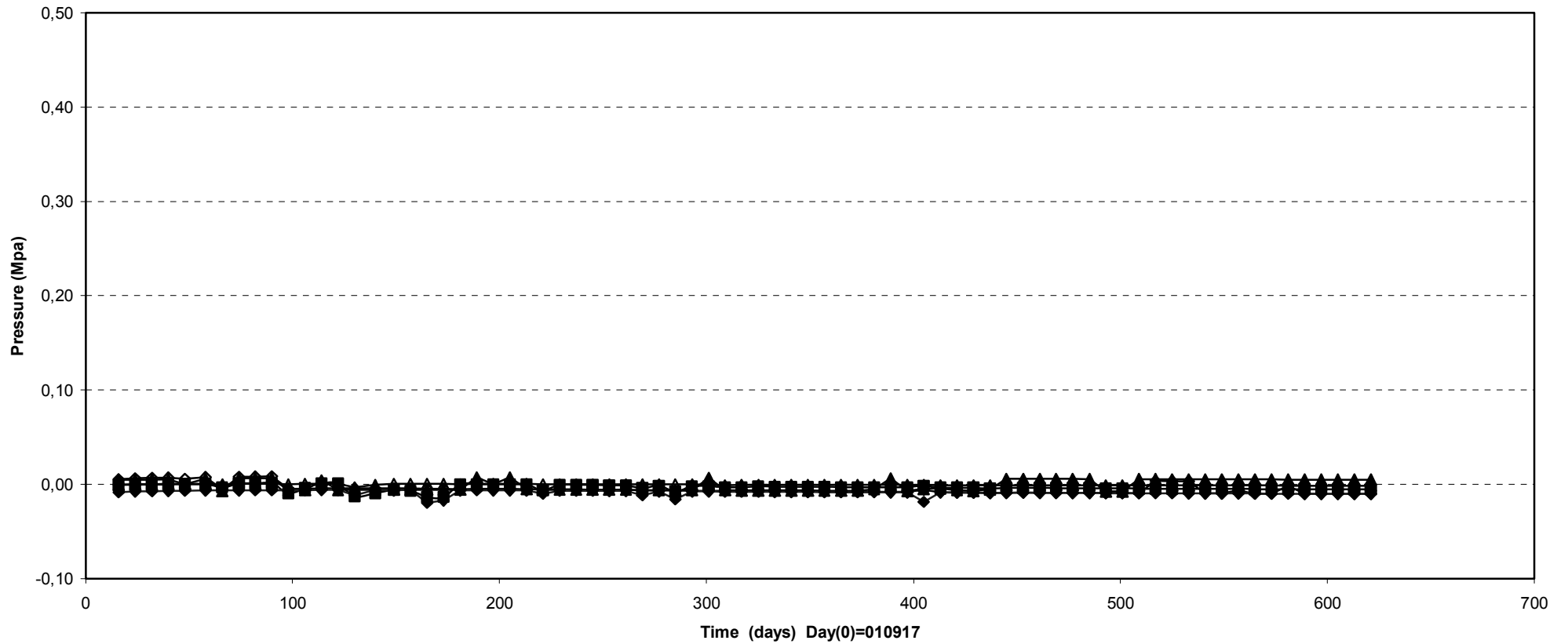

—◇— UBA10002(Inner part\0\0\3592)	—△— UBA10003(Inner part\0.2\0.1\3590)	—■— UBA10004(E1\0\0\3587)
—▲— UBA10008(E1\2.3\0\3587)	—◆— UBA10009(E1\0\2.3\3587)	

Prototype\Backfill (010917-030601)
Pore pressure - Geokon

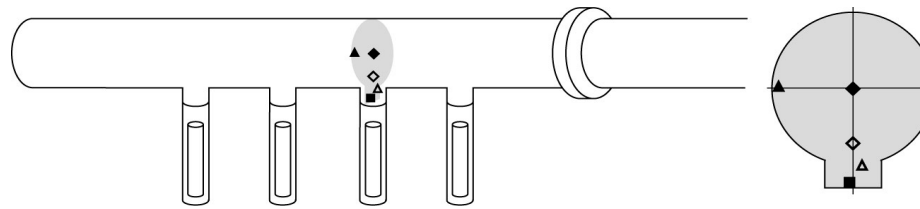
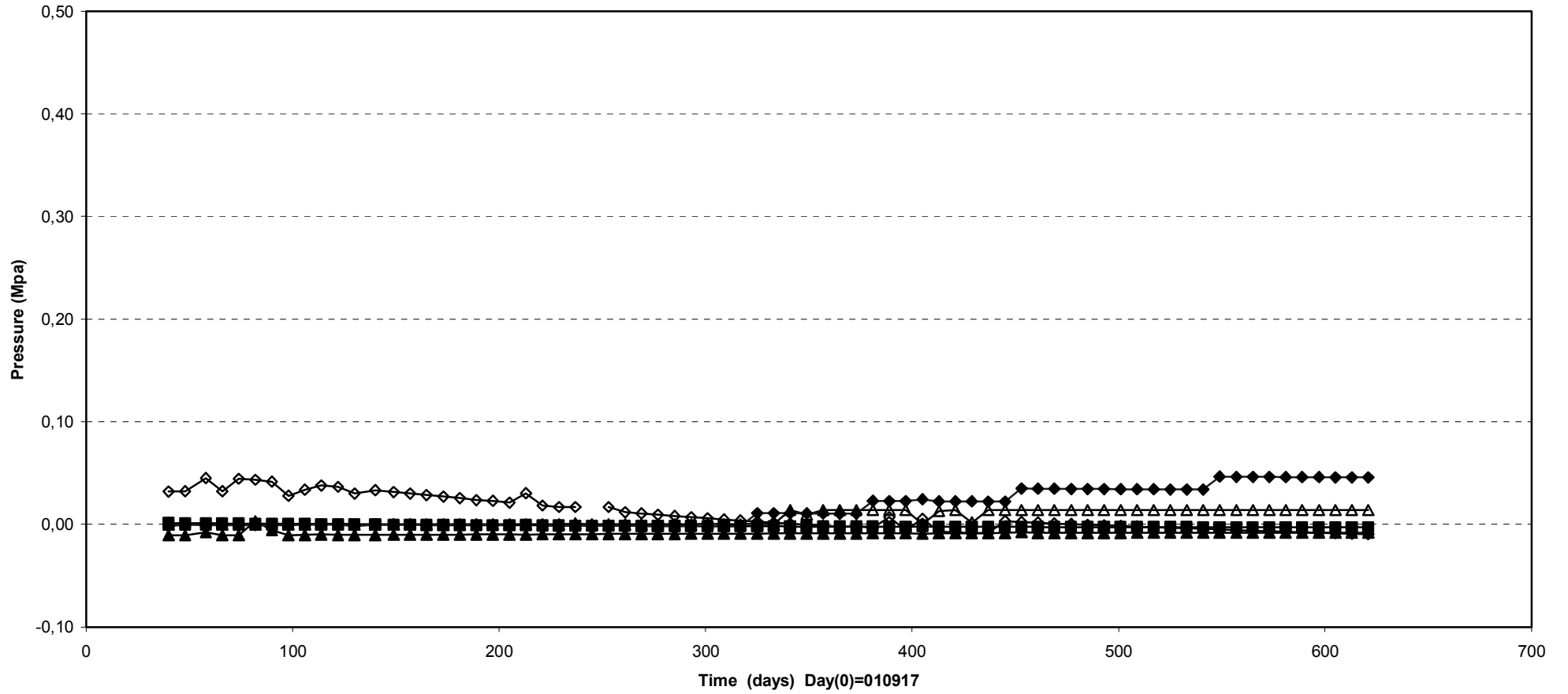

UBA10015(E3\0\ -1.82\3575)
 UBA10016(E3\0.25\ -2.6\3575)
 UBA10017(E3\ -0.1\ -3.1\3575)
 UBA10018(E3\ -2.3\0\3575)
 UBA10019(E3\0\0\3574)

Prototype\BaFil (010917-030601)
 Pore pressure - Kulite

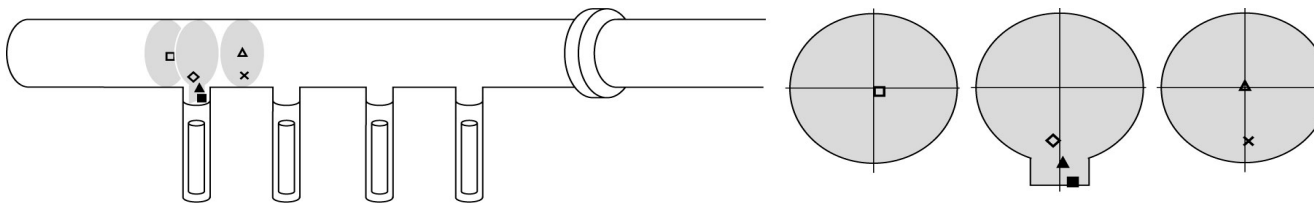
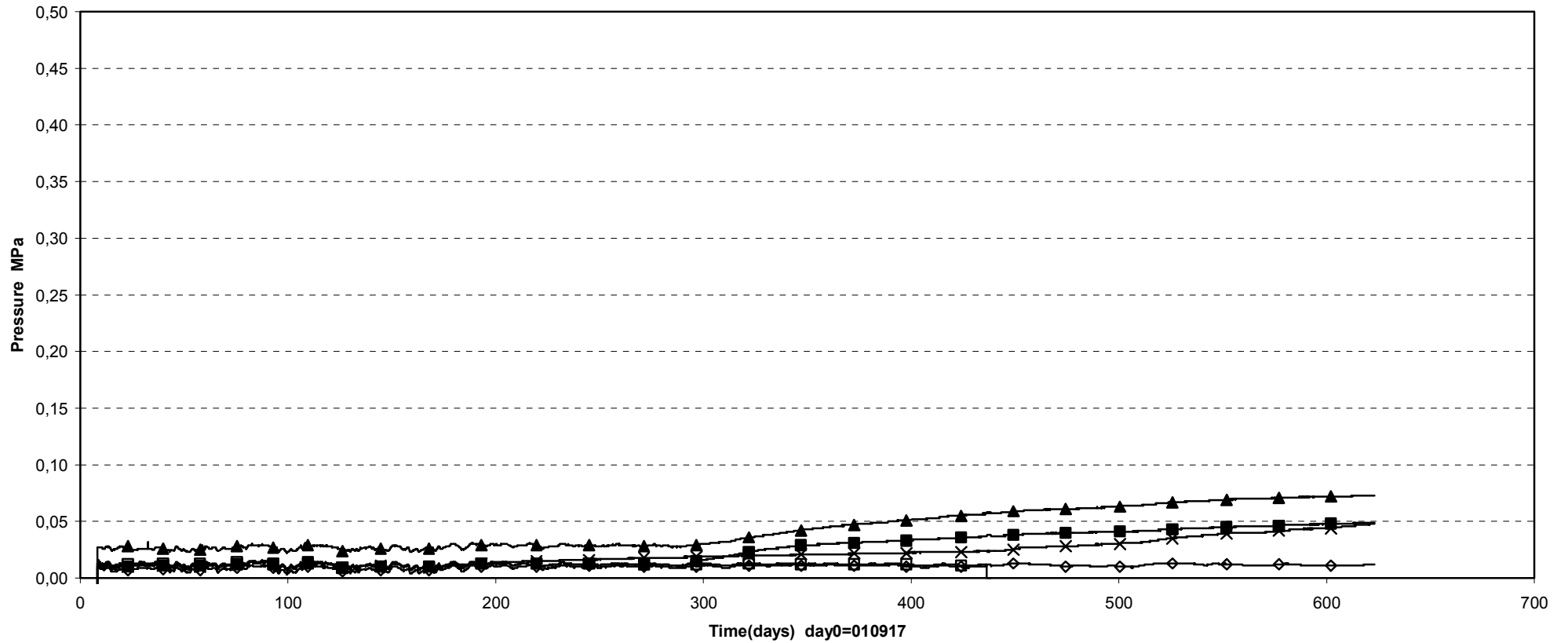

- | | | |
|--------------------------------------|------------------------------|--------------------------------|
| □ UBA10001 (Inner part\0.2\0.1\3589) | ◇ UBA10005 (E1\0.2\1.8\3587) | ▲ UBA10006 (E1\0.1\2.6\3587) |
| ■ UBA10007 (E1\0.4\3.2\3587) | △ UBA10010 (F1-2\0\3584) | × UBA10011 (F1-2\0.1\1.2\3584) |

PrototypeBaFil (010917-030601)
Pore pressure - Kulite

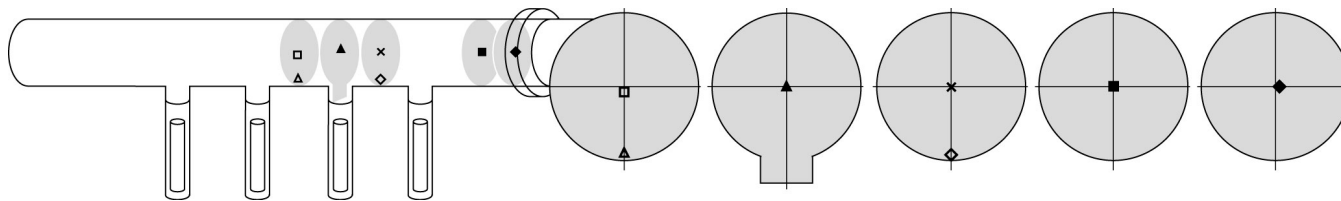
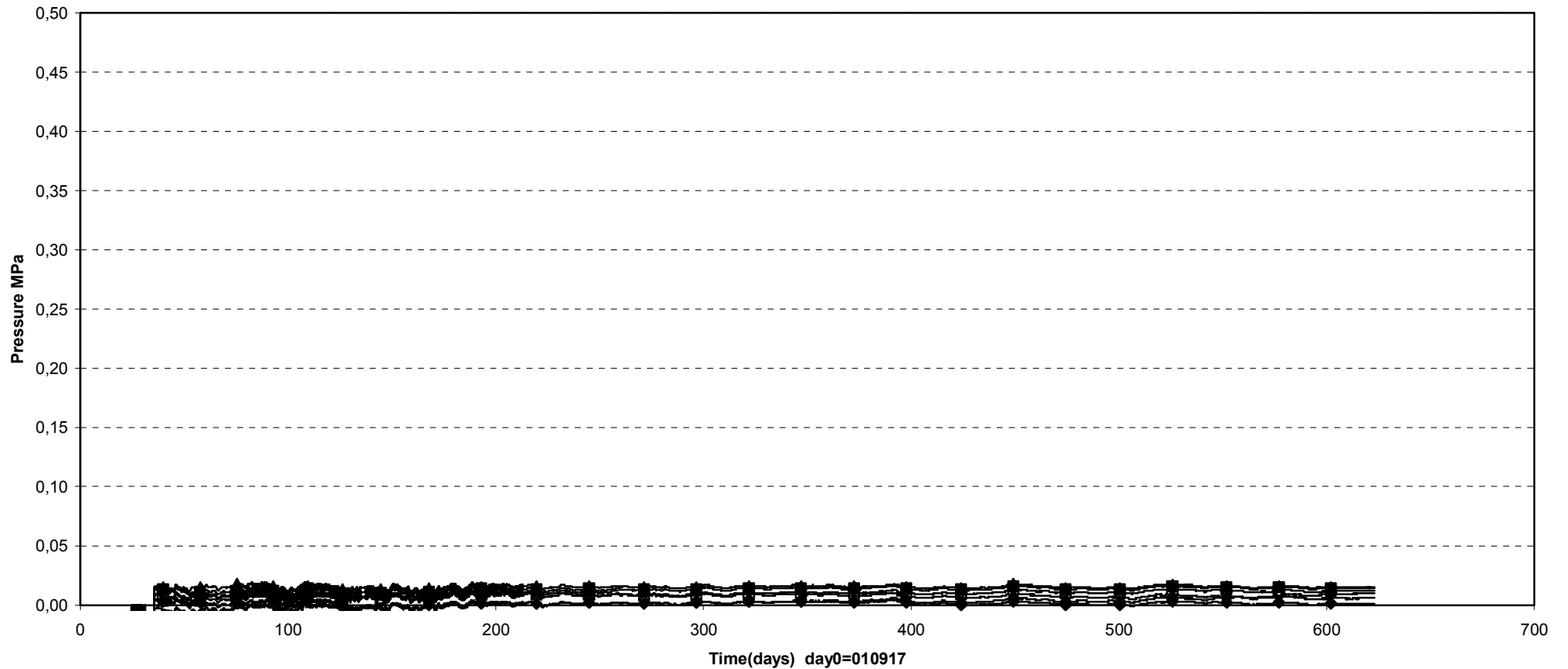

□ UBA10012(F2-3\0\0.2\3578)	△ UBA10013(F2-3\0\0.2\3578)	▲ UBA10014(E3\0\0\3575)	× UBA10020(F3-4\0\0\3572)
◇ UBA10021(F3-4\0\0.2\3572)	■ UBA10022(In front of plug\0\0\3565)	◆ UBA10023(In front of plug\0.1\0\3561)	

Prototype\ Backfill \ Above dep.hole1 (010917-030601)
 Temperature - Pentronic

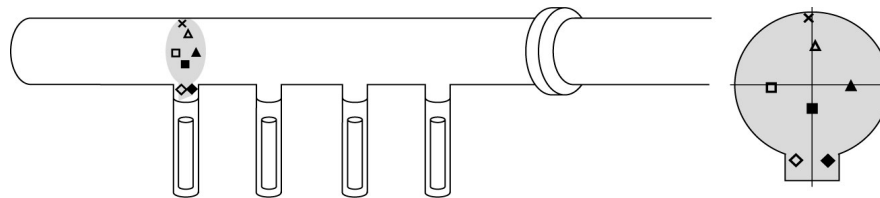
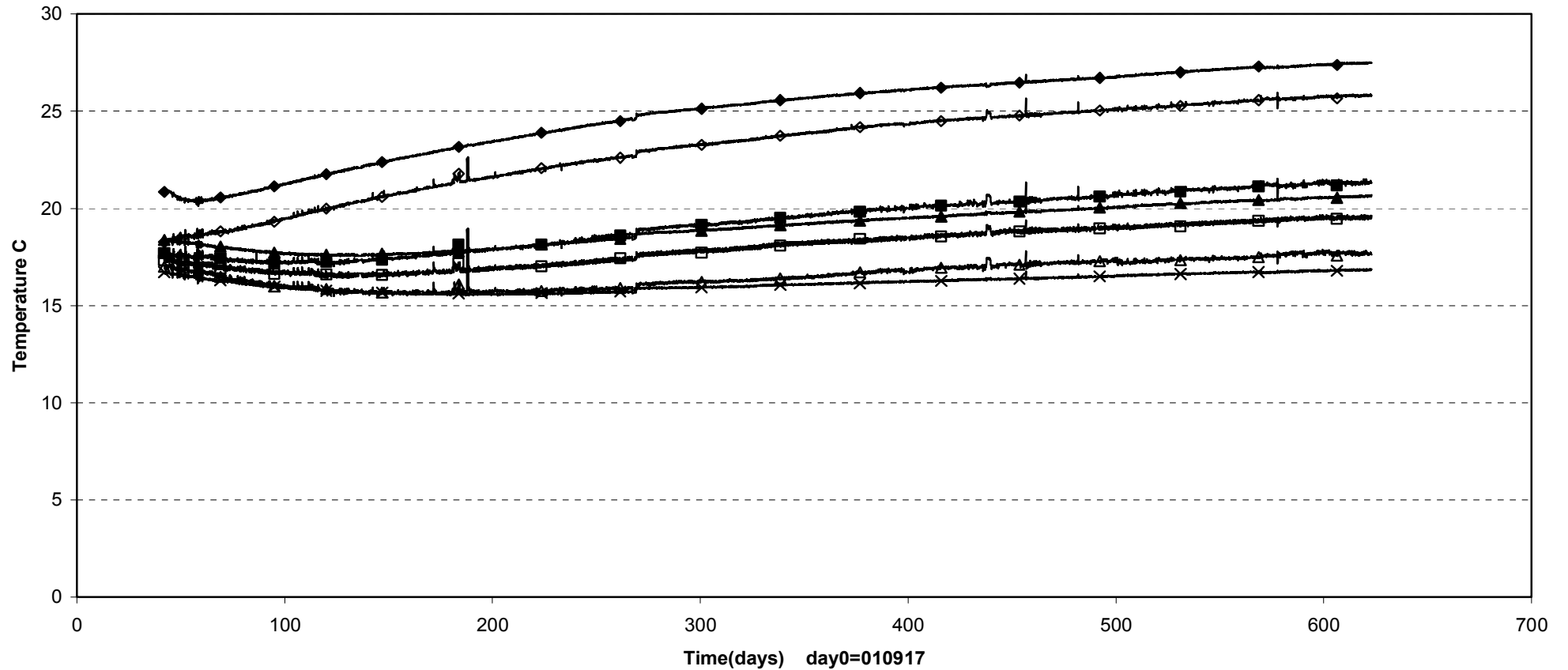

- | | | | |
|------------------------------|------------------------------|------------------------------|-----------------------------|
| □ TBA10001(E1\1.25\0.1\3587) | △ TBA10002(E1\0.1\1.3\3587) | ■ TBA10003(E1\0\0.8\3587) | ◇ TBA10004(E1\0.5\2.6\3587) |
| ◆ TBA10005(E1\0.5\2.6\3587) | × TBA10006(E1\0.12\2.3\3587) | ▲ TBA10007(E1\1.25\0.1\3587) | |

Prototype\ Backfill \ Between dep.hole 1-2 (010917-030601)
 Temperature - Pentronic

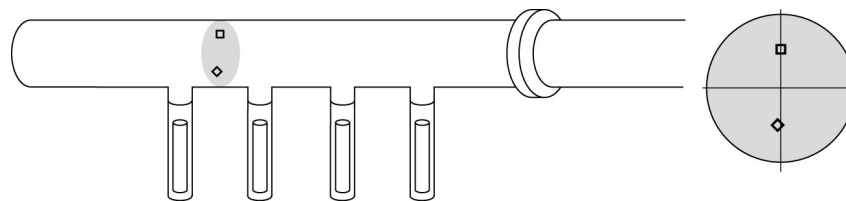
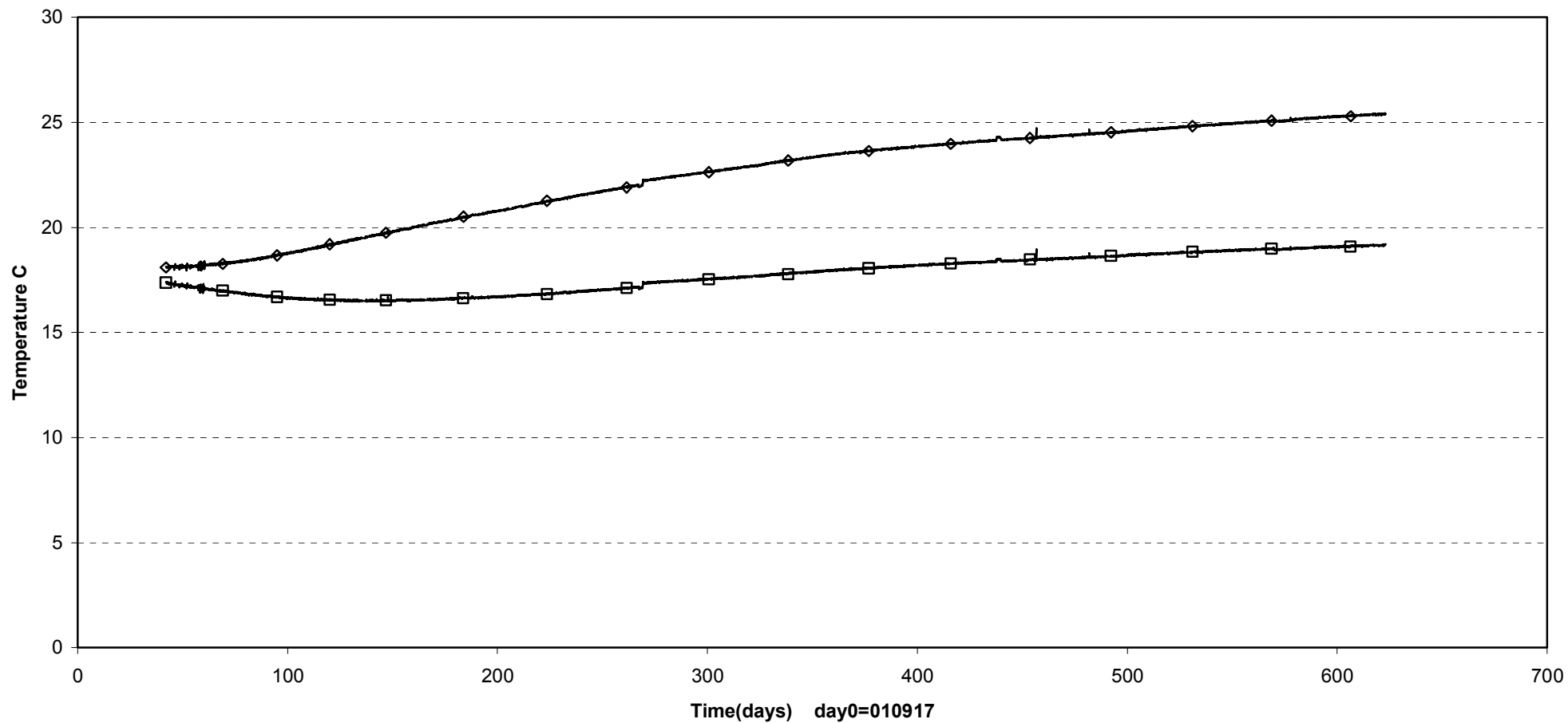

□ TBA10008(F1-2\0\1.25\3584) ◇ TBA10009(F1-2\0.1\1.3\3584)

Prototype \ Backfill \ Between dep.hole 2-3 (010917-030601)
Temperature -Pentronic

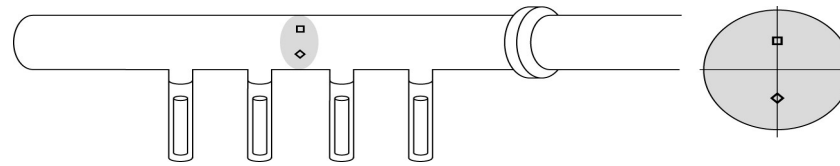
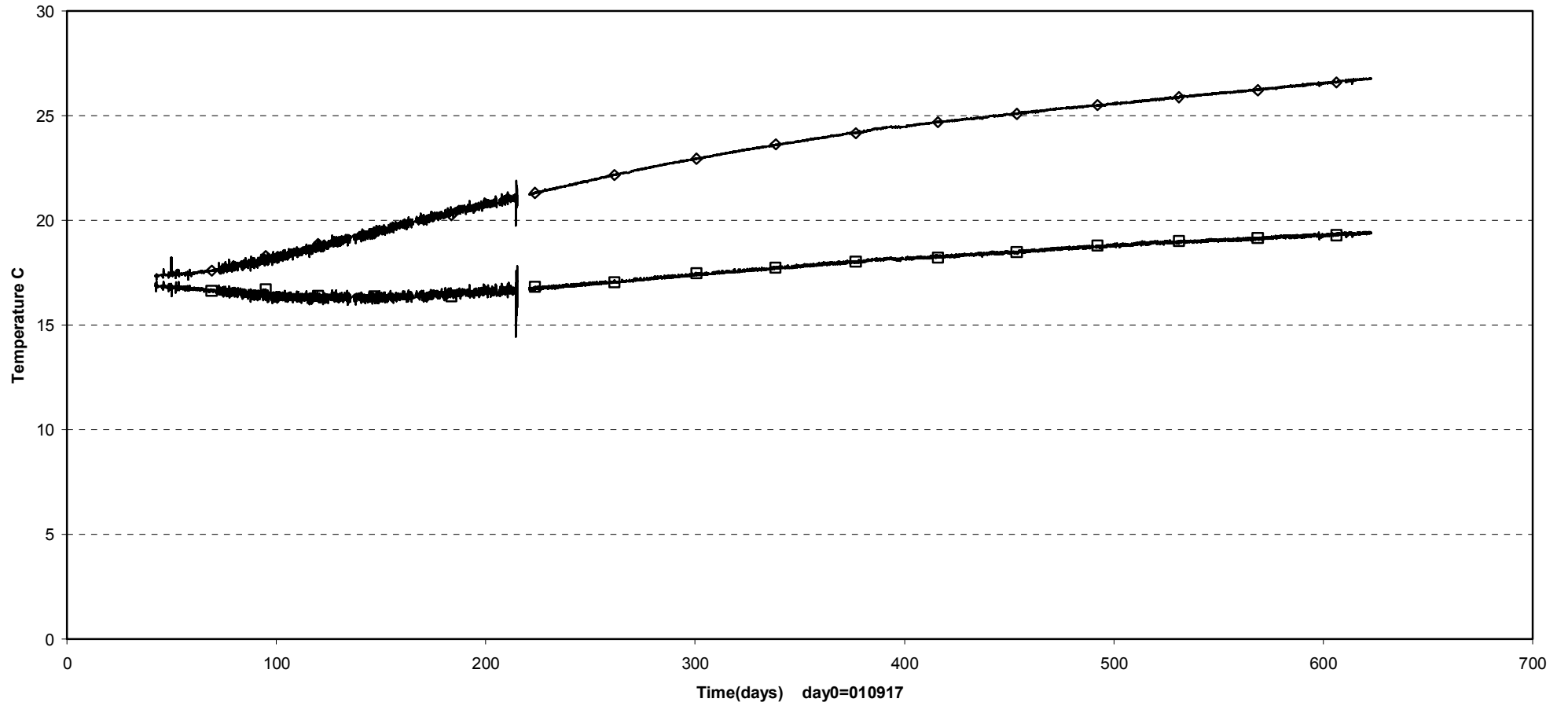

□ TBA10010(F2-3\0\1.15\3578) ◇ TBA10011(F2-3\0\1.24\3578)

Prototype\ Backfill \ Above dep.hole3 (010917-030601)
 Temperature - Pentronic

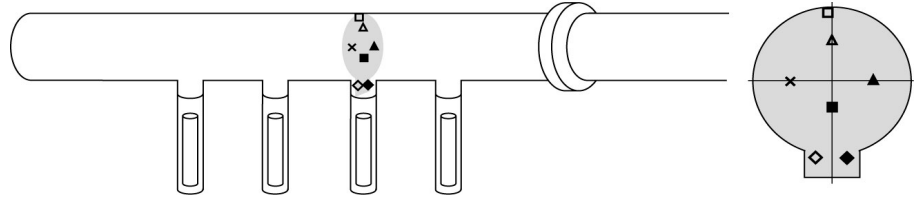
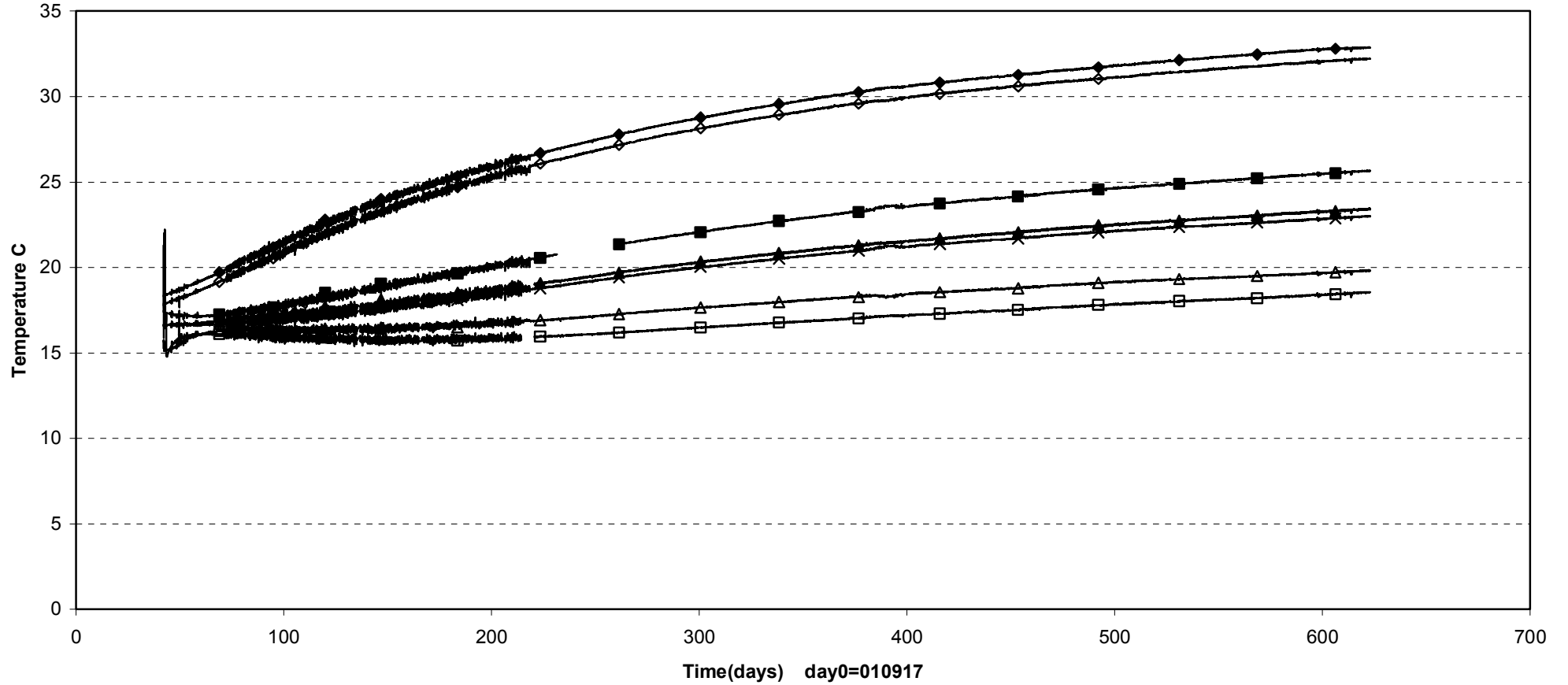

- TBA10012(E3\0.1\2.3\3575) △ TBA10013(E3\0\1.3\3575) ■ TBA10014(E3\0\0.9\3575) ◇ TBA10015(E3\0.5\2.6\3575)
- ◆ TBA10016(E3\0.5\2.6\3575) × TBA10017(E3\1.3\0\3575) ▲ TBA10018(E3\1.3\0\3575)

Prototype\ Backfill \ Between dep.hole 3-4 (010917-030601)
Temperature - Pentronic

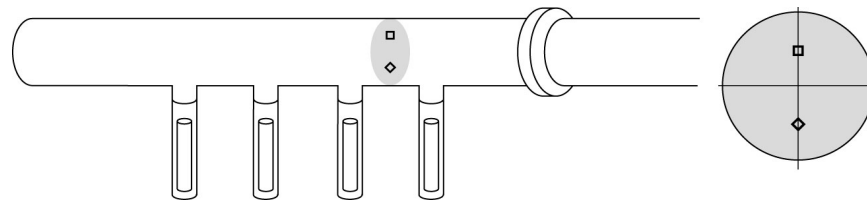
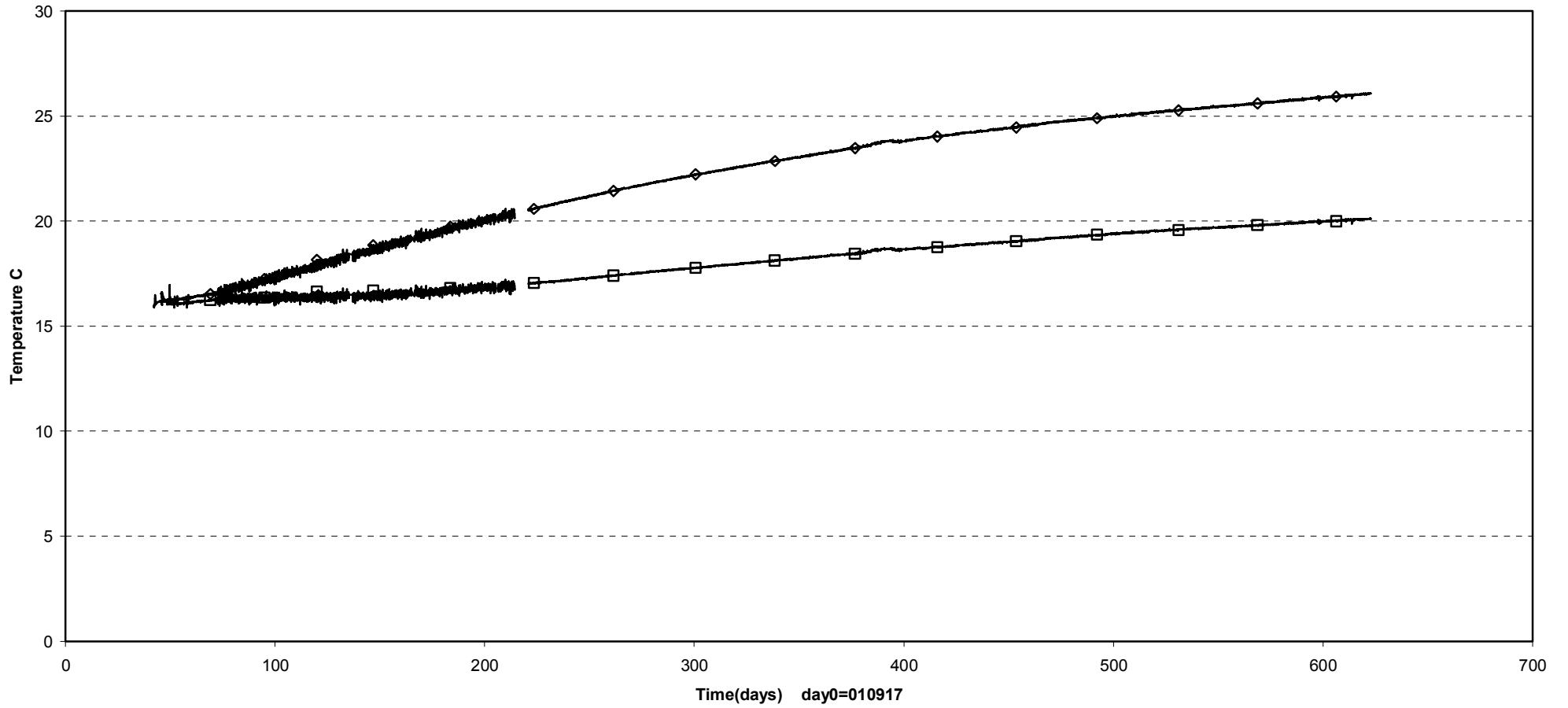

□ TBA10019(F3-4\0\1.2\3572) ◇ TBA10020(F3-4\0\1.3\3572)

Appendix 5

Canister displacements

Barcena, I. and García-Siñeriz, J.L., AITEMIN

Canister displacements

The measurements of canister displacements are made by AITEMIN. The technique is described in the report:

Bárcena, I., García-Siñeriz, J.L. (2001) Prototype Repository. System for canister displacement tracking.

Layout

The measurements in section 1 are made on the canister in deposition hole 3. For this deposition hole, six displacement sensors have been installed, all grouped into one measuring section, placed at the bottom of the canister, as shown in Figure 1. Three of those sensors, named MCA30001 to MCA30003 have been vertically placed into holes drilled into the bentonite block. These three sensors determine the vertical displacement of the canister, as well as any possible tilt. The points where the sensors are attached to the canister are the same as for the horizontal sensors. Figure 2 illustrates the position of the six sensors for deposition hole No. 3.

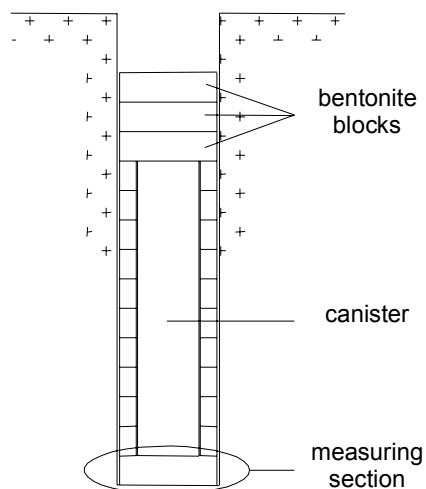

Figure 1. Location of measuring section in the deposition hole

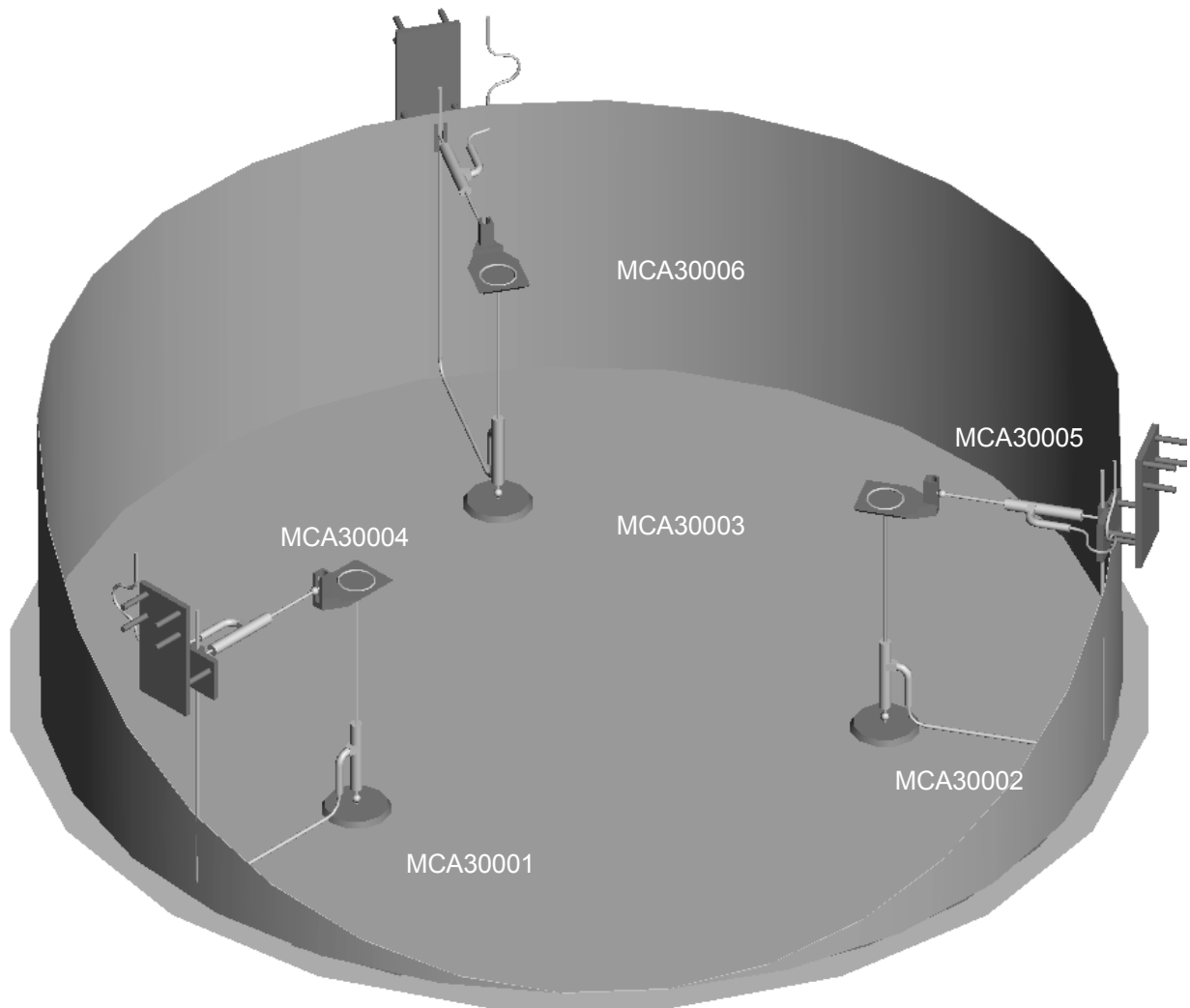

Figure 2. General view of sensors in deposition hole No. 3

The other three displacement sensors, named MCA30004 to MCA30006 are placed horizontally at the top of the lower bentonite block, close to the lower lid of the canister and attached to it, in a 120° radial disposition. The sensors will always be in a horizontal position, so that the horizontal displacement of the canister can be measured. The sensors have been placed so as to avoid interfering with other sensors.

Results

The measured displacements are shown in Figure 3 as a function of time from 010623 to 030601. Minus corresponds to reduction in length of the transducers, which means vertical sinking (MCA30001 to MCA30003) and horizontal approaching the rock surface (MCA30004 to MCA30006). The measurements show that there was a clear continuous sinking of the canister after an initial heave. The new trend with a slow heaving that started in the last period seems to continue and increase in rate.

Displacement of canister 3 (010623-030601)

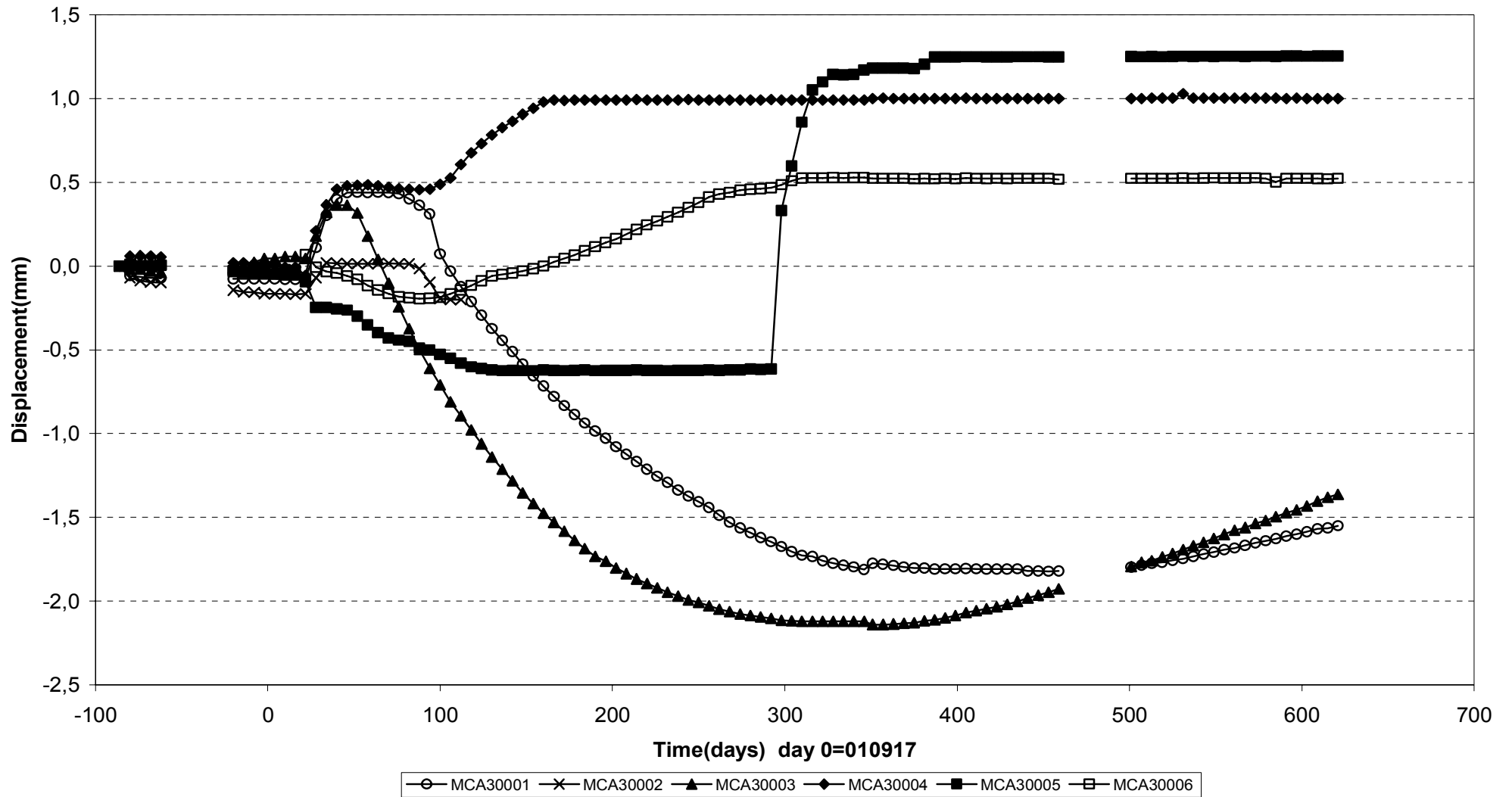

Appendix 6

Geoelectric monitoring

Rothfuchs T., GRS



Gesellschaft für Anlagen-
und Reaktorsicherheit
(GRS) mbH

Prototype Repository Project

**Data Report
Goelectric Monitoring**

Status as of 20 June 2003

Written by: ROT, WIE

Approved by: ROT

Table of Contents

1	Introduction	145
2	Backfill Section 1	147
2.1	Layout of electrode array in the backfill of section 1	147
2.2	Tomograms of the backfill array in section 1	148
2.3	Actual Interpretation	158
3	Backfill Section 2	159
4	Rock Section 2.....	161
4.1	Layout of electrode array in the rock between deposition boreholes 5 and 6.....	161
4.2	Tomograms of electrode arrays in the rock.....	162
4.3	Actual Interpretation	167
5	Buffer in Borehole 5 in Section 2.....	169
5.1	Layout of electrode array in the buffer of deposition boreholes 5	169
5.2	Tomograms of electrode array in the buffer	170
5.3	Actual Interpretation	170

1 Introduction

Within the frame of research activities in the prototype repository at Äspö GRS employs measurements of electrical resistivity to monitor water uptake in the drift backfill, the borehole buffer, and desaturation effects around one of the deposition boreholes.

The electrical resistivities in the buffer, the backfill, and around the boreholes are determined by use of multi-electrode arrays. The arrays consist of electrode chains. The resistivity distribution in the areas between the chains is determined by means of tomographic dipole-dipole measurements. The recording unit for these arrays is controlled remotely from Braunschweig / Germany through a telephone connection, which allows daily measurements of the in-situ resistivity distribution. From the measured apparent resistivity values the "true" resistivity distributions in the different parts are computed applying the latest inversion software.

In the geoelectric measurements advantage is taken of the dependence of the electrical resistivity in materials on the water (solution) content. In order to interpret the resistivity values in terms of water content the data are to be compared with laboratory calibration results which are available for the different materials.

In the following, monthly calculated inversion data for the different arrays are provided in the form of tomograms. Additional data for smaller time periods can be made available on demand.

2 Backfill Section 1

2.1 Layout of electrode array in the backfill of section 1

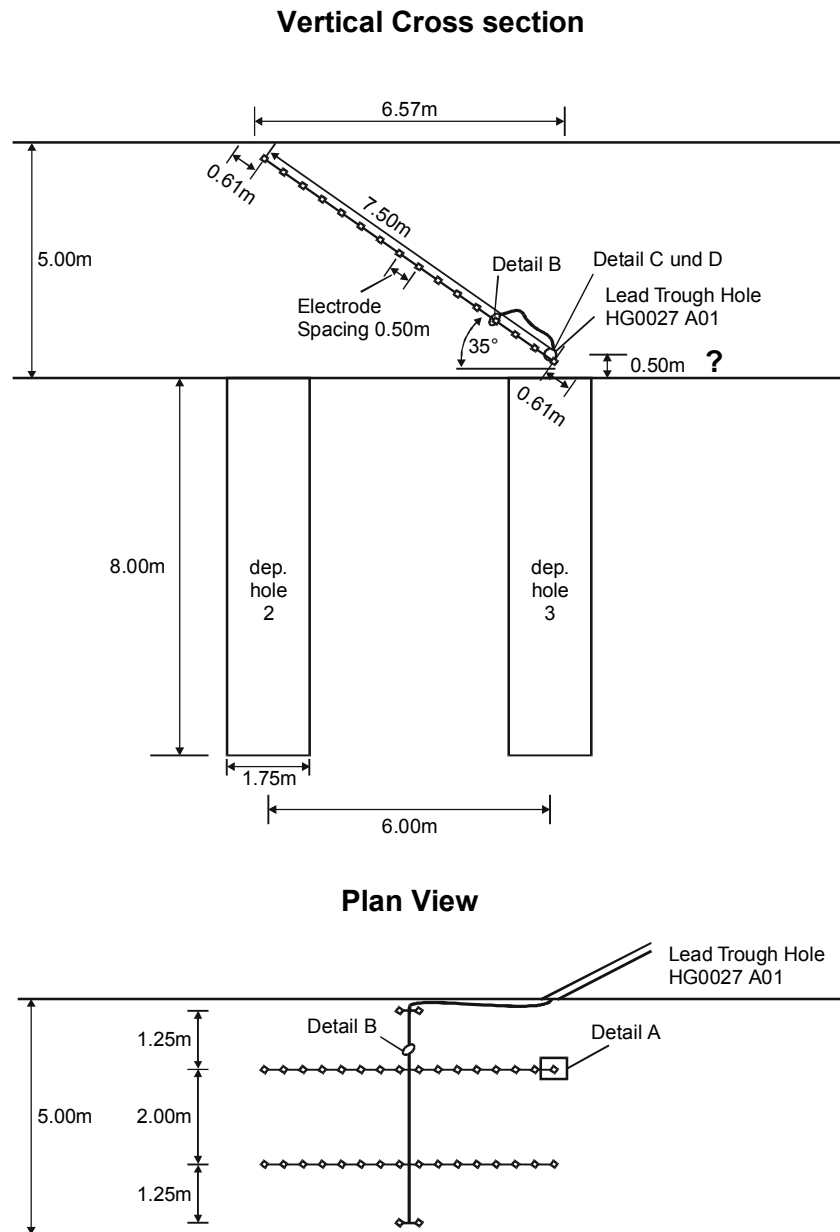
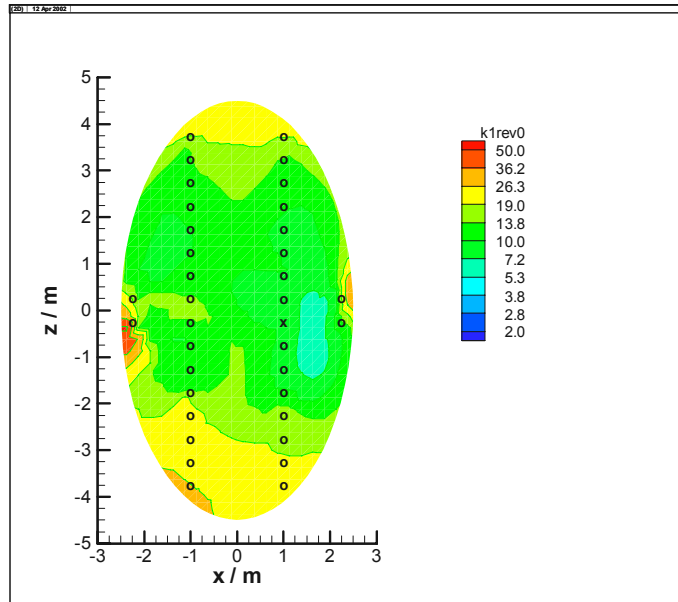
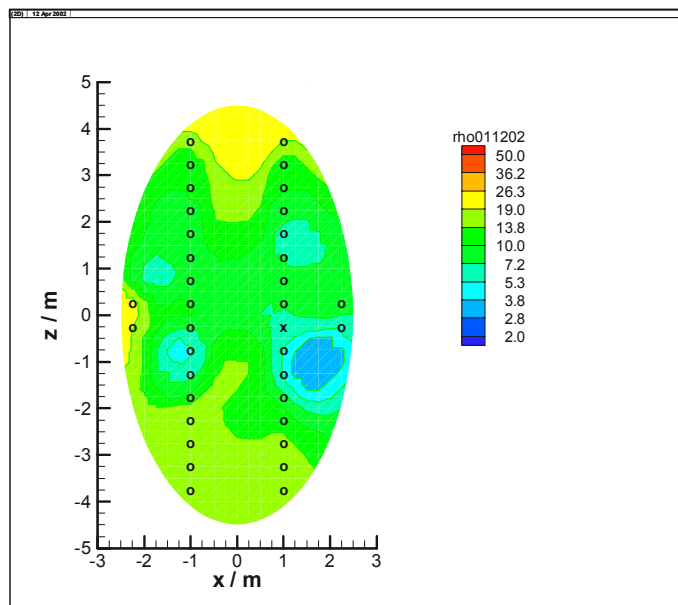

Figure 2-1: Electrode array in the backfill in section 1.

2.2 Tomograms of the backfill array in section 1



2001-10-27



2001-12-02

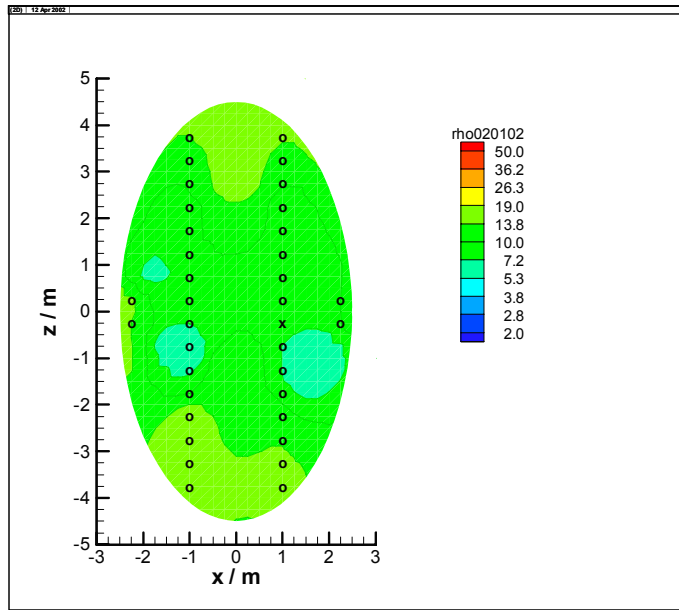

2002-01-02

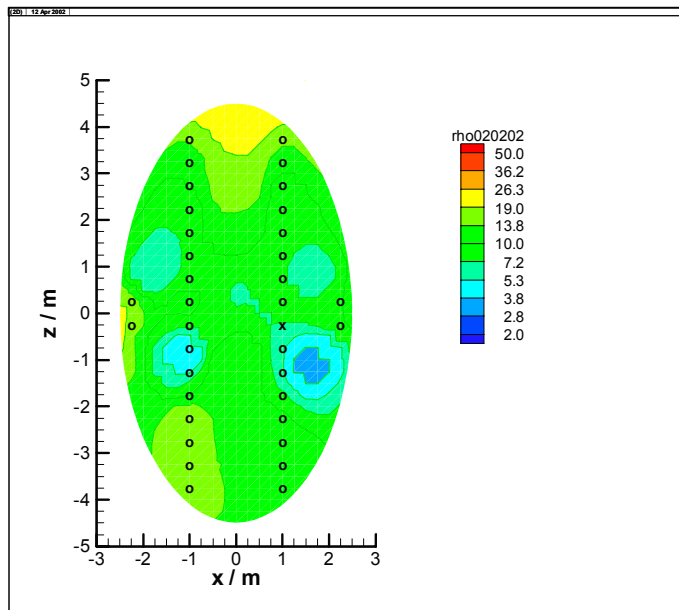

2002-02-02

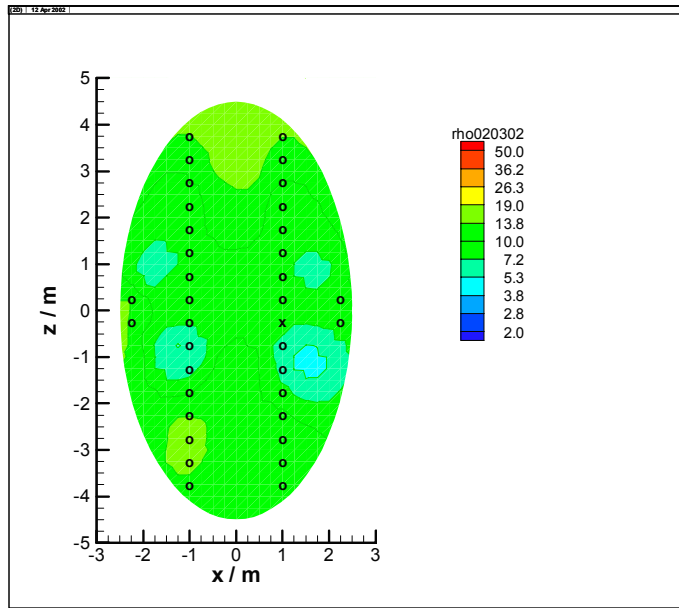

2002-03-02

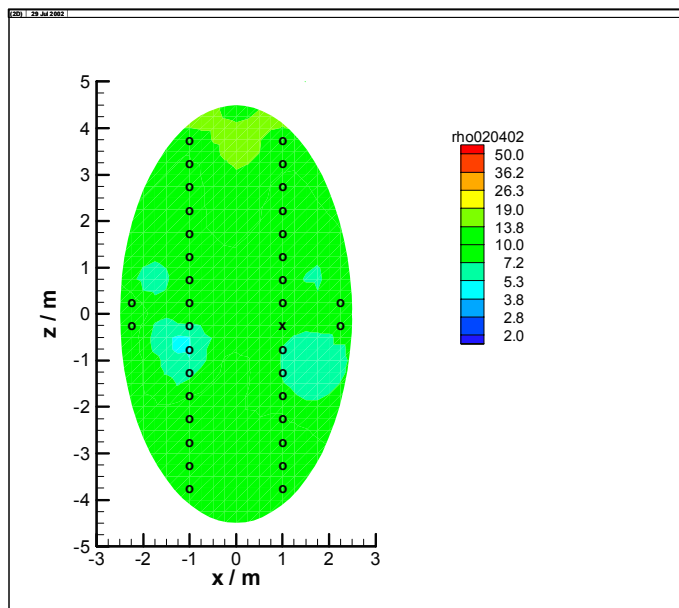

2002-04-02

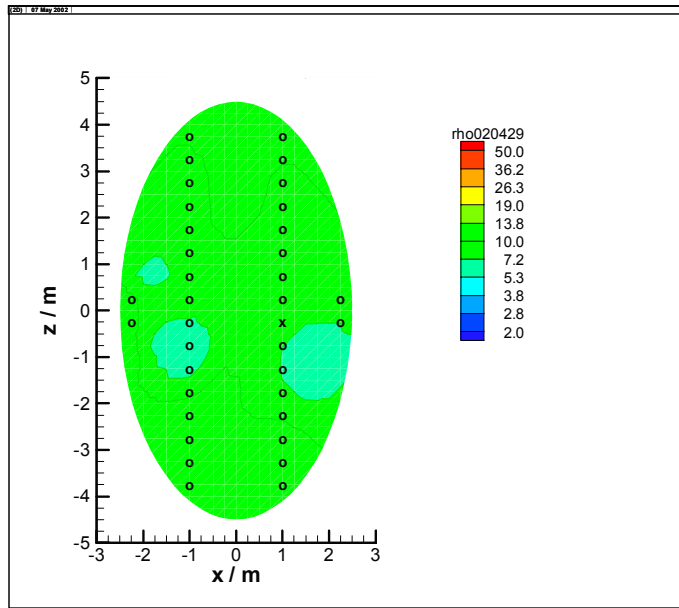

2002-04-29

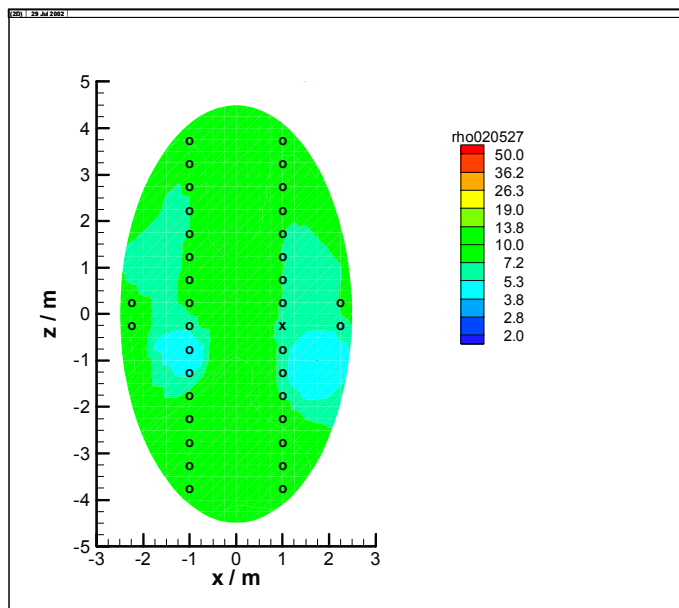

2002-05-27

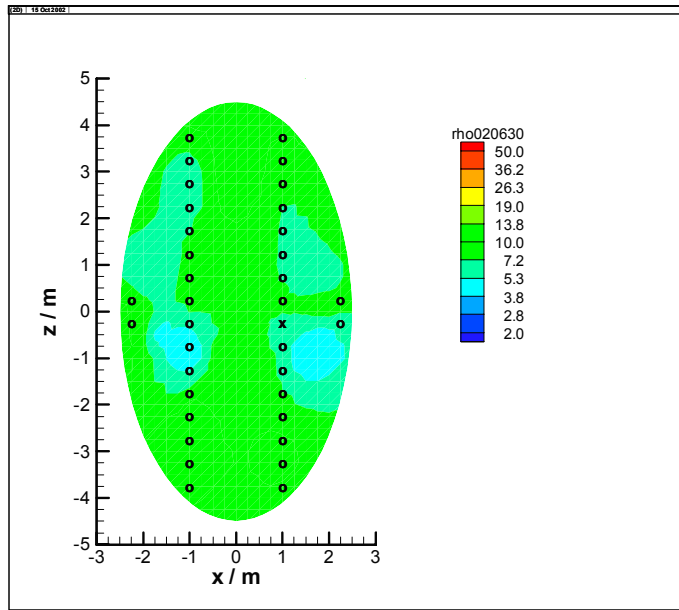

2002-06-30

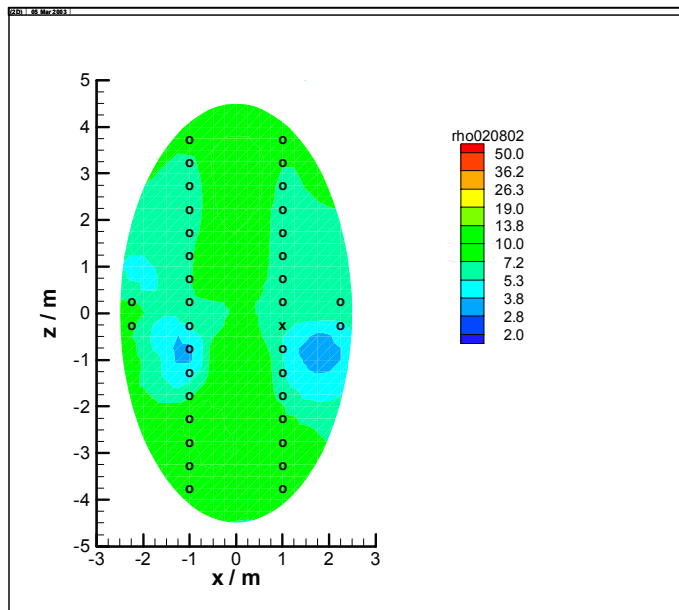

2002-08-02

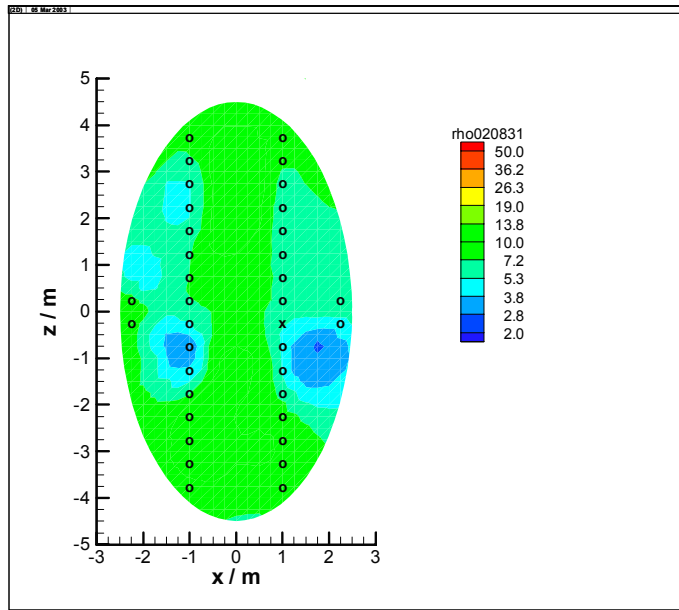

2002-08-31

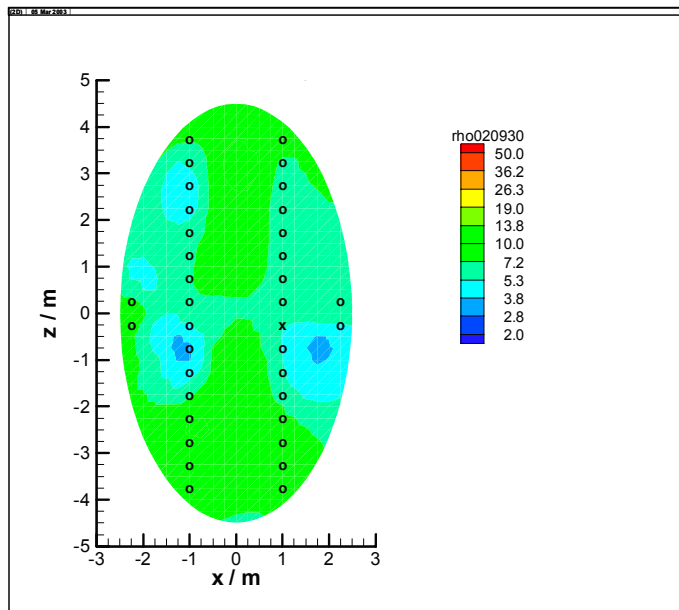

2002-09-30

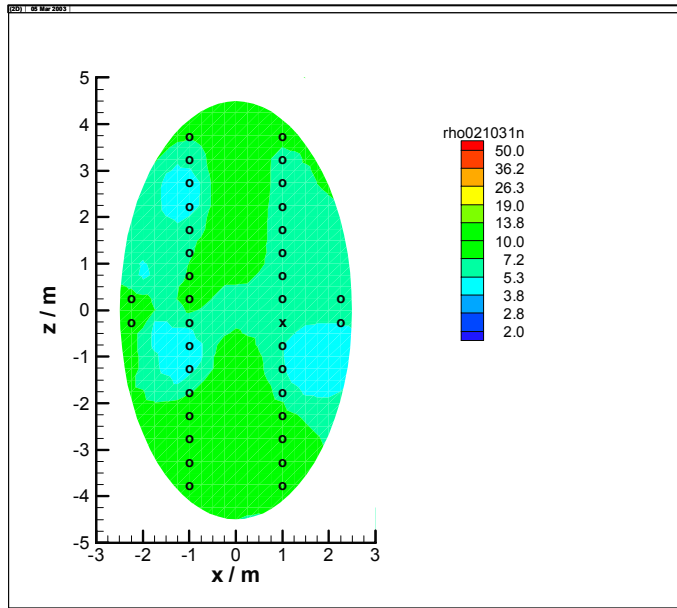

2002-10-31

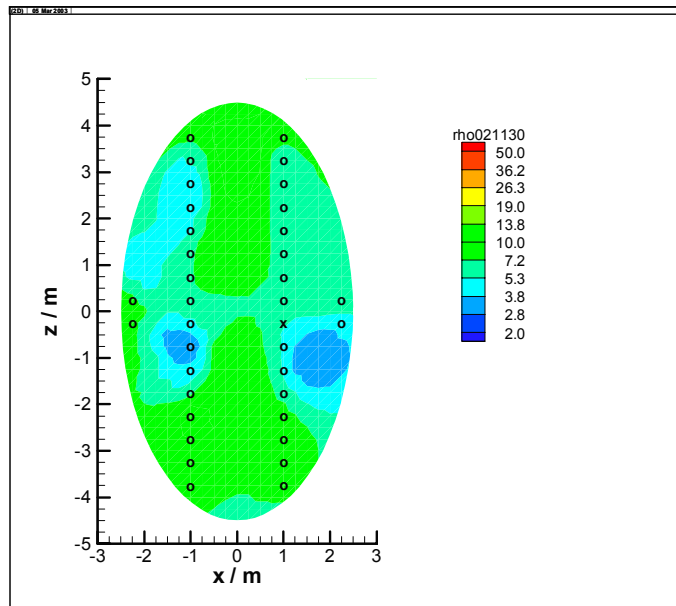

2002-11-30

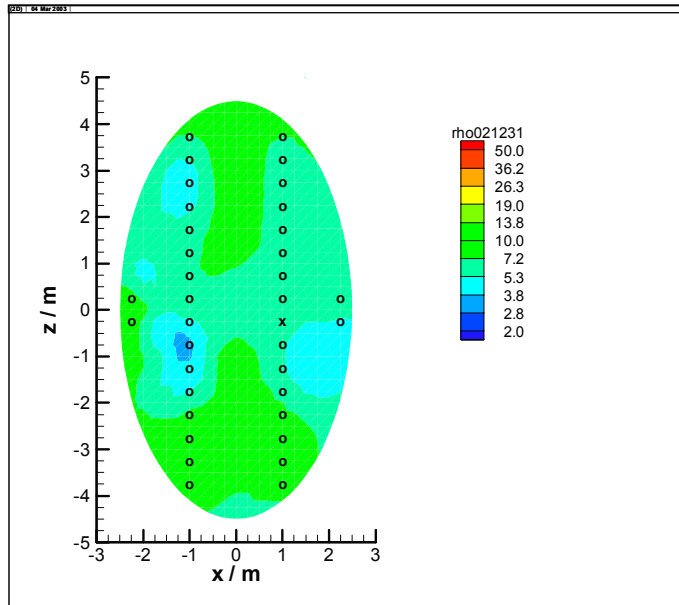

2002-12-31

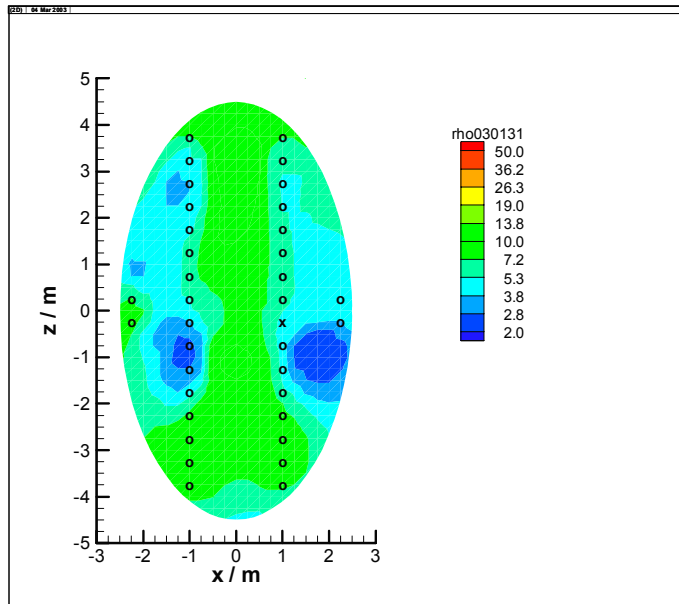

2003-01-31

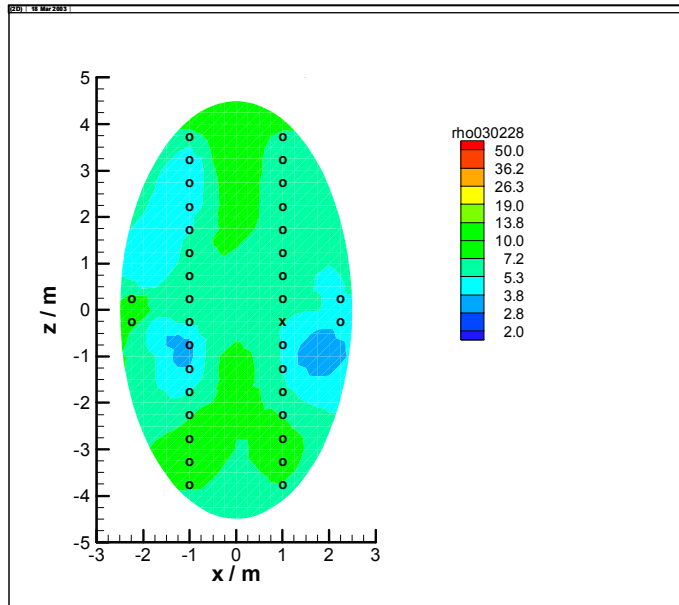

2003-02-28

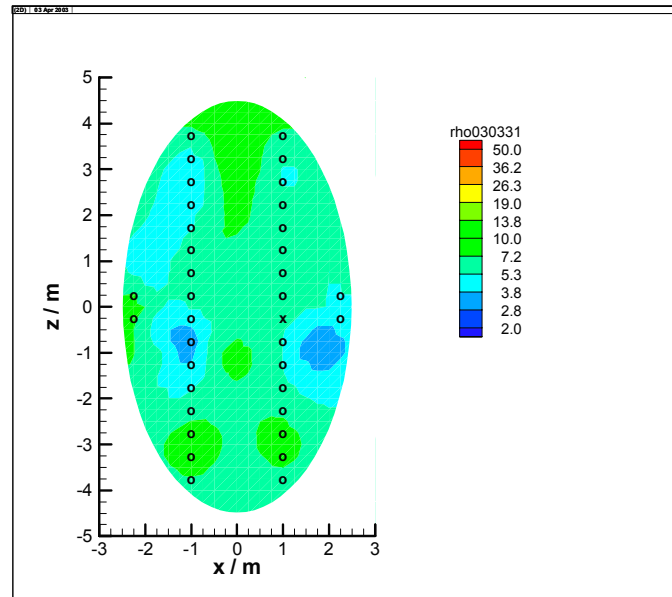

2003-03-31

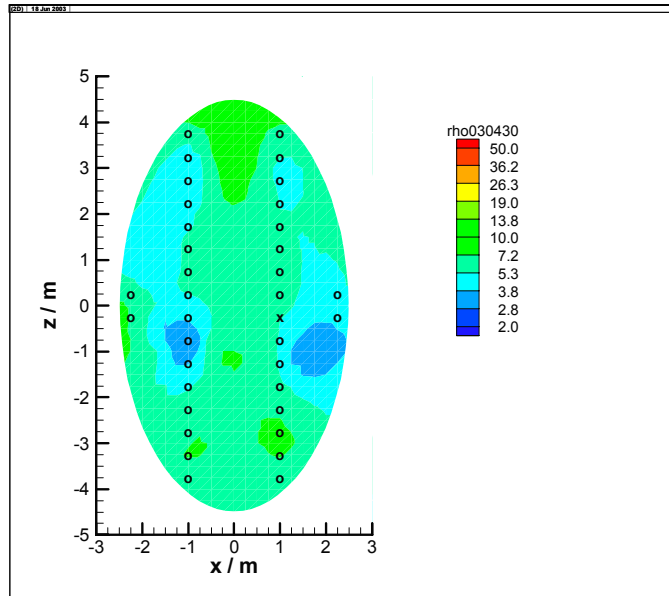

2003-04-30

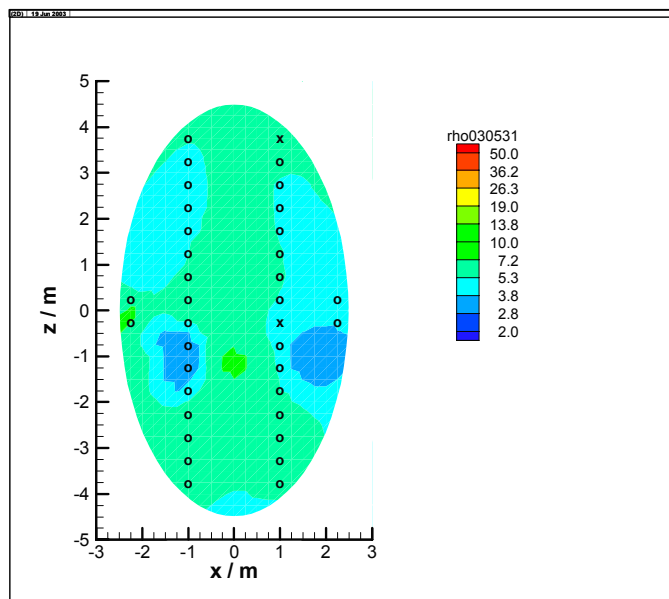

2003-05-31

2.3 Actual Interpretation

The initial resistivity value of the backfill in October 2001 is about 10 to 14 Ωm corresponding to a water content of 13 to 14%. In the following month the resistivity seems to reduce to about 7 to 10 Ωm which corresponds to a water content of about 14 to 16%. However, this reduction in resistivity is most likely generated by the wet (light blue) areas close to the electrode chains. These wet areas are the consequence of moistened backfill used during installation of the electrodes for better covering of the electrode chains. Generally, an equalization of the resistivity distribution with time can be observed. Between June and August 2002 the resistivity seems to decrease further, especially at the drift wall, to values around 6 Ωm indicating a water content of 16 to 17 %. This process continues to the middle of the drift indicating further moisture uptake in the centre of the backfill until May 2003.

Besides this overall trend, minor changes in the tomograms from month to month are visible near the edges of the gallery, especially a light blue area on the right side of the tomograms is more or less pronounced. These are no real anomalies, but are caused by the fact that inaccuracies in the measurements can lead to the accumulation of "ghost" anomalies in areas of lower sensitivity. The areas of lower sensitivity are typically the edges of the model. In case of the blue area on the right side of the tomograms, the sensitivity is more reduced because one of the electrodes (marked with an "x" in the tomograms) is not active, as its cable broke after installation during backfilling. According to the calibrations, full saturation ranging around 2 Ωm has not yet been achieved.

The resistivity is also slightly decreased by the temperature increase in the backfill. Backfill temperature amounted to maximal 32 °C in March 2003. The temperature increase, however, can result in a resistivity reduction by not more than 1 Ωm .

On May 2, 2003, the upper right electrode (also marked with an "x" in the tomogram from May 31, 2003) was lost. The reason is probably a cable failure. It is not clear whether this is already a corrosion effect.

3 Backfill Section 2

These measurements have not started yet and will not be shown until next report

4 Rock Section 2

4.1 Layout of electrode array in the rock between deposition boreholes 5 and 6

A) Vertical cross section

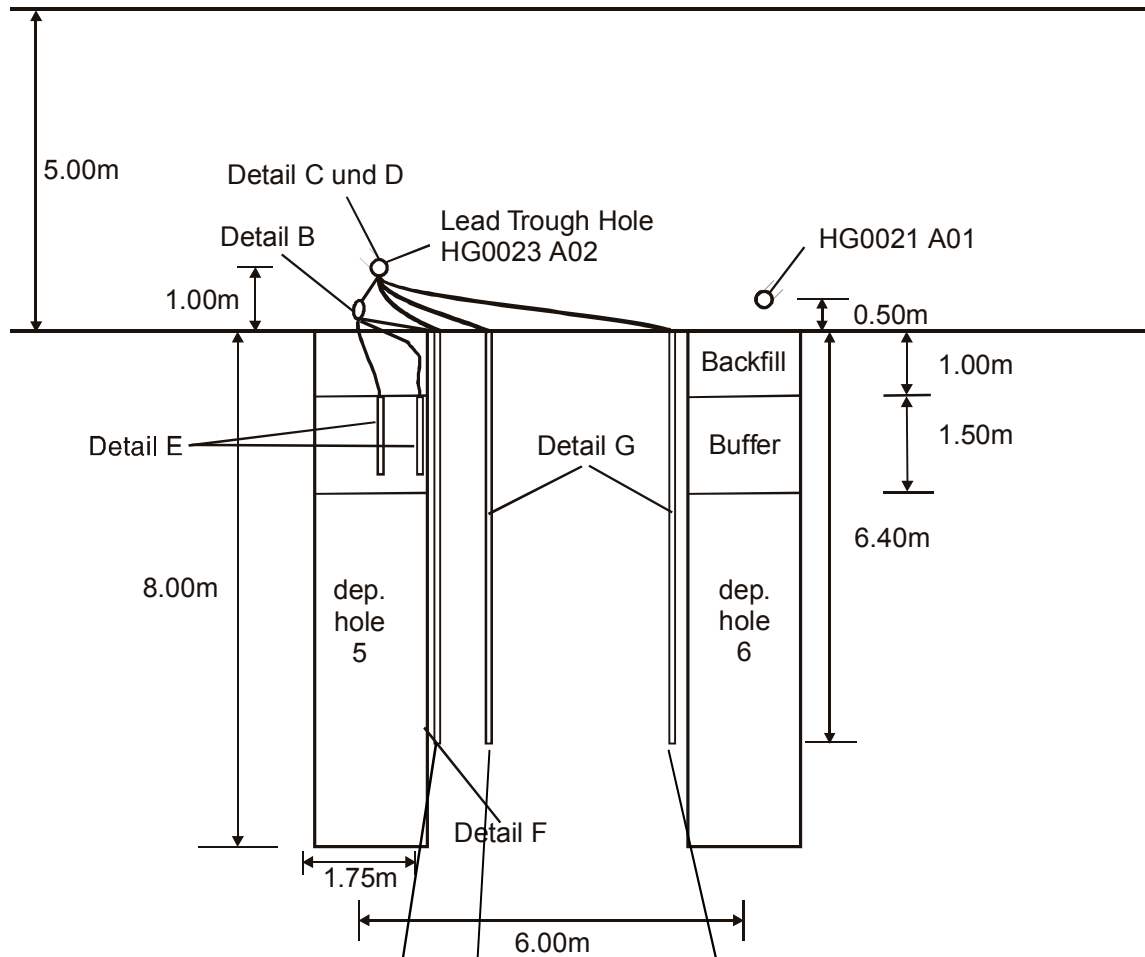

B) Plan view

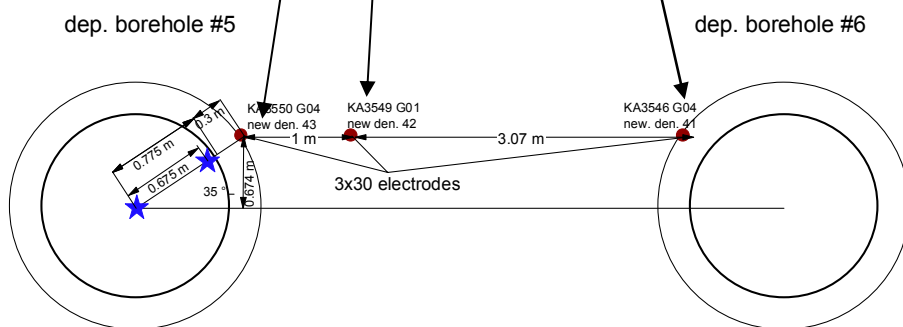

4.2 Tomograms of electrode arrays in the rock

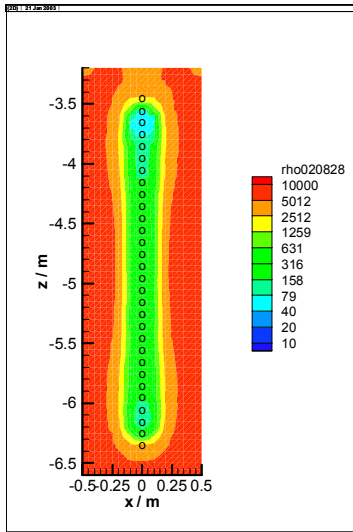

KA 3550 G04

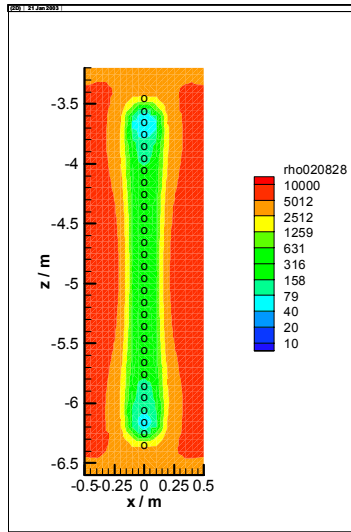

KA 3549 G01

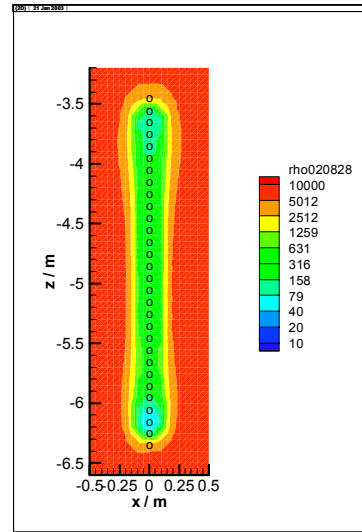

KA 3546 G04

2002-08-28

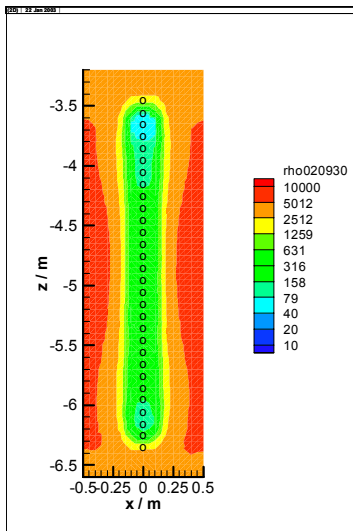

KA 3550 G04

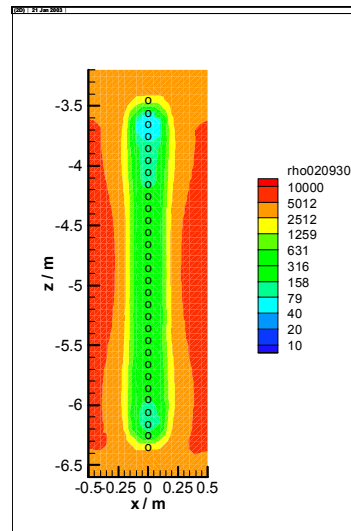

KA 3549 G01

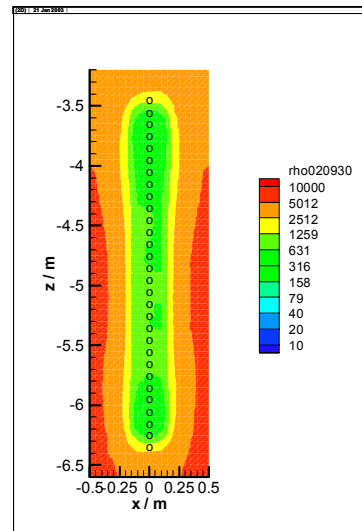

KA 3546 G04

2002-09-30

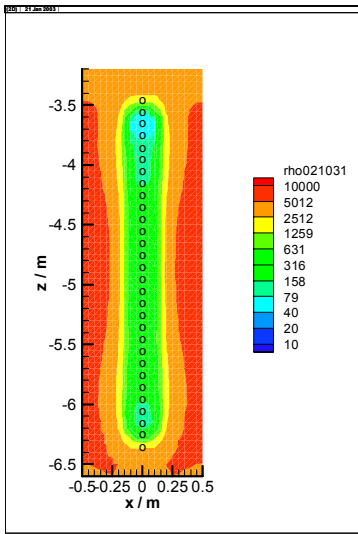

KA 3550 G04

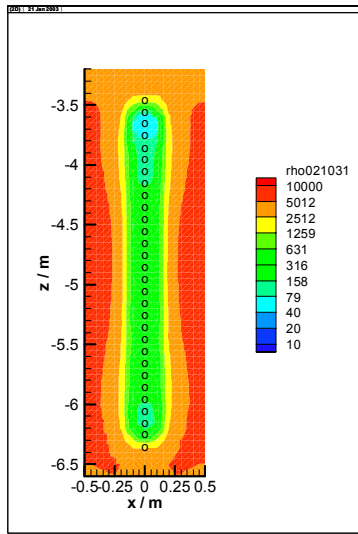

KA 3549 G01

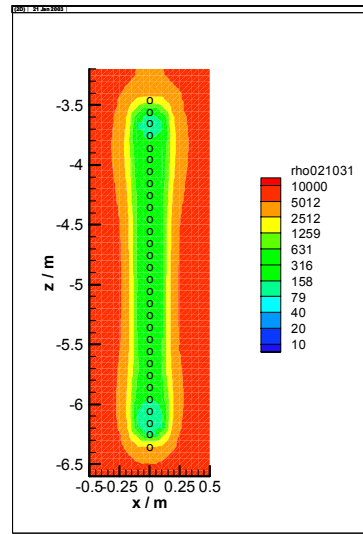

KA 3546 G04

2002-10-31

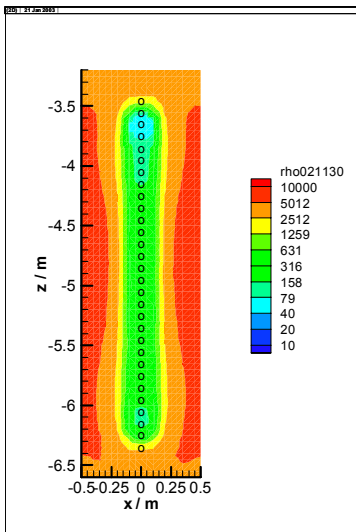

KA 3550 G04

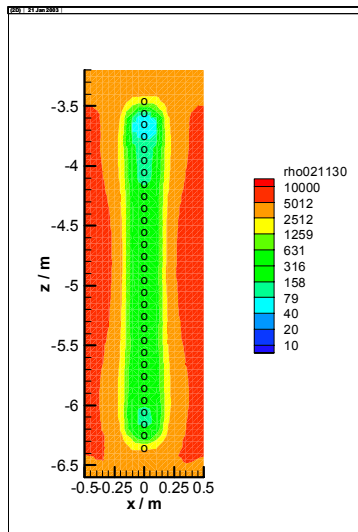

KA 3549 G01

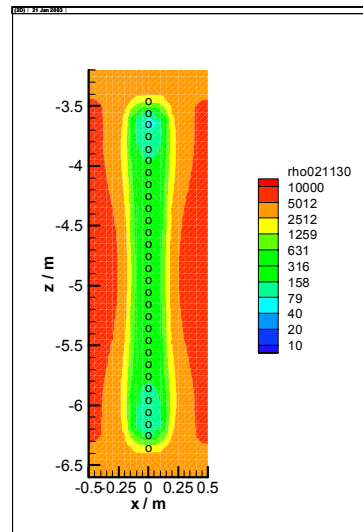

KA 3546 G04

2002-11-30

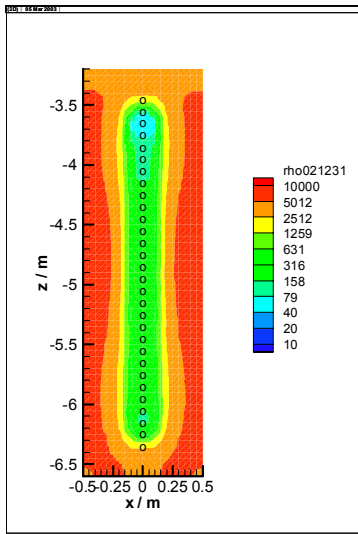

KA 3550 G04

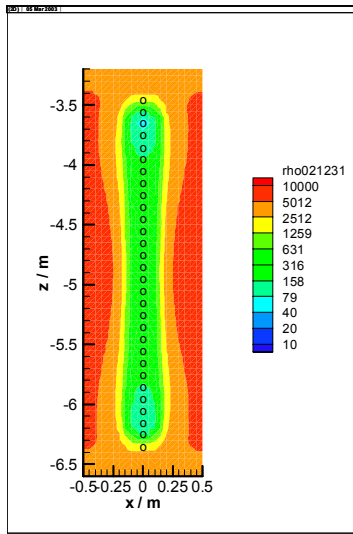

KA 3549 G01

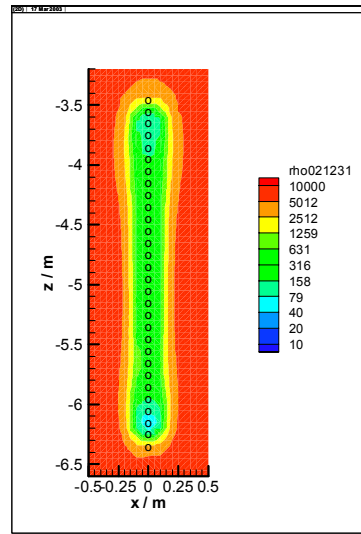

KA 3546 G04

2002-12-31

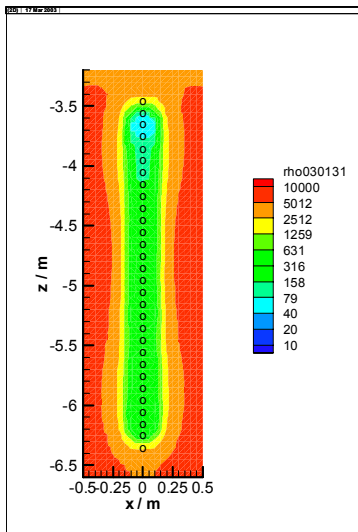

KA 3550 G04

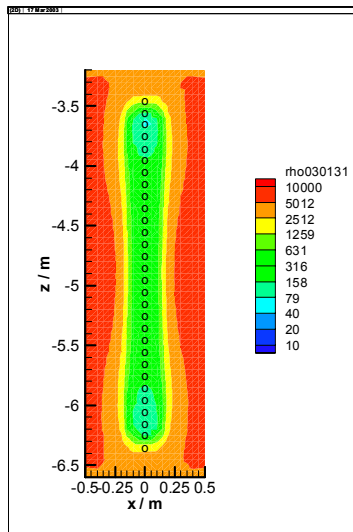

KA 3549 G01

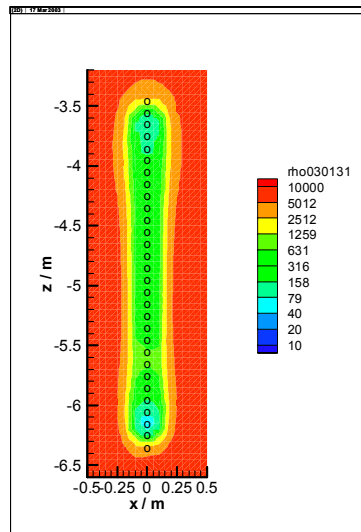

KA 3546 G04

2003-01-31

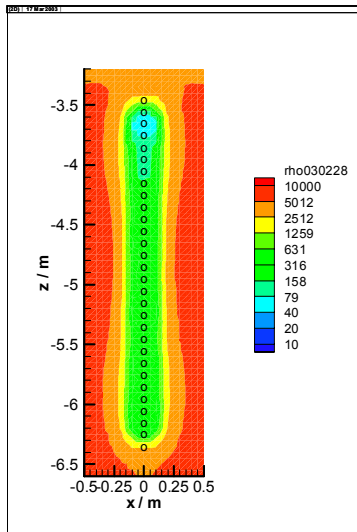

KA 3550 G04

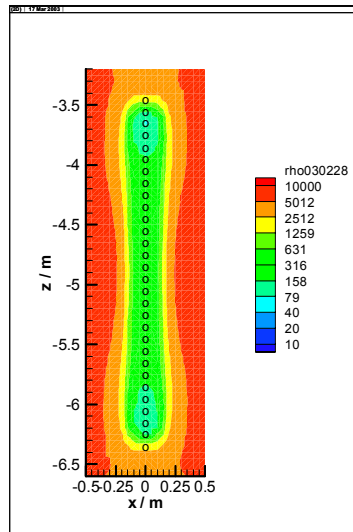

KA 3549 G01

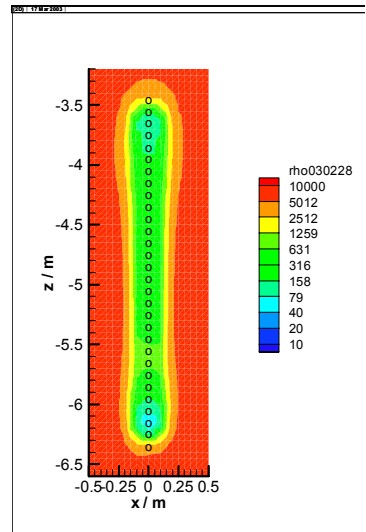

KA 3546 G04

2003-02-28

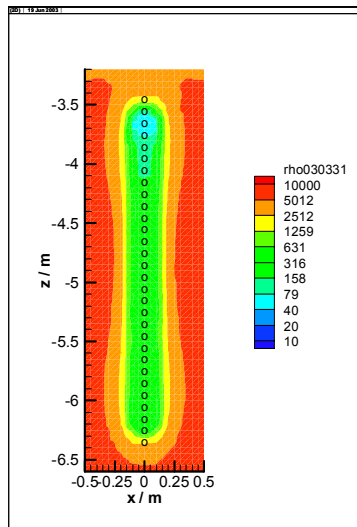

KA 3550 G04

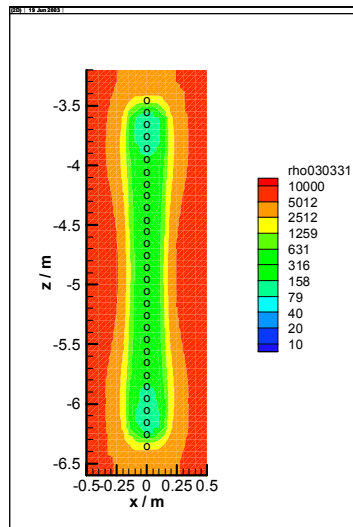

KA 3549 G01

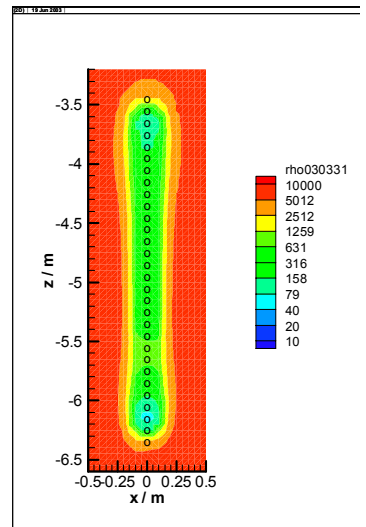

KA 3546 G04

2003-03-31

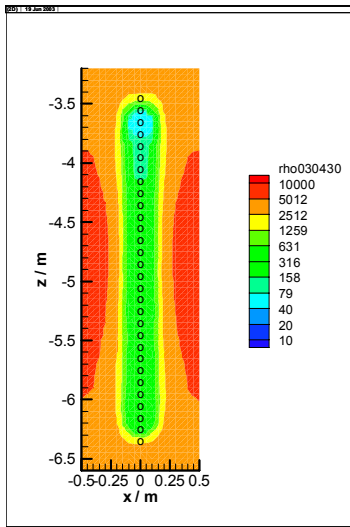

KA 3550 G04

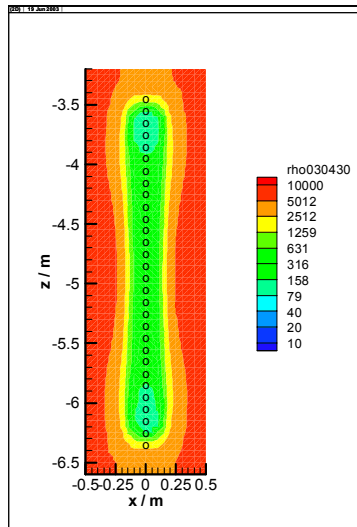

KA 3549 G01

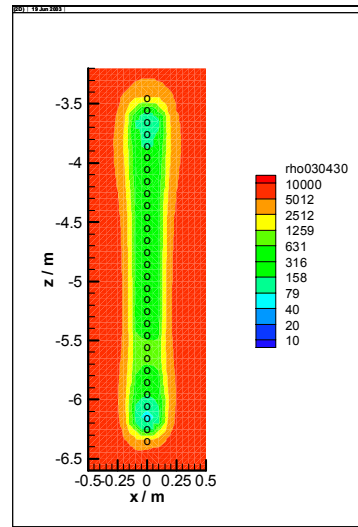

KA 3546 G04

2003-04-30

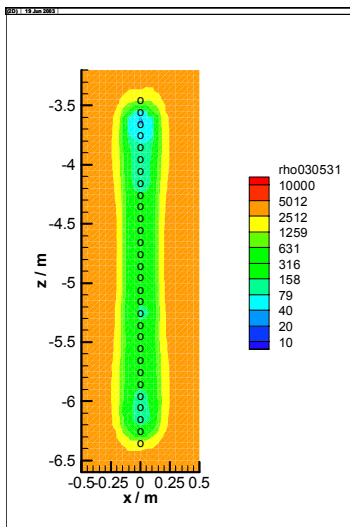

KA 3550 G04

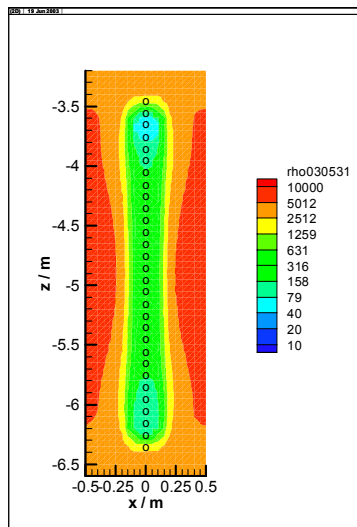

KA 3549 G01

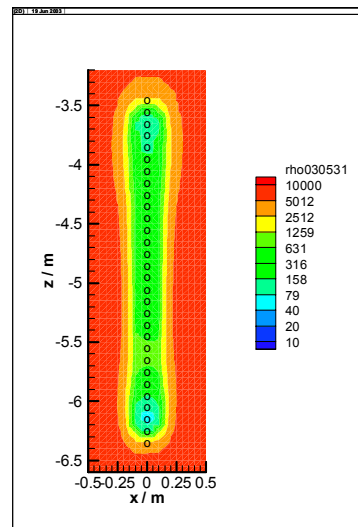

KA 3546 G04

2003-05-31

4.3 Actual Interpretation

The resistivity distributions along the three electrode chains installed in the rock are quite similar to each other and show no significant variation in time until April 2003. Close to the electrodes, the resistivity ranges around 200 Ωm . This value characterizes the water-saturated concrete used for backfilling the electrode boreholes. Further away from the boreholes, the resistivity rises to values of 2000 to 7000 Ωm which is characteristic for water-saturated granite.

From April to May 2003, there appears to be a slight decrease in resistivity in the rock around borehole KA 3550 G04. Whether this is significant and what might be the cause has to be investigated after the next measurements.

For the plane between the boreholes KA 3550 G04 and KA 3549 G01, also dipole-dipole measurements are performed. Results of these will be included in the next report.

5 Buffer in Borehole 5 in Section 2

5.1 Layout of electrode array in the buffer of deposition boreholes 5

The array is made up of the electrodes located in the buffer at the top of deposition hole #5 (see figure) and of the electrodes in the upper part of borehole KA 3550 G04 in the rock (see figure in section 4.1).

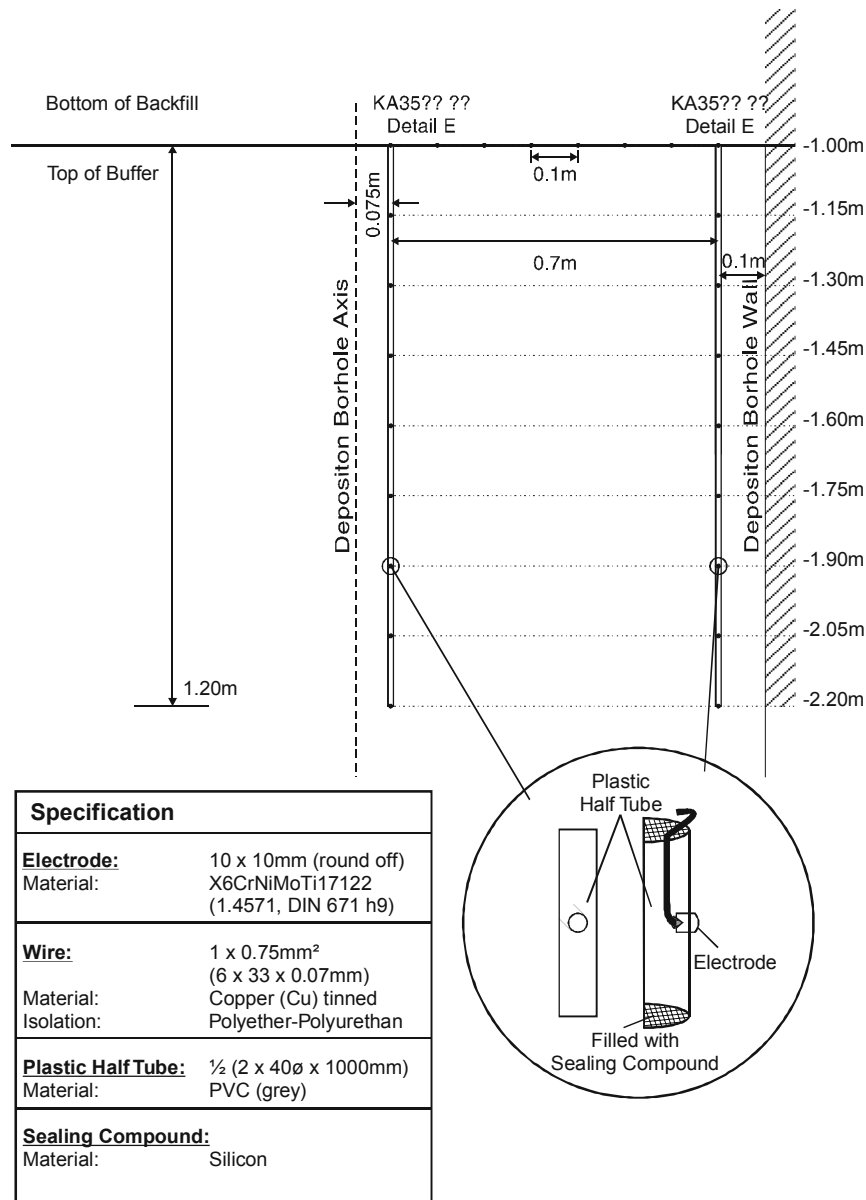

ELECTRODE DETAIL E VERS 01.CDR

5.2 Tomograms of electrode array in the buffer

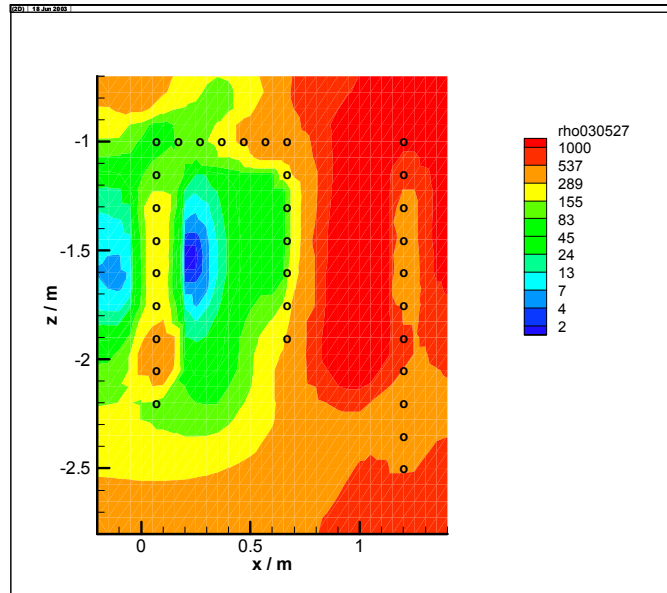

2003-05-27

5.3 Actual Interpretation

The tomogram of May 2003 (first measurement) shows the high resistivity (above $1000 \Omega\text{m}$) of the rock on the right side and the low resistivity of the buffer (below $80 \Omega\text{m}$). The picture is somewhat distorted by the fact that along the electrode chains the resistivity is increased compared to the undisturbed buffer. The increased resistivity along the electrode chains can be attributed to the refilling of the electrode boreholes with bentonite powder produced during borehole drilling. It is, however, expected that the difference will diminish with time, especially if the buffer takes up water.

Appendix 7

Water pressure in the rock and flow measurements

Rhén I. and Forsmark T., SWECO VIAK AB

Period 2001-09-01 – 2003-06-01

Water pressure measurements in the rockmass

Introduction

The hydraulic properties of the rock, geometry of tunnels and deposition holes, water pressure far away from the tunnels and the hydro-mechanical properties of the backfill and buffer govern the saturation of the buffer and backfill. It is important to measure the water pressure in the rock for the interpretation of the measurements in the buffer and backfill and to sample data useful for the modelling of the saturation process.

A short summary of the instrumentation follows below. For more details see (*Rhén et al, 2001*).

Measurements in the boreholes

A large number of boreholes have been instrumented with one or several packers. In all packed-off sections, the water pressure will be measured. Each borehole section is connected to a tube of polyamide that via lead-through holes ends in the G-tunnel. All pressure transducers are placed in the G-tunnel to facilitate easy calibration and exchange of transducers that are out of order. The transducers were connected to the HMS system at Äspö Laboratory and it is a flexible system for changing the logging frequency. The maximum scan frequency is 1/second. During periods with no hydraulic tests, preliminary the logging (storing a value in the data base) frequency will be 2/hour with an automatic increase of the sampling frequency if the pressure change since last registration is larger than 2kPa. During hydraulic tests, the sampling frequency may be up to 1 logging every 3rd second (maximum logging rate possible).

Instrumentation with bentonite packers in Section I

Section I will be in operation for a long time, possibly up to 20 years, and there will be no access to the instruments in the boreholes for a long period. It was decided to develop a new type of packer that was not dependent of an external pressure to seal-off the borehole sections. These packers were made of compacted bentonite with rubber coverage. For chemical reasons the bentonite is not allowed to be in contact with the surrounding water in the rock mass and therefore the packers have a cover made of polyurethane (PUR-rubber). This rubber also protected the packers against unwanted wetting during transport and installation. After installing all packers in a borehole, the compacted bentonite was wetted to make it swell and expanded against the borehole wall. This packer system was used in 14 boreholes with a length between 12 and 50 meters in the tunnel floor and the walls, see (*Rhén et al, 2001*).

Due to the expected high temperature near the deposition holes two boreholes (KA3574A and KA3576A) were equipped with stainless steel pipes instead of polyamide tubes.

In some sections used for circulation or hydrochemistry sampling purposes, a dummy was installed to reduce the water-filled volume of the section. Depending on the purpose the dummies were made either by high-density polyethylene (circulation sections) or PEEK (hydrochemistry sections) material. The dummy consists of two parts, to be positioned around the centre rod.

The packers were inserted into the borehole with Ø 20 mm massive stainless steel rods. A special designed manual-hoisting rig was used to insert the equipment into the boreholes. When the packers were at their correct position the equipment was attached to a locking device mounted on the tunnel wall at the borehole collar. Before insertion, the equipment was cleaned with a cleaner delivering hot steam (100 °C) at high pressure.

The instrument configuration for the boreholes provided with bentonite packers is summarised in Table 1-1 and illustrated in Figures 1-1 and 1-2.

Table 1 Instrumentation configuration in Section I. “Lead-through”: pipes between the packers.

Borehole:sec	Sec. length (m)	Type of section	Type of dummy	Packer length	Lead-through (no:diameter:type)
KA3563G:1	15 – 30.01	P		2 m	1:6/4:PA
KA3563G:2	10 – 13	P		2 m	2:6/4:PA
KA3563G:3	4 – 8	P		1 m	3:6/4:PA
KA3563G:4	1.5 – 3	P, C	HD	1 m	6:6/4:PA
KA3566G01:1	23.5 – 30.01	P		2 m	1:6/4:PA
KA3566G01:2	20 – 21.5	P, C	HD	2 m	4:6/4:PA
KA3566G01:3	12 – 18	P		2 m	5:6/4:PA
KA3566G01:4	7.3 – 10	P		1 m	6:6/4:PA
KA3566G01:5	1.5 – 6.3	P, F		1 m	8:6/4:PA
KA3566G02:1	19 – 30.1	P		1 m	1:6/4:PA
KA3566G02:2	16 – 18	P, C	HD	2 m	4:6/4:PA
KA3566G02:3	12 – 14	P		1 m	5:6/4:PA
KA3566G02:4	8 – 11	P		2 m	6:6/4:PA
KA3566G02:5	1.3 – 6	P, F		1 m	8:6/4:PA
KA3572G01:1	7.3 – 12.03	P		2 m	1:6/4:PA
KA3572G01:2	2.7 – 5.3	P, C	HD	2 m	4:6/4:PA
KA3573A:1	26 – 40.07	P		2 m	1:6/4:PA
KA3573A:2	21 – 24	P, F		2 m	3:6/4:PA
KA3573A:3	14.5 – 19	P		2 m	4:6/4:PA
KA3573A:4	10.5 – 12.5	P, F		2 m	6:6/4:PA
KA3573A:5	1.3 – 8.5	P		1 m	7:6/4:PA
KA3574G01:1	8 – 12.03	P		1 m	1:6/4:ST
KA3574G01:2	5.1 – 7	P		1 m	2:6/4:ST
KA3574G01:3	1.8 – 4.1	P, C	HD	1 m	5:6/4:ST
KA3576G01:1	8 – 12.01	P		2 m	1:6/4:ST
KA3576G01:2	4 – 6	P, HC	PE	1 m	2:6/4:ST, 1:1/8"/2:PE

Borehole:sec	Sec. length (m)	Type of section	Type of dummy	Packer length	Lead-through (no:diameter:type)
KA3576G01:3	1.3 – 3	P		1 m	3:6/4:ST, 1:1/8"/2:PE
KA3578G01:1	6.5 – 12.58	P		1 m	1:6/4:PA
KA3578G01:2	4.3 – 5.5	P, HC	PE	2 m	2:6/4:PA, 1:1/8"/2:PE
KA3579G:1	14.7 – 22.65	P		1 m	1:6/4:PA
KA3579G:2	12.5 – 13.7	P		1 m	2:6/4:PA
KA3579G:3	2.3 – 11.5	P		2 m	3:6/4:PA
KA3584G01:1	7 – 12	P		2 m	1:6/4:PA
KA3584G01:2	1.3 – 5	P		1 m	2:6/4:PA
KA3590G01:1	16 – 30	P		1 m	1:6/4:PA
KA3590G01:2	7 – 15	P, F, F		1 m	4:6/4:PA
KA3590G01:3	1.3 – 6	P, HC		1 m	5:6/4:PA, 1:1/8"/2:PE
KA3590G02:1	25.5 – 30.01	P, F		2 m	2:6/4:PA
KA3590G02:2	15.2 – 23.5	P		2 m	3:6/4:PA
KA3590G02:3	11.9 – 13.2	P, HC	PE	2 m	4:6/4:PA, 1:1/8"/2:PE
KA3590G02:4	1.3 – 9.9	P		1 m	5:6/4:PA, 1:1/8"/2:PE
KA3593G:1	25.2 – 30.02	P		1 m	1:6/4:PA
KA3593G:2	23.5 – 24.2	P, HC	PE	1 m	2:6/4:PA, 1:1/8"/2:PE
KA3593G:3	9 – 22.5	P		2 m	3:6/4:PA, 1:1/8"/2:PE
KA3593G:4	3 – 7	P, F		2 m	5:6/4:PA, 1:1/8"/2:PE
KA3600F:1	43 – 50.1	P		1 m	1:6/4:PA
KA3600F:2	40.5 – 42	P, HC	PE	1 m	2:6/4:PA, 1:1/8"/2:PE
KA3600F:3	20 – 39.5	P		2 m	3:6/4:PA, 1:1/8"/2:PE
KA3600F:4	1.3 – 18	P		1 m	4:6/4:PA, 1:1/8"/2:PE
KA3510A:1	125 – 150	P		1 m	1:6/4:PA
KA3510A:2	110 - 124	P, F		1 m	3:6/4:PA
KA3510A:3	75 - 109	P		1 m	4:6/4:PA
KA3510A:4	51 - 74	P		1 m	5:6/4:PA
KA3510A:5	4.5 - 50	P		1 m	6:6/4:PA
KG0021A01:1	42.5 – 48.82	P, HC		1 m	1:6/4:ST, 1:1/8"/2:PE
KG0021A01:2	37 – 41.5	P		1 m	2:6/4:PA, 1:1/8"/2:PE
KG0021A01:3	35 - 36	P, C	HD	1 m	5:6/4:PA, 1:1/8"/2:PE
KG0021A01:4	19 - 34	P		1 m	6:6/4:PA, 1:1/8"/2:PE
KG0021A01:5	5 - 18	P		1 m	7:6/4:PA, 1:1/8"/2:PE
KG0048A01:1	49 – 54.69	P, HC		1 m	1:6/4:ST, 1:1/8"/2:PE
KG0048A01:2	34.8 – 48	P		1 m	2:6/4:PA, 1:1/8"/2:PE
KG0048A01:3	32.8 – 33.8	P, C	HD	1 m	5:6/4:PA, 1:1/8"/2:PE
KG0048A01:4	13 – 31.8	P		1 m	6:6/4:PA, 1:1/8"/2:PE
KG0048A01:5	5 - 12	P		1 m	7:6/4:PA, 1:1/8"/2:PE

Type of section:

P Pressure measurement
C Circulation possible
HC Hydrochemistry sampling
F Flow

Materials:

PA Polyamide
ST Steel
PE PEEK
HD HD1000 (High Density Polyethylene)

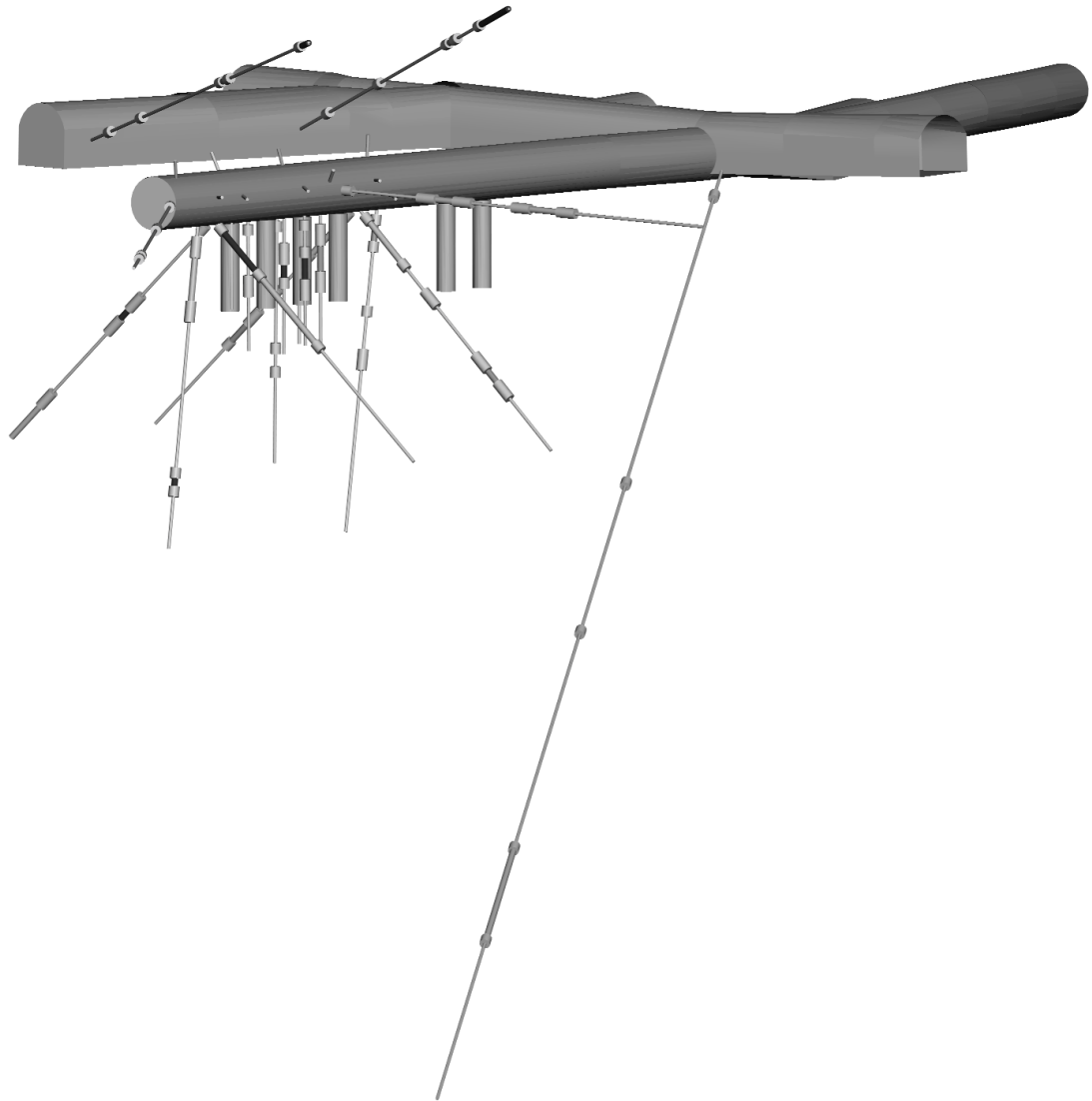

Figure 1. View of the drilled core holes in the Prototype Repository Section I. The length from the I-tunnel to the end of the TBM-tunnel is 90 m. The diameter of the TBM tunnel is 5m and the diameter of the deposition holes is 1.75 m. The depth of the deposition holes is 8.37 m in the centre and 8.15 m along the deposition hole wall. The diameter of the core holes is 76 mm except for the short core holes in the roof of the TBM tunnel that have a diameter of 56 mm. The monitoring boreholes used in the presentation in this report are located in the inner part of the tunnel surrounding the area with the four innermost canister holes. Also included are two holes drilled from the G-tunnel and the long hole KA3510A drilled from the main tunnel.

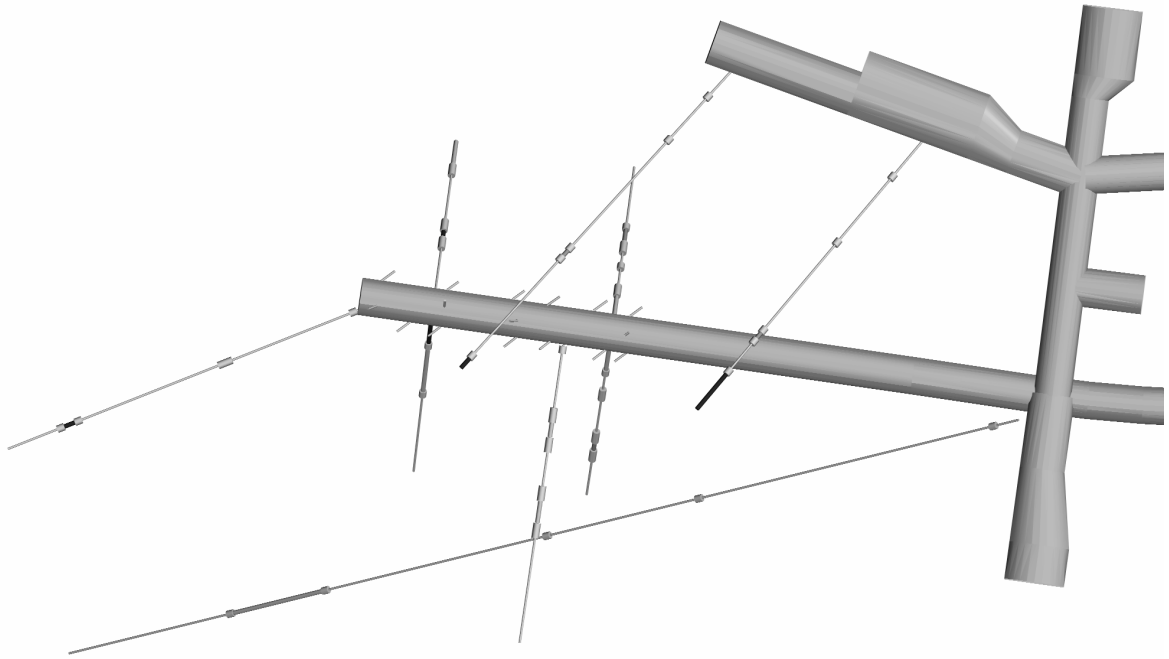

Figure 2. Overview of Sektion I in Prototype Repository

Instrumentation with hydraulic packers in Section II

Fifteen boreholes were equipped with hydraulically expanded packers of one meters length to seal off at most five sections in one borehole. In ten of these boreholes one section also were instrumented with hydro-mechanical equipment adapted to measure small deformations in the solid rock and over selected fractures. Another borehole in the G-tunnel was instrumented with HM equipment as a reference. The borehole was drilled in the north tunnel wall and is not expected to be influenced by the stress changes around the Prototype tunnel.

Table 2 Instrumentation configuration in Section II. “Lead-through”: pipes between the packers.

Borehole:sec	Sec. length (m)	Type of section	Tubes/pipes (no:diameter:type)
KA3539G:1	18.6 – 30	P	1:4/2:PA, 1:6/4:PA
KA3539G:2	15.85 – 17.6	P, HM, C	2:4/2:PA, 3:6/4:PA, 3:4/2:ST, 2:8/6:ST
KA3539G:3	10 – 14.85	P, F	3:4/2:PA, 4:6/4:PA, 3:4/2:ST, 2:8/6:ST
KA3539G:4	4 – 9	P	4:4/2:PA, 4:6/4:PA, 3:4/2:ST, 2:8/6:ST
KA3542G01:1	27 – 30	P	1:4/2:PA, 1:6/4:PA
KA3542G01:2	21.3 – 26	P	2:4/2:PA, 1:6/4:PA
KA3542G01:3	18.6 – 20.3	P, HM,C	3:4/2:PA, 3:6/4:PA, 3:4/2:ST, 2:8/6:ST
KA3542G01:4	10.5 – 17.6	P	4:4/2:PA, 3:6/4:PA, 3:4/2:ST, 2:8/6:ST
KA3542G01:5	3.5 – 9.5	P	5:4/2:PA, 3:6/4:PA, 3:4/2:ST, 2:8/6:ST
KA3542G02:1	28.2 – 30.01	P	1:4/2:PA, 1:6/4:PA
KA3542G02:2	25.6 – 27.2	P, HM, C	2:4/2:PA, 3:6/4:PA, 3:4/2:ST, 2:8/6:ST
KA3542G02:3	21.5 – 24.6	P	3:4/2:PA, 3:6/4:PA, 3:4/2:ST, 2:8/6:ST
KA3542G02:4	9 – 20.5	P	4:4/2:PA, 3:6/4:PA, 3:4/2:ST, 2:8/6:ST
KA3542G02:5	2 – 8	P, F	5:4/2:PA, 4:6/4:PA, 3:4/2:ST, 2:8/6:ST
KA3544G01:1	11.65 – 12	P	1:4/2:ST, 1:6/4:ST
KA3544G01:2	8.9 – 10.65	P, HM, C	5:4/2:ST, 3:6/4:ST, 2:8/6:ST
KA3544G01:3	3.5 – 7.9	P	6:4/2:ST, 3:6/4:ST, 2:8/6:ST
KA3546G01:1	9.3 – 12	P	1:4/2:ST, 1:6/4:ST
KA3546G01:2	6.75 – 8.3	P, HM, C	5:4/2:ST, 3:6/4:ST, 2:8/6:ST
KA3546G01:3	1.5 – 5.75	P	6:4/2:ST, 3:6/4:ST, 2:8/6:ST
KA3548A01:1	21.5 – 30	P	1:4/2:PA, 1:6/4:PA
KA3548A01:2	11.75 – 20.5	P, F	2:4/2:PA, 2:6/4:PA
KA3548A01:3	8.8 – 10.75	P, HM, C	3:4/2:PA, 4:6/4:PA, 3:4/2:ST, 2:8/6:ST
KA3548A01:4	3 – 7.8	P	4:4/2:PA, 4:6/4:PA, 3:4/2:ST, 2:8/6:ST
KA3548G01:1	6-12	P	2:6/4:PA
KA3548G01:2	2-5	P	3:6/4:PA
KA3550G01:1	8.3 – 12.03	P	1:4/2:ST, 1:6/4:ST
KA3550G01:2	5.2 – 7.3	P, HM, C	5:4/2:ST, 3:6/4:ST, 2:8/6:ST
KA3550G01:3	1.8 – 4.2	P	6:4/2:ST, 3:6/4:ST, 2:8/6:ST
KA3550G05:1	1.5 – 3	P	1:4/2:ST, 1:6/4:ST
KA3551G05:1	1.5 – 3.1	P	1:4/2:ST, 1:6/4:ST
KA3552G01:1	7.05 – 12	P	1:4/2:ST, 1:6/4:ST
KA3552G01:2	4.35 – 6.05	P, HM, C	5:4/2:ST, 3:6/4:ST, 2:8/6:ST
KA3552G01:3	1.5 – 3.35	P	6:4/2:ST, 3:6/4:ST, 2:8/6:ST
KA3554G01:1	25.15 – 30.01	P	1:4/2:PA, 1:6/4:PA
KA3554G01:2	22.6 – 24.15	P, HM, C	2:4/2:PA, 3:6/4:PA, 3:4/2:ST, 2:8/6:ST
KA3554G01:3	14 – 21.6	P	3:4/2:PA, 3:6/4:PA, 3:4/2:ST, 2:8/6:ST
KA3554G01:4	5 – 13	P	4:4/2:PA, 3:6/4:PA, 3:4/2:ST, 2:8/6:ST
KA3554G01:5	1.5 – 4	P	5:4/2:PA, 3:6/4:PA, 3:4/2:ST, 2:8/6:ST
KA3554G02:1	22 – 30.01	P	1:4/2:PA, 1:6/4:PA
KA3554G02:2	15.9 – 21	P	2:4/2:PA, 1:6/4:PA

Borehole:sec	Sec. length (m)	Type of section	Tubes/pipes (no:diameter:type)
KA3554G02:3	13.2 – 14.9	P	3:4/2:PA, 1:6/4:PA
KA3554G02:4	10.5 – 12.2	P, HM, C	4:4/2:PA, 3:6/4:PA, 3:4/2:ST, 2:8/6:ST
KA3554G02:5	1.5 – 9.5	P	5:4/2:PA, 3:6/4:PA, 3:4/2:ST, 2:8/6:ST
KA3557G:1	15 – 30.04	P	1:4/2:PA, 1:6/4:PA
KA3557G:2	1.5 – 14	P	2:4/2:PA, 1:6/4:PA
KG0010B01:1	2.8 – 4.35	HM	3:4/2:ST, 2:8/6:ST

Type of section:

P Pressure measurement
 C Circulation possible
 HM Hydro-mechanical measurements

Materials:

PA Polyamide tube
 ST Stainless steel pipe
 F Flow

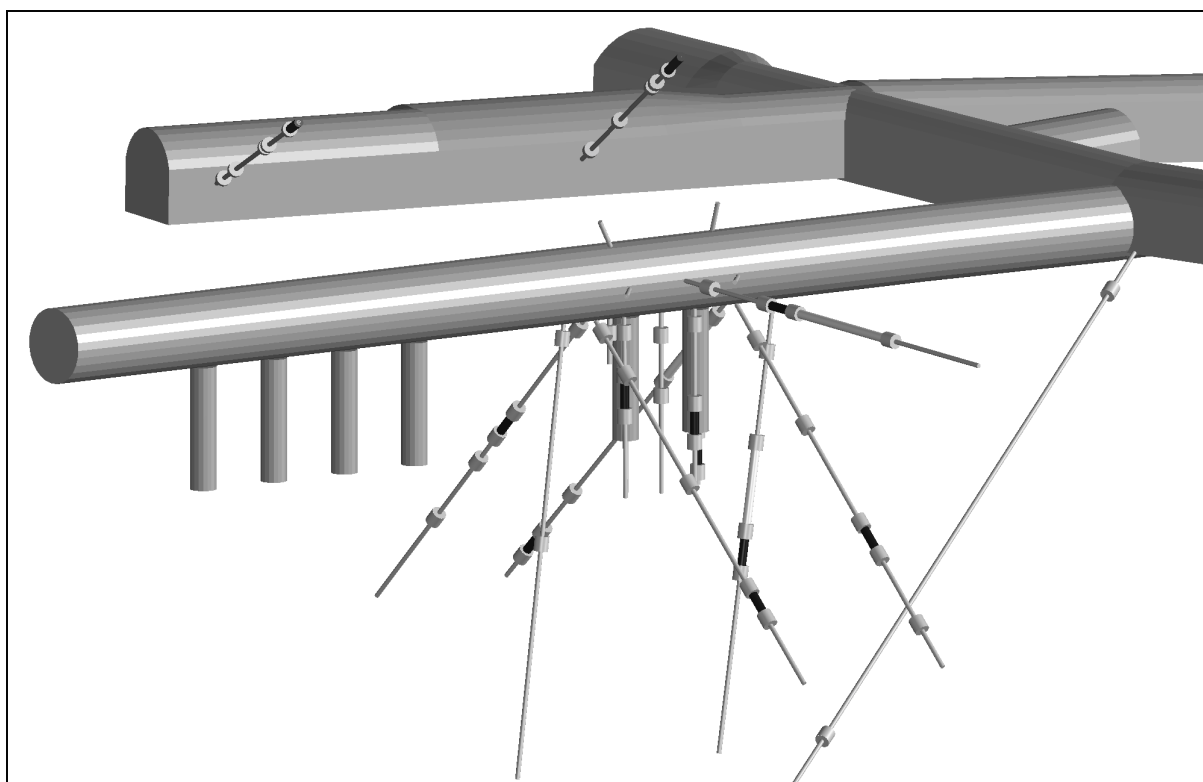

Figure 3 View of the drilled core holes in the Prototype Repository Section II. The length from the I-tunnel to the end of the TBM-tunnel is 90 m. The diameter of the TBM tunnel is 5m and the diameter of the deposition holes is 1.75 m. The depth of the deposition holes is 8.37 m in the centre and 8.15 m along the deposition hole wall. The diameter of the core holes is 76 mm except for the short core holes in the roof of the TBM tunnel that have a diameter of 56 mm. The monitoring boreholes used in the presentation in this report are located in the inner part of the tunnel surrounding the area with the four innermost canister holes. Also included are two holes drilled from the G-tunnel and the long hole KA3510A drilled from the main tunnel.

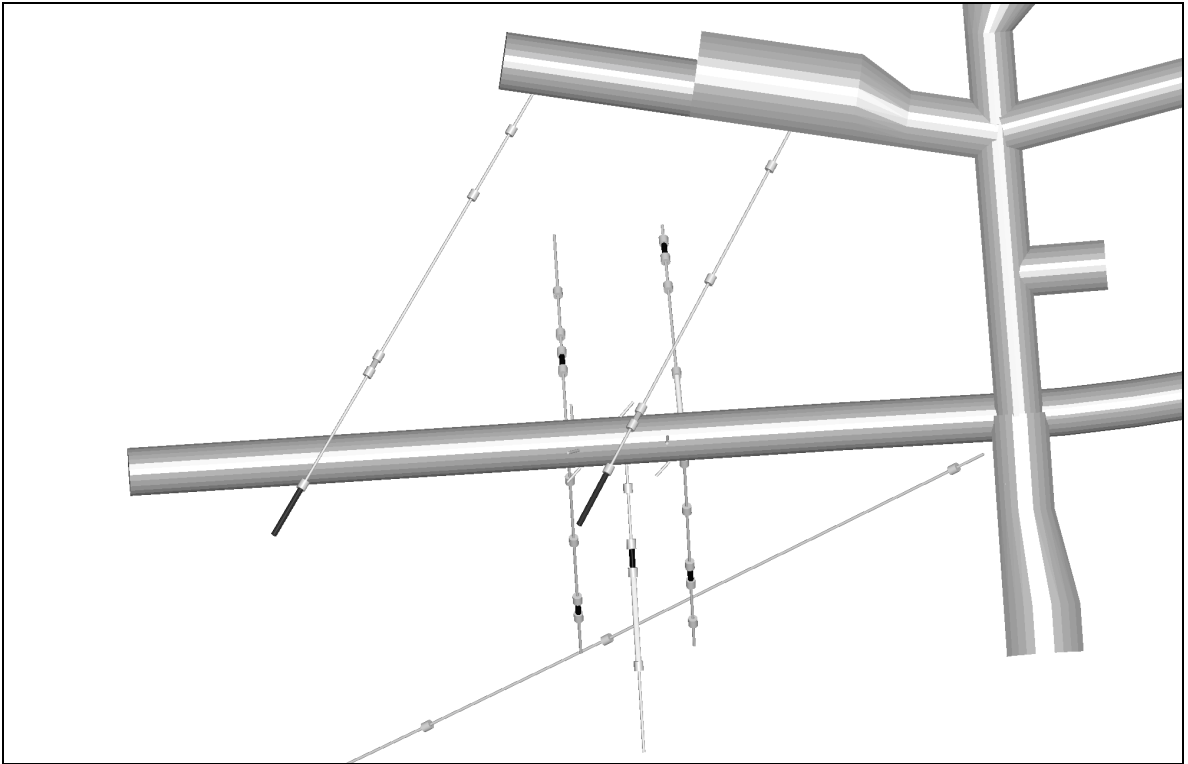

Figure 4 Overview of Sektion II in Prototype Repository

Instrumentation with mechanical packers

Twenty-two short boreholes (2 m) in the tunnel roof and walls were equipped with mechanical packers, see Table 2. After insertion into the hole, the pulling of a nut on the centre pipe expanded the packer. Since these holes were directed upwards, the de-airation required an extra lead-through connected to a tube ending in the innermost part of the borehole. The de-airation was made during the backfilling and in boreholes with very little flow the de-airation was made by filling water through the outer tube.

Table 2 Boreholes instrumented with mechanical packers (“Inclination”: inclination of the borehole.).

Borehole	Borehole length (m)	Inclination (°)
KA3543A01	2.06	-0.8
KA3543I01	2.06	70.5
KA3548D01	2.06	2.7
KA3552A01	2.06	-2.8
KA3552H01	2.1	58.2
KA3553B01	2.02	-37.7
KA3563A01	2.06	-7.7
KA3563D01	approx. 2	2.8
KA3563I01	2.15	73
KA3566C01	2.1	3.5
KA3568D01	2.3	-2.3
KA3573C01	2.05	34.9
KA3574D01	2.05	12.6
KA3578C01	2.09	-5.4
KA3578H01	1.9	59.1
KA3579D01	2	-1
KA3588C01	2.04	-4
KA3588D01	1.9	-1.8
KA3588I01	1.96	65.6
KA3592C01	2.1	4.4
KA3597D01	2.22	3.1
KA3597H01	2.06	55.1

Calibration intervals

Recalibration of pressure transducers are made a couple of times every year. In *Table 3* the calibration dates this far are shown

Table 3 Calibration dates

Calibration dates
2002-01-04
2002-04-12
2002-08-15
2002-12-16
2003-04-03

Pressure measurements

In this section pressure measurements of all monitored holes in Prototype section I is shown in plots below. The pressure values plotted are daily mean values. The definition of day 0 is the day the heating of canister 1 started, i.e. 2001-09-17.

The position of pressure measurement is indicated for all observation sections.

In Table 4 a key to the numbering of the days are detailed

Table 4 Key to numbering of days

Day number	Date
0	2001-09-17
50	2001-11-06
100	2001-12-26
150	2002-02-14
200	2002-04-05
250	2002-05-25
300	2002-07-14
350	2002-09-02
400	2002-10-22
450	2002-12-11
500	2003-01-30
550	2003-03-21
600	2003-05-10

In general sections close to the prototype rock wall indicate lower pressure head than further away from the prototype. Of the 22 short 2 meters holes 5 show pressure heads above 1000 kPa with a maximum in KA3573C01 of approximately 3500 kPa.

In the longer holes the section closest to the wall have a lower head than sections deeper into the rockmass. The exceptions from this are noted in KA3566G01, KA3579G and KA3593G.

A pressure drop 2002-05-07 (Day 232) for most of the observation sections are shown in the plots. The most major pressure change happens in the lowest section of KA3566G02 (approx. 70 m) but are also clearly visible for section 2-4 of the same borehole. The pressure recovered during the evening of 2002-12-02. The cause for the pressure change is unknown.

Several sections have a slight decreasing trend since the summer of 2002.

The instrumentation of boreholes in Section II started 2002-11-06 and continued until the beginning of December 2002. Several sections indicate a pressure drop around 2002-11-11 (Day 420) which probably is caused by the installation work.

The sections of KA3510A show a drop of pressure during the the first week of December 2002. The pressure is quickly re-established. Probably the cause for this was the on-going monitoring work in Section II. The data sampling of KA3510A was cut short 2003-02-12. The reason for this is being investigated.

During the period 2003-05-08 (Day 598) until 2003-05-15 (Day 605) a total of 19 hydraulic tests were done in several of the boreholes in Section I and II. The tests caused groundwater pressure interference in the whole of the prototype repository area. Since the tests were mostly short-time tests it is only shown in some of the borehole section plots.

Drainage of Section I

The drainage system in Section I is still in operation, which can be connected to the lack of pressure increase in most borehole sections. The pumped amount is approximately 2.5 L/min.

Flow measurements

Earlier estimations and measurements of inleaking ground water amounts to the tunnel system are presented in (*Forsmark T, Rhén I, 2001*) and (*Rhén I, Forsmark T, 2001*).

Data from three flow weirs are presented in this data report.

A newly constructed weir at the tunnel G opening measures the inleaking amounts from this tunnel. The weir is named MG0004G. The pumped water amounts from Section I mentioned above is included in the rates from this weir station.

The weir MF0061G halfway down tunnel F measures the inleaking amounts from the north part of tunnel J (J+) and the first half of tunnel F, see plot of this weir. Early in the presented period, autumn 2001, inleaking water from tunnel G was led to tunnel F and weir MF0061G thereby to some extent explaining the high flowrate during that period.

The weir MA3426G measures the flow rates from the south part of tunnel J, tunnel I and tunnel A chainage 3426 – 3600 m.

Displacement measurements

Displacement measurements in borehole sections with Hydro-Mechanical anchors in Section II are on-going but no results are available yet.

References

Forsmark T, Rhén I, 2001. Äspö HRL – Prototype repository. Hydrogeology - Injection test campaign 2. flow measurement of DA3575G01, groundwater salinity, ground water leakage into G-, I- and J-tunnels. SKB IPR-01-31.

Rhén I, Forsmark T, Torin L, 2001. Äspö HRL – Prototype repository. Hydrogeological, hydrochemical and temperature measurements in boreholes during the operation phase of the prototype repository. Tunnel section I. SKB IPR-01-32.

Rhén I, Forsmark T, Magnusson J, Alm P, 2003. Äspö HRL – Prototype repository. Hydrogeological, hydrochemical, hydromechanical and temperature measurements in boreholes during the operation phase of the prototype repository. Tunnel section II. SKB IPR-03-XX (in print).

Rhén I, Forsmark T, 2001. Äspö HRL – Prototype repository. Hydrogeology, Summary report of investigations before the operation phase. SKB IPR-01-65.

KA3510A PRESSURE HEAD

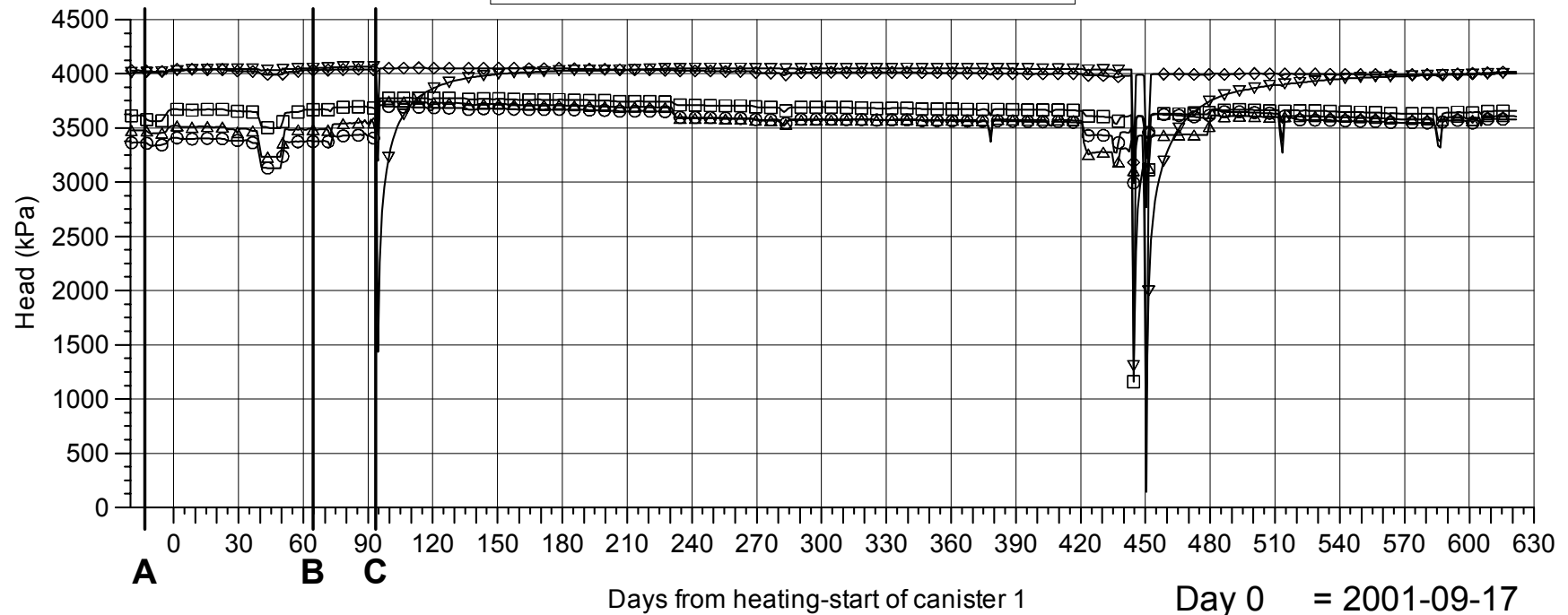

Day 0 = 2001-09-17
 Day 622 = 2003-06-01

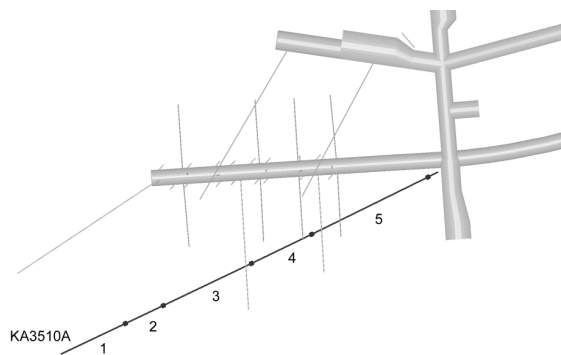

Events

- A - Start backfilling 2001-09-03
- B - Stop backfilling 2001-11-20
- C - Casting inner plug finalized

Borehole sections

- ▽ — A:1 125 m - 150 m
- ◇ — A:2 110 m - 124 m
- □ — A:3 75 m - 109 m
- ○ — A:4 51 m - 74 m
- ▲ — A:5 4.5 m - 50 m

KA3539G PRESSURE HEAD

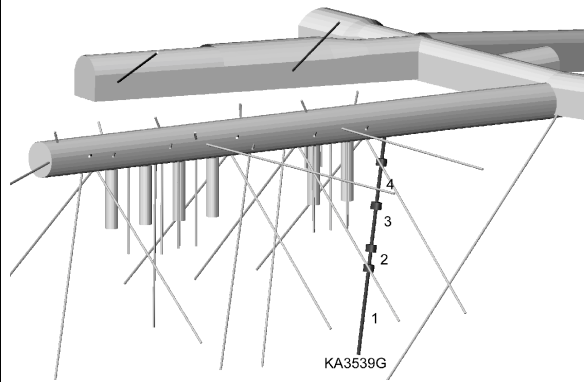
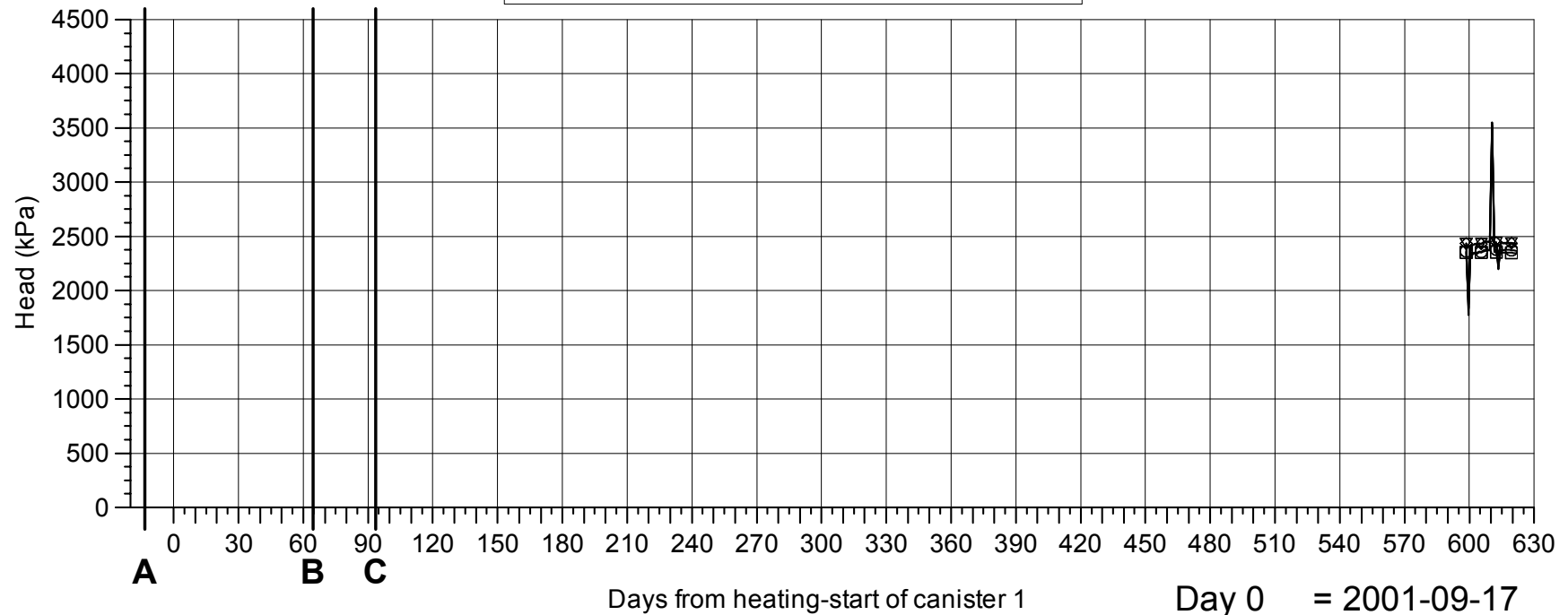

Events

A - Start backfilling 2001-09-03
 B - Stop backfilling 2001-11-20
 C - Casting inner plug finalized

Borehole sections

—▽— G:1 18.6 m - 30 m
 —◇— G:2 15.85 m - 17.6 m
 —□— G:3 10 m - 14.85 m
 —○— G:4 4 m - 9 m

KA3542G01 PRESSURE HEAD

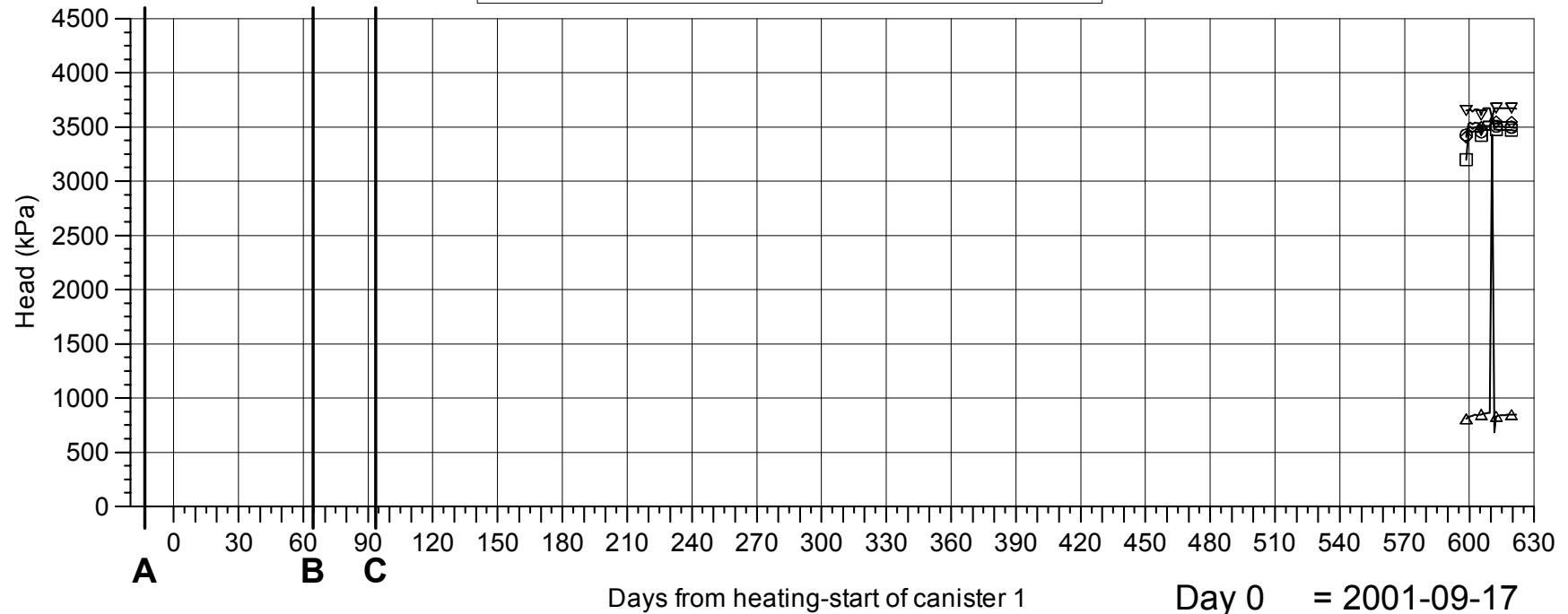

Days from heating-start of canister 1

Day 0 = 2001-09-17
Day 622 = 2003-06-01

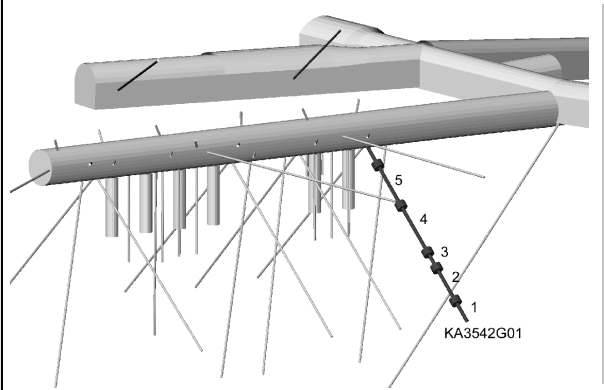

Events

A - Start backfilling 2001-09-03
B - Stop backfilling 2001-11-20
C - Casting inner plug finalized

Borehole sections

- ▽— G01:1 27 m - 30 m
- ◇— G01:2 21.3 m - 26 m
- G01:3 18.6 m - 20.3 m
- G01:4 10.5 m - 17.6 m
- △— G01:5 3.5 m - 9.5 m

KA3542G02 PRESSURE HEAD

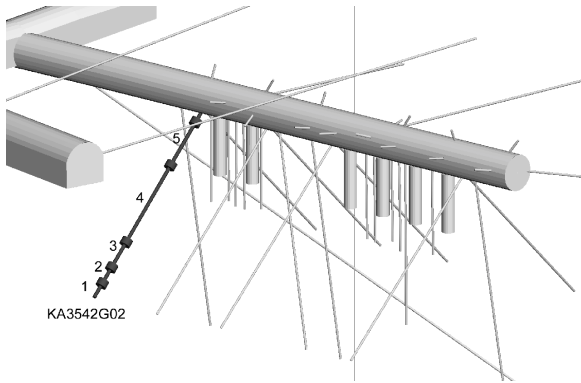
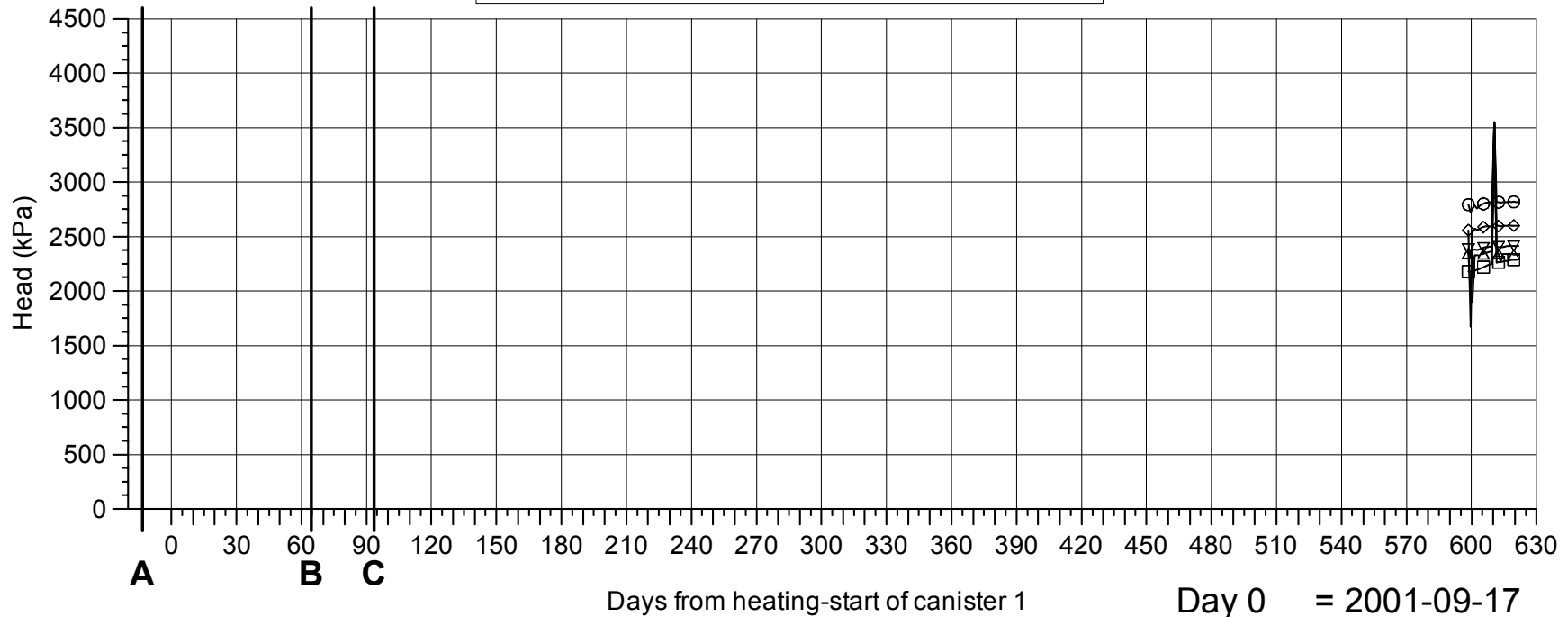

Events

- A - Start backfilling 2001-09-03
- B - Stop backfilling 2001-11-20
- C - Casting inner plug finalized

Borehole sections

- ▽— G02:1 28.2 m - 30.01 m
- ◇— G02:2 25.6 m - 27.2 m
- G02:3 21.5 m - 24.6 m
- G02:4 9 m - 20.5 m
- △— G02:5 2 m - 8 m

P_KA3542G02.GRF 2003-06-16

KA3543A01, KA3543I01, KA3548D01 PRESSURE HEAD

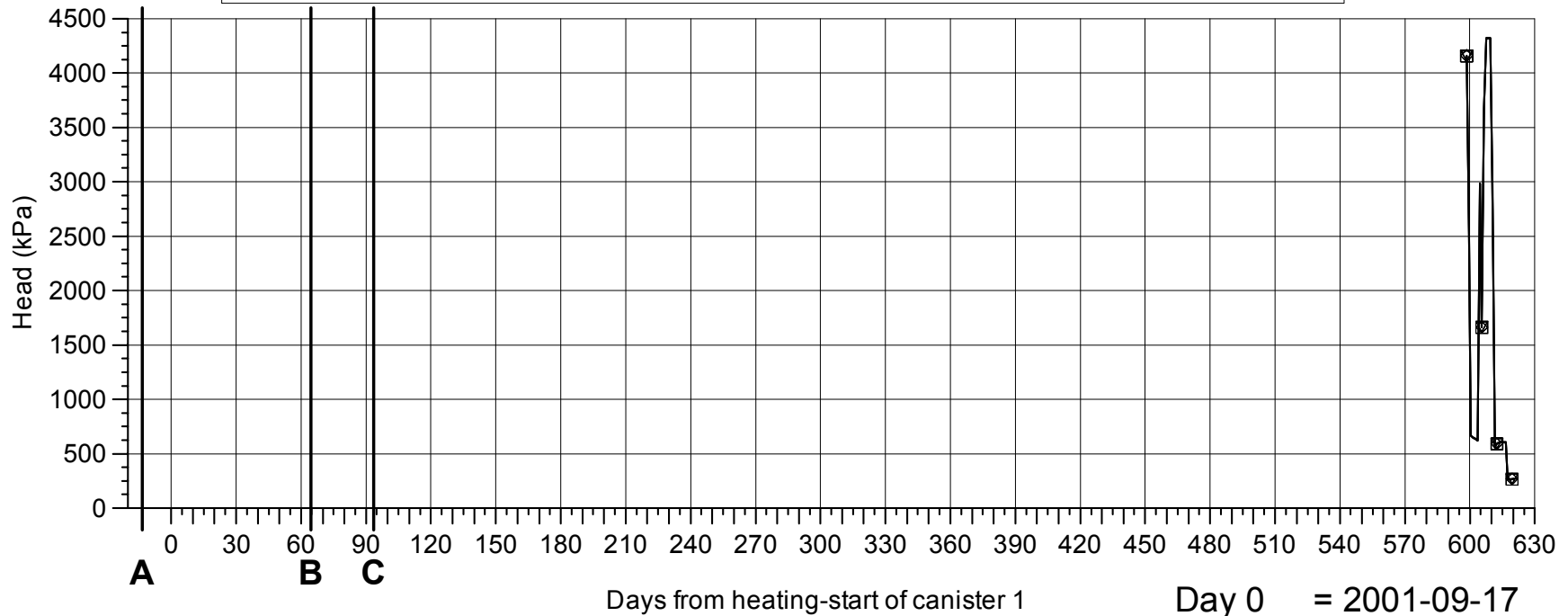

Day 0 = 2001-09-17
 Day 622 = 2003-06-01

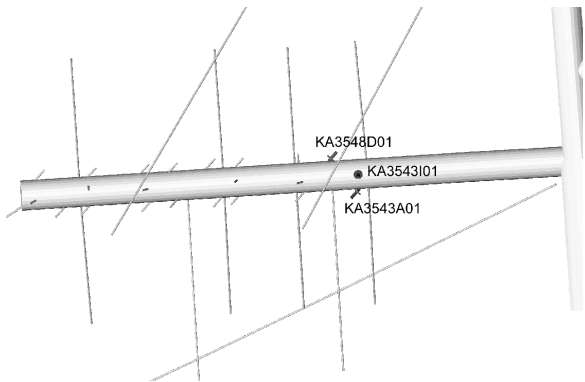

Events

- A - Start backfilling 2001-09-03
- B - Stop backfilling 2001-11-20
- C - Casting inner plug finalized

Borehole sections

- ▽— KA3543A01:1 0.65 m - 2 m
- ◇— KA3543I01:1 0.65 m - 2 m
- KA3548D01:1 0.65 m - 2 m

KA3544G01 PRESSURE HEAD

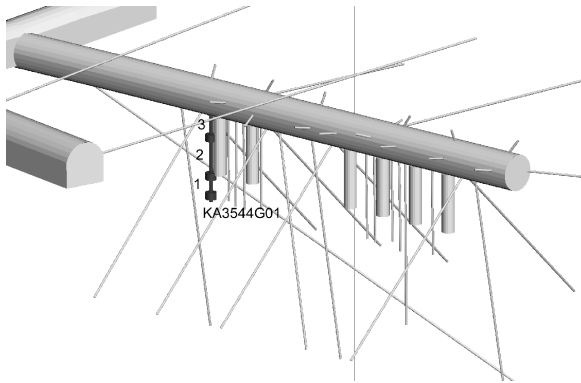
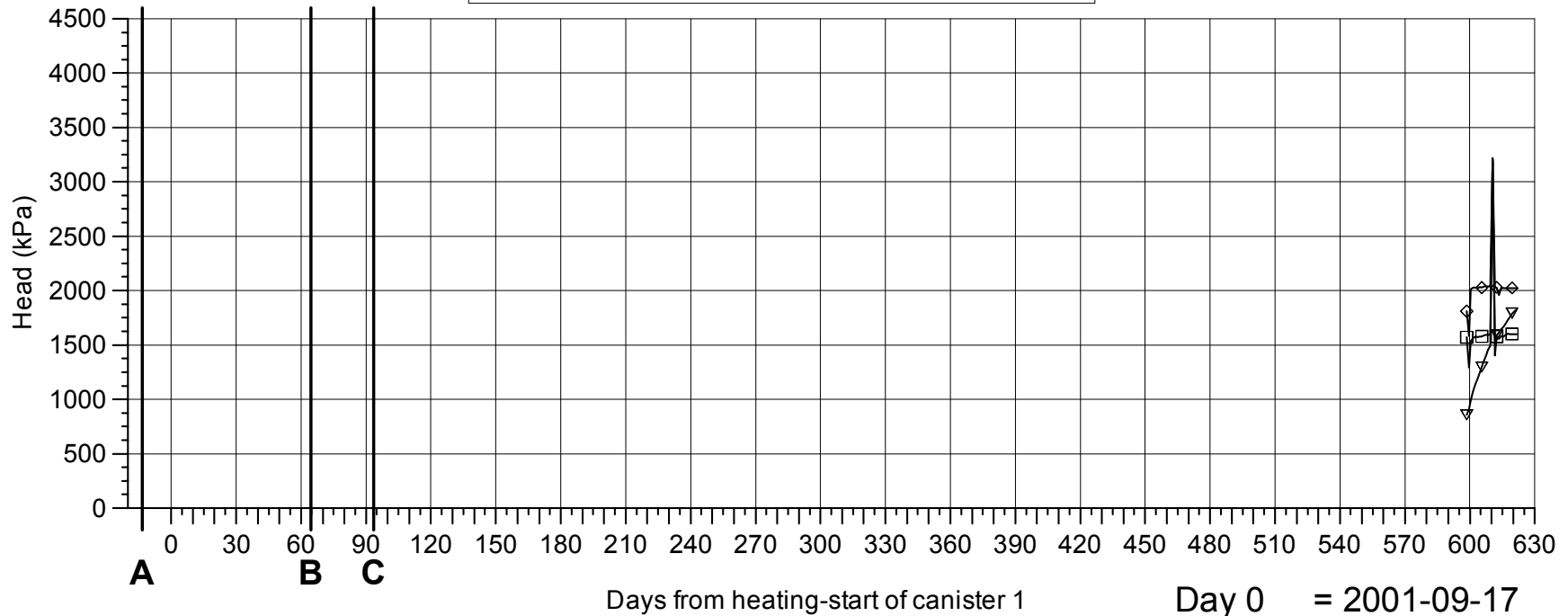

Events

- A - Start backfilling 2001-09-03
- B - Stop backfilling 2001-11-20
- C - Casting inner plug finalized

Borehole sections

- ▽— G01:1 11.65 m - 12 m
- ◇— G01:2 8.9 m - 10.65 m
- G01:3 3.5 m - 7.9 m

P_KA3544G01.GRF 2003-06-16

KA3546G01 PRESSURE HEAD

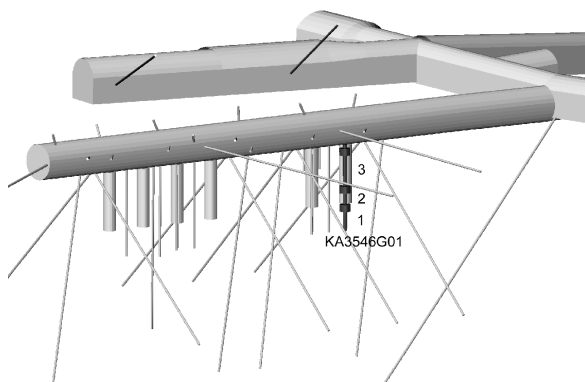
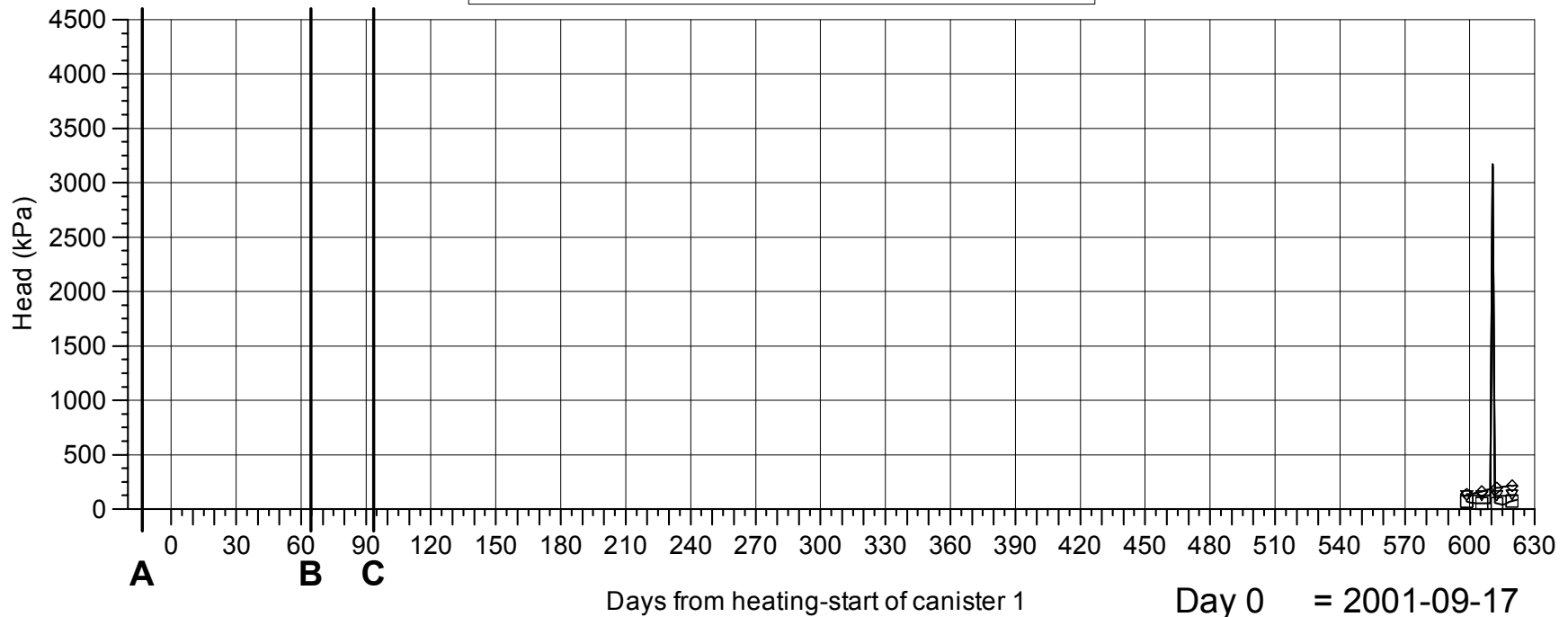

Events

A - Start backfilling 2001-09-03
 B - Stop backfilling 2001-11-20
 C - Casting inner plug finalized

Borehole sections

—▽— G01:1 9.3 m - 12 m
 —◇— G01:2 6.75 m - 8.3 m
 —□— G01:3 1.5 m - 5.75 m

KA3548A01 PRESSURE HEAD

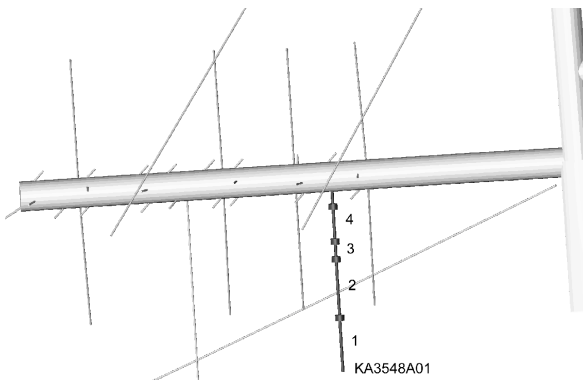
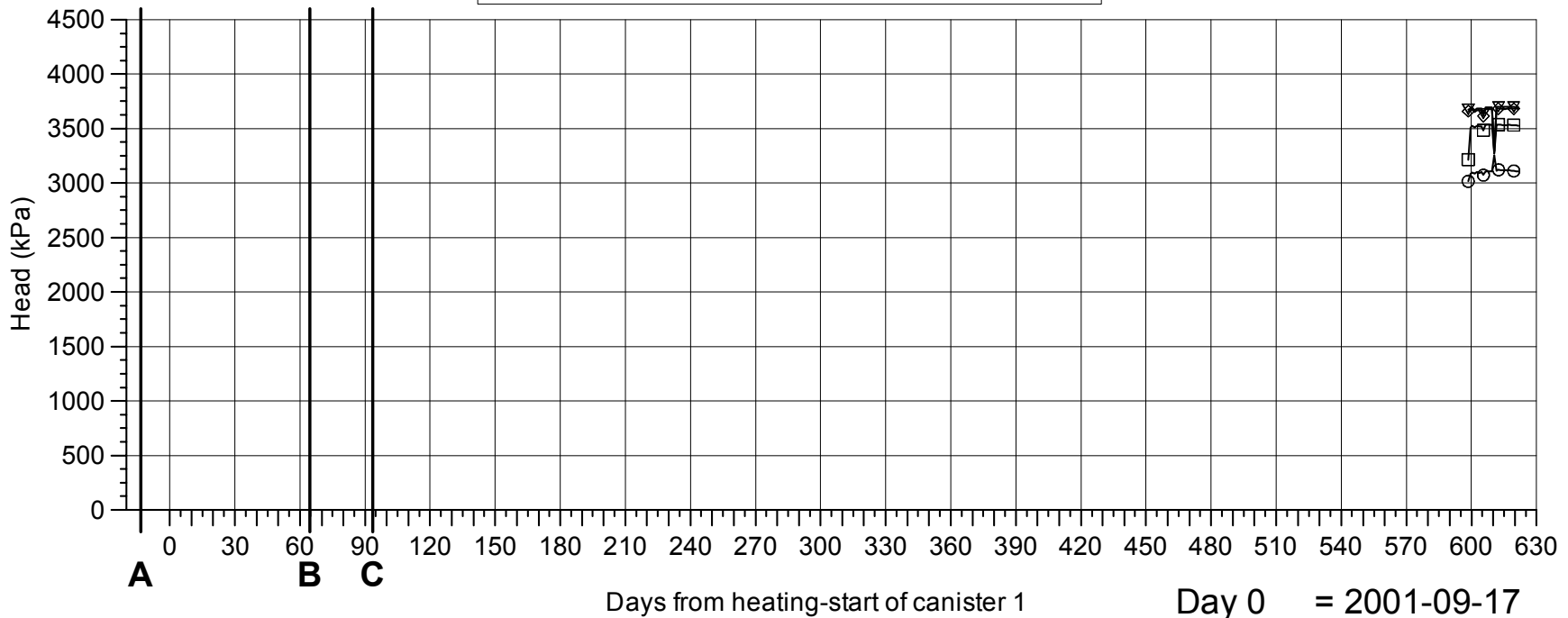

Events

- A - Start backfilling 2001-09-03
- B - Stop backfilling 2001-11-20
- C - Casting inner plug finalized

Borehole sections

- ▽ — A01:1 21.5 m - 30 m
- ◇ — A01:2 11.75 m - 20.5 m
- □ — A01:3 8.8 m - 10.75 m
- ○ — A01:4 3 m - 7.8 m

P_KA3542G01.GRF 2003-06-16

KA3548G01 PRESSURE HEAD

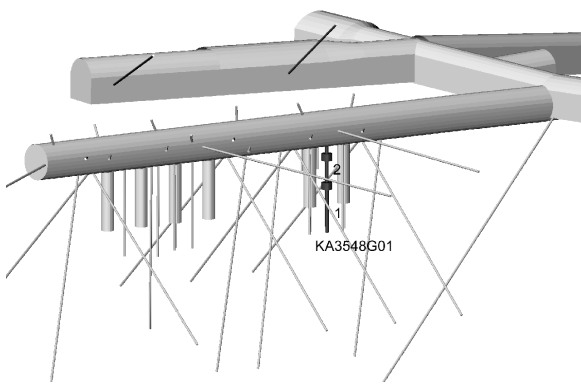
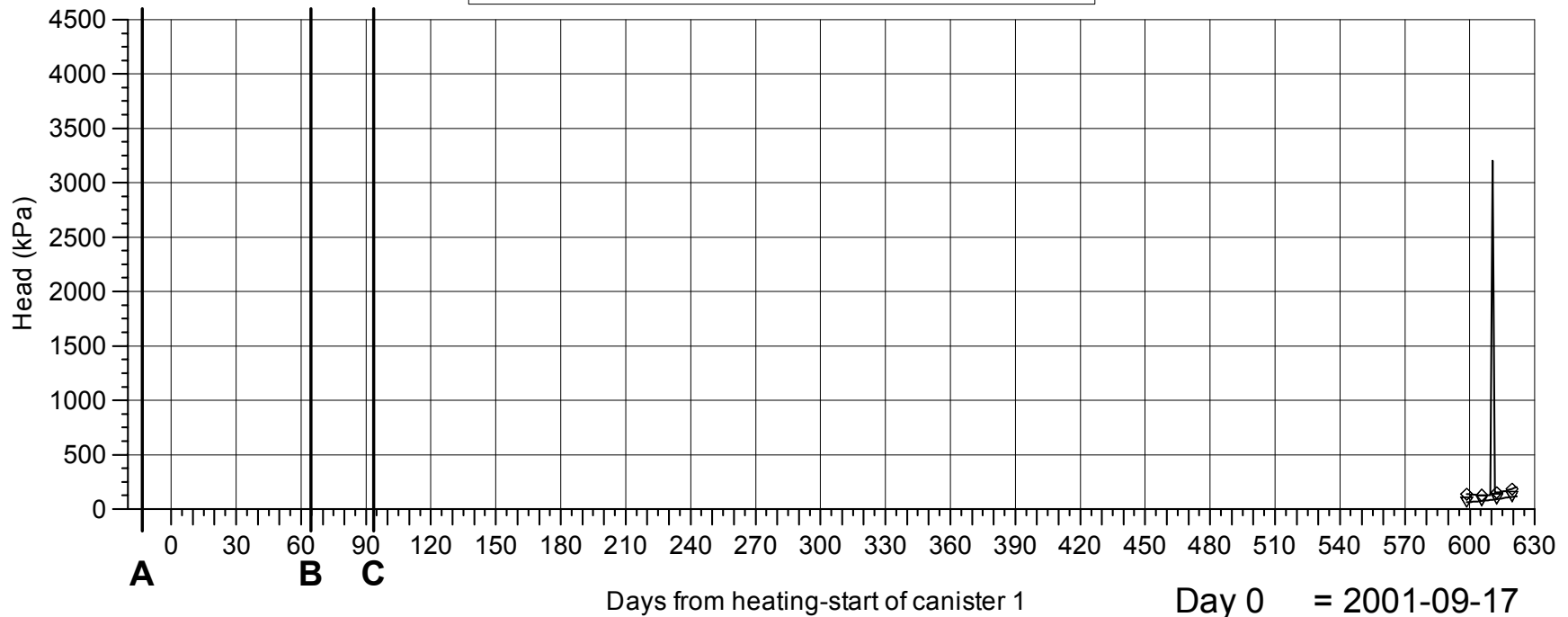

Events

- A - Start backfilling 2001-09-03
- B - Stop backfilling 2001-11-20
- C - Casting inner plug finalized

Borehole sections

- ▽— G01:1 6 m - 12 m
- ◇— G01:2 2 m - 5 m

P_KA3544G01.GRF 2003-06-16

KA3550G01 PRESSURE HEAD

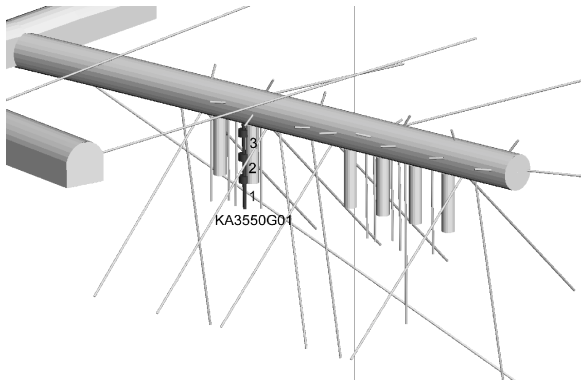
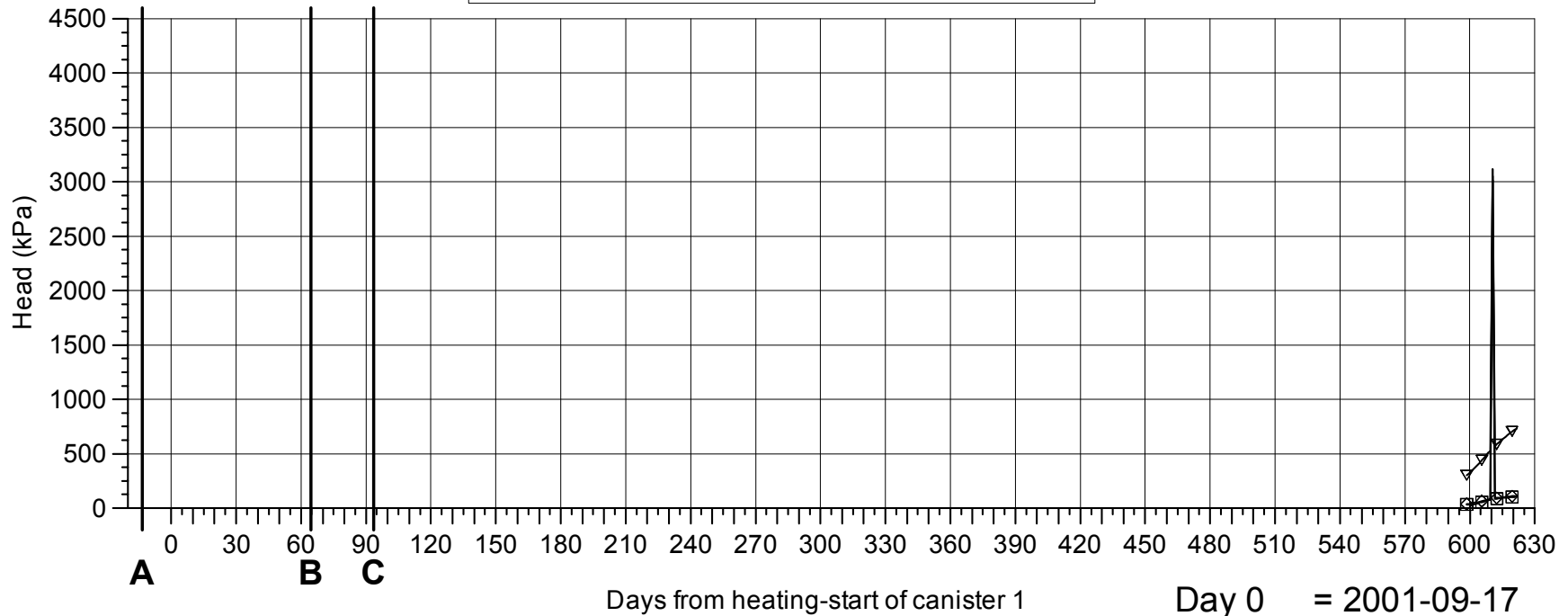

Events

- A - Start backfilling 2001-09-03
- B - Stop backfilling 2001-11-20
- C - Casting inner plug finalized

Borehole sections

- ▽— G01:1 8.3 m - 12.03 m
- ◇— G01:2 5.2 m - 7.3 m
- G01:3 1.8 m - 4.2 m

P_KA3550G01.GRF 2003-06-16

KA3550G05, KA3551G05 PRESSURE HEAD

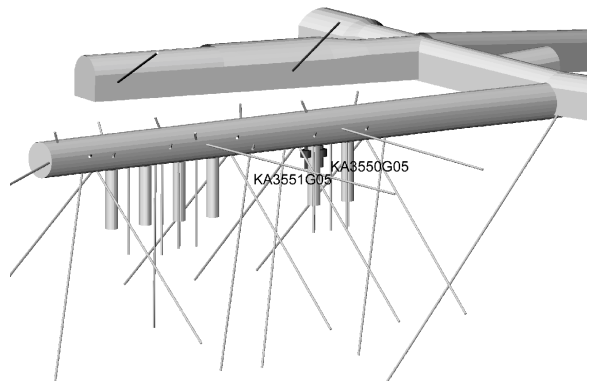
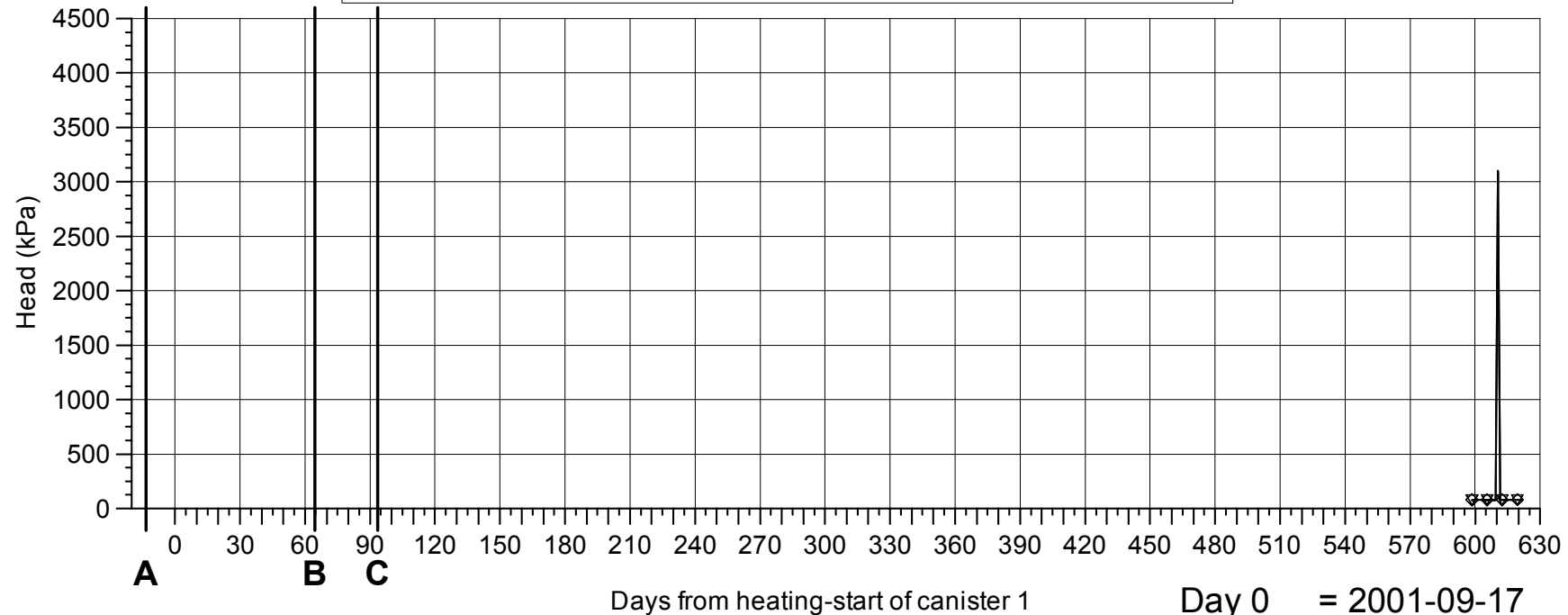

Events

A - Start backfilling 2001-09-03
B - Stop backfilling 2001-11-20
C - Casting inner plug finalized

Borehole sections

—▽— KA3552A01:1 0.65 m - 2 m
—◇— KA3552H01:1 0.65 m - 2 m

KA3552A01, KA3552H01, KA3553B01 PRESSURE HEAD

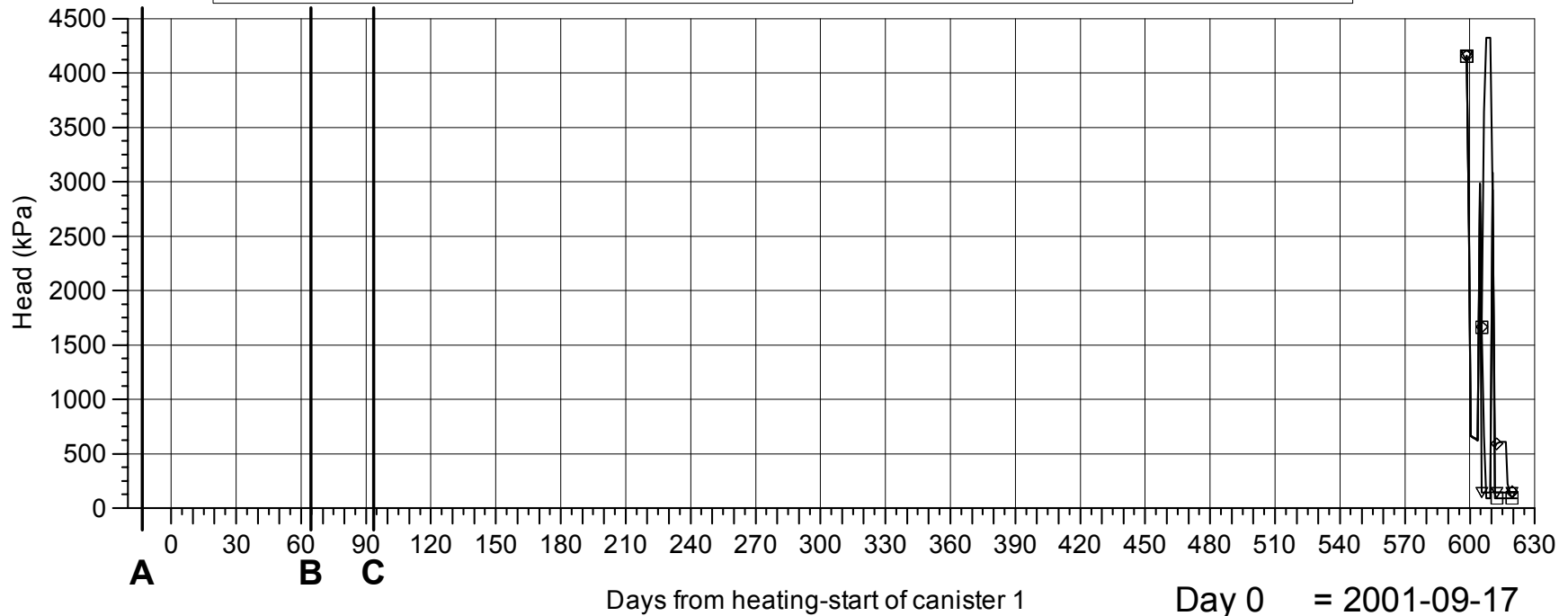

Day 0 = 2001-09-17
 Day 622 = 2003-06-01

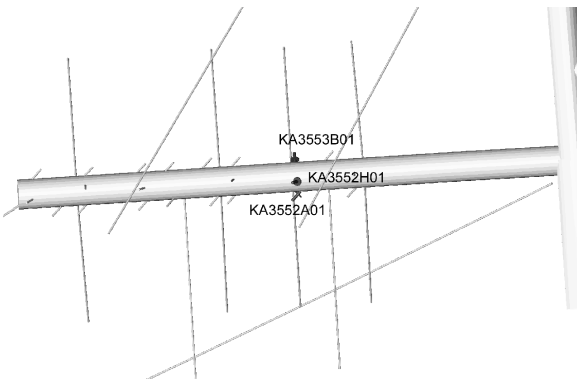

Events

- A - Start backfilling 2001-09-03
- B - Stop backfilling 2001-11-20
- C - Casting inner plug finalized

Borehole sections

- ▽ — KA3552A01:1 0.65 m - 2 m
- ◇ — KA3552H01:1 0.65 m - 2 m
- □ — KA3553B01:1 0.65 m - 2 m

KA3552G01 PRESSURE HEAD

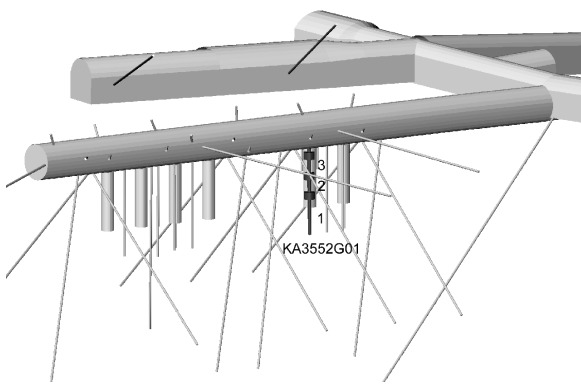
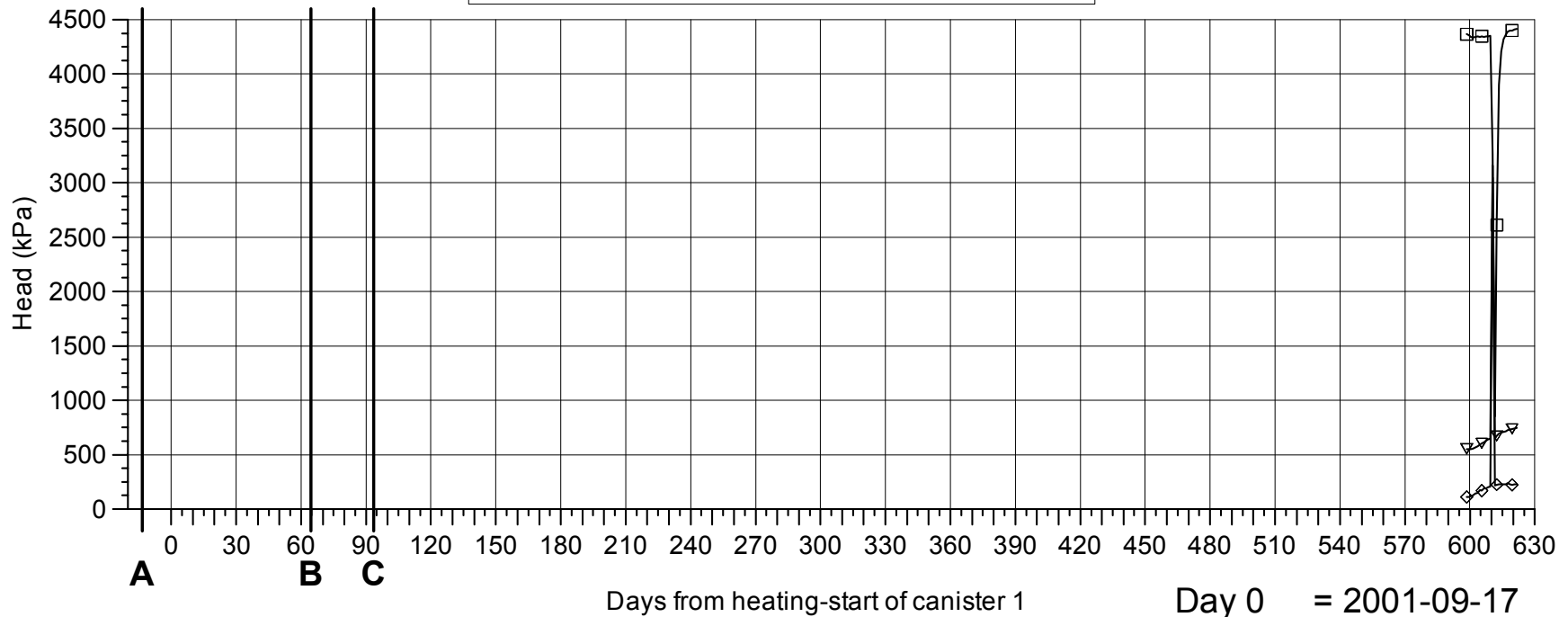

Events

- A - Start backfilling 2001-09-03
- B - Stop backfilling 2001-11-20
- C - Casting inner plug finalized

Borehole sections

- ▽— G01:1 7.05 m - 12 m
- ◇— G01:2 4.35 m - 6.05 m
- G01:3 1.5 m - 3.35 m

P_KA3552G01.GRF 2003-06-16

KA3554G01 PRESSURE HEAD

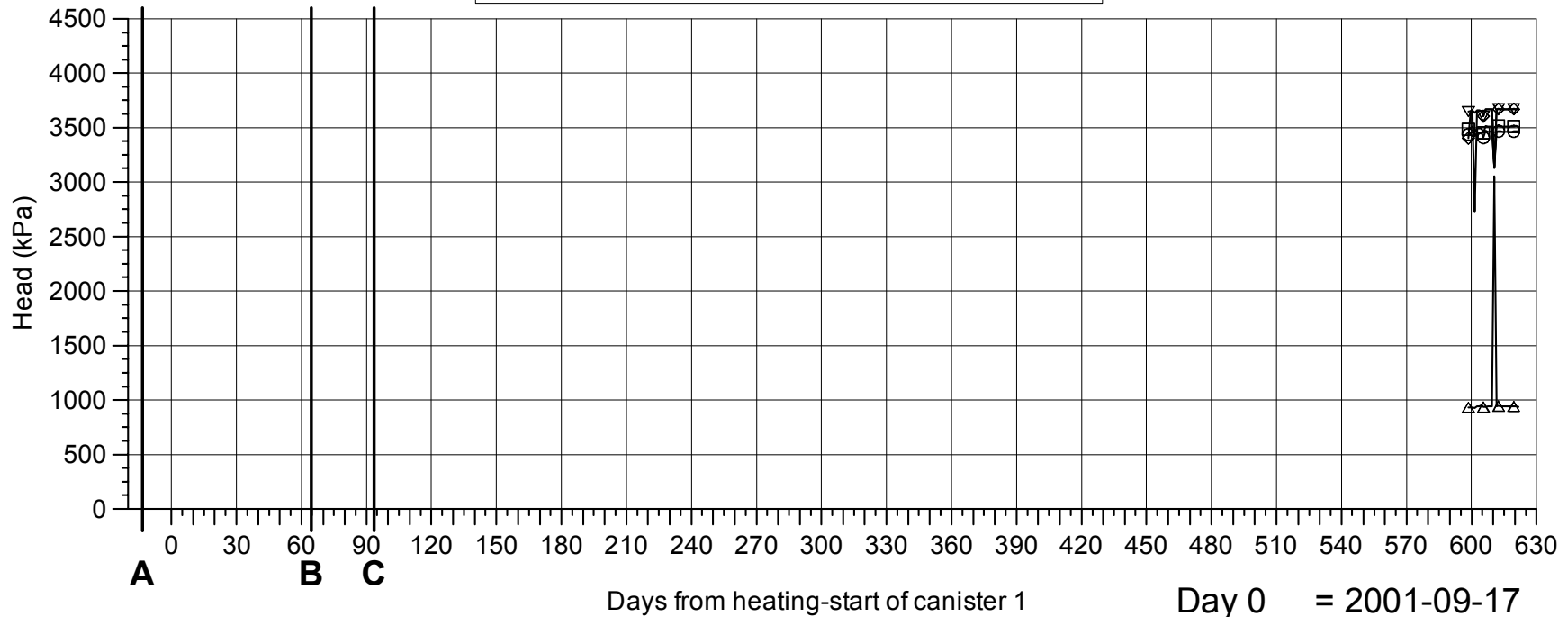

Day 0 = 2001-09-17
 Day 622 = 2003-06-01

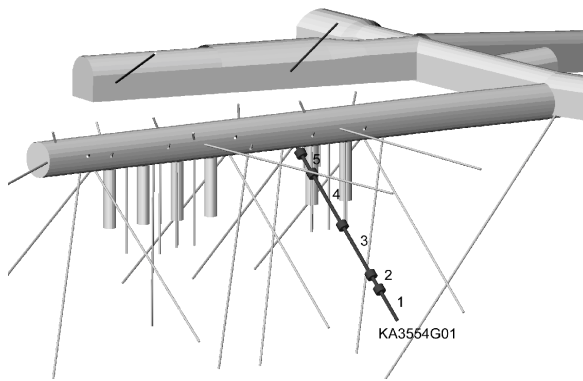

Events

- A - Start backfilling 2001-09-03
- B - Stop backfilling 2001-11-20
- C - Casting inner plug finalized

Borehole sections

- ▽— G01:1 25.15 m - 30.01 m
- ◇— G01:2 22.6 m - 24.15 m
- G01:3 14 m - 21.6 m
- G01:4 5 m - 13 m
- △— G01:5 1.5 m - 4 m

P_KA3554G01.GRF 2003-06-16

KA3554G02 PRESSURE HEAD

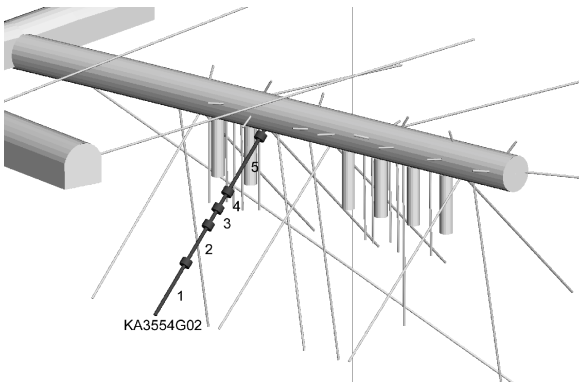
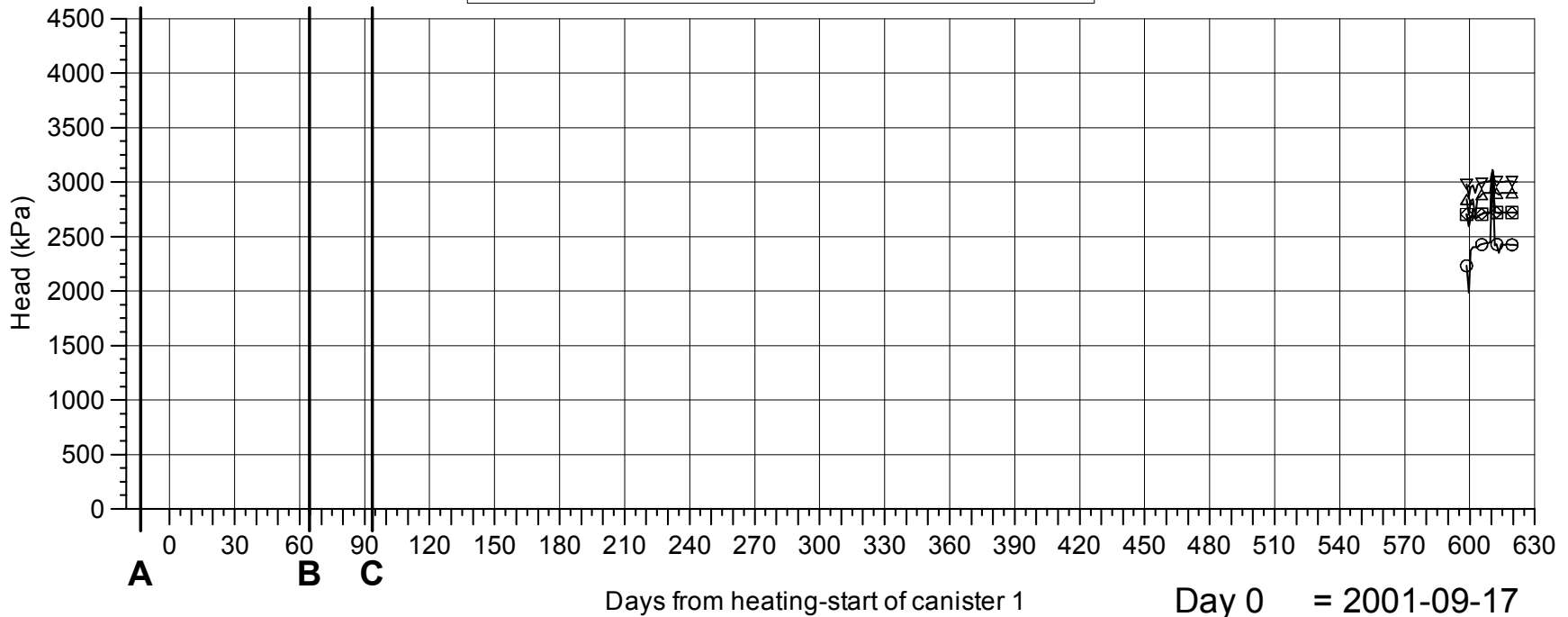

Events

A - Start backfilling 2001-09-03
 B - Stop backfilling 2001-11-20
 C - Casting inner plug finalized

Borehole sections

—▽— G02:1 22 m - 30.01 m
 —◇— G02:2 15.9 m - 21 m
 —□— G02:3 13.2 m - 14.9 m
 —○— G02:4 10.5 m - 12.2 m
 —△— G02:5 1.5 m - 9.5 m

KA3557G PRESSURE HEAD

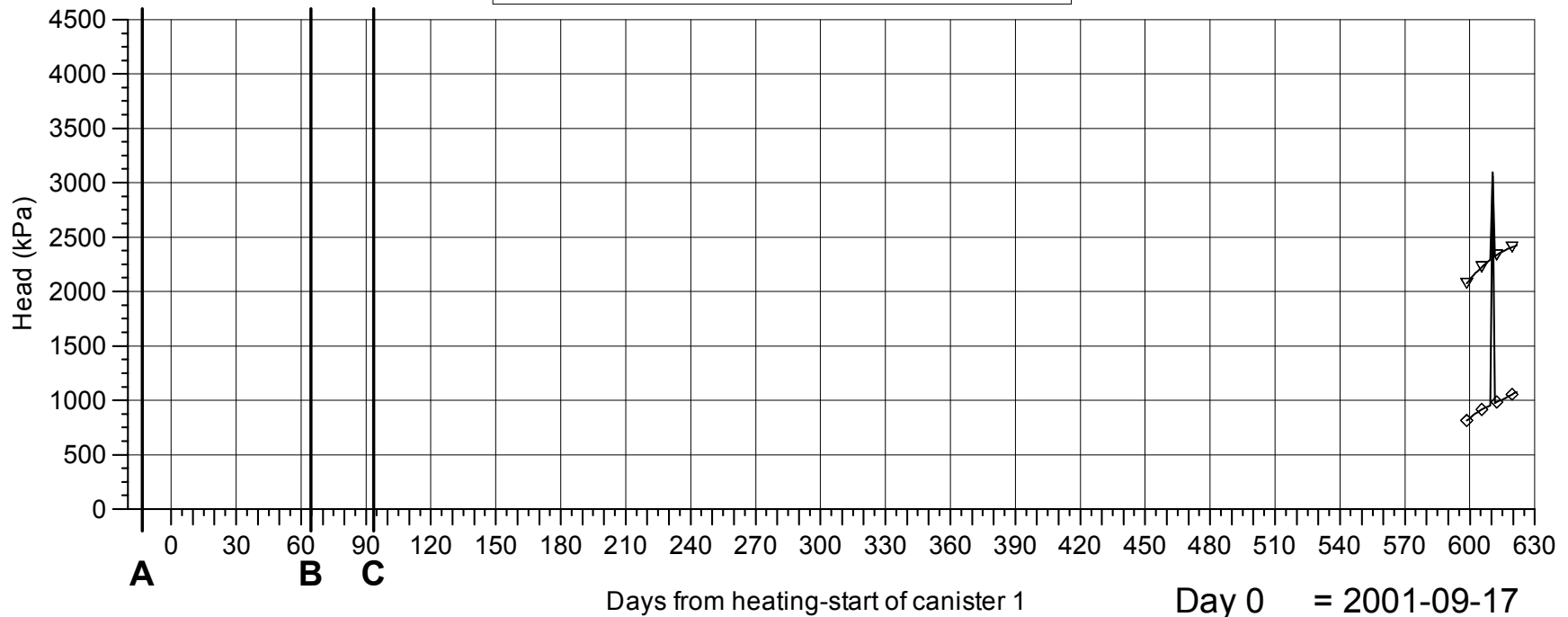

Day 0 = 2001-09-17
 Day 622 = 2003-06-01

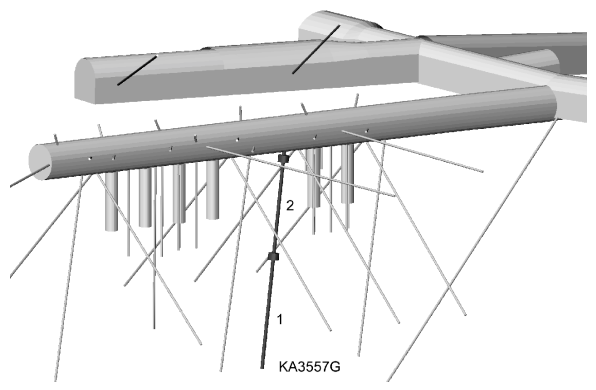

Events

- A - Start backfilling 2001-09-03
- B - Stop backfilling 2001-11-20
- C - Casting inner plug finalized

Borehole sections

- ▽— G:1 15 m - 30.04 m
- ◇— G:2 1.5 m - 14 m

KA3563G PRESSURE HEAD

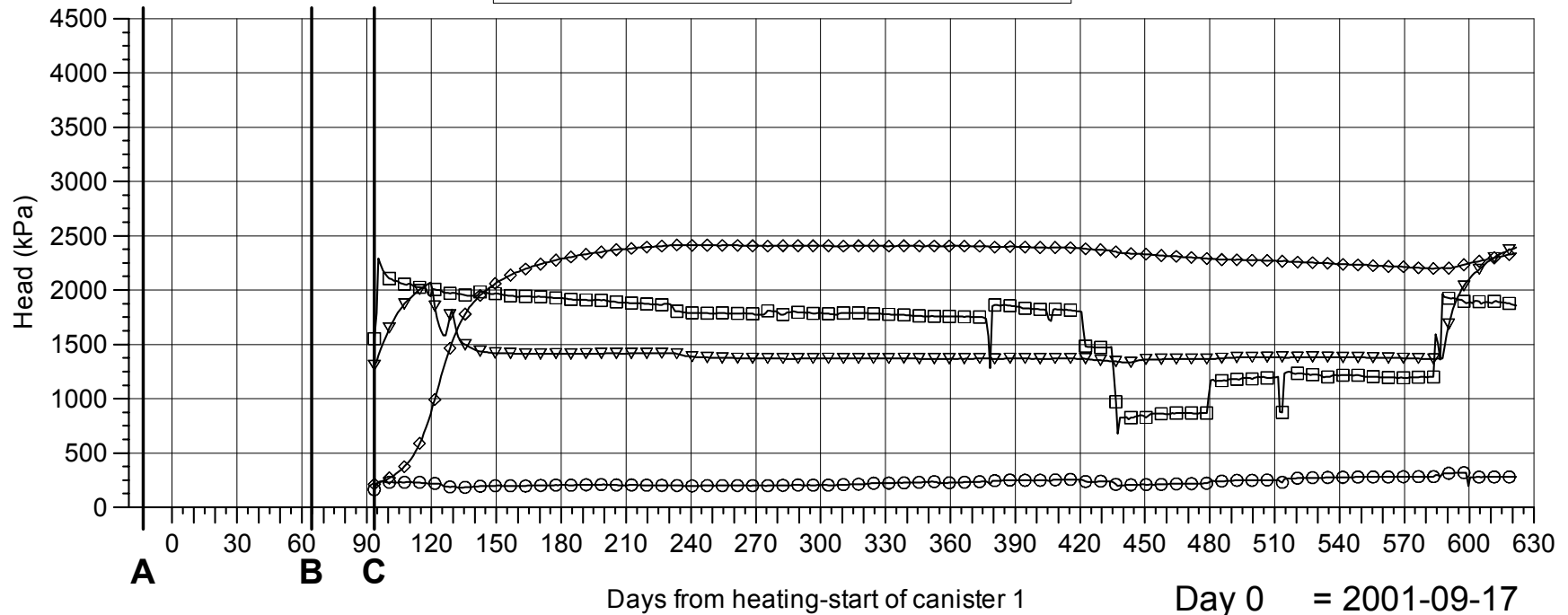

Day 0 = 2001-09-17
 Day 622 = 2003-06-01

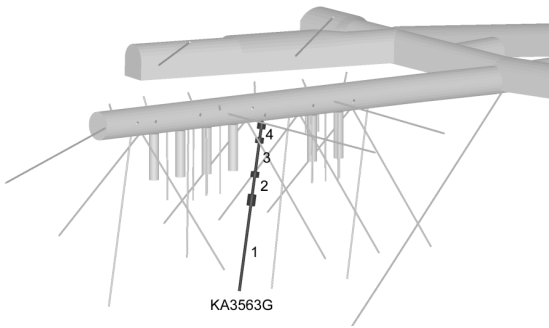

Events

- A - Start backfilling 2001-09-03
- B - Stop backfilling 2001-11-20
- C - Casting inner plug finalized

Borehole sections

- ▽— G:1 15 m - 30 m
- ◇— G:2 10 m - 13 m
- G:3 4 m - 8 m
- G:4 1.5 m - 3 m

KA3563A01, KA3563D01, KA3563I01 PRESSURE HEAD

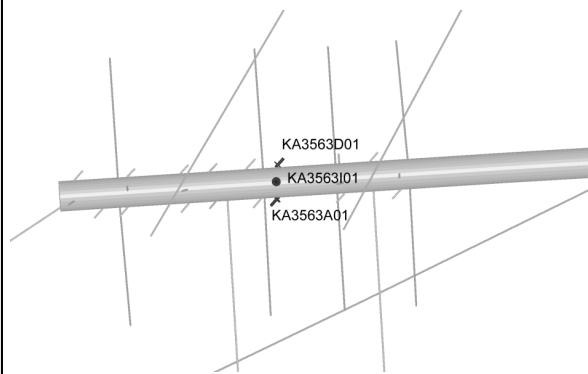
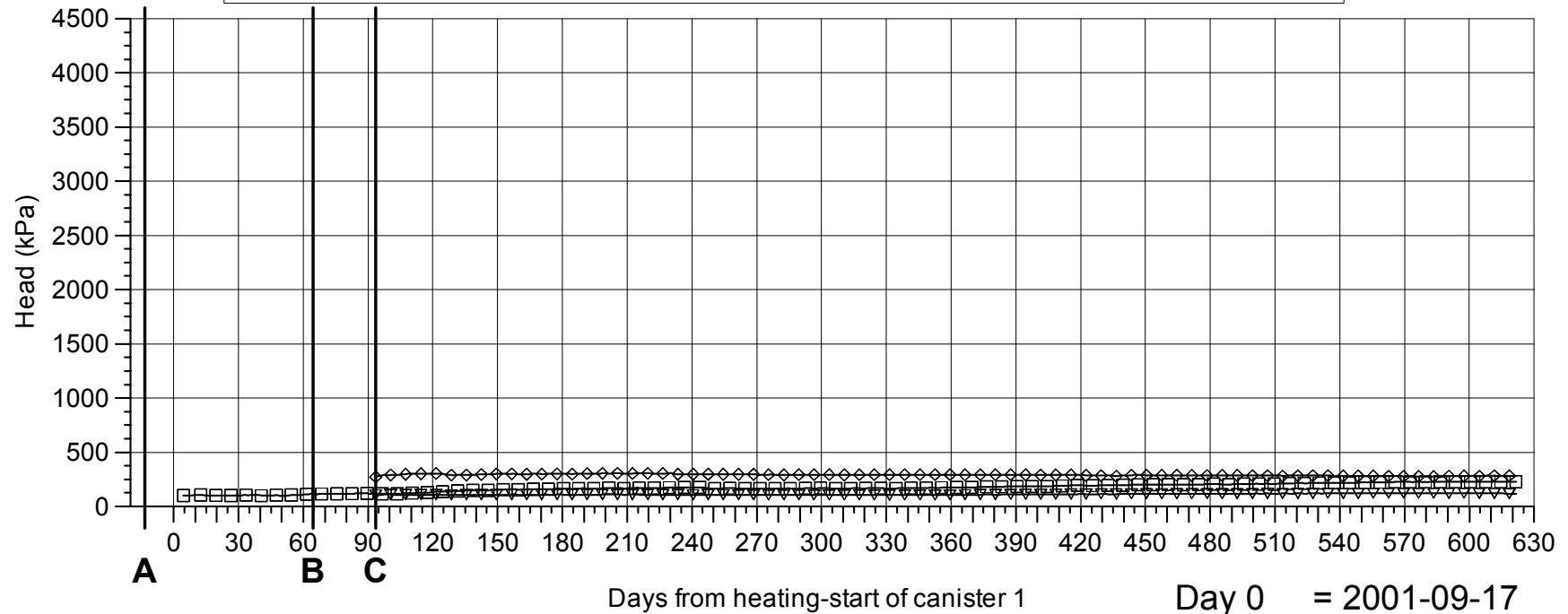

Events	Borehole sections
A - Start backfilling 2001-09-03	—▽— KA3563A01:1 0.65 m - 2 m
B - Stop backfilling 2001-11-20	—◇— KA3563D01:1 0.65 m - 2 m
C - Casting inner plug finalized	—□— KA3563I01:1 0.65 m - 2 m

KA3566G01 PRESSURE HEAD

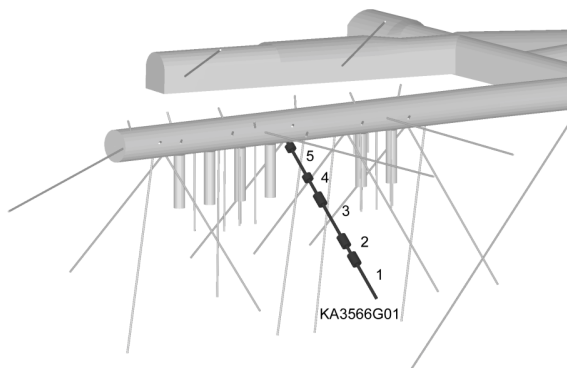
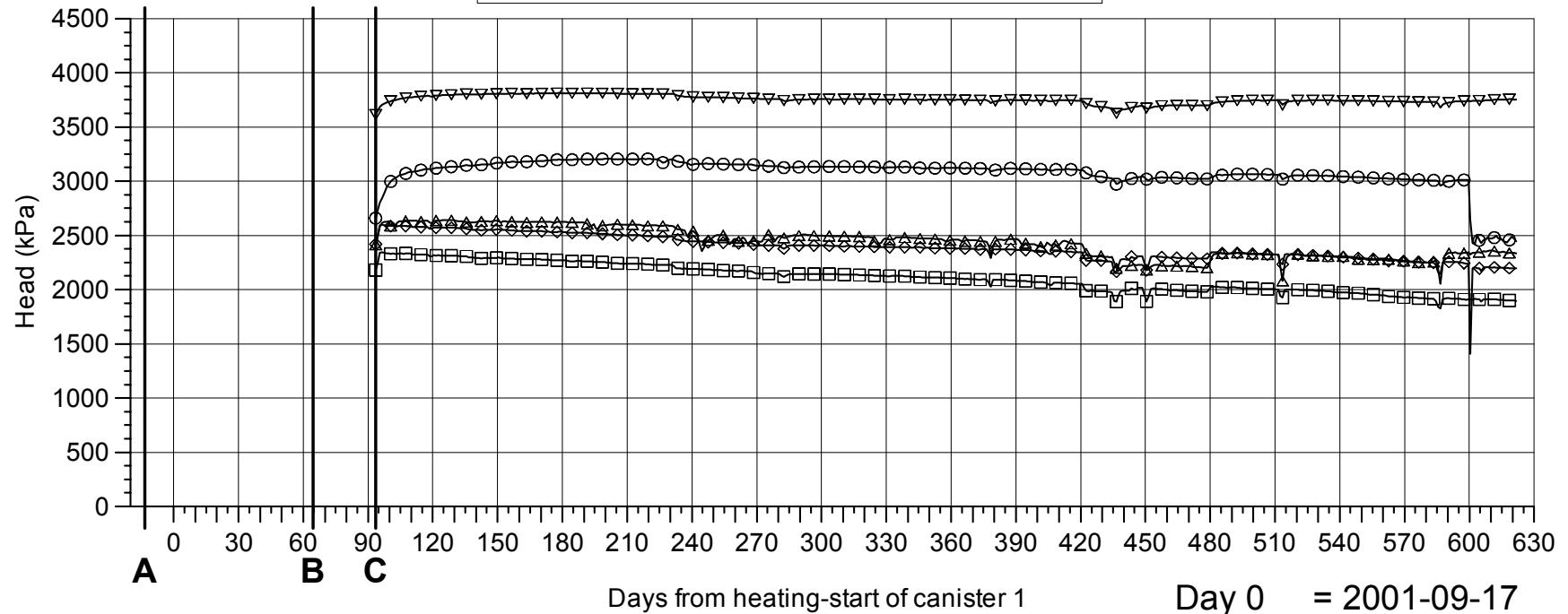

Events

A - Start backfilling 2001-09-03
 B - Stop backfilling 2001-11-20
 C - Casting inner plug finalized

Borehole sections

—▽— G01:1 23.5 m - 30 m
 —◇— G01:2 20 m - 21.5 m
 —□— G01:3 12 m - 18 m
 —○— G01:4 7.3 m - 10 m
 —△— G01:5 1.5 m - 6.3 m

KA3566G02 PRESSURE HEAD

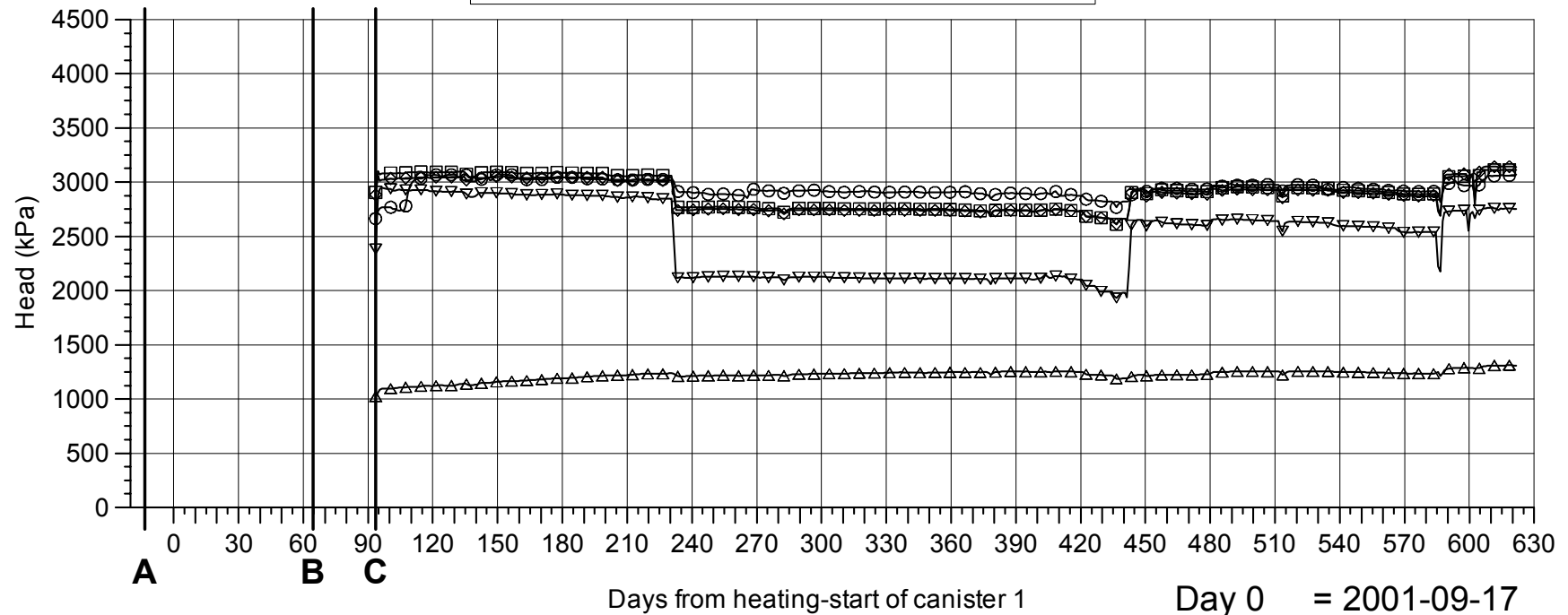

Day 0 = 2001-09-17
 Day 622 = 2003-06-01

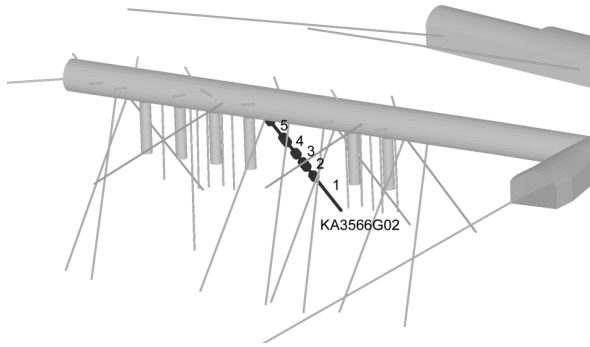

Events

A - Start backfilling 2001-09-03
 B - Stop backfilling 2001-11-20
 C - Casting inner plug finalized

Borehole sections

—▽— G02:1 19 m - 30 m
 —◇— G02:2 16 m - 18 m
 —□— G02:3 12 m - 14 m
 —○— G02:4 8 m - 11 m
 —△— G02:5 1.5 m - 6 m

KA3566C01, KA3568D01, KA3573C01, KA3574D01 PRESSURE HEAD

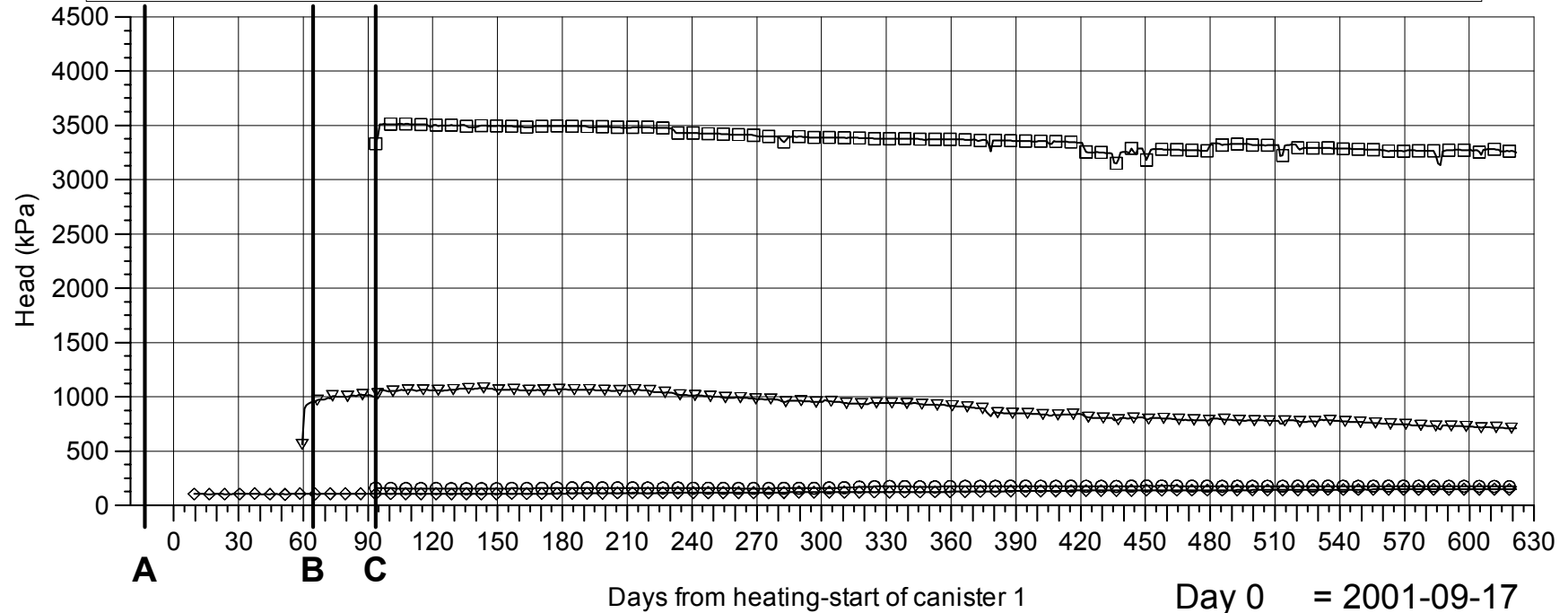

Day 0 = 2001-09-17
 Day 622 = 2003-06-01

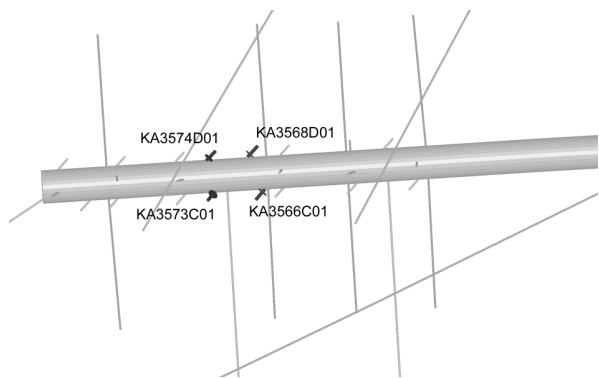

Events

A - Start backfilling 2001-09-03
 B - Stop backfilling 2001-11-20
 C - Casting inner plug finalized

Borehole sections

—▽— KA3566C01:1 0.65 m - 2 m
 —◇— KA3568D01:1 0.65 m - 2 m
 —□— KA3573C01:1 0.65 m - 2 m
 —○— KA3574D01:1 0.65 m - 2 m

KA3572G01 PRESSURE HEAD

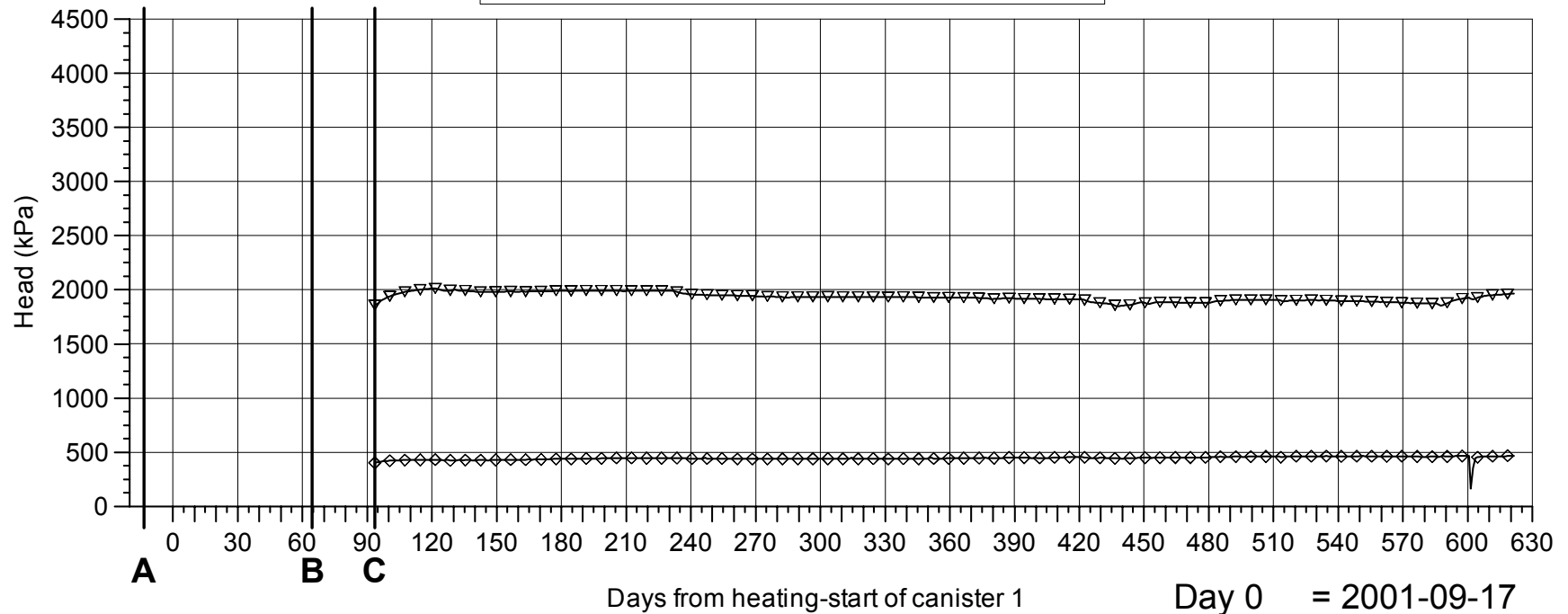

Day 0 = 2001-09-17
 Day 622 = 2003-06-01

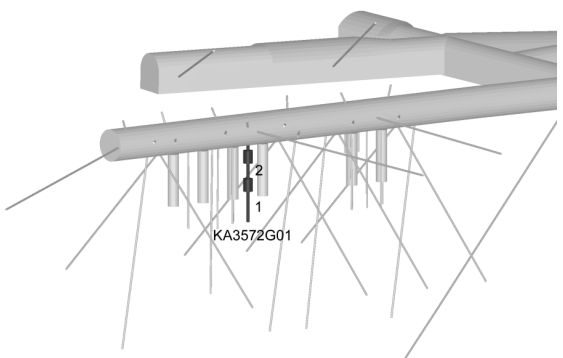

- Events**
- A - Start backfilling 2001-09-03
 - B - Stop backfilling 2001-11-20
 - C - Casting inner plug finalized

- Borehole sections**
- ▽— G01:1 7.3 m - 12.0 m
 - ◇— G01:2 2.7 m - 5.3 m

KA3573A PRESSURE HEAD

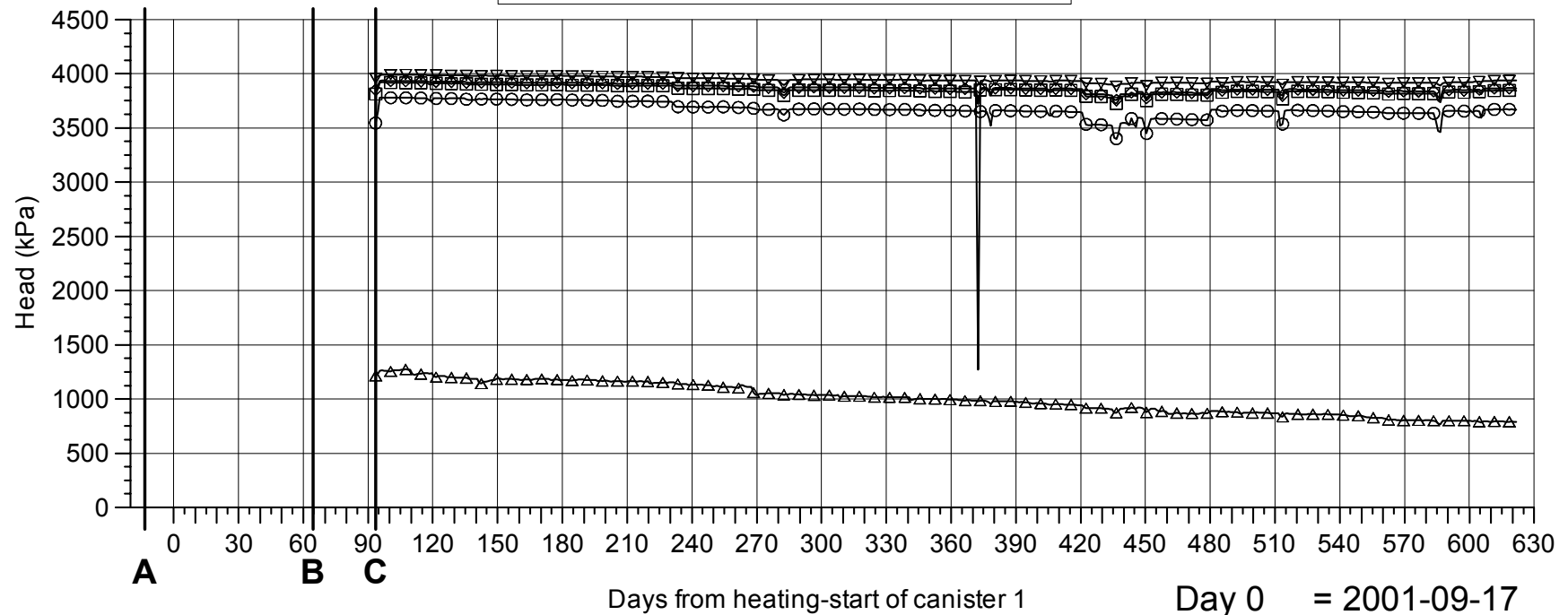

Day 0 = 2001-09-17
Day 622 = 2003-06-01

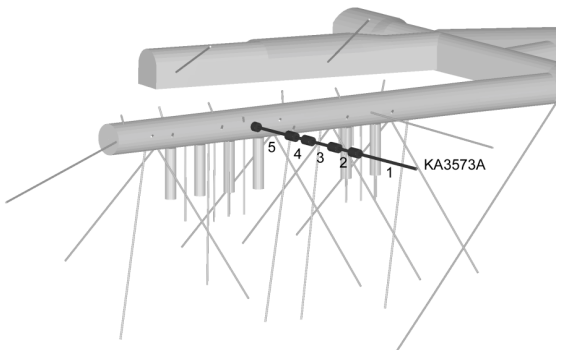

Events

A - Start backfilling 2001-09-03
B - Stop backfilling 2001-11-20
C - Casting inner plug finalized

Borehole sections

—▽— A:1 26 m - 40.1 m
—◇— A:2 21 m - 24 m
—□— A:3 14.5 m - 19 m
—○— A:4 10.5 m - 12.5 m
—△— A:5 3.4 m - 8.5 m

KA3574G01 PRESSURE HEAD

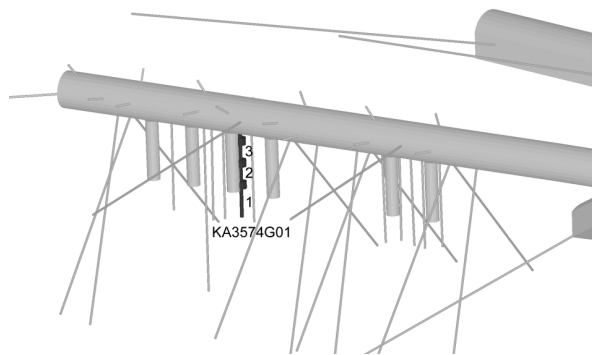
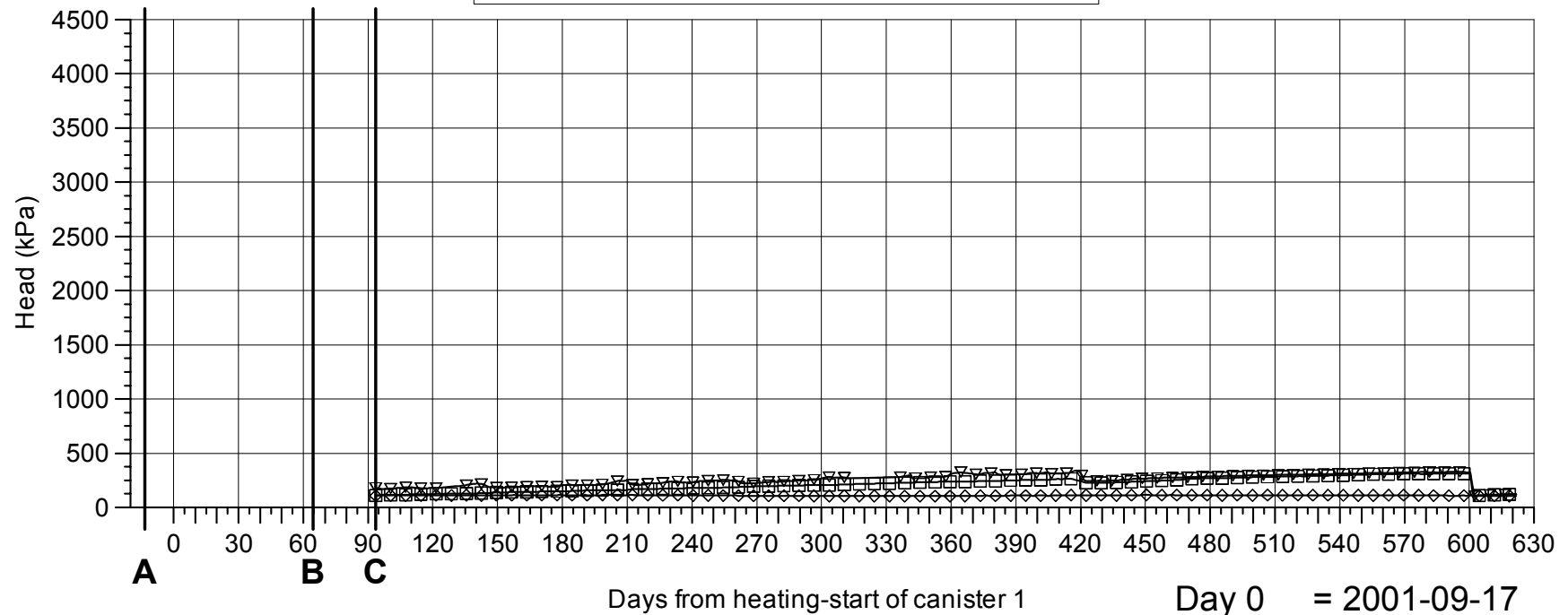

Events

A - Start backfilling 2001-09-03
 B - Stop backfilling 2001-11-20
 C - Casting inner plug finalized

Borehole sections

—▽— G01:1 8 m - 12 m
 —◇— G01:2 5.1 m - 7 m
 —□— G01:3 1.8 m - 4.1 m

KA3576G01 PRESSURE HEAD

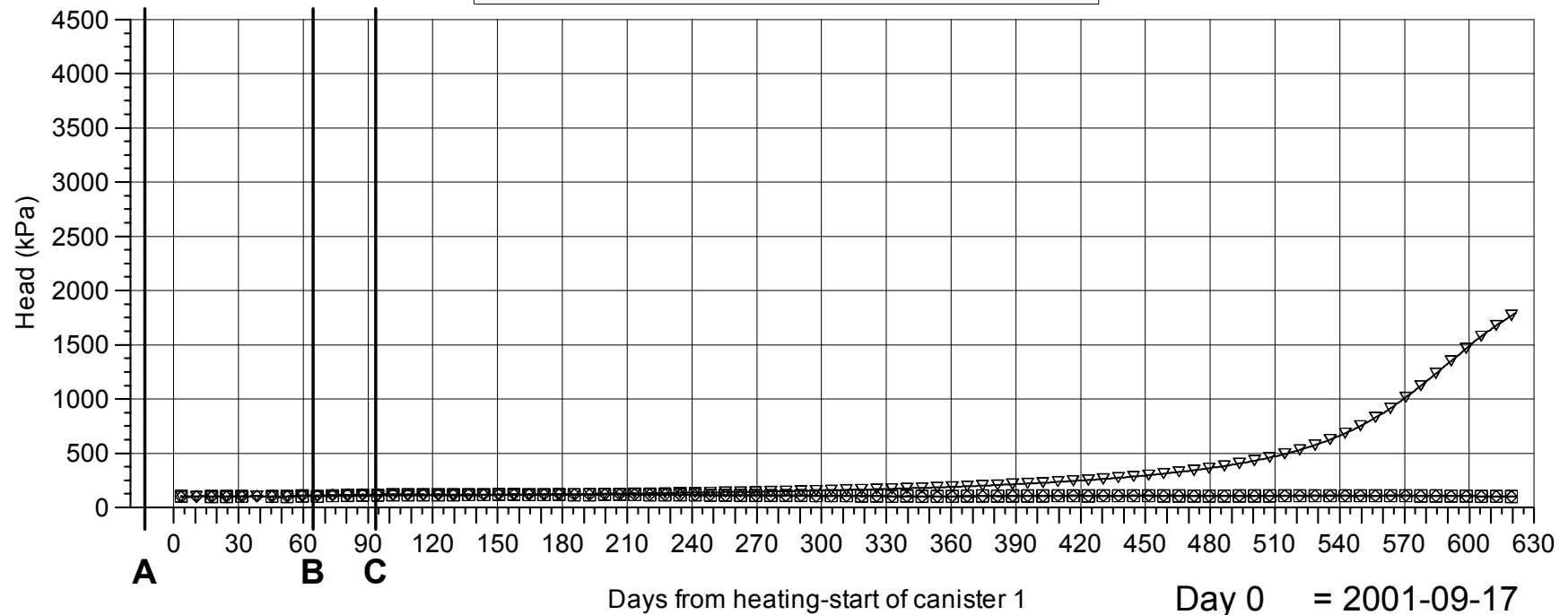

Day 0 = 2001-09-17
 Day 530 = 2003-03-01

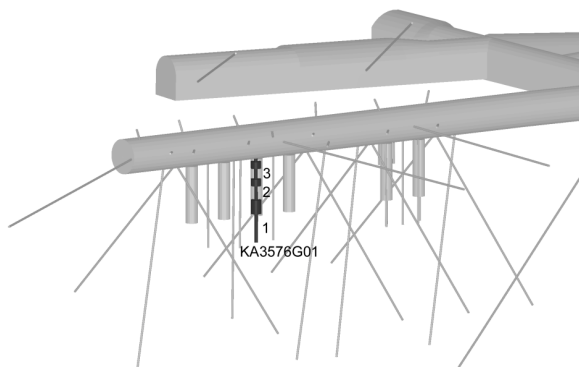

Events

- A - Start backfilling 2001-09-03
- B - Stop backfilling 2001-11-20
- C - Casting inner plug finalized

Borehole sections

- ▽— G01:1 7.9 m - 12 m
- ◇— G01:2 3.9 m - 5.9 m
- G01:3 1.4 m - 2.9 m

KA3578G01 PRESSURE HEAD

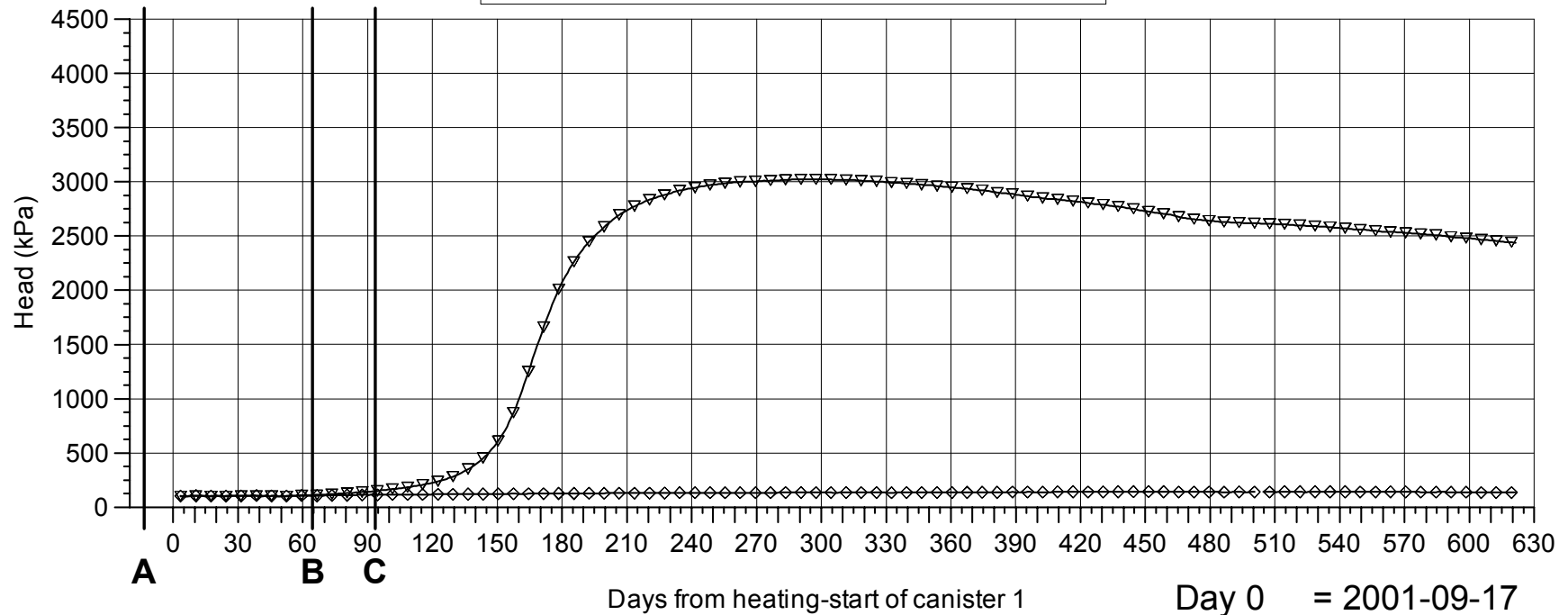

Day 0 = 2001-09-17
 Day 622 = 2003-06-01

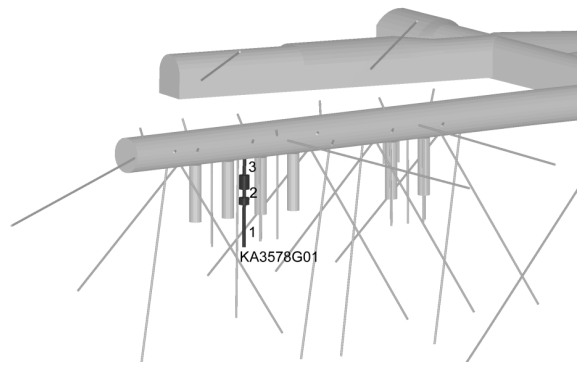

- Events**
- A - Start backfilling 2001-09-03
 - B - Stop backfilling 2001-11-20
 - C - Casting inner plug finalized

- Borehole sections**
- ▽— G01:1 6.5 m - 12.6 m
 - ◇— G01:2 4.3 m - 5.5 m

KA3578C01, KA3578H01, KA3579D01 PRESSURE HEAD

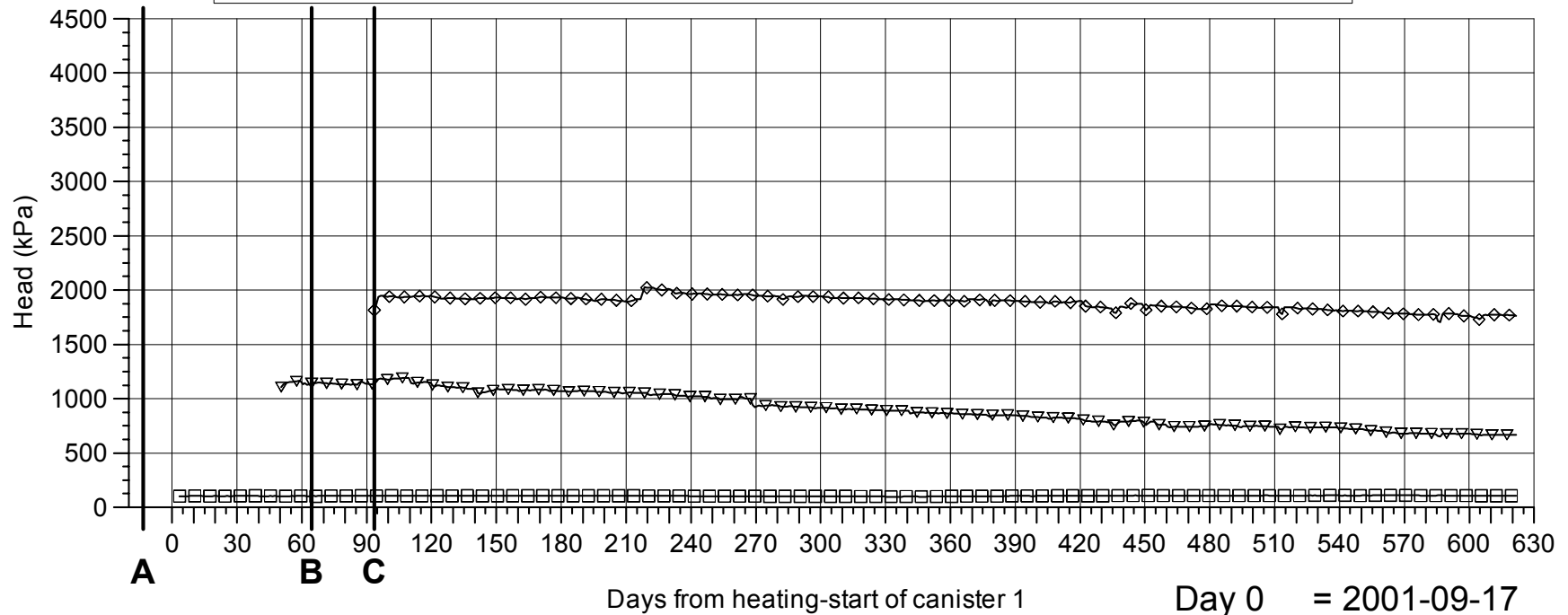

Day 0 = 2001-09-17
 Day 622 = 2003-06-01

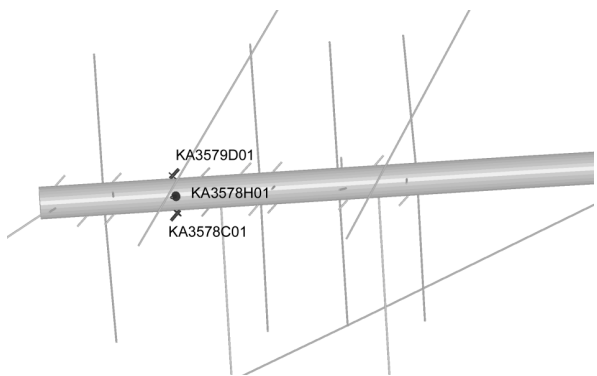

Events

A - Start backfilling 2001-09-03
 B - Stop backfilling 2001-11-20
 C - Casting inner plug finalized

Borehole sections

—▽— KA3578C01:1 0.65 m - 2 m
 —◇— KA3578H01:1 0.65 m - 2 m
 —□— KA3579D01:1 0.65 m - 2 m

KA3579G PRESSURE HEAD

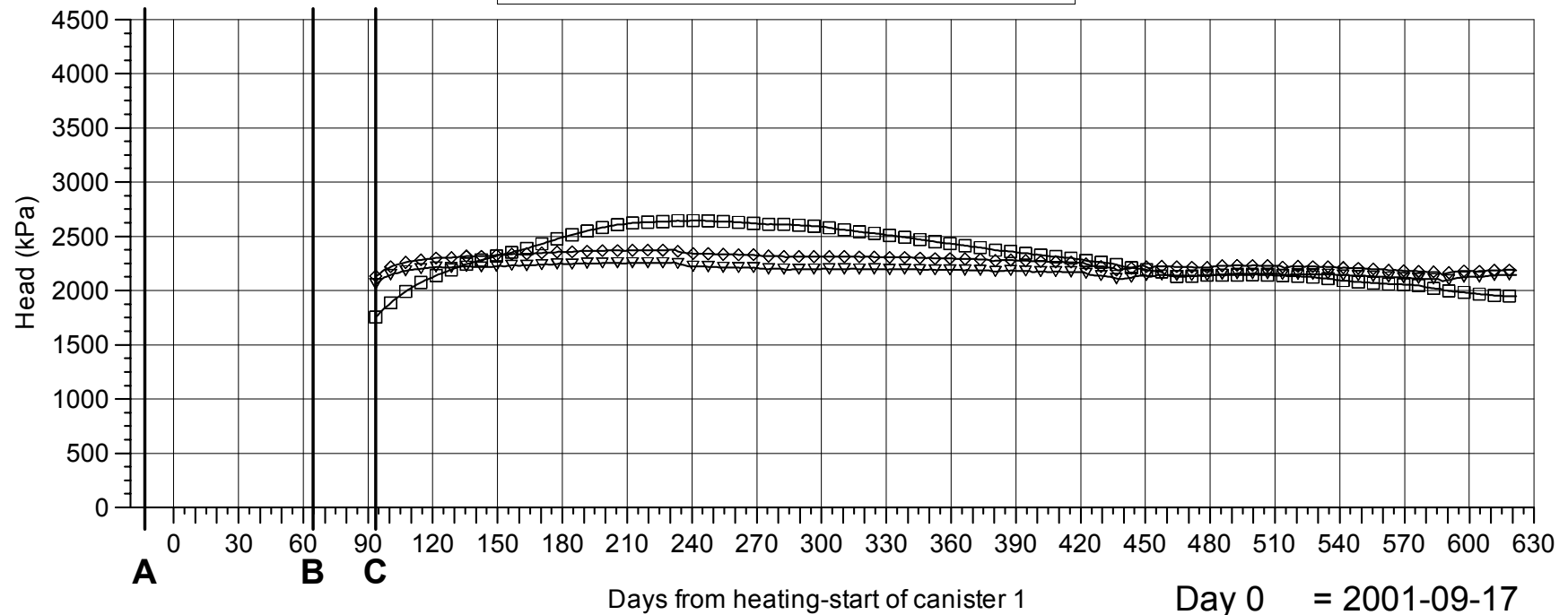

Day 0 = 2001-09-17
 Day 622 = 2003-06-01

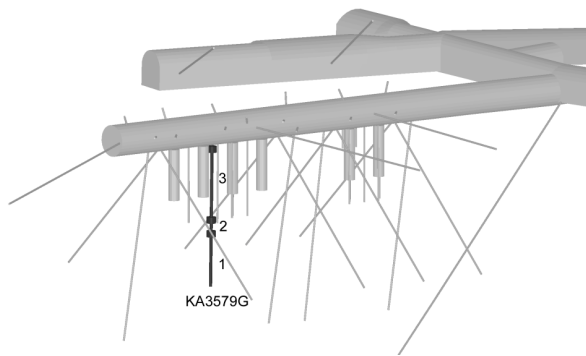

Events

- A - Start backfilling 2001-09-03
- B - Stop backfilling 2001-11-20
- C - Casting inner plug finalized

Borehole sections

- ▽— G:1 14.7 m - 22.7 m
- ◇— G:2 12.5 m - 13.7 m
- G:3 2.5 m - 11.5 m

KA3584G01 PRESSURE HEAD

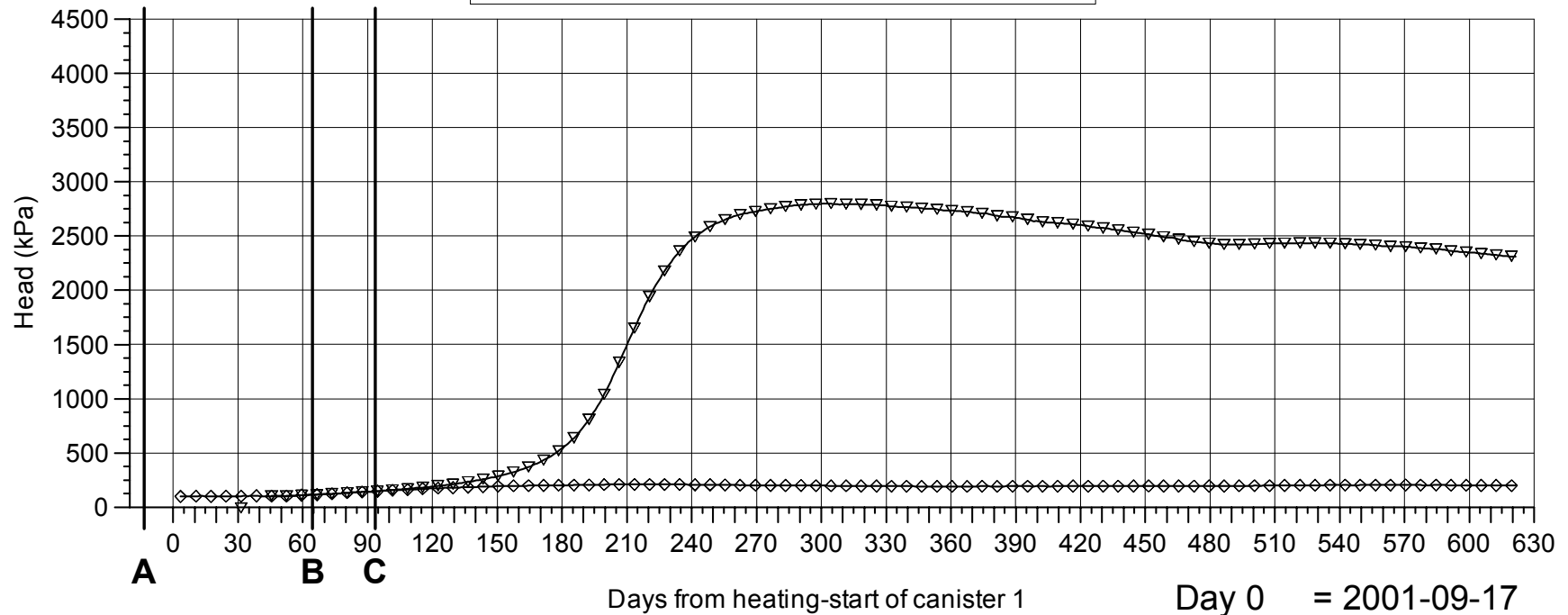

Day 0 = 2001-09-17
 Day 622 = 2003-06-01

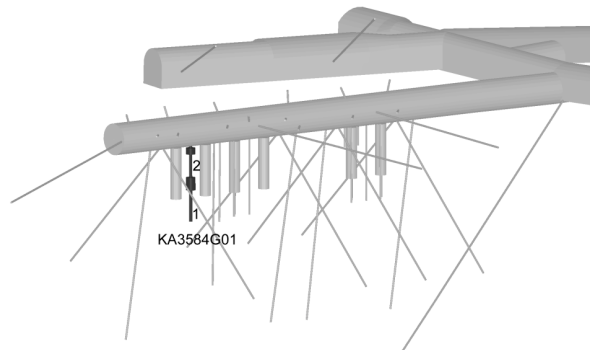

- Events**
- A - Start backfilling 2001-09-03
 - B - Stop backfilling 2001-11-20
 - C - Casting inner plug finalized

- Borehole sections**
- ▽— G01:1 7 m - 12 m
 - ◇— G01:2 1.4 m - 5 m

KA3588C01, KA3588D01, KA3588I01 PRESSURE HEAD

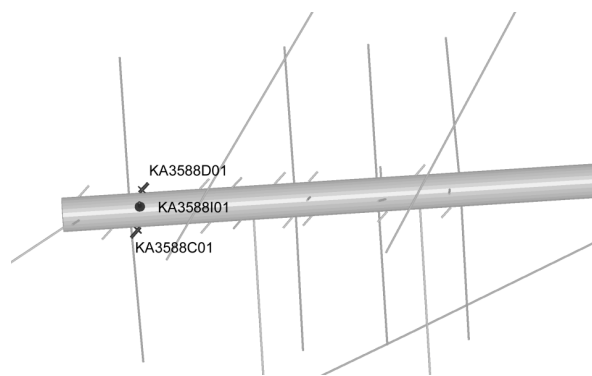
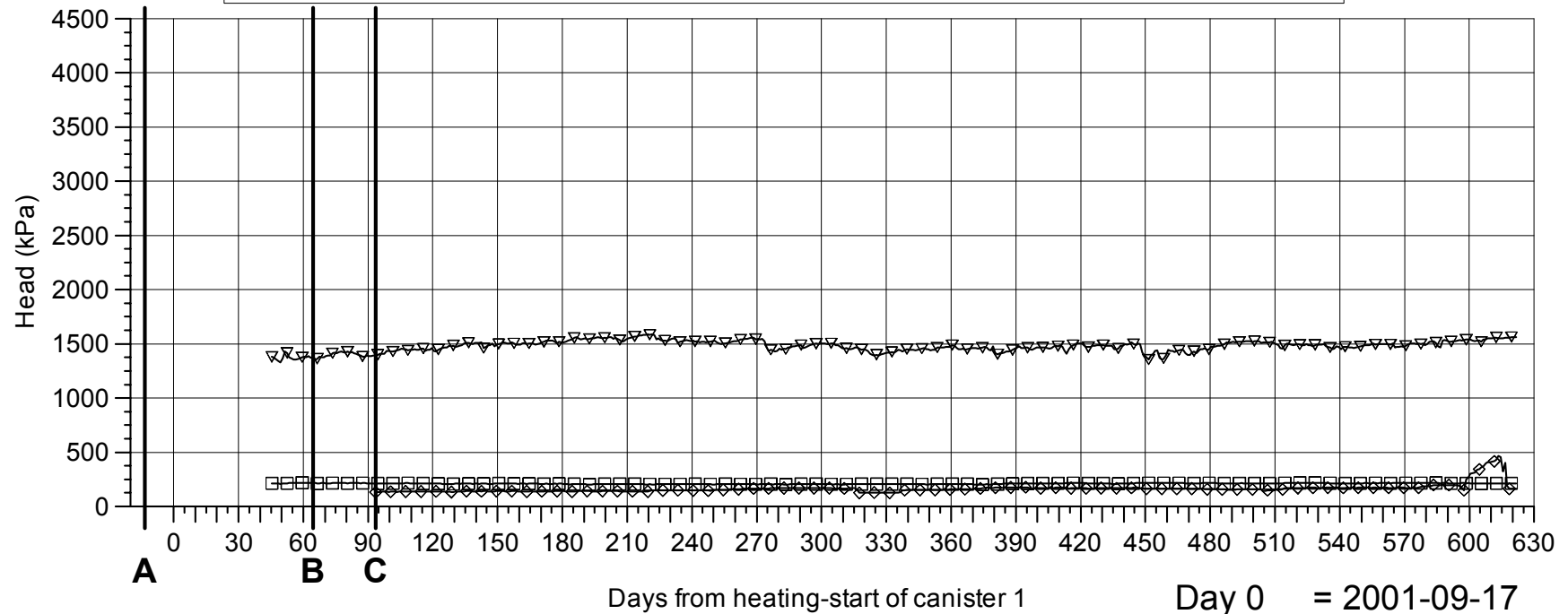

Events

A - Start backfilling 2001-09-03
 B - Stop backfilling 2001-11-20
 C - Casting inner plug finalized

Borehole sections

—▽— KA3588C01:1 0.65 m - 2 m
 —◇— KA3588D01:1 0.65 m - 2 m
 —□— KA3588I01:1 0.65 m - 2 m

KA3590G01 PRESSURE HEAD

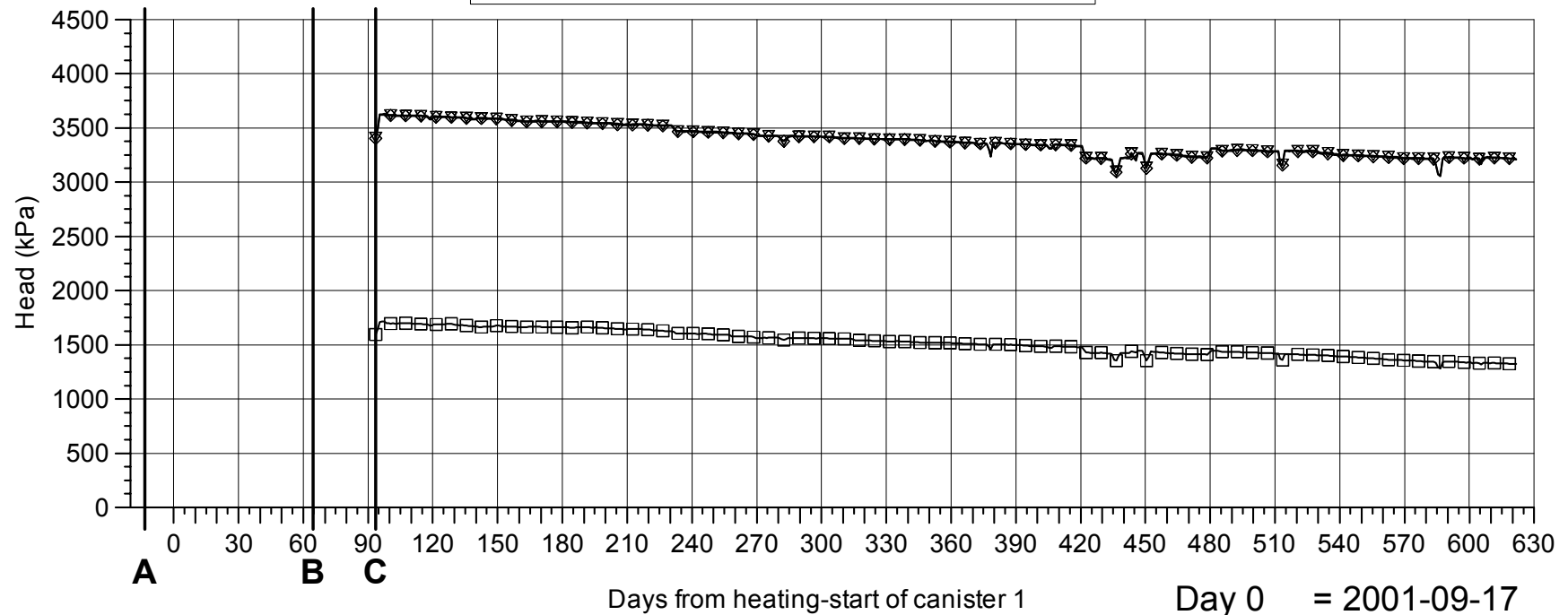

Day 0 = 2001-09-17
Day 622 = 2003-06-01

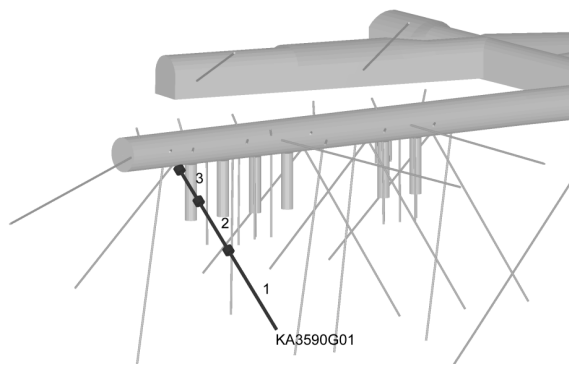

Events

- A - Start backfilling 2001-09-03
- B - Stop backfilling 2001-11-20
- C - Casting inner plug finalized

Borehole sections

- ▽— G01:1 16 m - 30 m
- ◇— G01:2 7 m - 15 m
- G01:3 1.5 m - 6 m

KA3590G02 PRESSURE HEAD

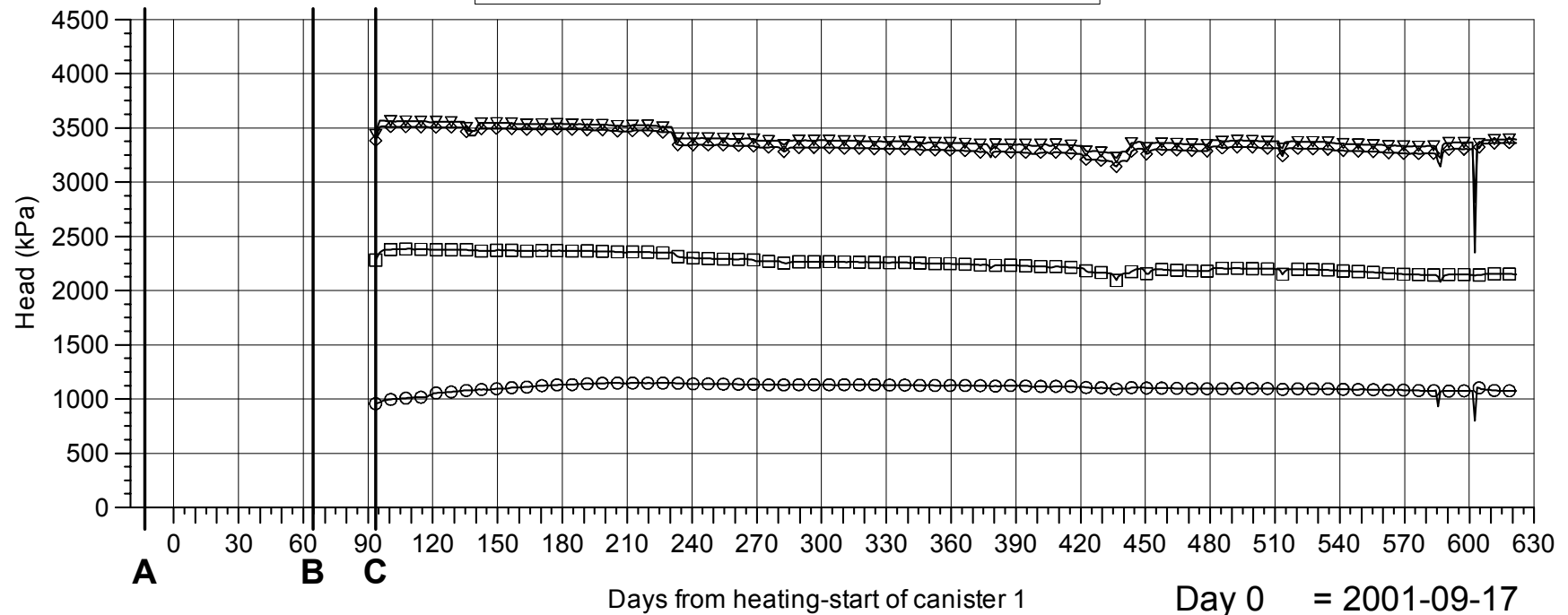

Day 0 = 2001-09-17
Day 622 = 2003-06-01

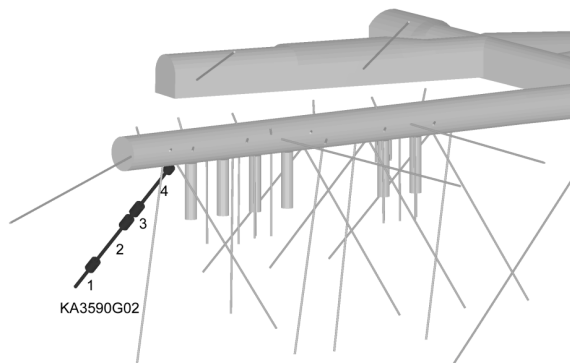

Events

A - Start backfilling 2001-09-03
B - Stop backfilling 2001-11-20
C - Casting inner plug finalized

Borehole sections

—▽— G02:1 25.65 m - 30 m
—◇— G02:2 15.35 m - 23.65 m
—□— G02:3 12.05 m - 13.35 m
—○— G02:4 1.65 m - 10.05 m

KA3593G PRESSURE HEAD

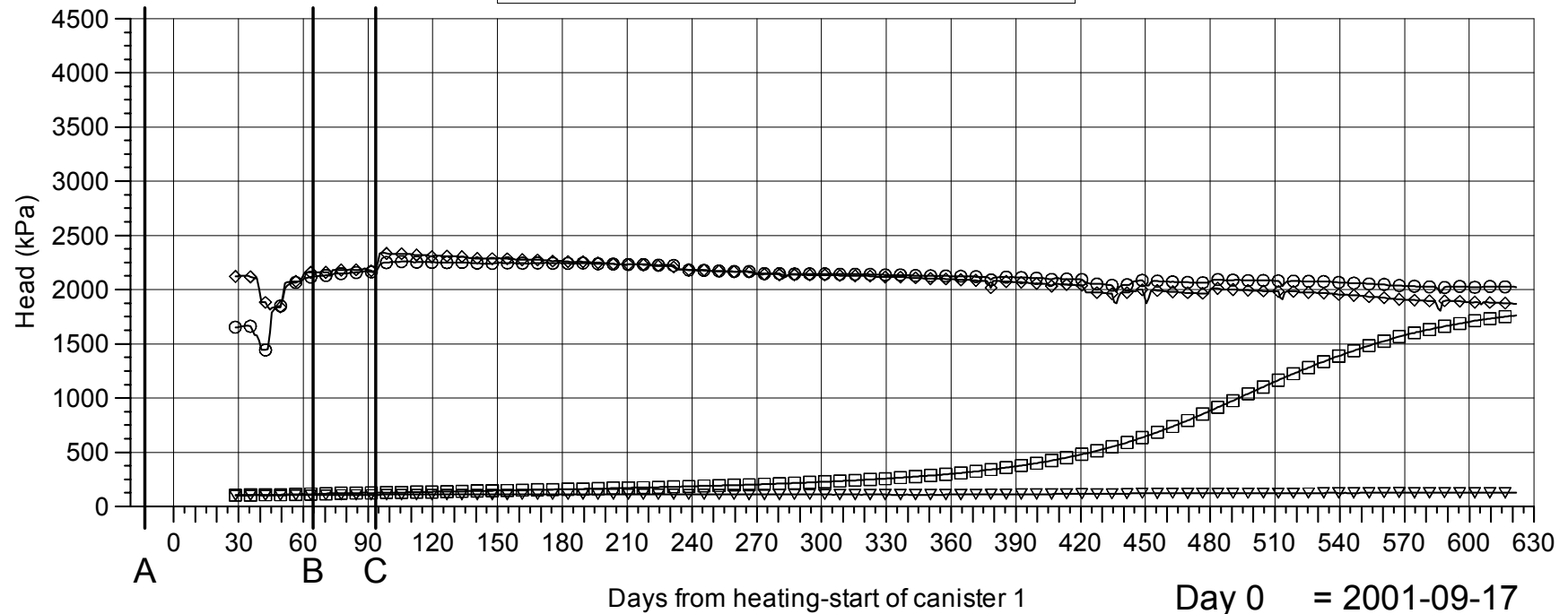

Day 0 = 2001-09-17
 Day 622 = 2003-06-01

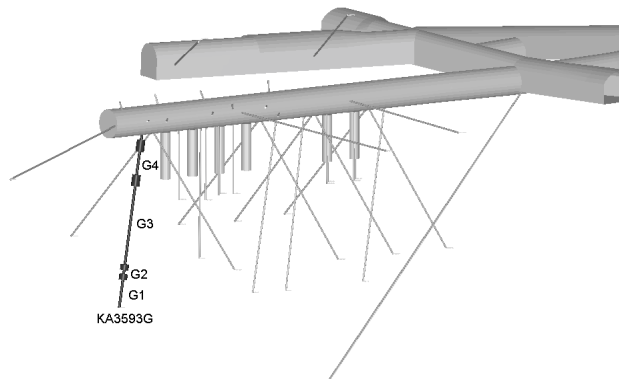

Borehole sections	
—▽—	G:1 25.2 m - 30 m
—◇—	G:2 23.5 m - 24.2 m
—□—	G:3 9 m - 22.5 m
—○—	G:4 3 m - 7 m

KA3592C01, KA3597D01, KA3597H01 PRESSURE HEAD

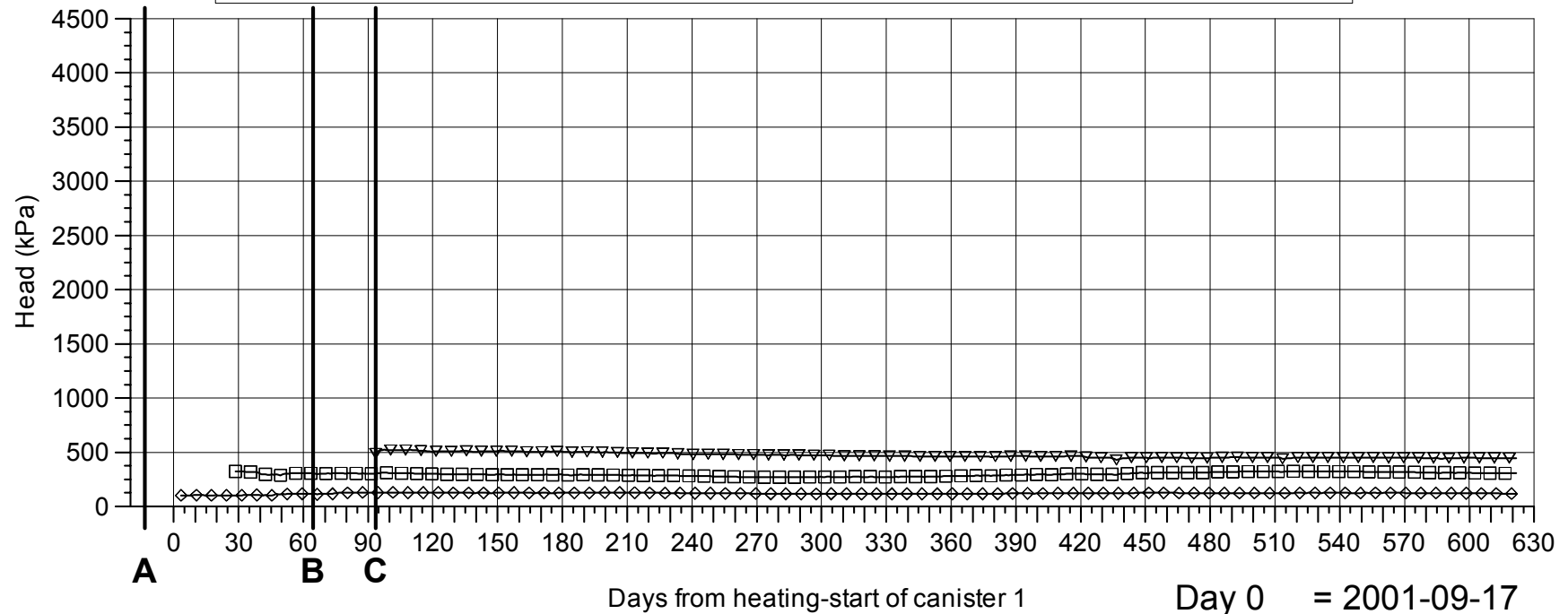

Day 0 = 2001-09-17
Day 622 = 2003-06-01

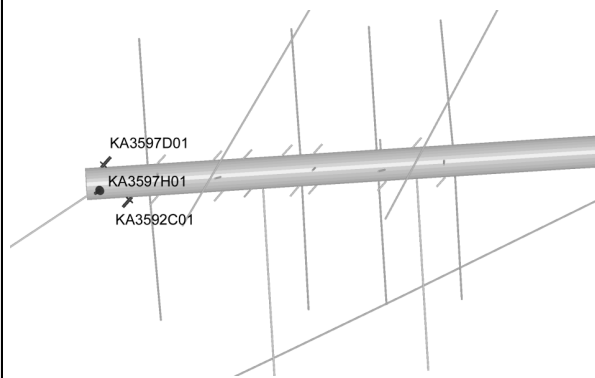

Events

A - Start backfilling 2001-09-03
B - Stop backfilling 2001-11-20
C - Casting inner plug finalized

Borehole sections

—▽— KA3592C01:1 0.65 m - 2 m
—◇— KA3597D01:1 0.65 m - 2 m
—□— KA3597H01:1 0.65 m - 2 m

KA3600F PRESSURE HEAD

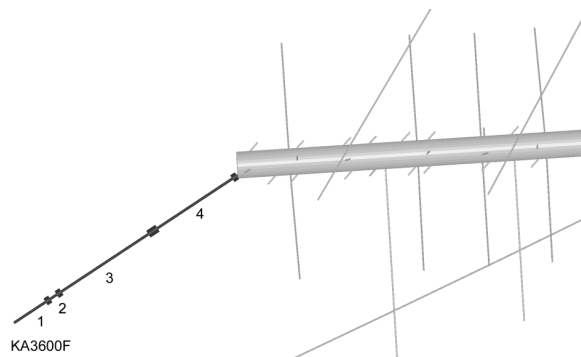
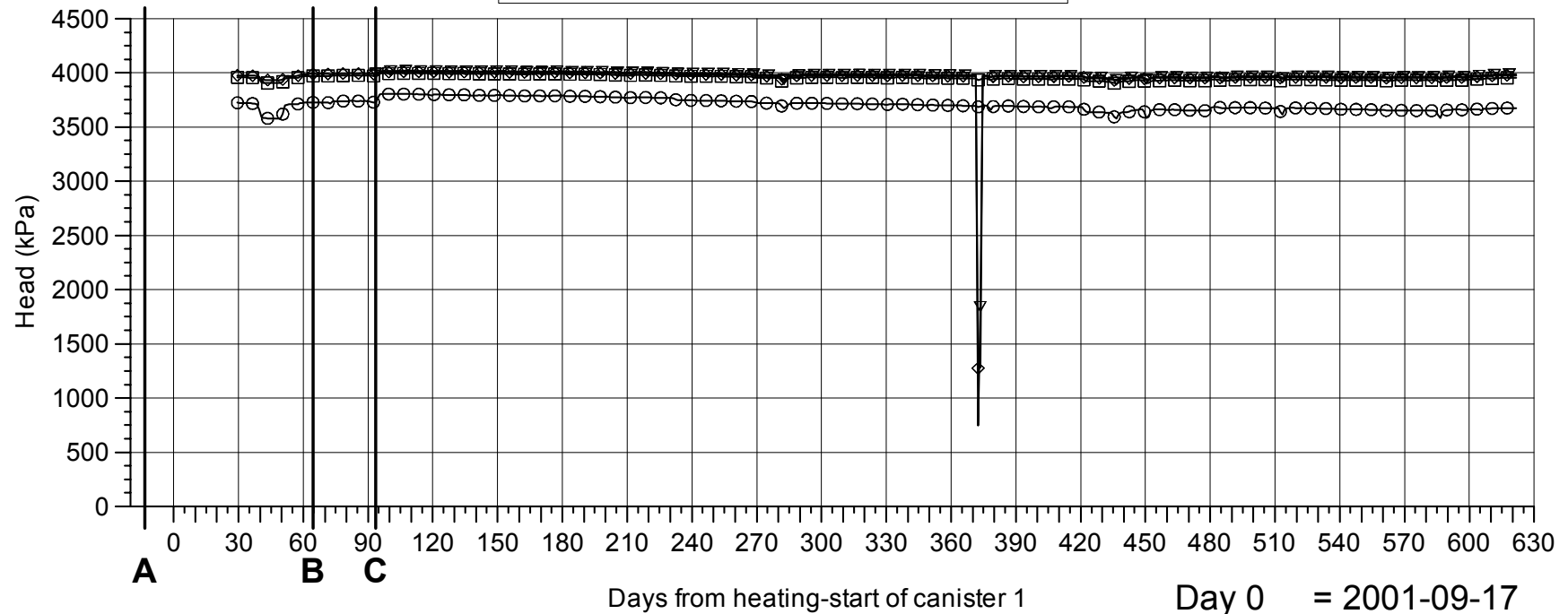

Events

- A - Start backfilling 2001-09-03
- B - Stop backfilling 2001-11-20
- C - Casting inner plug finalized

Borehole sections

- ▽— F:1 43 m - 50.1 m
- ◇— F:2 40.5 m - 42 m
- F:3 20 m - 39.5 m
- F:4 3.4 m - 18 m

P_KA3600F.GRF 2003-06-16

KG0021A01 PRESSURE HEAD

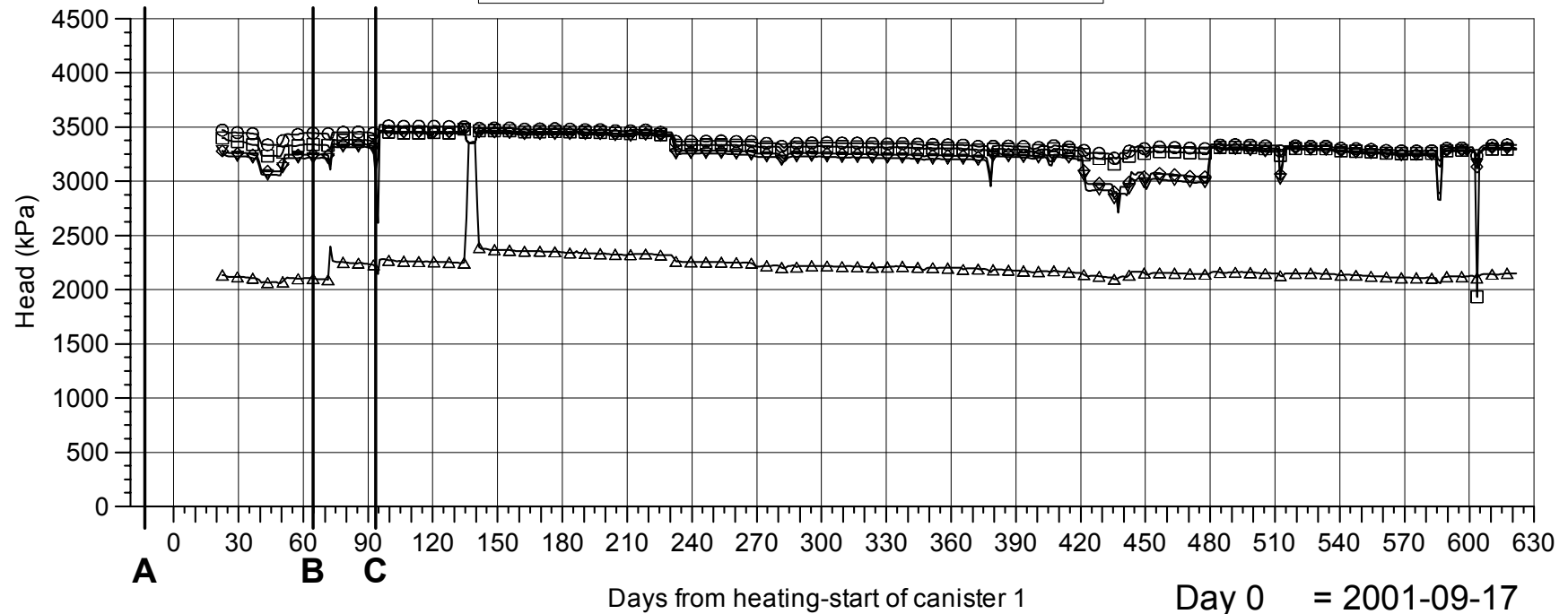

Day 0 = 2001-09-17
Day 622 = 2003-06-01

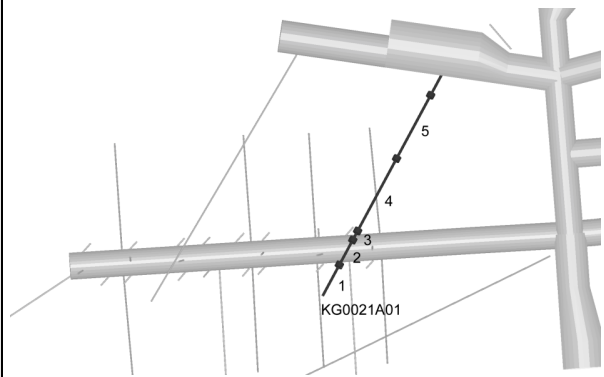

- Events**
- A - Start backfilling 2001-09-03
 - B - Stop backfilling 2001-11-20
 - C - Casting inner plug finalized

- Borehole sections**
- ▽— A01:1 42.5 m - 48.82 m
 - ◇— A01:2 37 m - 41.5 m
 - A01:3 35 m - 36 m
 - A01:4 19 m - 34 m
 - △— A01:5 5 m - 18 m

KG0048A01 PRESSURE HEAD

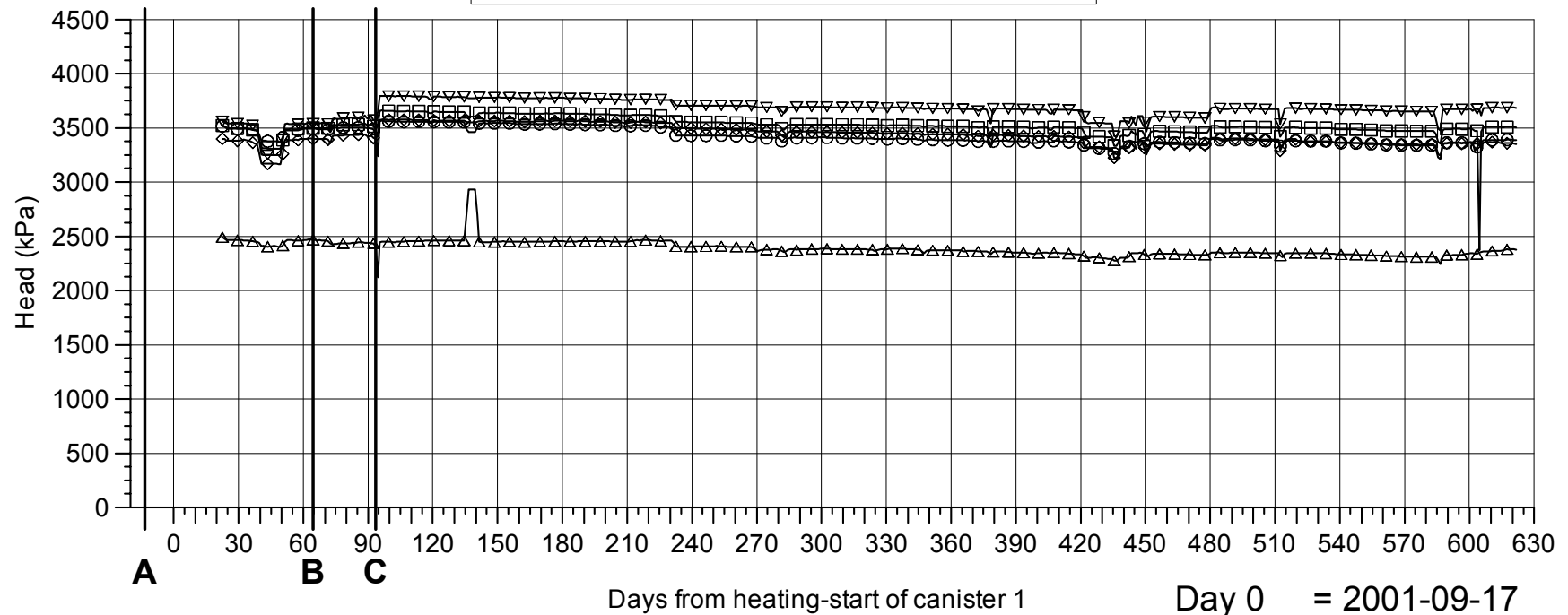

Day 0 = 2001-09-17
Day 622 = 2003-06-01

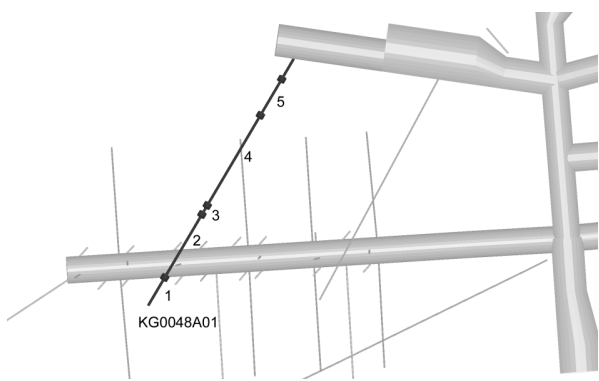

- Events**
- A - Start backfilling 2001-09-03
 - B - Stop backfilling 2001-11-20
 - C - Casting inner plug finalized

- Borehole sections**
- ▽— A01:1 49 m - 54.69 m
 - ◇— A01:2 34.8 m - 48 m
 - A01:3 32.8 m - 33.8 m
 - A01:4 13 m - 31.8 m
 - △— A01:5 5 m - 12 m

MG0004G WEIR FLOW

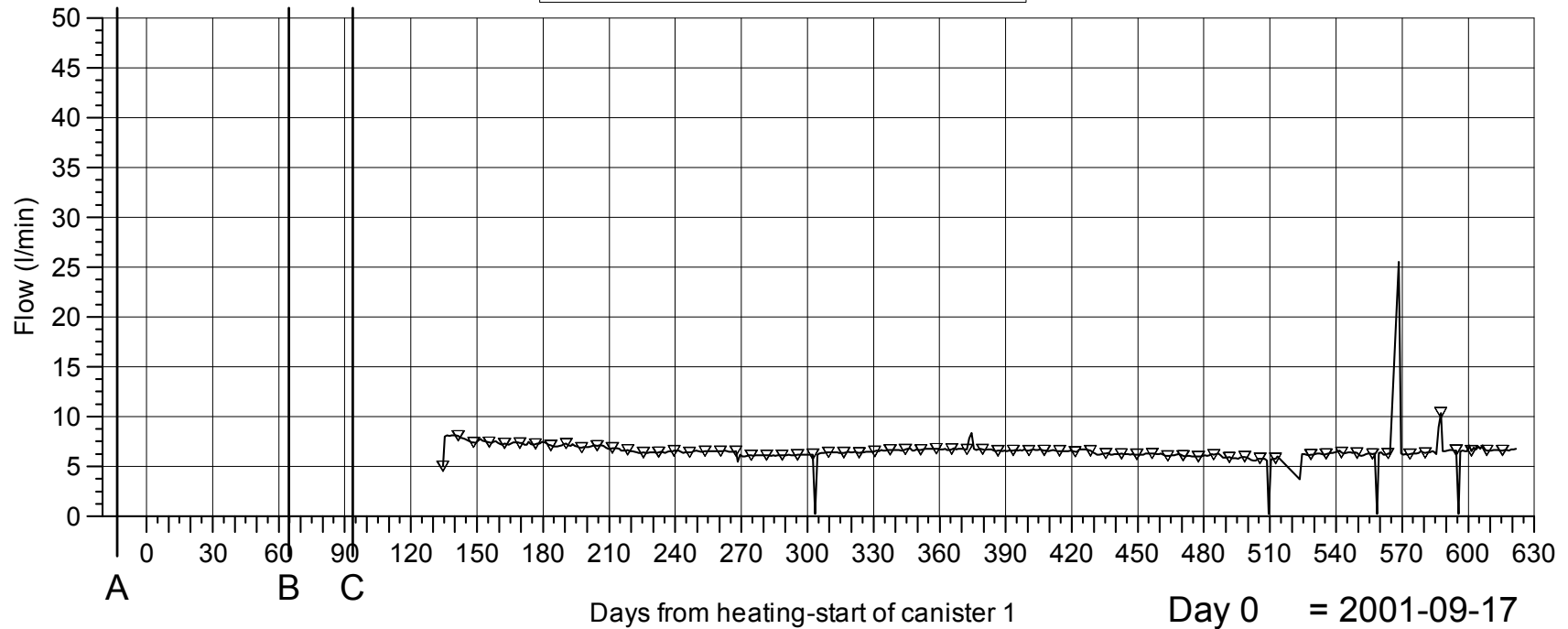

Day 0 = 2001-09-17
 Day 622 = 2003-06-01

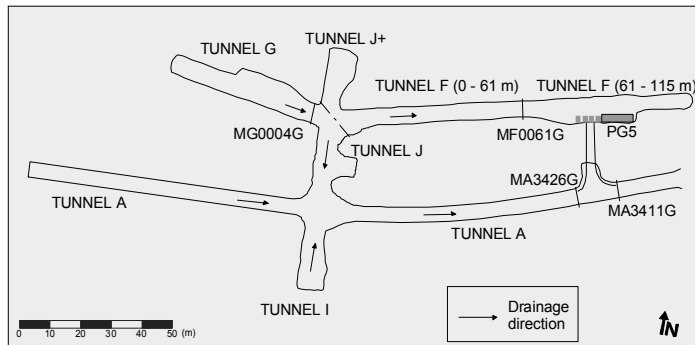

- Events**
- A - Start backfilling 2001-09-03
 - B - Stop backfilling 2001-11-20
 - C - Casting inner plug finalized

—▽— WEIR MG0004G

MF0061G WEIR FLOW

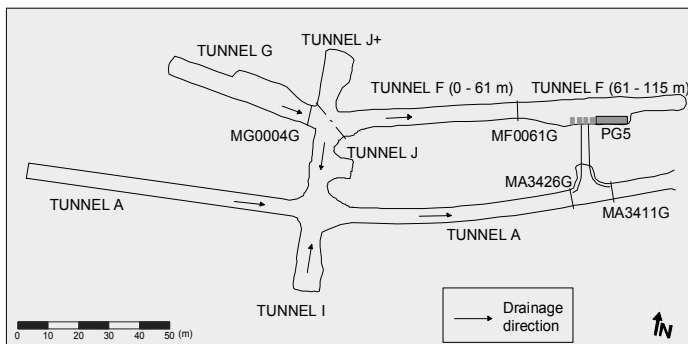
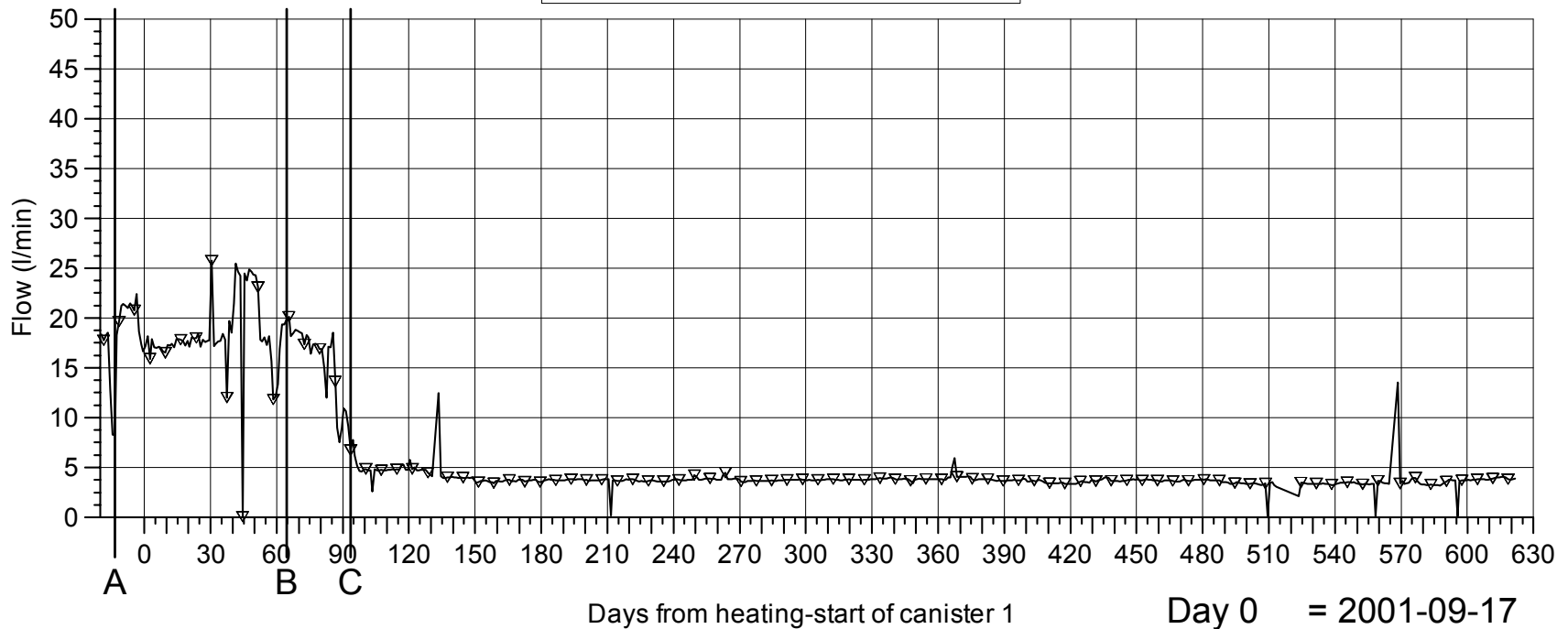

Events

- A - Start backfilling 2001-09-03
- B - Stop backfilling 2001-11-20
- C - Casting inner plug finalized

MA3426G WEIR FLOW

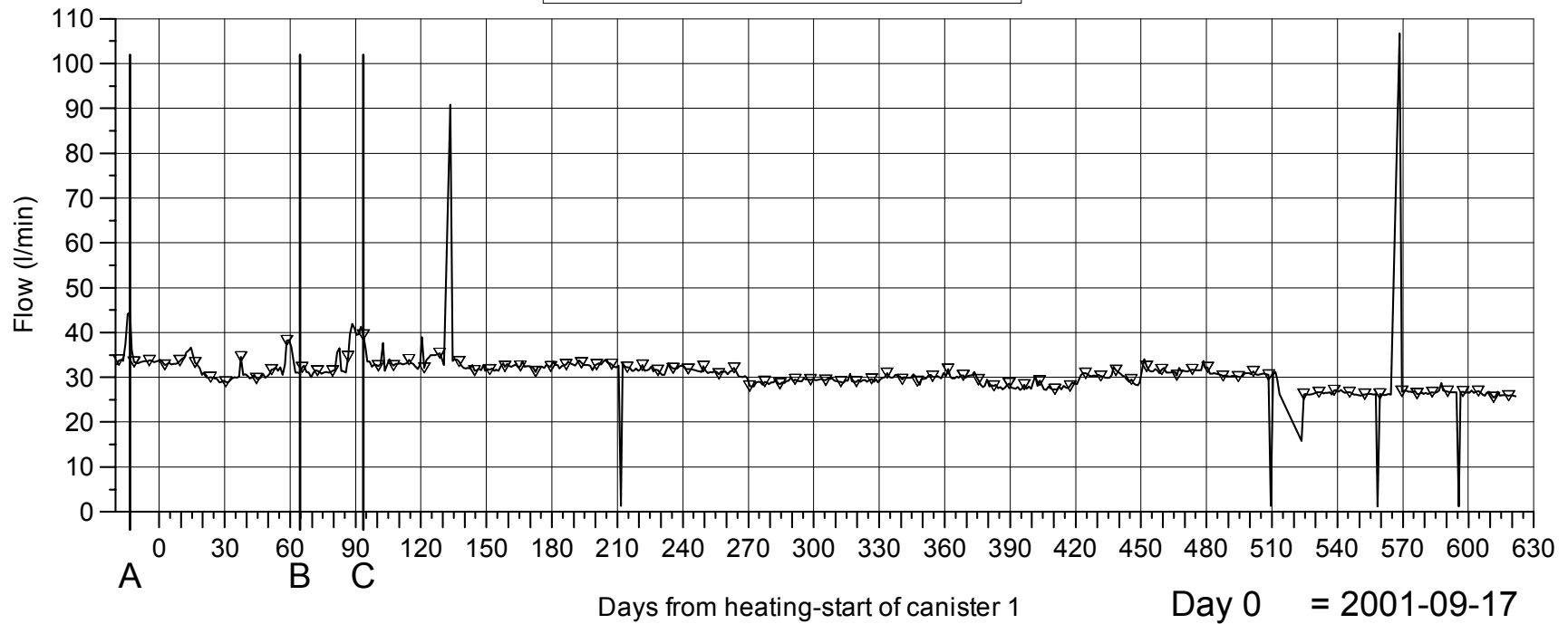

Day 0 = 2001-09-17
 Day 622 = 2003-06-01

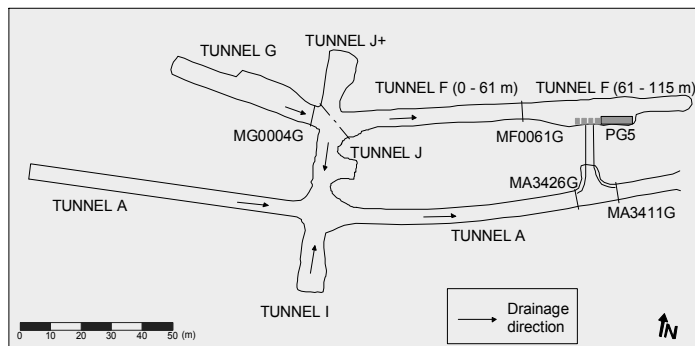

Events

- A - Start backfilling 2001-09-03
- B - Stop backfilling 2001-11-20
- C - Casting inner plug finalized

— ▽ — WEIR MA3426G

Quick guide

Transducers in the backfill

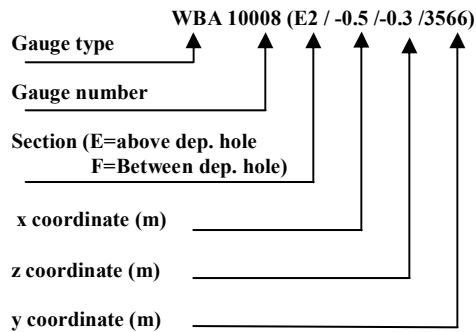

Transducers in dep. holes 1 and 3 and in the rock

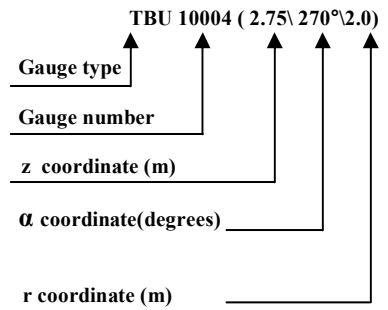

Coordinate system in backfill

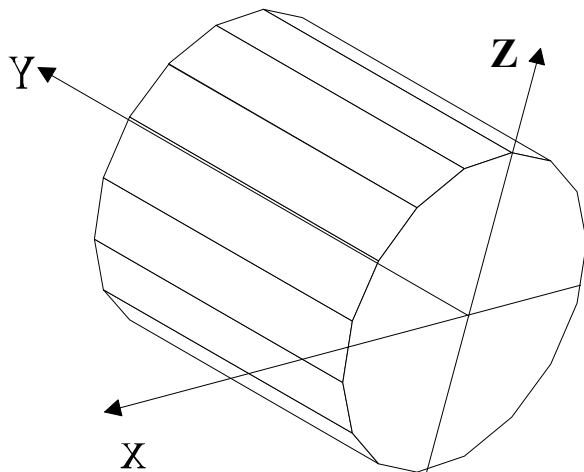

Coordinate system in dep. holes

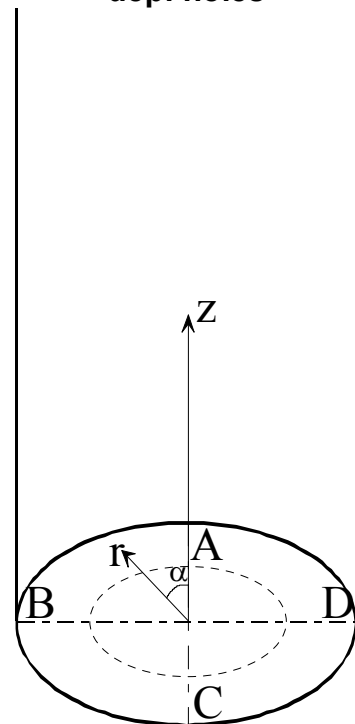

End of tunnel at Y =3599.8 m
 Center dep.hole 1.at Y =3587 m
 Center dep.hole 2 at Y =3581 m
 Center dep.hole 3 at Y =3575 m
 Center dep.hole 4 at Y =3569 m
 Inner plug surface at Y=3561.4 m
 Tunnel radius Z=X =2.5 m

Tunnel direction C-A
 Bottom of hole Z=0
 Bottom of canister Z=0.5
 Top of canister Z=5.400
 Upper buffer surface Z=7.125
 Dep. hole radius r=0.875
 Canister radius r=0.525