

## **Simpevarp site investigation**

### **Geophysical, radar and BIPS logging in borehole KSH01A, HSH01, HSH02 and HSH03**

Per Nilsson, Christer Gustafsson  
RAYCON

April 2003

**Svensk Kärnbränslehantering AB**

Swedish Nuclear Fuel  
and Waste Management Co  
Box 5864  
SE-102 40 Stockholm Sweden  
Tel 08-459 84 00  
+46 8 459 84 00  
Fax 08-661 57 19  
+46 8 661 57 19



## **Simpevarp site investigation**

# **Geophysical, radar and BIPS logging in borehole KSH01A, HSH01, HSH02 and HSH03**

Per Nilsson, Christer Gustafsson  
RAYCON

April 2003

*Keywords:* BIPS, RAMAC, Wellmac, radar, TV, geophysical logging.

This report concerns a study which was conducted for SKB. The conclusions and viewpoints presented in the report are those of the authors and do not necessarily coincide with those of the client.

A pdf version of this document can be downloaded from [www.skb.se](http://www.skb.se)

# Contents

<b>1</b>	<b>Introduction</b>	<b>5</b>
<b>2</b>	<b>Objective and scope</b>	<b>7</b>
<b>3</b>	<b>Equipment</b>	<b>9</b>
3.1	Wellmac	9
3.1.1	Description of the Wellmac system	9
3.1.2	Temperature and fluid resistivity	10
3.1.3	Caliper measurements	11
3.1.4	Electrical methods	11
3.1.5	Magnetic methods (Susceptibility)	13
3.1.6	Natural gamma	13
3.1.7	Density	13
3.2	Radar measurements RAMAC	14
3.3	TV-Camera, BIPS	15
<b>4</b>	<b>Execution</b>	<b>17</b>
4.1	Execution of measurements	17
4.1.1	Wellmac logging	17
4.1.2	RAMAC Radar	18
4.1.3	BIPS	21
4.2	Analyses and Interpretation	22
4.2.1	Wellmac logging	22
4.2.2	RAMAC Radar	22
4.2.3	BIPS	24
<b>5</b>	<b>Results and data delivery</b>	<b>25</b>
5.1	Wellmac logging	25
5.2	RAMAC Radar	25
5.3	BIPS	28
<b>Appendices</b>		
1	Geophysical logging, Wellmac in boreholes KSH01A (0–100 m), HSH01, HSH02and HSH03	29
2	Radar logging dipole antennas 100 and 250 MHz in boreholes KSH01A (0–100 m), HSH01, HSH02and HSH03	43
3A	BIPS results from the upper part of KSH01A	57
3B	BIPS results from HSH01	81
3C	BIPS results from HSH02	129
3D	BIPS results from HSH03	173

# 1 Introduction

This document reports the data gained during logging operations, which is one of the activities performed within the site investigation at Simpevarp in Oskarshamn. The logging operations presented here include geophysical logging with Wellmac, RAMAC and BIPS. In total, 700 metres of logging was carried out in four percussion-drilled boreholes. The boreholes in question are; upper 100m of KSH01A (100 m/diameter 165 mm), HSH01 (200 m/diameter 140 mm), HSH02 (200 m/diameter 140 mm) and HSH03 (200 m/diameter 140 mm). The borehole referred to as KSH01A is the uppermost, percussion drilled part of a c 1000 m deep core drilled hole.

All measurements were conducted by RAYCON during September 2002 in accordance with the instructions and guidelines from SKB (activity plan AP PS 400-02-010 and method description MD 221.002, SKB internal controlling documents) and under supervision of Leif Stenberg, SKB. The location of the boreholes is shown in Figure 1-1.

Instruments used:

- Borehole radar (RAMAC) system with dipole radar antennas.
- Borehole TV system (BIPS), a high resolution, side viewing, colour borehole TV system.
- Borehole geophysical logging system (WELLMAC).



Borrhål:	X-koordinat:	Y-koordinat:	
KSH01	1552442,971	6366013,519	Pågår
KSH02	1551525	6365660	Planerat
KSH03	1550906	6365297	Planerat
HSH01	1552545,717	6366217,770	Klart
HSH02	1551368,337	6365682,896	Klart
HSH03	1552544,526	6366213,946	Klart

*Figure 1-1. General overview over the Simpevarp subarea.*



## **2 Objective and scope**

The objective of the surveys is to both receive information of the borehole itself, and from the rock mass around the borehole. Bore hole radar was used to investigate the nature and the structure of the rock mass located around the boreholes, and BIPS for geological surveying and fracture mapping and orientation. Geophysical logging was used to measure changes in physical properties in the borehole fluid and the bedrock surrounding the boreholes.

This field report describes the equipment used as well the measurement procedures. For the BIPS survey, the result is presented as images. Radar data is presented in radargrams and identified reflectors in each borehole are listed in tables. Geophysical logging data is presented in graphs as a function of depth.

## 3 Equipment

### 3.1 Wellmac

The objective of the geophysical logging has been to determine various physical parameters in the borehole vicinity that describes the surrounding rock. The following logging methods have been used:

- Fluid resistivity
- Temperature
- Caliper
- Normal Resistivity 0.4 m
- Lateral
- Single point resistance
- Magnetic susceptibility
- Natural gamma ray
- Density

#### 3.1.1 Description of the Wellmac system

Malå Geoscience, Sweden produces the WELLMAC Logging System, used within this study, Figure 3-1. The geophysical logging system includes five major parts, a measuring probe suite, a power supply/modem probe, a surface unit with software, a cable drum or winch and a depth-measuring wheel.

Each probe can be used individually or assembled with up to six others to form a probe suite. The power supply/modem probe (controller probe) is always mounted at the top of the probe suite. Its task is to take care of power supply to the probes and data communication between the surface unit and the probes.

#### **Surface equipment**

The surface unit used for probe control and data acquisition is based on an IBM-AT compatible computer. It is watertight and designed for use in harsh environments. Log data from the probes are continuously displayed on the screen while measuring proceeds. Data is stored on a hard drive and/or floppy disks. Moreover, data can be printed out in real time on a printer connected to the surface unit. During this project a laptop computer was used instead of the above surface unit.

The surface equipment consists of the following parts:

- Computer
- Measuring wheel with digital counter
- Winch with cable
- Power supply (generator) or 220 V

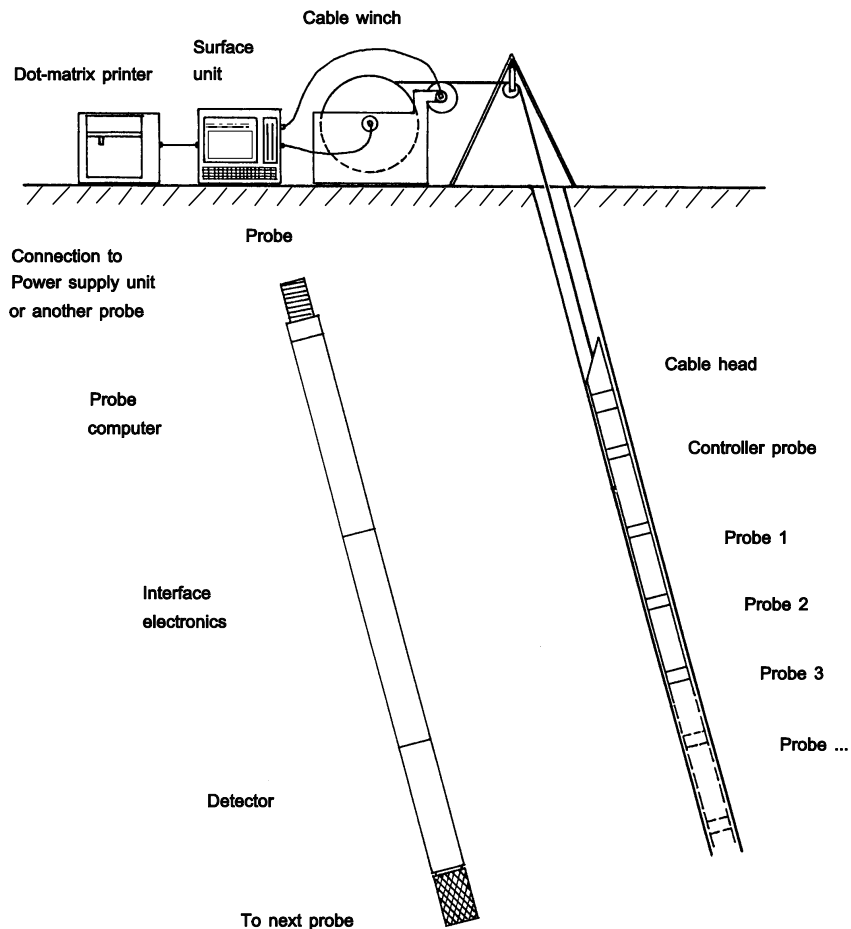

*Figure 3-1. The Wellmac system.*

The motor-driven winch used in this study is electrically powered by portable generators or when available by 220 AC power.

The depth-measuring wheel, which also serves as a pulley, has a 1-metre circumference and is mounted on a tripod. The depth-measuring device is an odometer that sends data to the surface unit.

### **3.1.2 Temperature and fluid resistivity**

The temperature and resistivity of the borehole fluid are measured simultaneously using the same probe. The best accuracy and resolution are when measuring discrete points, but it is also possible to measure continuously. In this investigation, both the temperature and the fluid resistivity were measured continuously.

## ***Temperature***

The temperature is measured with a thermistor. When measuring discrete points the absolute accuracy is 0.06°C and the relative accuracy 0.004°C. When measuring continuously these values are 0.1°C and 0.05°C respectively. Calibration is done in the laboratory using a quartz thermometer. The results are expressed in °C.

## ***Fluid resistivity***

The resistivity of the borehole fluid is measured by a five-electrode system. The electrodes are positioned in a plastic tube open at both ends. The insulation from the formation is necessary to eliminate the effect of conducting minerals and fractures present in the formation.

Calibration is done in the laboratory where the probe is lowered into water with known salinity. The procedure is repeated for different water salinities.

The results are expressed in ohmmetres and can, after correction for the temperature, be used to calculate the salinity of the drillhole fluid. The results can also be used for corrections of the data obtained from the electric measurements.

### **3.1.3 Caliper measurements**

The borehole diameter is measured continuously along the borehole by means of a three-arm caliper connected to the main surface unit. The caliper measures the diameter using three motor-actuated spring loaded arms. The caliper can be closed and opened by remote control and includes different sets of caliper arms to obtain highest possible accuracy depending on the actual borehole diameter.

Calibration of the caliper tool is done manually by placing the probe into jigs of known diameters. At the site calibration was also performed running the tool in the casing.

### **3.1.4 Electrical methods**

All electrical methods are based on the ability of minerals and rock to conduct electricity. Electrical methods cannot be run in empty boreholes, boreholes with non-conductive mud or boreholes with casing, since the electrodes of the probes need to be in electrical contact with the surrounding rock formations.

Electrical methods are used to measure electrical resistance in the bedrock surrounding the borehole, and the natural potential in the rock. These methods introduced by Schlumberger in 1928 were the first geophysical techniques used in well logging.

The resistivity probe used in this project is able to measure five electrical parameters at the same time. These are; short normal, long normal and lateral resistivity, single point resistance and spontaneous potential. The major difference between the various electrical methods, except spontaneous potential and single point resistance, is the electrode configuration.

## **SP**

Self-potential or spontaneous potential (SP) is usually taken as the measured voltage of a downhole electrode relative to a surface electrode.

Self-potential variations in a borehole may arise from the diffusion of ions either from the borehole fluid into the formation or the reverse, and from oxidation-reduction reactions of minerals in the vicinity of the borehole.

### ***Single point resistance (SPR)***

The single point resistance method consists of a two-electrode system with one of the electrodes in the borehole and one at the surface. The small electrode (length 2 cm) in the borehole is surrounded by an insulator slightly less than the diameter of the borehole to reduce the effect of electrically conductive groundwater in the borehole. The resistance may be measured at any of four different frequencies; 3, 11, 33 or 110 Hz. The frequency used in this investigation was 11 Hz.

The results are calibrated, and if necessary also corrected for borehole size, and expressed in ohm.

### ***Normal resistivity***

The resistivity of the bedrock is determined by means of a four electrode system. In the normal configuration one current and one potential electrode are located in the borehole. The distance between the active electrodes in the borehole is 1.6 m respectively 0.4 m. The other two electrodes are placed at the surface approximately 50 m from the borehole in opposite directions. Two different normal configurations were used in this investigation. Data presented and delivered are from the 0.4 m configurations.

Calibration of the resistivity system is done at the site by connecting a variable resistor to the system, thus calibrating the response to a known resistance. The results are expressed in ohmmetres.

### ***Lateral resistivity***

The lateral configuration has one current electrode and two potential electrodes in the borehole, while the other current electrode is on the surface. The distance between the current electrode and the first potential electrode is 1.6 metre and the distance between the potential electrodes is 0.1 metre. This configuration has a radius of investigation that is approximately equal to the distance between the middle point of the two potential electrodes and the current electrode. The major advantage of the lateral configuration compared to the normal configuration is its ability to detect thin layers. However, the true resistivity of a layer will be read only if it is much thicker than the radius of investigation.

### **3.1.5 Magnetic methods (Susceptibility)**

This probe is used to determine the magnetic susceptibility of the bedrock. Magnetic susceptibility is defined as the ratio of the intensity of magnetization of a magnetizable substance to the intensity of an applied magnetic field. The magnetic susceptibility of a rock depends on the concentration of ferromagnetic minerals in the rock, such as magnetite, titanomagnetite, ilmenite and pyrrhotite. Changes in the concentrations of ferromagnetic minerals usually coincide with lithological changes in the rock. The susceptibility probe can also be used for the location of fracture zones, due to oxidation of magnetite to hematite in the fracture zones.

The magnetic susceptibility sensor consists of a solenoid, wound on a high permeability core and connected to an electrical bridge. The presence of ferromagnetic minerals in the rock causes a change in the magnetic field that changes the amount of electric current in the coil. These changes are measured with the electrical bridge circuit, and translated into calibrated magnetic susceptibility units.

The instrument has three measuring ranges, viz.  $0-2 \times 10^{-2}$ ,  $0-2 \times 10^{-1}$  and  $0-2$  SI units, and the resolution is  $5 \times 10^{-5}$  SI units. Calibration is done in calibration pads with known magnetic susceptibility.

### **3.1.6 Natural gamma**

This probe measures the natural gamma radiation in the borehole. Gamma radiation in the borehole is due to decomposition of radioactive isotopes. The most significant contribution to the radiation is given by isotopes of  $^{40}\text{K}$ , U and Th. Changes in the concentrations of these elements usually coincide with lithological changes in the rock. Generally, acid rocks correspond to high values of radiation and mafic rocks to low values. Gamma radiation is also a good method for locating alteration zones.

The probe contains a scintillation detector. The active part is a 1.5 inch crystal of NaI, which is connected to a photomultiplier tube that transforms the light pulses created in the crystal to electrical signals proportional to the incoming gamma rays. The lower cut-off limit in gamma ray energy is 300 KeV.

For calibration a well-known radioactive source is used. After calibration, the results are presented in micro Roentgen/hour.

### **3.1.7 Density**

The density or gamma-gamma probe measures rock density and is used mainly for lithology determinations. Further, if the matrix density is known, rock porosity variations can be determined. This in turns leads to the possibility of locating fracture zones.

The density probe is in principle a gamma probe with a shielded radioactive source. The radioactive source used in this case is 300 mCi Cesium-137, which emits gamma rays at 662 keV. The emitted gamma rays enter the formation where they gradually lose energy through interaction with nuclei in the rock, until they are either entirely absorbed by the

rock matrix or reach the detector. Formations with high density absorb more gamma rays than formations with low density.

There are three kinds of interaction between gamma rays and matter that can affect the detector response: Compton scattering, photoelectric absorption and pair production. However, the probability of a specific gamma ray interaction occurring will depend on the energy of the gamma ray. The photoelectric effect is the dominating process for gamma ray energies below 100 keV, while pair production occurs if the gamma ray energy is above the threshold value of 1022 keV. At the energy level of the radioactive source used in the density probe, the dominating process is Compton scattering

Calibration of the density probe is done on a regular basis at a site in Malå. The calibration site consists of a number of boreholes with different diametres and formation density.

### 3.2 Radar measurements RAMAC

The RAMAC GPR system owned by SKB is a fully digital GPR system where emphasis has been laid on fast survey speed and easy field operation. The system operates dipole and directional antennas (see Figure 3-2). A system description is given in the SKB Report MD 252.21.

The borehole-radar system consists of a transmitter and a receiver. During operation an electromagnetic pulse, within the frequency range of 20 Mhz and 250 Mhz, is emitted into the bedrock. Once a feature, e.g. a water-filled fracture, with different electrical properties is encountered, the pulse is reflected back to the receiver.

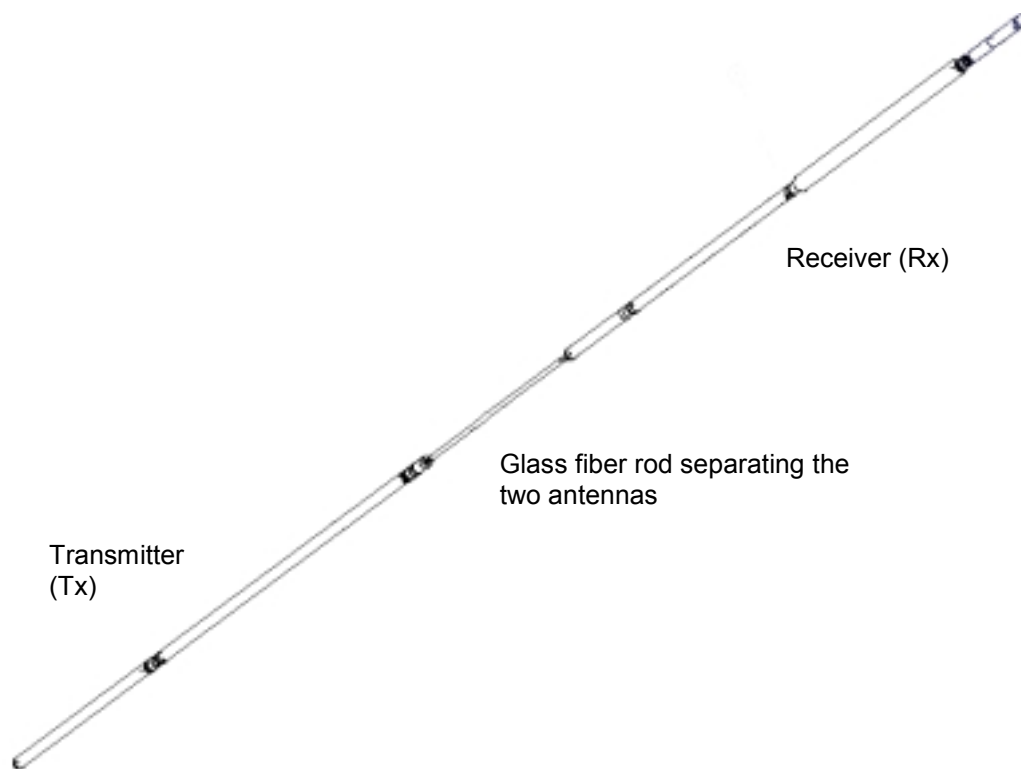
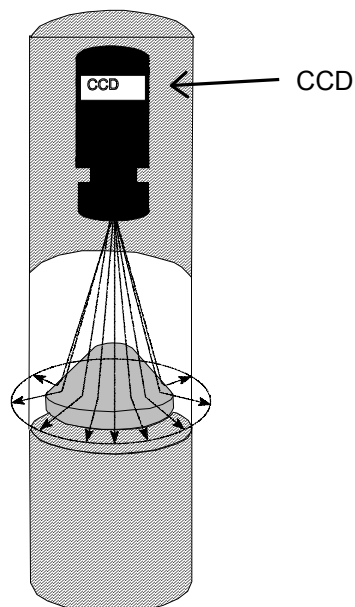

*Figure 3-2. Example of borehole radar antennas.*

### 3.3 TV-Camera, BIPS

The BIPS 1500 system used is owned by SKB and described in SKB Report MD 222.005. The BIPS method for borehole logging produces a digital scan of the borehole wall. In principle, a standard CCD video camera is mounted in a probe in front of a conical mirror (see Figure 3-3). An acrylic window covers the mirror part and the borehole image is reflected in through the window and displayed on the cone, from where it is recorded. During the measuring operation, pixel circles are scanned with a resolution of 360 pixels/circle. The digitalized circle is then stored for every 1 millimetre on MO-disk in the surface unit.

There is two ways to orientate the images, compass or gravity. The compass is used for vertical boreholes and the gravity sensor for inclined boreholes. In this case we have used the gravity sensor for the orientation.



*Figure 3-3. The conical mirror scanning for the BIPS system.*



## 4 Execution

All boreholes were logged to full length, except for KSH01A that was only investigated down to 100 m, i.e. the percussion drilled part.

### 4.1 Execution of measurements

#### 4.1.1 Wellmac logging

To allow perfect depth control of the individual runs the Gamma probe was attached to the tool string for all individual runs. In KSH01A, HSH01, HSH02 and HSH03, five rounds of measurements were performed in every borehole. First, the Gamma and Temp/Fluid resistivity probes were used and afterwards the remaining probes were employed.

For the geophysical logging, the following combinations were used:

1. Gamma/Temp/Fluid resistivity
2. Gamma/Caliper
3. Gamma/Susceptibility
4. Gamma/Lateral/Normal/SPR
5. Gamma/Density

Measurements were taken during continuous movement of the probes at a depth interval of 0.1 metres. Data from the measurements were recorded on a field PC.

For further information see the SKB Report MD 221.002 for method description and MD 600.004 for cleaning of equipment.

To obtain good quality of the density recordings, calibration measurements performed in Forsmark was used. Two boreholes with a diameter of 140 mm were drilled in boulders and the boulders were sampled for density determination in the laboratory. Analyses of the samples are presented in Table 4-1. The final results is presented in the standard density unit, kg/m<sup>3</sup>.

**Table 4-1. Results from parameter measurements of samples from surface blocks.**

<b>SAMPLE</b>	<b>kg/m<sup>3</sup></b>
SKBA1	2993
SKBA2	2997
SKBA3	2990
SKBB1	2646
SKBB2	2637
SKBB3	2645
SKBB4	2629

All final data is delivered on ASCII format with depth and value of every single method.

#### 4.1.2 RAMAC Radar

For borehole radar measurements in KSH01A, HSH01, HSH02 and HSH03 dipole antennas were used, Figure 4-1. The dipole antennas used have a central frequency of 100 MHz and 250 MHz.

During logging the dipole antennas (transmitter and receiver) were lowered continuously in the borehole and the data recorded on the field PC along the measured interval. The antennas (transmitter and receiver) are kept at a fixed separation by glass fiber rods according to Table 4-2. See also Figure 3-2.

For further information see the SKB Report MD 252.020 for method description and MD 600.004 for cleaning of equipment.

For information on system settings for the different antennas used in the investigation of KSH01A, HSH01, HSH02 and HSH03 see Table 4-2 – Table 4-5 below.

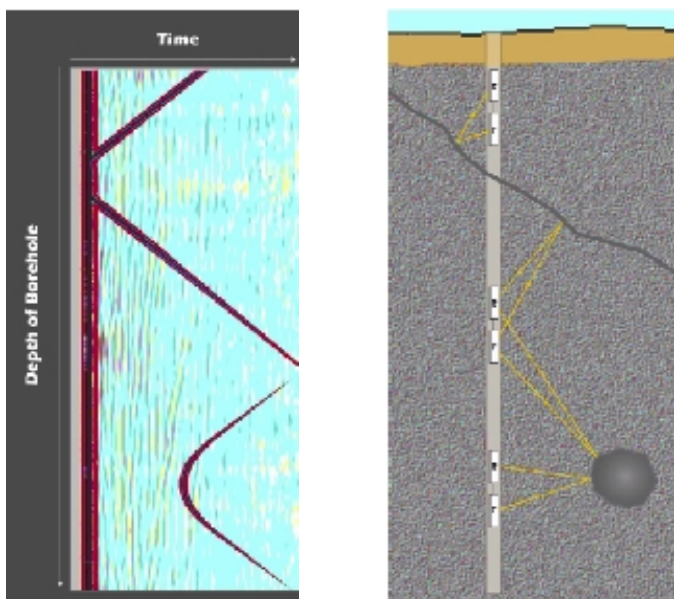

*Figure 4-1. The principle of radar borehole reflection survey and an example of result*

**Table 4-2. Radar logging information from KSH01A.**

<b>SITE: SIMPEVARP</b> <b>BH: KSH01A</b> <b>TYPE: Dipole</b> <b>Operators: PN/CG</b>	<b>Logging company: RAYCON</b> <b>Equipment: SKB RAMAC</b> <b>Manufacturer: MALÅ GeoScience</b>			
	<b>Antenna</b>			
			<b>100 MHz</b>	
Logging date:			2002-09-15	
Reference:			Top of casing	
Sampling frequency (MHz):			913	
Number of samples:			518	
Number of stacks:			32	
Signal position:			-0.300	
Logging from (m):			2.1	
Logging to (m):			97.8	
Trace interval (m):			0.1	
Antenna separation (m):			2.9	

**Table 4-3. Radar logging information from HSH01.**

<b>SITE: SIMPEVARP</b> <b>BH: HSH01</b> <b>TYPE: Dipole</b> <b>Operators: PN/CG</b>	<b>Logging company: RAYCON</b> <b>Equipment: SKB RAMAC</b> <b>Manufacturer: MALÅ GeoScience</b>			
	<b>Antenna</b>			
		<b>250 MHz</b>	<b>100 MHz</b>	
Logging date:		2002-09-19	2002-09-19	
Reference:		Top of casing	Top of casing	
Sampling frequency (MHz):		2588	914	
Number of samples:		673	518	
Number of stacks:		32	32	
Signal position:		-0.354	-0.367	
Logging from (m):		1.3	2.1	
Logging to (m):		195.3	195.1	
Trace interval (m):		0.1	0.1	
Antenna separation (m):		1.9	2.9	

**Table 4-4. Radar logging information from HSH02.**

<b>SITE: SIMPEVARP</b> <b>BH: HSH02</b> <b>TYPE: Dipole</b> <b>Operators: PN/CG</b>	<b>Logging company: RAYCON</b> <b>Equipment: SKB RAMAC</b> <b>Manufacturer: MALÅ GeoScience</b>			
	<b>Antenna</b>			
		<b>250 MHz</b>	<b>100 MHz</b>	
Logging date:		2002-09-17	2002-09-17	
Reference:		Top of casing	Top of casing	
Sampling frequency (MHz):		2588	914	
Number of samples:		732	518	
Number of stacks:		32	32	
Signal position:		-0.353	-0.376	
Logging from (m):		3.3	4.1	
Logging to (m):		196.6	194.1	
Trace interval (m):		0.1	0.1	
Antenna separation (m):		1.9	2.9	

**Table 4-5. Radar logging information from HSH03.**

<b>SITE: SIMPEVARP</b> <b>BH: HSH03</b> <b>TYPE: Dipole</b> <b>Operators: PN/CG</b>	<b>Logging company: RAYCON</b> <b>Equipment: SKB RAMAC</b> <b>Manufacturer: MALÅ GeoScience</b>			
	<b>Antenna</b>			
		<b>250 MHz</b>	<b>100 MHz</b>	
Logging date:		2002-09-18	2002-09-18	
Reference:		Top of casing	Top of casing	
Sampling frequency (MHz):		2588	914	
Number of samples:		673	518	
Number of stacks:		32	32	
Signal position:		-0.354	-0.367	
Logging from (m):		1.3	2.1	
Logging to (m):		196.5	195.5	
Trace interval (m):		0.1	0.1	
Antenna separation (m):		1.9	2.9	

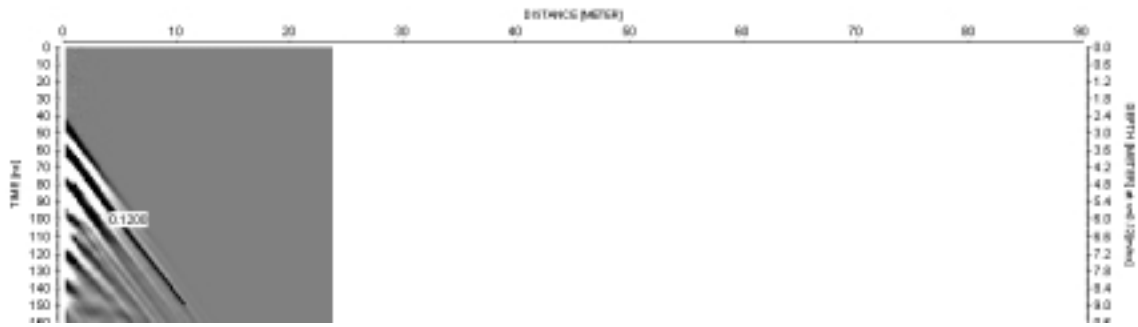

**Figure 4-2.** Results from velocity measurements in HSH01.

There are several ways to determine the radar wave propagation velocity. Each of them has its advantages and its disadvantages. In this project the velocity determination was performed by keeping the transmitter fixed in the borehole while moving the receiver downwards in the borehole. The result is plotted in Figure 4-2 and the calculation shows a velocity of 120 m/micro seconds. The velocity measurement was performed in borehole HSH01 with the 100 MHz antenna.

#### **4.1.3 BIPS**

For information on BIPS measurements, see the SKB Report MD 222.006 for a method description and MD 600.004 for cleaning of equipment.

The measurements were performed according to the method description for the method. A pixel circle with a resolution of 360 pixels/circle was used and the digitalized circles were then stored for every 1 millimetre on a MO-disc in the surface unit, giving a maximum logging speed of 1.5 metres/minute.

There is two ways to orientate the BIPS images, with compass or gravity measurements. The compass is used for vertical boreholes and the gravity sensor for inclined boreholes. In KSH01A, HSH01, HSH02 and HSH03 the gravity sensor was used to measure the orientation.

In percussion-drilled boreholes there is no traces on the borehole walls for calibration of the length measuring devices. Therefore, no depth adjustment is performed on the delivered data. To control the quality of the system, a calibration measurement was performed in a test pipe before start of the logging of the first borehole and after the finish of the last logging. The results showed no difference in colors and focus of the images. Results of the test loggings were included in the delivery of the data in bip-format and pdf-format.

## **4.2 Analyses and Interpretation**

### **4.2.1 Wellmac logging**

The individual runs are adjusted for recording errors of the depth based on the gamma measurements. No correlation from other information related to the drilling or other positioning has been adapted to the results.

The data processing includes calibration versus calibration tables and adjustment for drift if necessary (e.g. temperature drift in the electronics). Statistical noise filtering is not carried out on the data delivered to SKB. On the printouts in this report an average filter over 3 measurements points are applied on the gamma and density readings.

The visualization of data in Appendix 1 is made with WellCad, a Windows based processing software for filtering, presentation and analysis of geophysical logging data.

### **4.2.2 RAMAC Radar**

The result from radar measurements is most often presented in the form of radargrams where the position of the probes is shown along one axis and the propagation is shown along the other axis. The amplitude of the received signal is shown in the radargrams with a gray scale where black color corresponds to the large positive signals and white color to large negative signals. Grey color corresponds to no reflected signals.

The presented data in this report is related to for the measurement point of the antennas. The measurement point is defined to be the central point between the transmitter and the receiver antenna.

The two basic patterns to interpret in borehole measurements are point and plane reflectors, see Figure 4-1. In the reflection mode, borehole radar essentially gives a high-resolution image of the rock mass, showing the geometry of plane structures which may or may not, intersect the borehole (contact between layers, thin marker beds, fractures) or showing the presence of local features around the borehole (cavities, lenses etc).

The distance to a reflecting object or plane is determined by measuring the difference in arrival time between the direct and the reflected pulse. The basic assumption is that the speed of propagation is the same everywhere. A rock velocity of 120 m/ $\mu$ s is adopted for all the interpretations made, as calculated from measurements in borehole HSH01.

The visualization of data in Appendix 1 is made with REFLEX, a Windows based processing software for filtering and analysis of radar data. The processing steps are shown in Table 4-6 – Table 4-9.

For the interpretation of the intersection angle between the borehole axis and the planes visible on the radargrams the Radinter SKB software has been used. The interpreted intersection point and intersection angle of the detected structures are presented in Tables 5-2 – 5-5. The detected structures are also visible on the radargrams in Appendix 2.

**Table 4-6. Processing steps for borehole radar data from KSH01A.**

<b>SITE: SIMPEVARP</b> <b>BH: KSH01A</b> <b>TYPE: Dipole</b> <b>Interpret: PN</b>	<b>Logging company: RAYCON</b> <b>Equipment: SKB RAMAC</b> <b>Manufacturer: MALÅ GeoScience</b>			
	<b>Antenna</b>			
			<b>100 MHz</b>	
<b>Processing:</b>			DC removal	
			Dynamic correction	
			Move start time	
			Fk filter	
			Bandpass butterworth	
			Energy decay	

**Table 4-7. Processing steps for borehole radar data from HSH01.**

<b>SITE: SIMPEVARP</b> <b>BH: HSH01</b> <b>TYPE: Dipole</b> <b>Interpret: PN</b>	<b>Logging company: RAYCON</b> <b>Equipment: SKB RAMAC</b> <b>Manufacturer: MALÅ GeoScience</b>			
	<b>Antenna</b>			
		<b>250 MHz</b>	<b>100 MHz</b>	
<b>Processing:</b>		DC removal	DC removal	
		Reverse polarity	Dynamic correction	
		Dynamic correction	Move start time	
		Move start time	Fk filter	
		Fk filter	Bandpass butterworth	
		Energy decay	Energy decay	

**Table 4-8. Processing steps for borehole radar data from HSH02.**

<b>SITE: SIMPEVARP</b> <b>BH: HSH02</b> <b>TYPE: Dipole</b> <b>Interpret: PN</b>	<b>Logging company: RAYCON</b> <b>Equipment: SKB RAMAC</b> <b>Manufacturer: MALÅ GeoScience</b>			
	<b>Antenna</b>			
		<b>250 MHz</b>	<b>100 MHz</b>	
<b>Processing:</b>		DC removal	DC removal	
		Dynamic correction	Dynamic correction	
		Move start time	Move start time	
		Fk filter	Fk filter	
		Bandpass butterworth	Energy decay	
		Energy decay		

**Table 4-9. Processing steps for borehole radar data from HSH03.**

<b>SITE: SIMPEVARP</b> <b>BH: HSH03</b> <b>TYPE: Dipole</b> <b>Interpret: PN</b>	<b>Logging company: RAYCON</b> <b>Equipment: SKB RAMAC</b> <b>Manufacturer: MALÅ GeoScience</b>			
	<b>Antenna</b>			
		<b>250 MHz</b>	<b>100 MHz</b>	
<b>Processing:</b>		DC removal	DC removal	
		Dynamic correction	Dynamic correction	
		Move start time	Move start time	
		Fk filter	Fk filter	
		Bandpass butterworth	Bandpass butterworth	
		Energy decay	Energy decay	

### 4.2.3 BIPS

In percussion-drilled boreholes there are no traces on the borehole walls for calibration of the length measuring devices and, therefore, no depth adjustment is performed.

The visualization of data is made with BDPP, a Windows based processing software for filtering, presentation and analyzing of BIPS data. No fracture mapping of the BIPS image was performed. Raw data was delivered on a CD together with printable pictures in pdf format before the field crew left the site.



## **5 Results and data delivery**

Rawdata from the measurements were delivered directly after the termination of the field activities. As regards the BIPS data this was the final delivery. The geophysical logging data have been calibrated and adjusted before the final delivery. RAMAC radar data has been interpreted and the results of the interpretation delivered.

The delivered data have been inserted in the database (SICADA) of SKB. The SICADA reference to the present activity is Field note No 12.

### **5.1 Wellmac logging**

The results from the Wellmac logging are delivered to SKB on a CD. The data on the CD consist of ascii files for each borehole and method and WellCad files. Moreover, printable pictures in pdf format from WellCad are also delivered on the CD.

The results from the Wellmac logging are presented in Appendix 1. The individual runs are adjusted for recording errors of the depth based on the gamma measurements. On the printouts in Appendix 1, an average filter over 3 measuring points is applied to the gamma and density readings.

Data from the Normal 1.6 logging are not delivered due to poor quality. Normal 1.6 was disqualified because of the bad correlation to the Normal 0.4. This depends probably on the small diameter of the Wellmac probes, as compared to the borehole diameter, in combination with the partly high salinity of the borehole fluid.

### **5.2 RAMAC Radar**

The results of the interpretation of radar measurements are presented in Table 5.2–5.5 below and radar data are visualized in Appendix 2. It should be remembered that the images in Appendix 2 are only composite pictures of all events, 360 degrees around the borehole, and do not reflect the orientation of the structures.

Only the larger, clearly visible, structures are interpreted in Radinter SKB. A number of minor structures also exists, as indicated in Appendix 2. It should also be pointed out that reflections interpreted would always get an intersection point with the borehole, but being located further away, they may in some cases not reach the borehole.

The data quality (as seen in Appendix 2) from KSH01A, HSH01, HSH02 and HSH03 is in some parts relatively satisfying, but in other parts of lower quality due to more conductive conditions. A conductive environment makes the radar wave attenuating which decreases the penetration.

As also seen in Appendix 2 the resolution and penetration of radar waves depend of the antenna frequency used. Low antenna frequency gives less resolution but higher penetration compared to a higher frequency

The distribution of the identified structures is shown in Table 5-1. As seen in the table, the structures are quite evenly distributed.

**Table 5-1. Distribution of identified structures.**

<b>Distribution of identified structures</b>				
Site: <b>Simpevarp</b>				
<b>Depth</b>	<b>KSH01A</b>	<b>HSH01</b>	<b>HSH02</b>	<b>HSH03</b>
0 – 50	2	4	2	1
50 – 100	1	4	3	1
100 – 150		4	2	5
150 – 200		2	2	3

As seen in Appendix 2 the listed structures can be identified in the data from more than one antenna frequency. Note the negative intersection depth, pointing at structures more or less parallel to the borehole.

**Table 5-2. KSH01A, model information from dipole antennas 100 MHz.**

<b>RADINTER MODEL INFORMATION</b>				
(100 MHz Dipole Antennas)				
Site: <b>Simpevarp</b>				
Borehole name: <b>KSH01A</b>				
Nominal velocity 120.00 (m/μs):				
<b>Object type</b>	<b>Name</b>	<b>Intersection depth</b>	<b>Dip</b>	<b>Width</b>
PLANE	A	-10.56	13.02	
PLANE	B	48.08	19.97	
PLANE	C	49.28	25.05	
PLANE	D	14.42	14.61	
PLANE	E	89.17	23.66	

Names in table according to Appendix 2.

**Table 5-3. HSH01, model information from dipole antennas 100 and 250 MHz.**

<b>RADINTER MODEL INFORMATION</b>				
(100 and 250 MHz Dipole Antennas)				
Site:		<b>Simpevarp</b>		
Borehole name:		<b>HSH01</b>		
Nominal velocity (m/us):		120.00		
Object type	Name	Intersection depth	Dip	Width
PLANE	A	38.89	18.73	
PLANE	B	36.55	49.26	
PLANE	C	8.29	37.60	
PLANE	D	16.40	33.70	
PLANE	E	70.39	32.15	
PLANE	F	87.58	24.96	
PLANE	G	112.59	22.70	
PLANE	I	86.96	26.72	
PLANE	J	152.10	40.59	
PLANE	K	167.68	38.70	
PLANE	M	179.17	27.33	

Names in table according to Appendix 2.

**Table 5-4. HSH02, model information from dipole antennas 100 and 250 MHz.**

<b>RADINTER MODEL INFORMATION</b>				
(100 and 250 MHz Dipole Antennas)				
Site:		<b>Simpevarp</b>		
Borehole name:		<b>HSH02</b>		
Nominal velocity (m/us):		120.00		
Object type	Name	Intersection depth	Dip	Width
PLANE	A	28.27	51.57	
PLANE	B	33.24	33.95	
PLANE	C	55.65	38.42	
PLANE	D	111.78	28.12	
PLANE	E	106.52	30.73	
PLANE	F	143.22	23.51	
PLANE	G	171.90	29.48	

Names in table according to Appendix 2.

**Table 5-5. HSH03, model information from dipole antennas 100 and 250 MHz.**

<b>RADINTER MODEL INFORMATION</b>				
(100 and 250 MHz Dipole Antennas)				
Site:		<b>Simpevarp</b>		
Borehole name:		<b>HSH03</b>		
Nominal velocity (m/ $\mu$ s):		120.00		
<b>Object type</b>	<b>Name</b>	<b>Intersection depth</b>	<b>Dip</b>	<b>Width</b>
PLANE	A	54.42	22.02	
PLANE	B	68.78	52.02	
PLANE	C	106.97	41.69	
PLANE	D	128.44	52.48	
PLANE	E	109.77	14.04	
PLANE	F	150.55	21.72	
PLANE	G	144.96	36.47	
PLANE	H	138.14	30.65	
PLANE	I	187.53	20.20	

Names in table according to Appendix 2.

In Appendix 2, the amplitude of the first arrival is plotted against the depth, for the 250 MHz dipole antennas. The amplitude variation along the borehole indicates changes in conductivity of the material. A decrease in this amplitude may indicate fractures or crushed zones with higher water content. This decrease in amplitude corresponds partly to the depths where the highest numbers of identified structures are found.

### **5.3 BIPS**

The results from the BIPS measurements were delivered to SKB on a CD together with printable pictures in pdf format before the field crew left the site. Used scale for the pdf-files is 4 metres of BIPS images / A4. In Appendix 3A the BIPS results from the upper part of KSH01A, in Appendix 3B the BIPS results from HSH01, in Appendix 3C the BIPS results from HSH02 and in Appendix 3D the BIPS results from HSH03 is presented respectively.

Geophysical logging, Wellmac in boreholes KSH01A  
(0–100 m), HSH01, HSH02 and HSH03

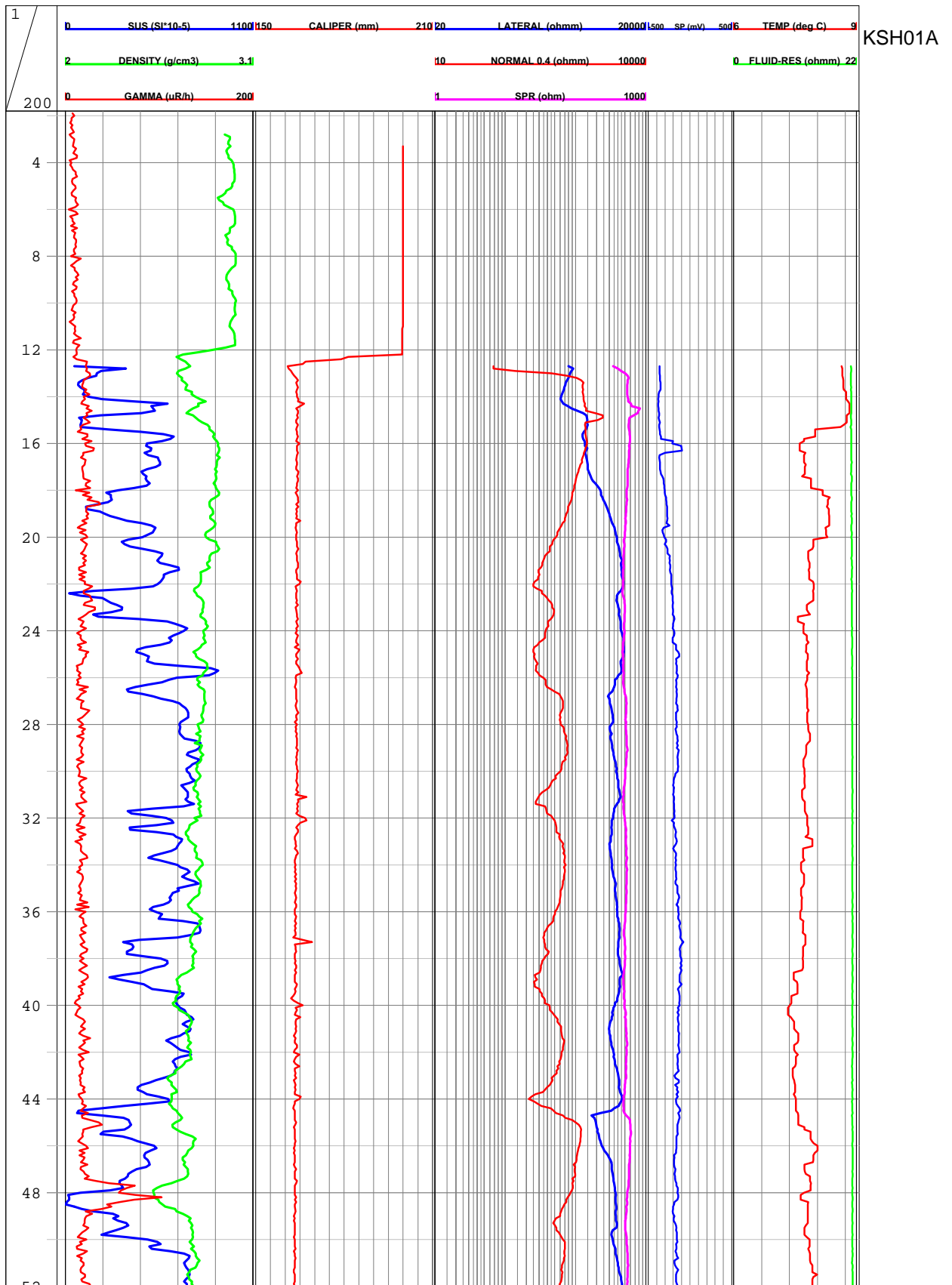

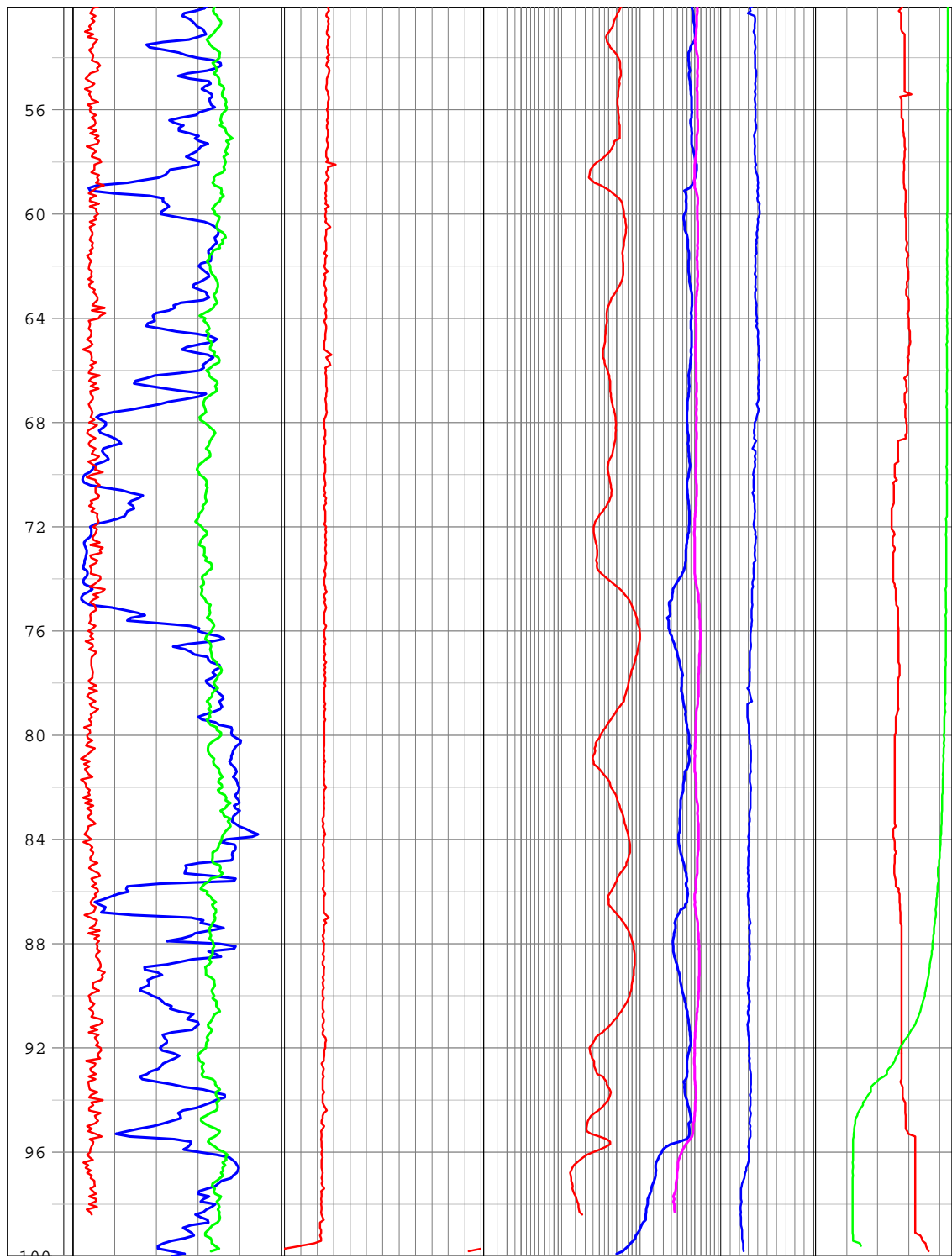

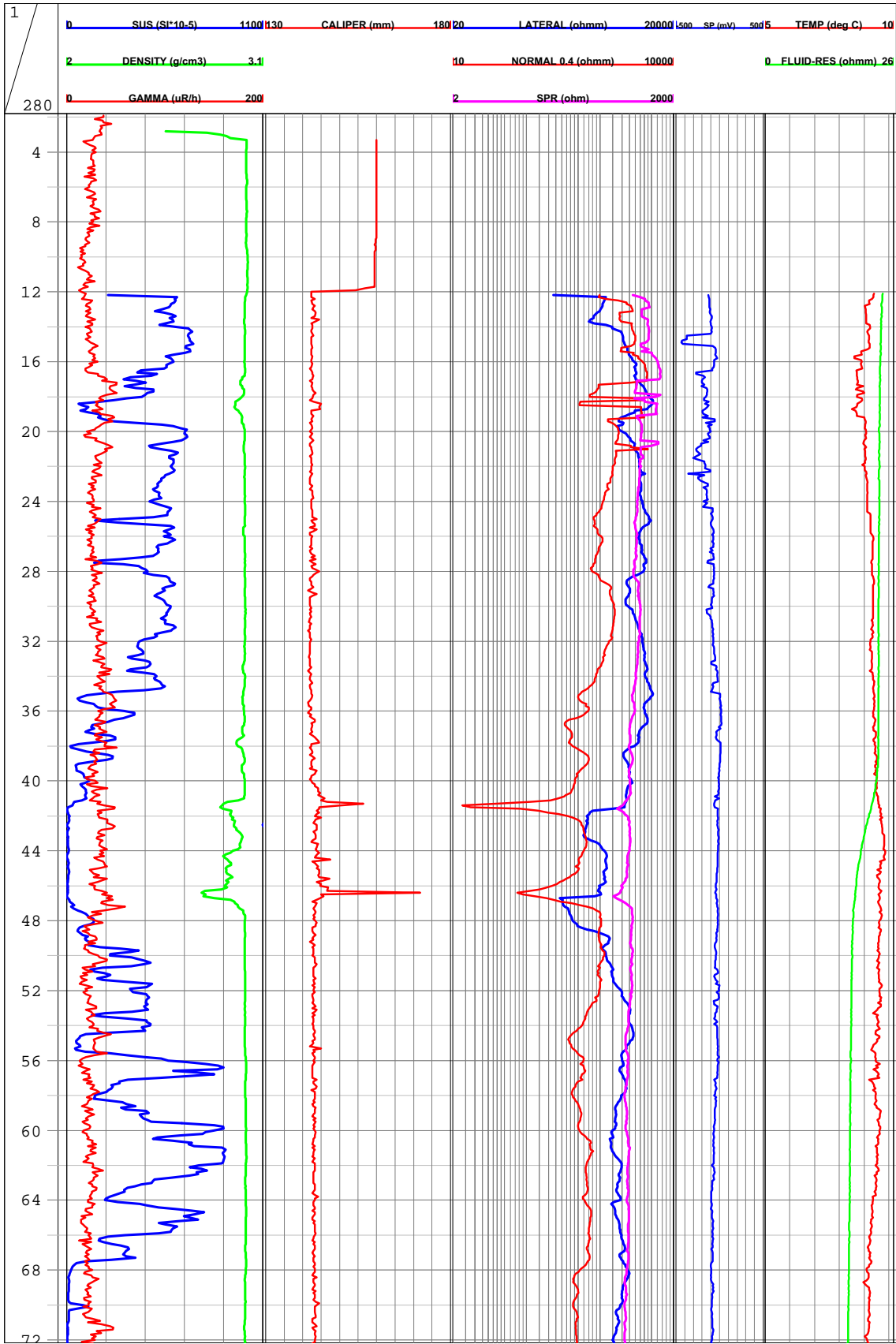

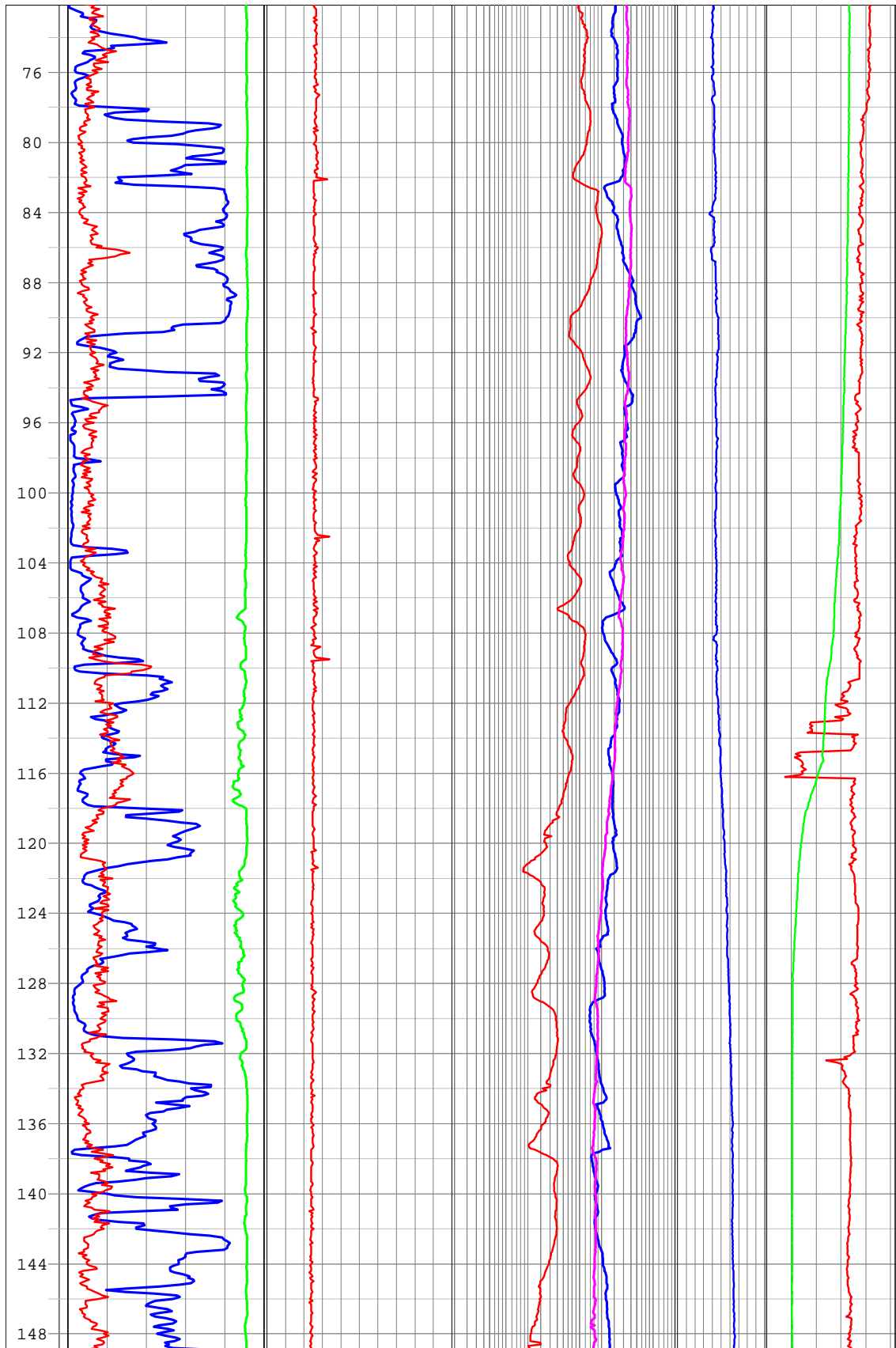



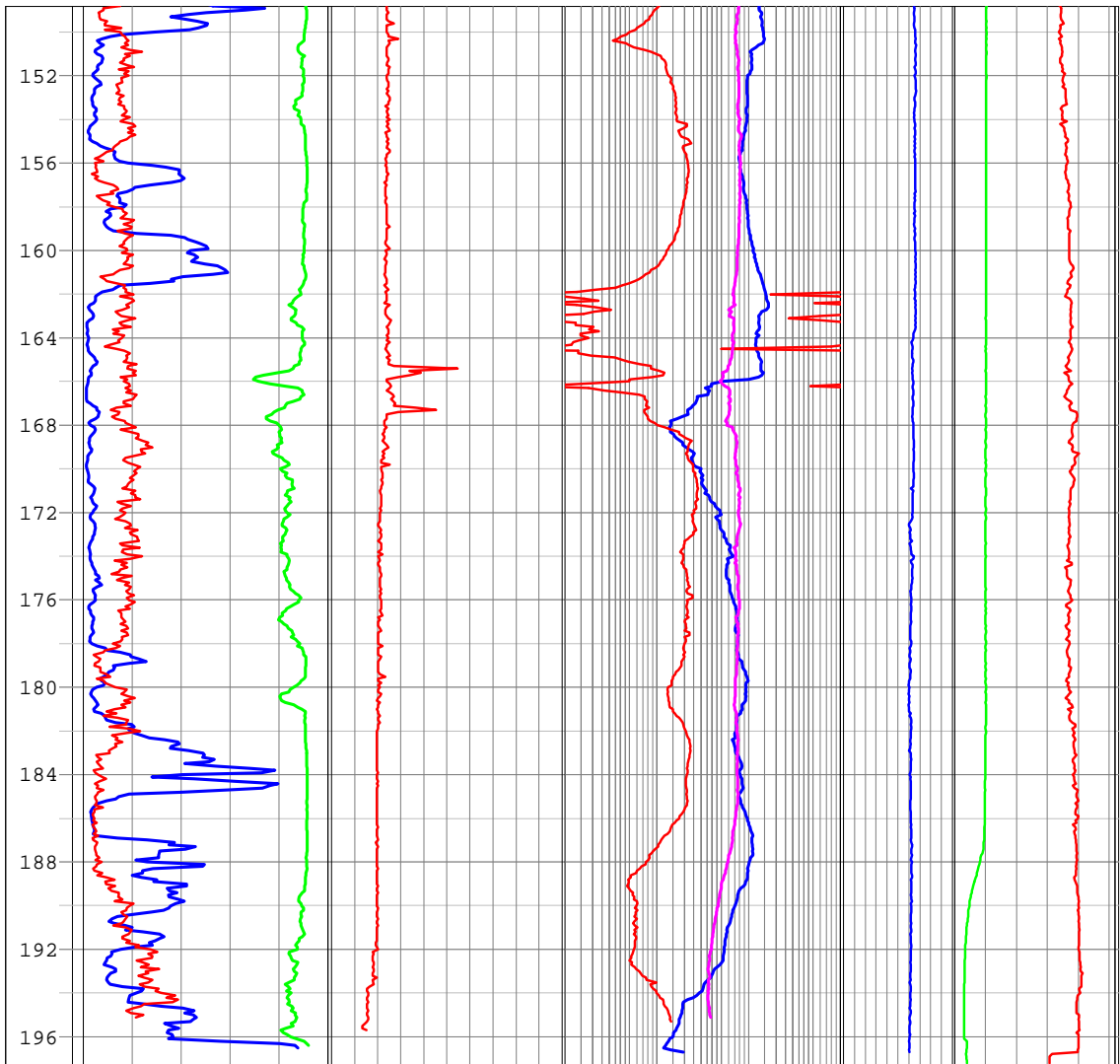

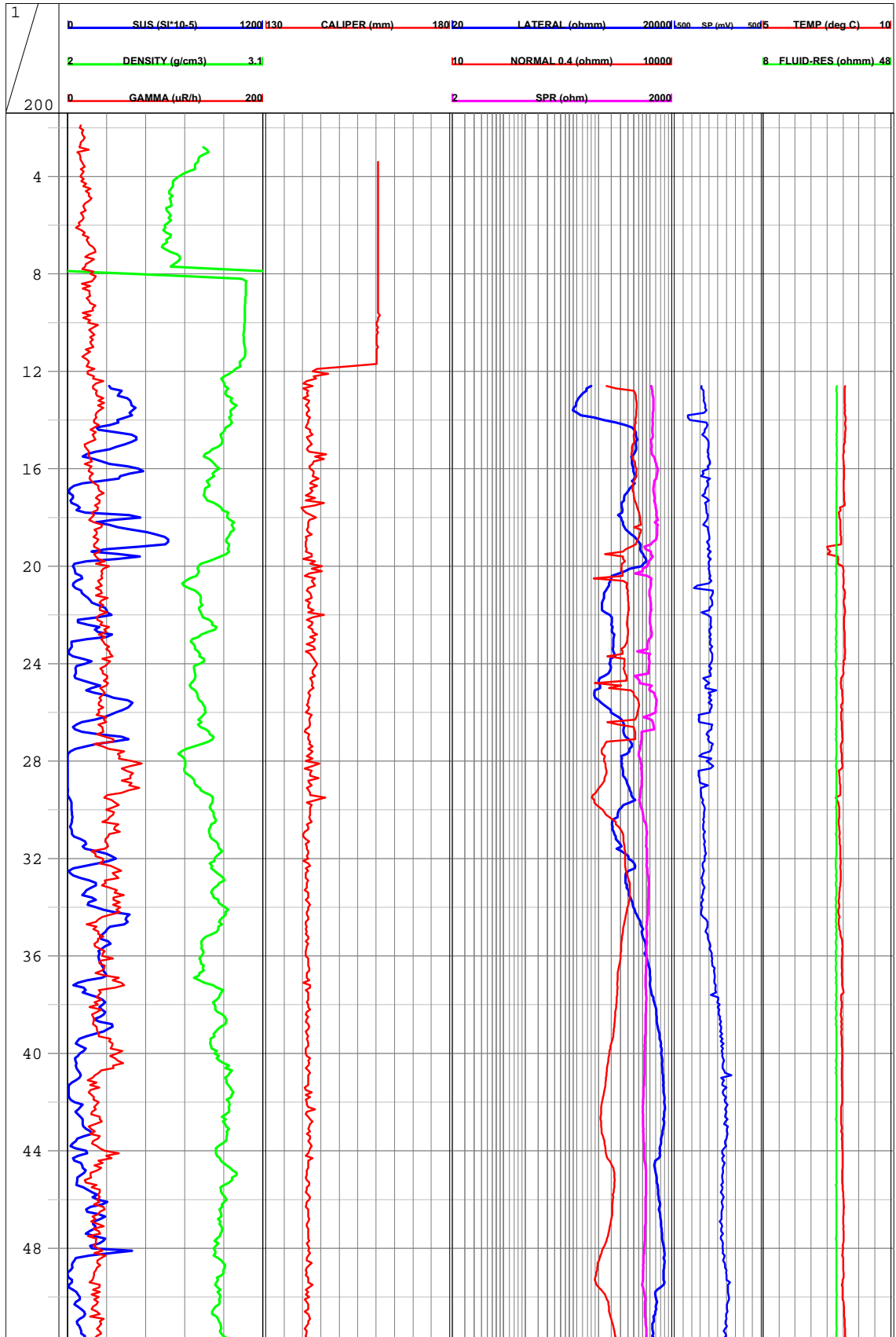

HSH02

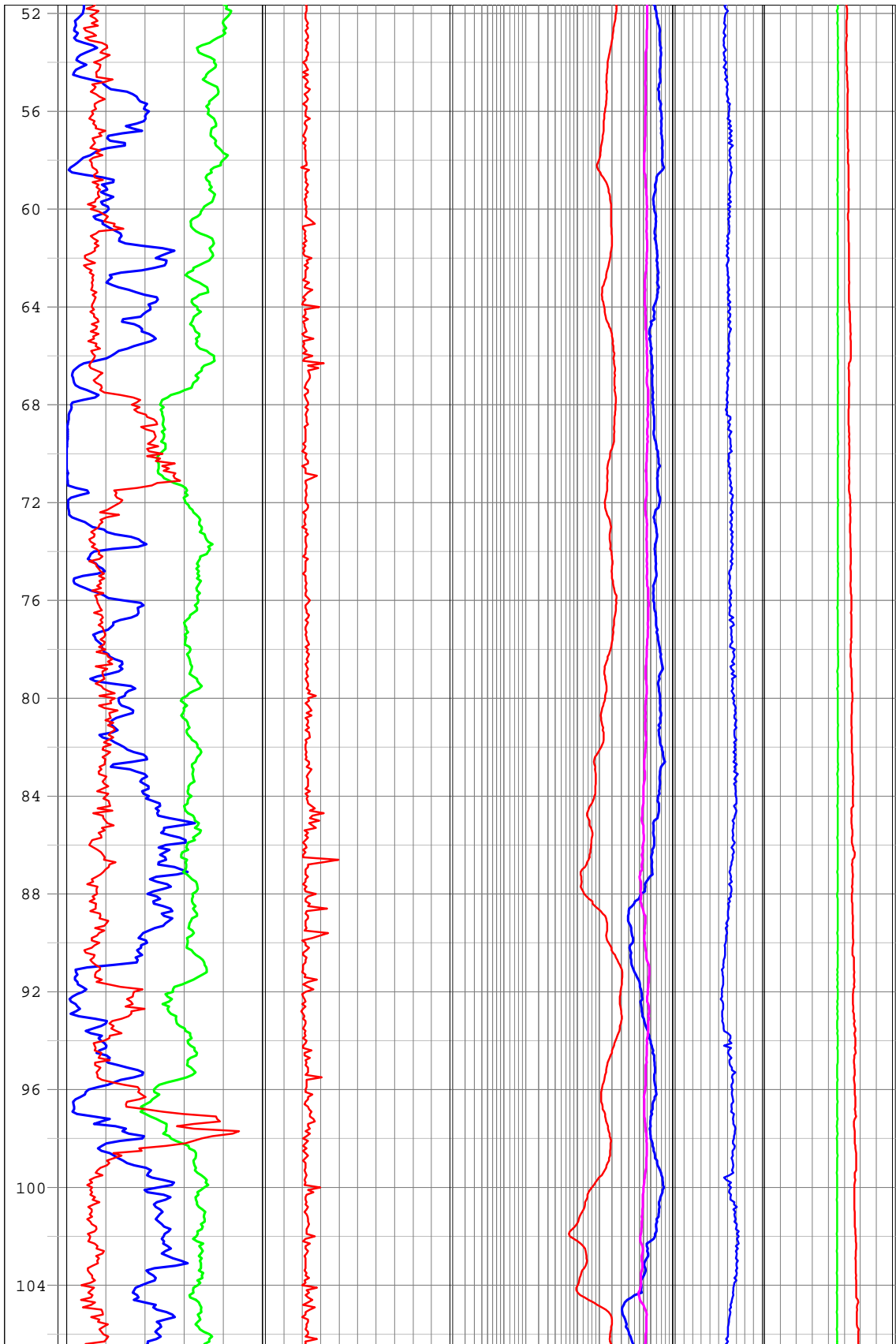

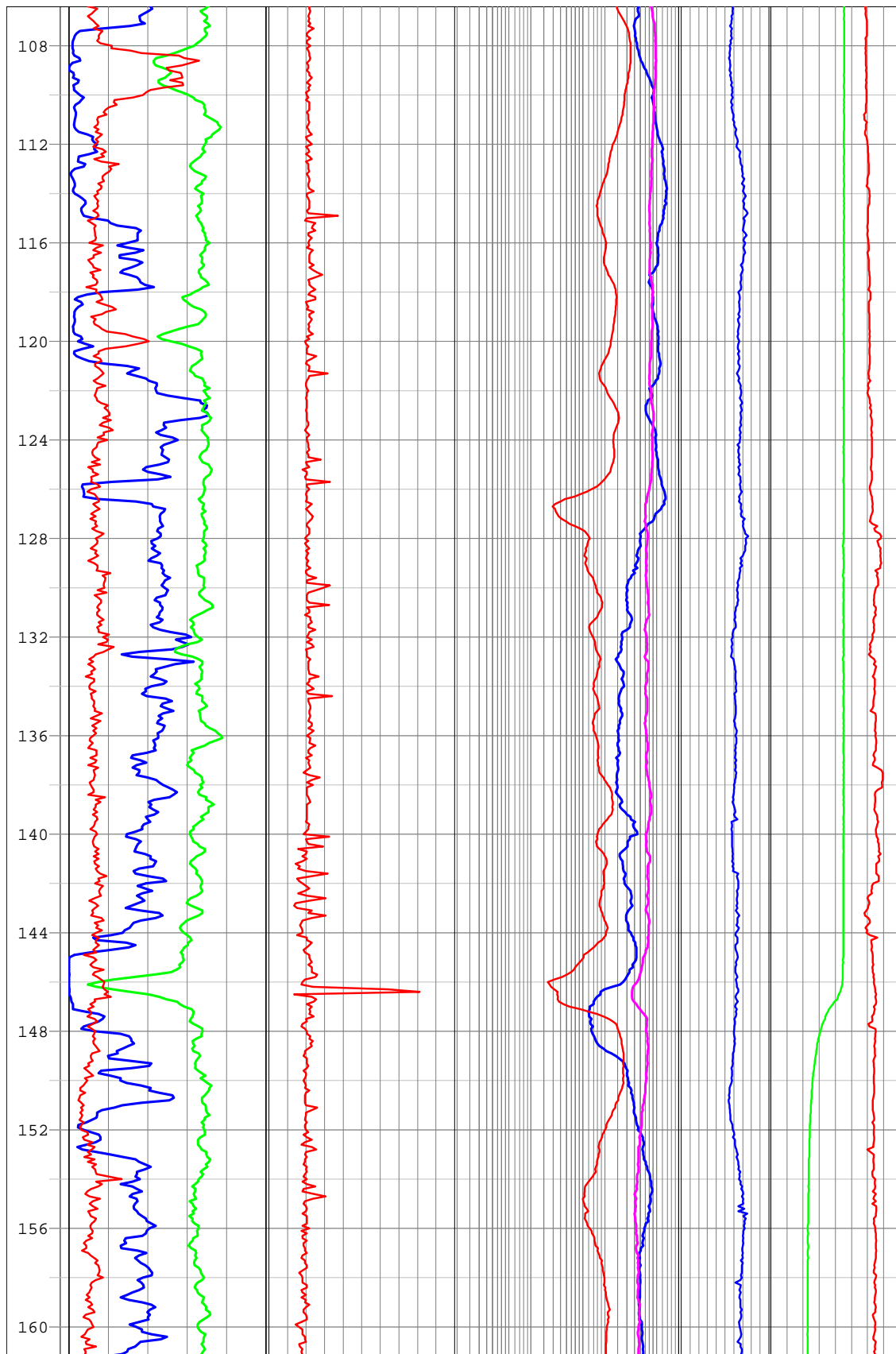

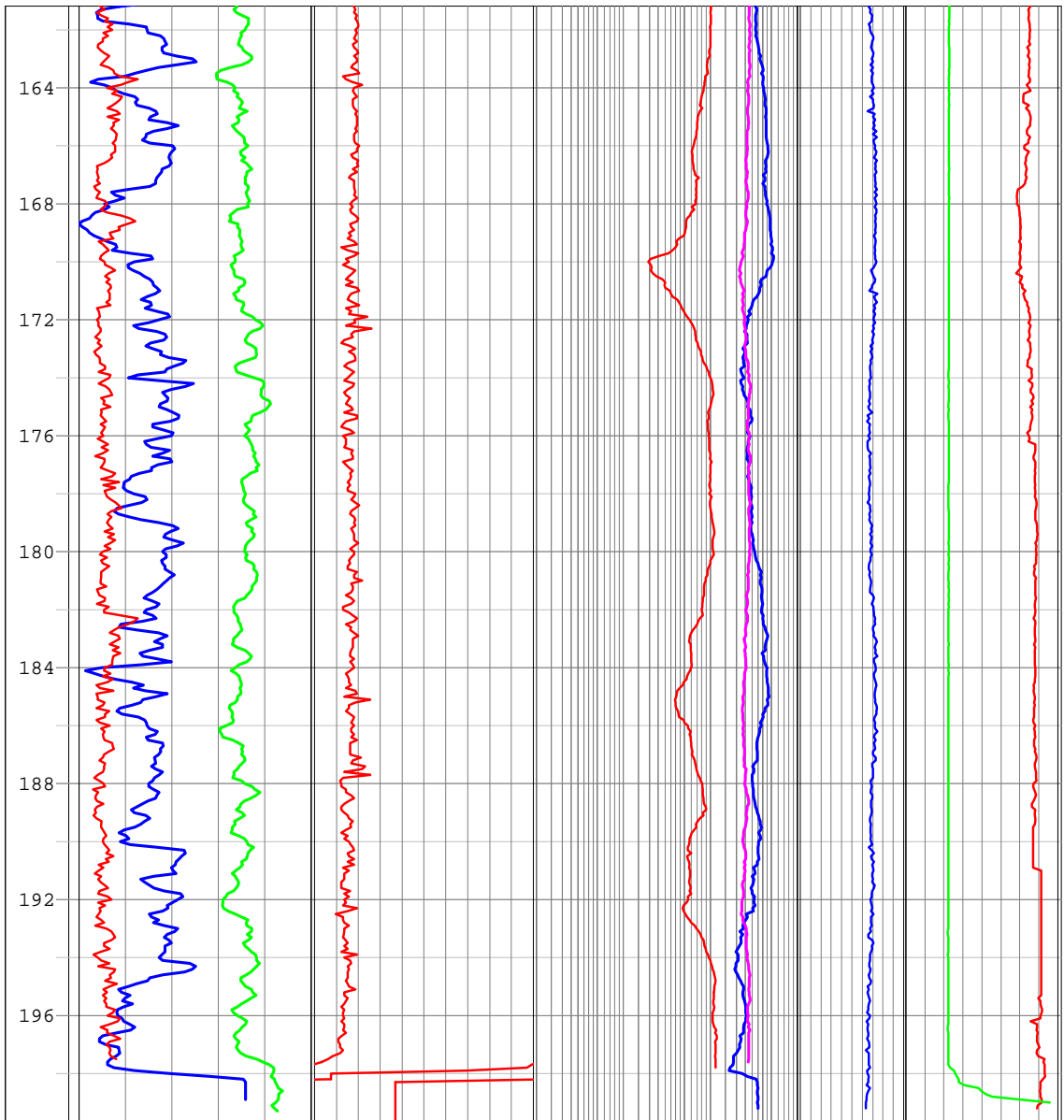

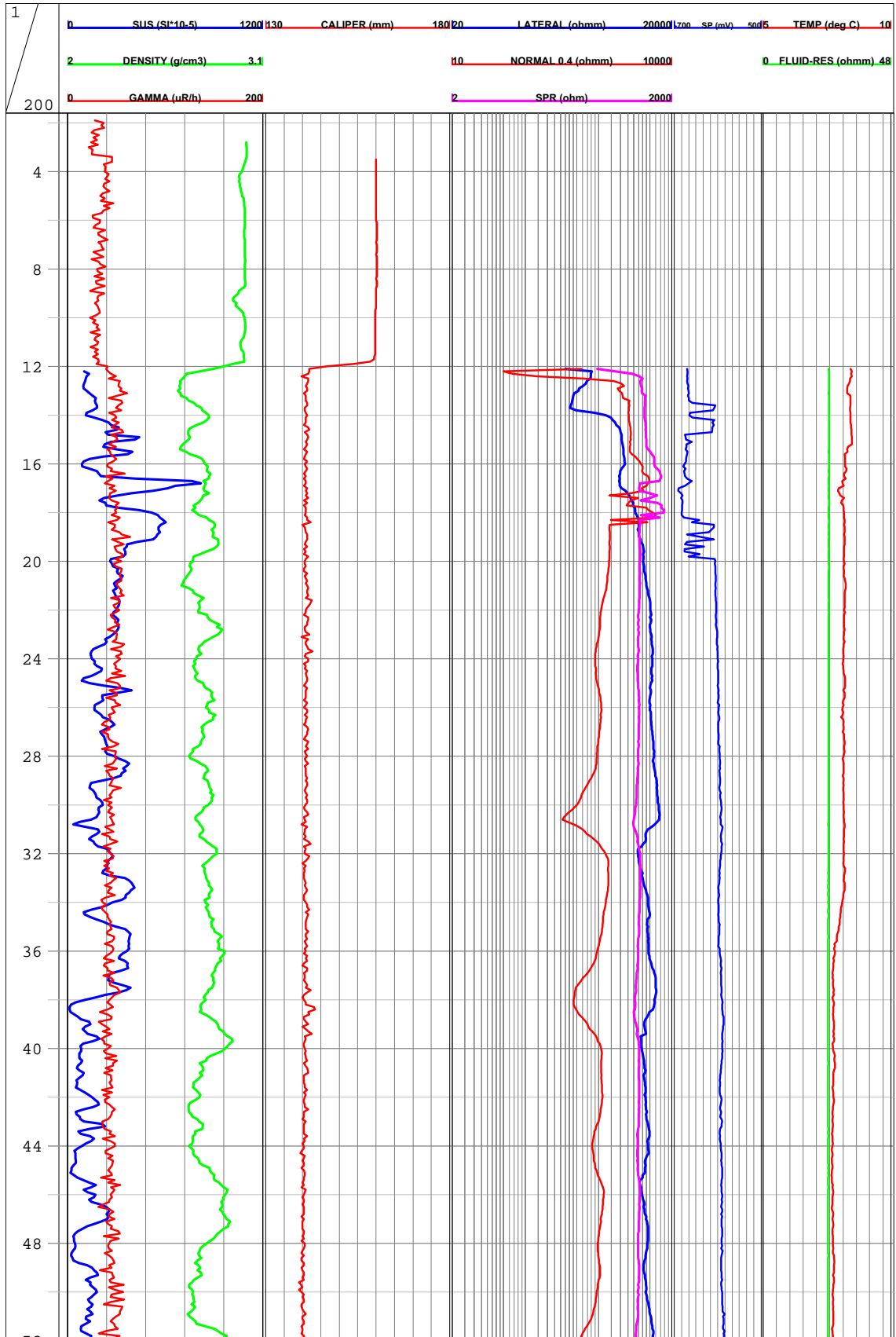

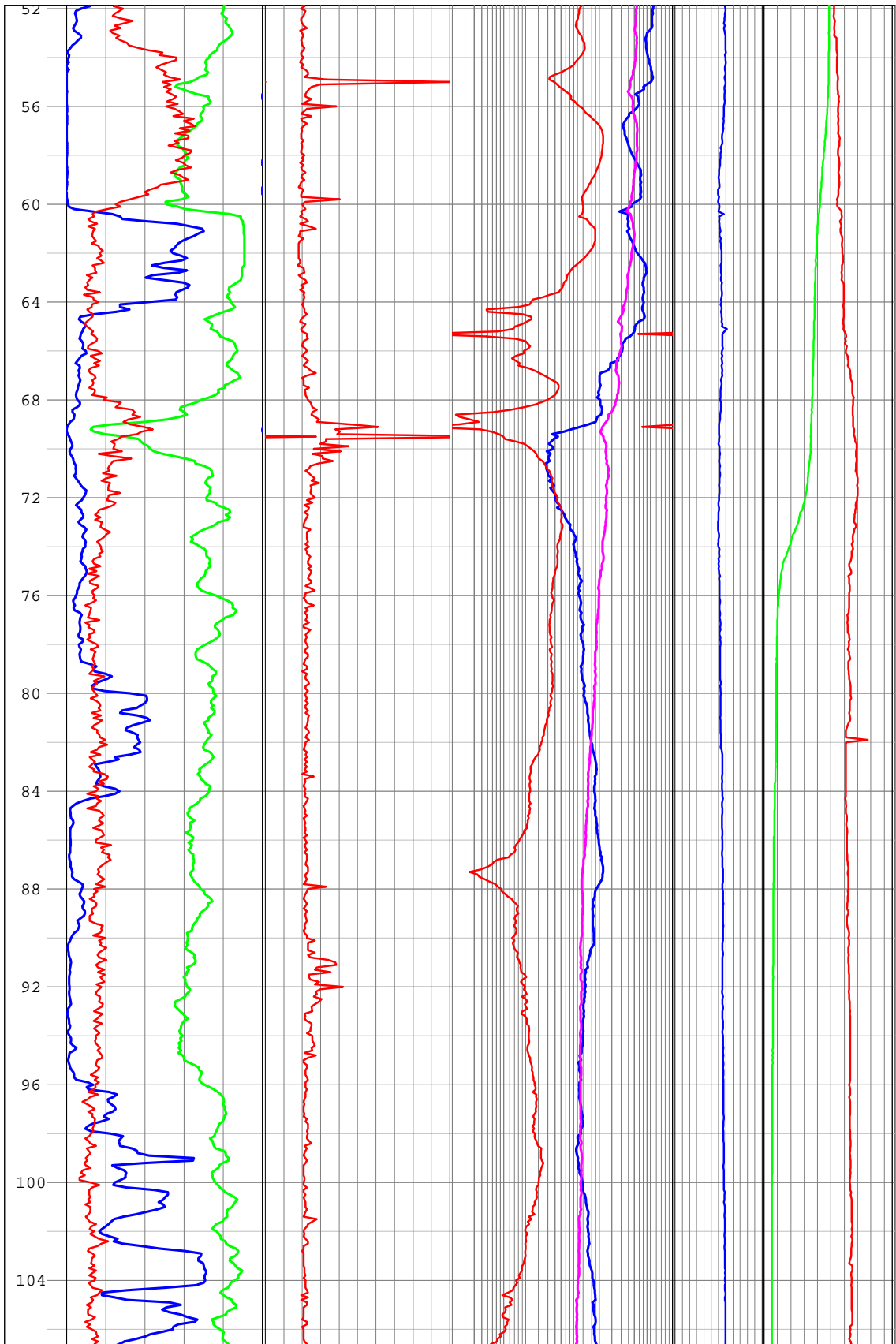

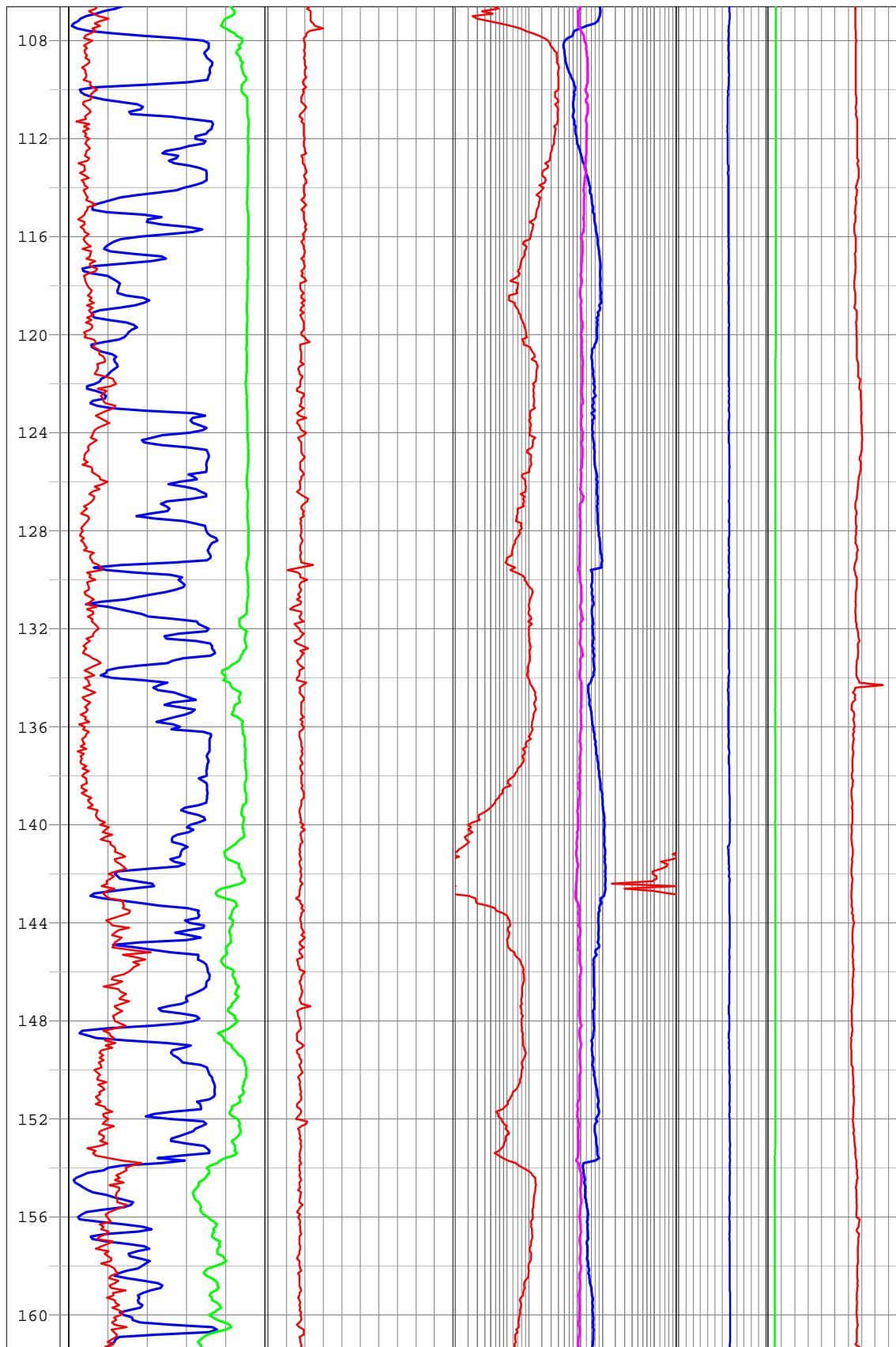



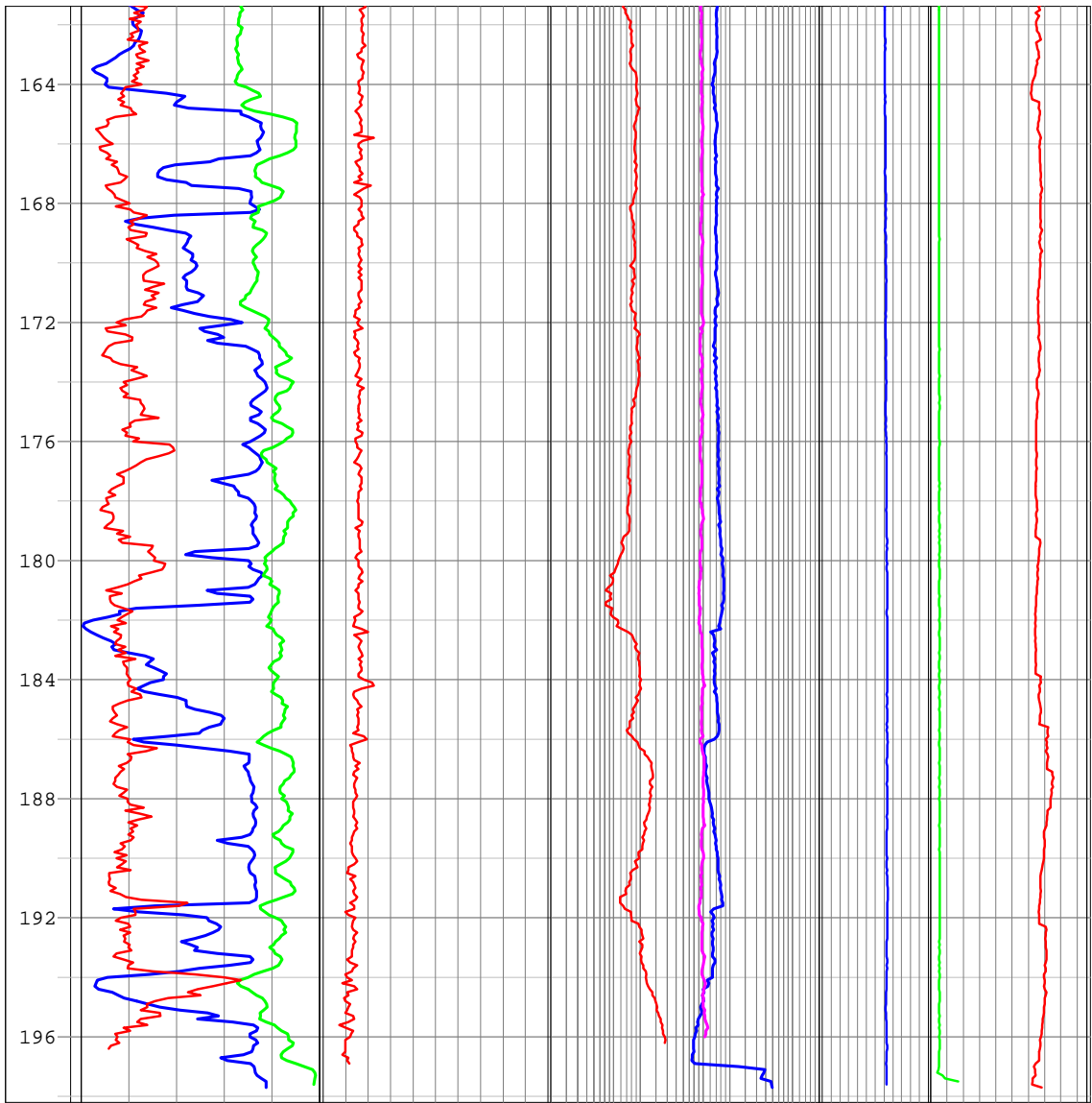

**Radar logging dipole antennas 100 and 250 MHz in boreholes KSH01A (0–100 m), HSH01, HSH02 and HSH03**

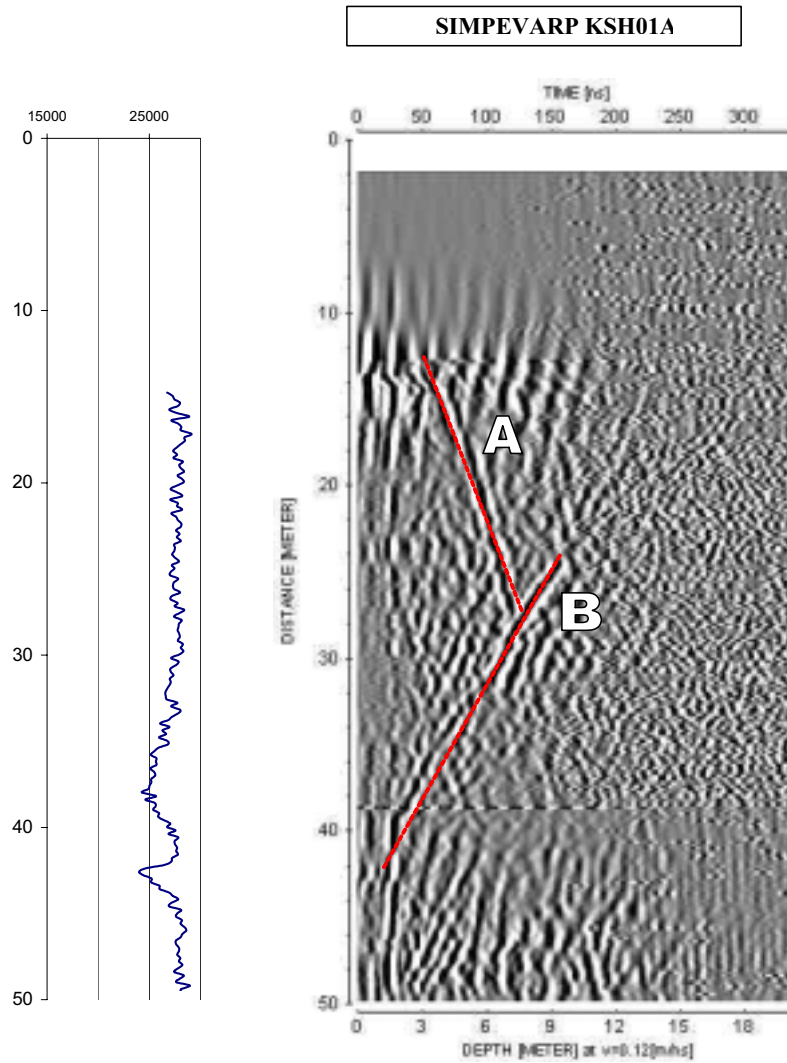

**Amplitude of first wave**

**100 MHz**

**SIMPEVARP KSH01A**

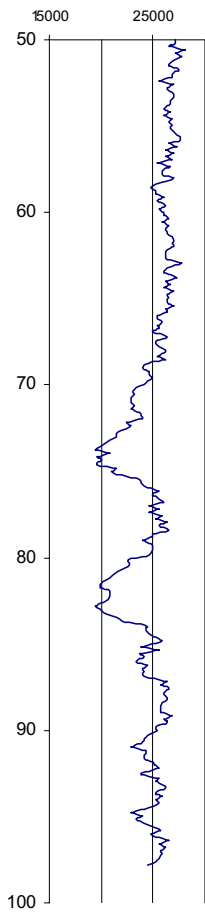

**Amplitude of first wave**

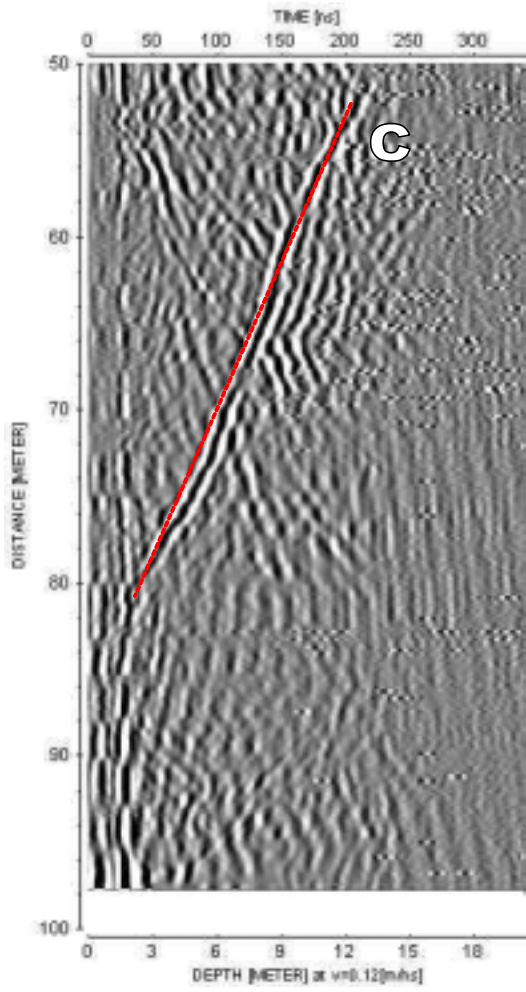

**100 MHz**

SIMPEVARP HSH01

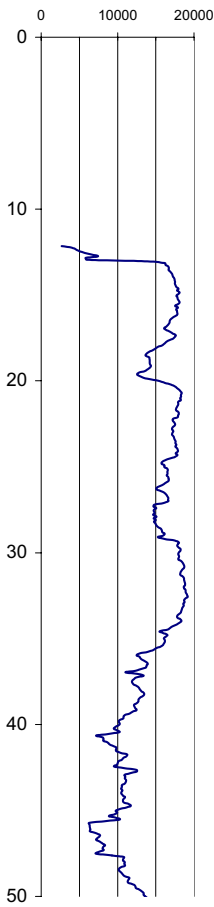

Amplitude of first wave

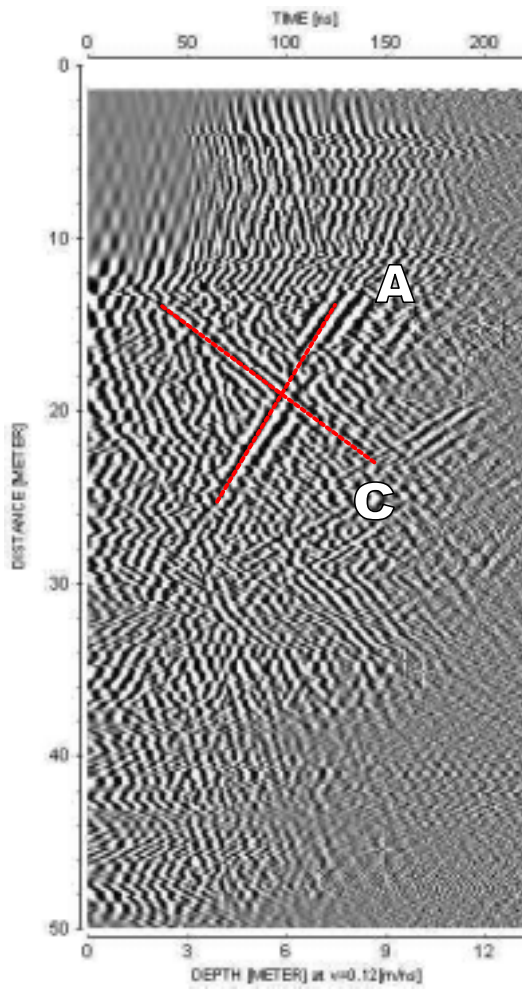

250 MHz

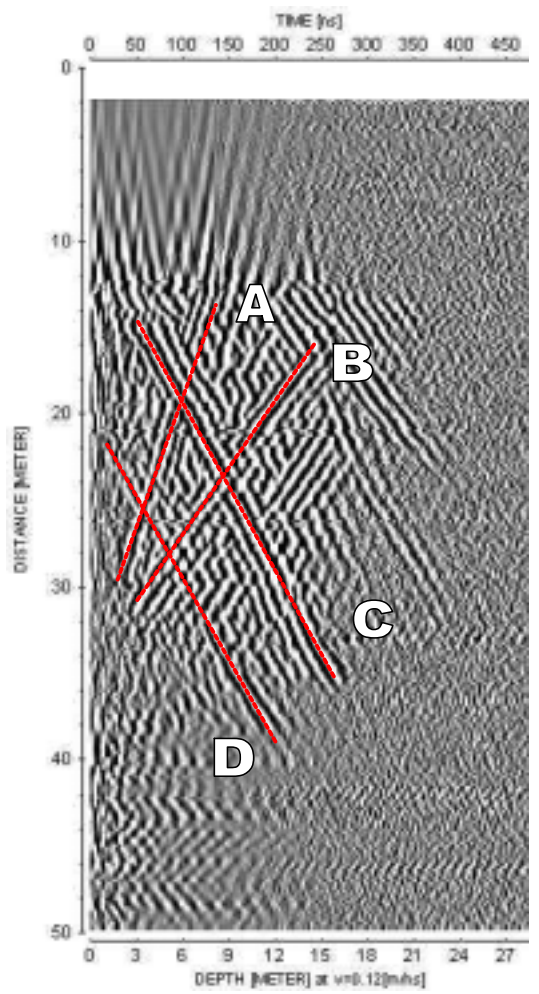

100 MHz

**SIMPEVARP HSH01**

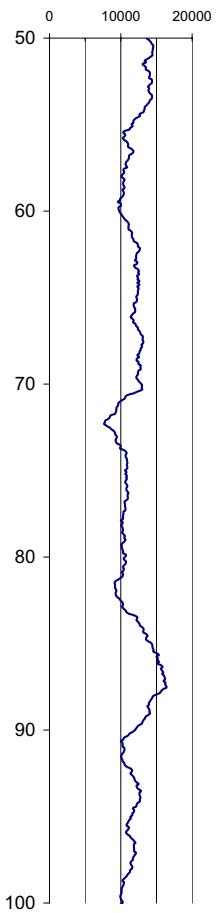

**Amplitude of first wave**

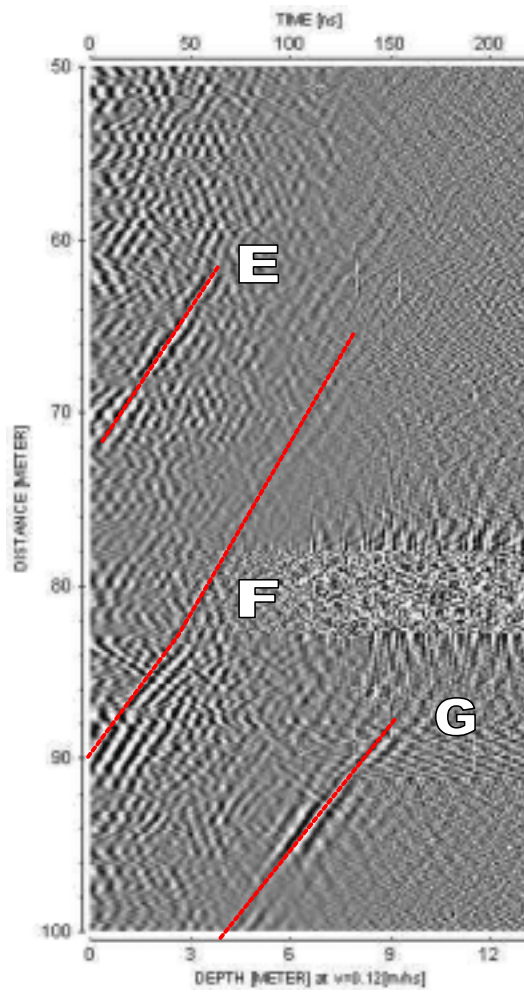

**250 MHz**

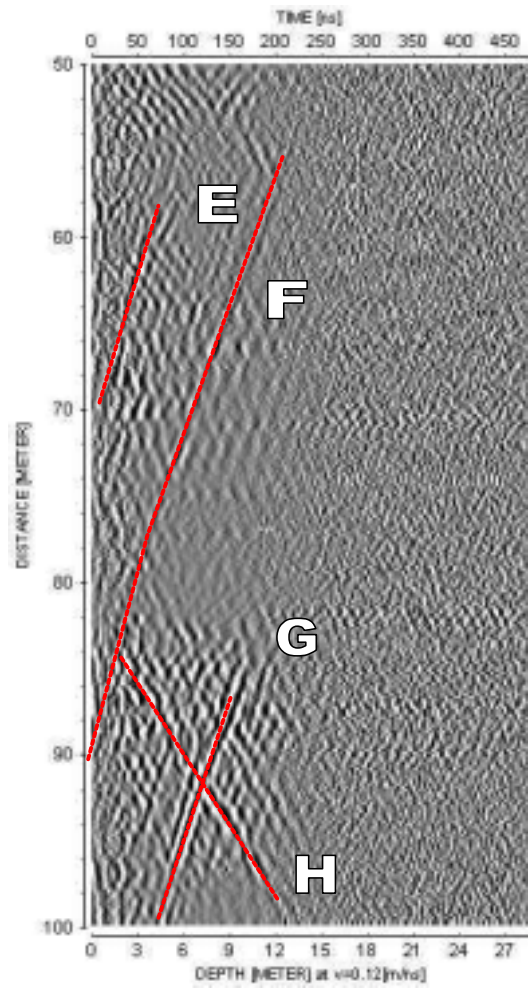

**100 MHz**



SIMPEVARP HSH01

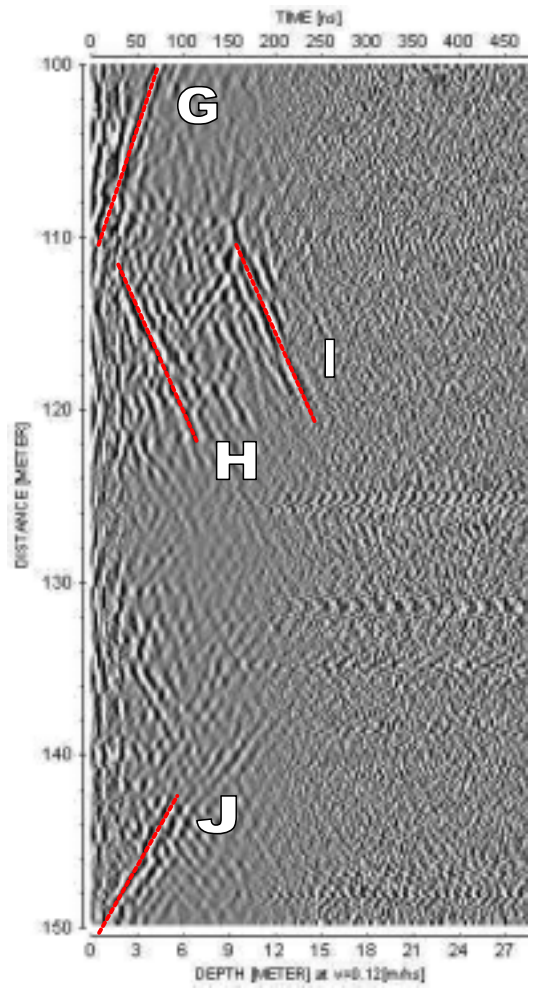
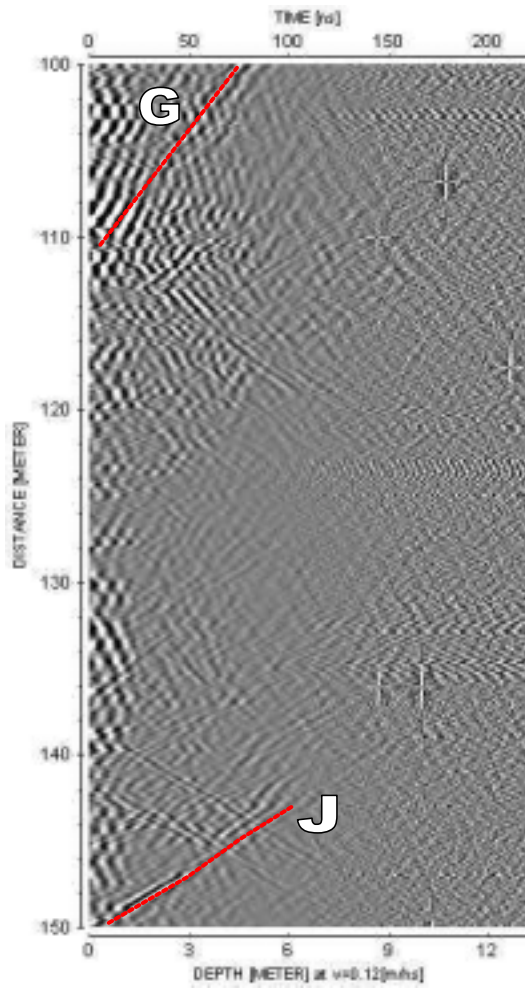
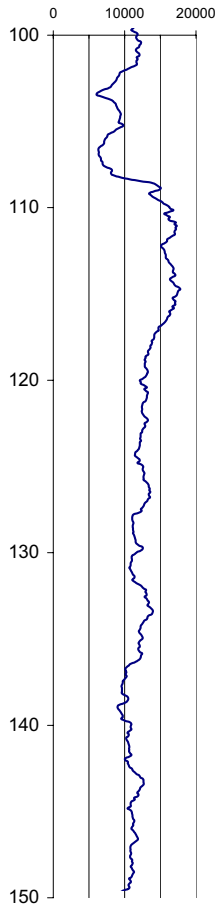

Amplitude of first wave

250 MHz

100 MHz

SIMPEVARP HSH01

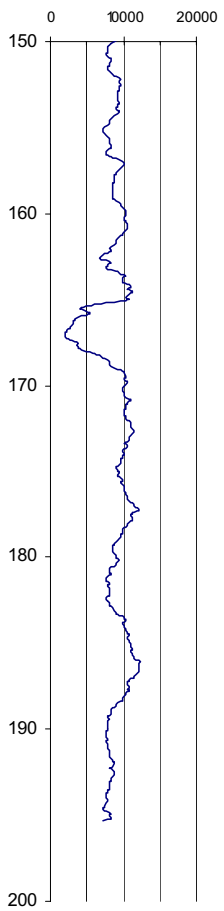

Amplitude of first wave

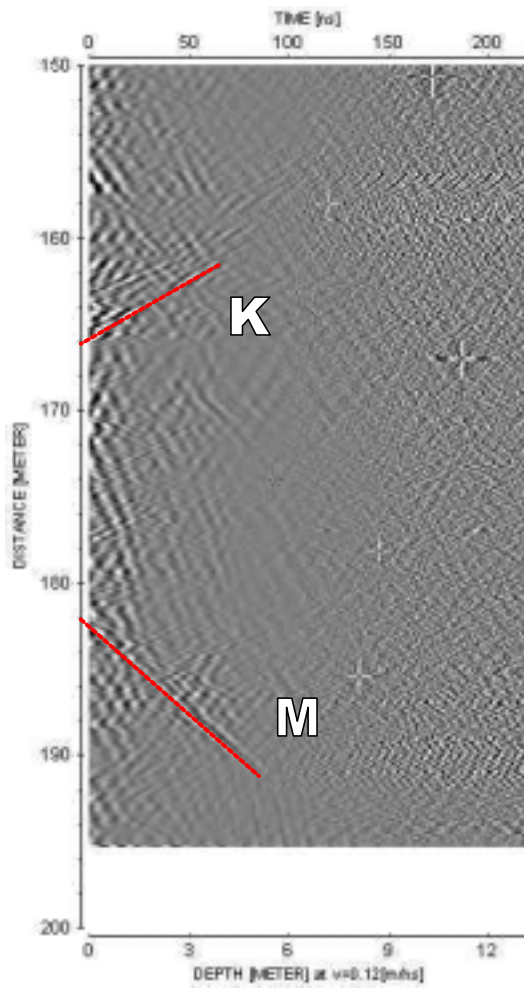

250 MHz

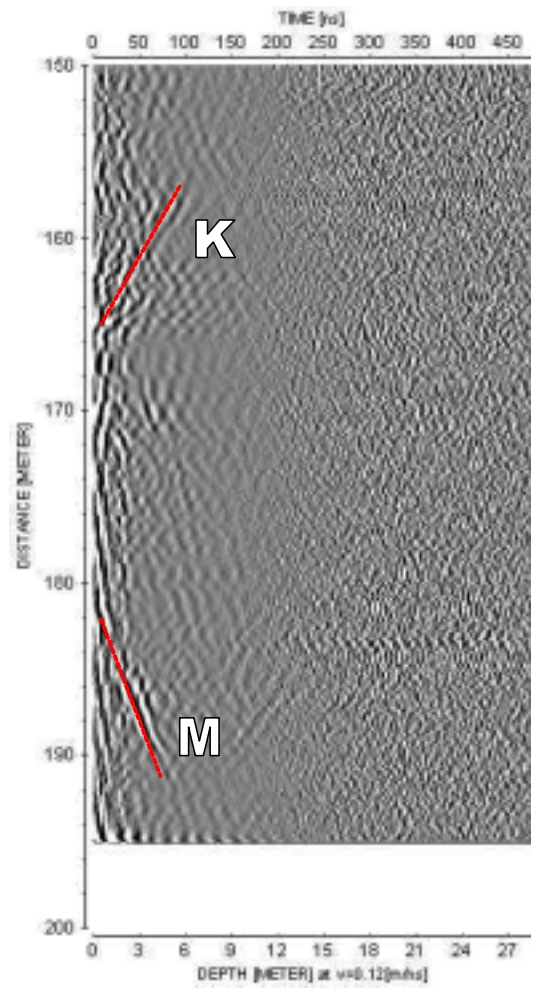

100 MHz

**SIMPEVARP HSH02**

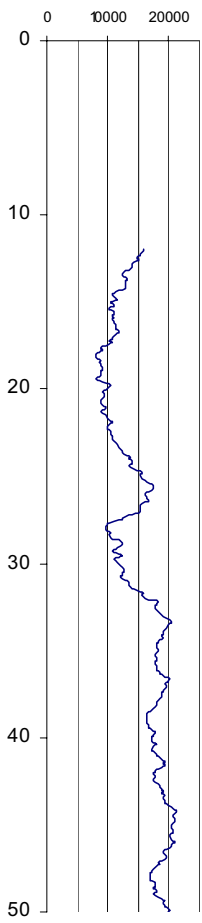

**Amplitude of first wave**

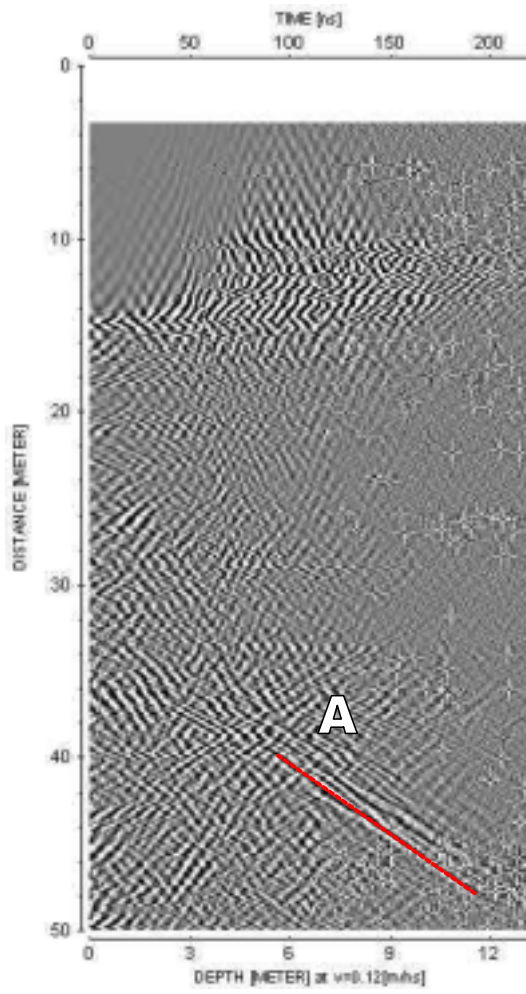

**250 MHz**

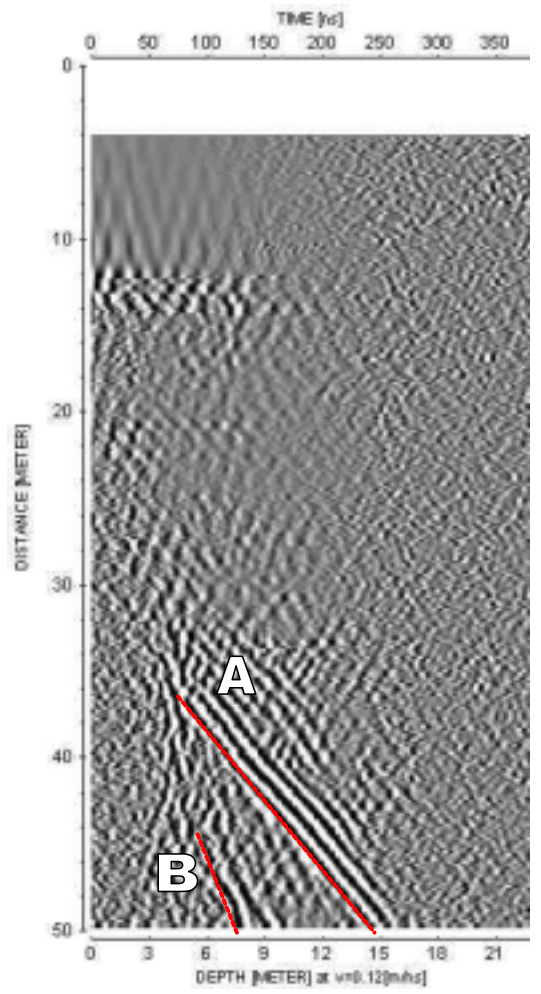

**100 MHz**



SIMPEVARP HSH02

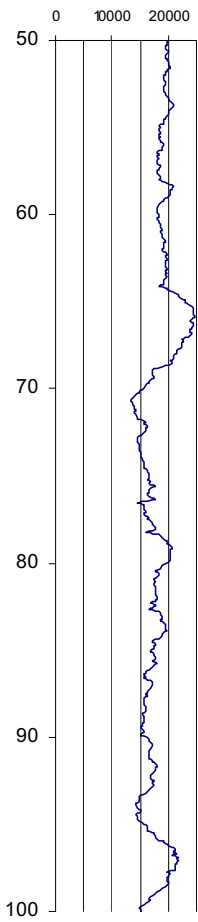

Amplitude of first wave

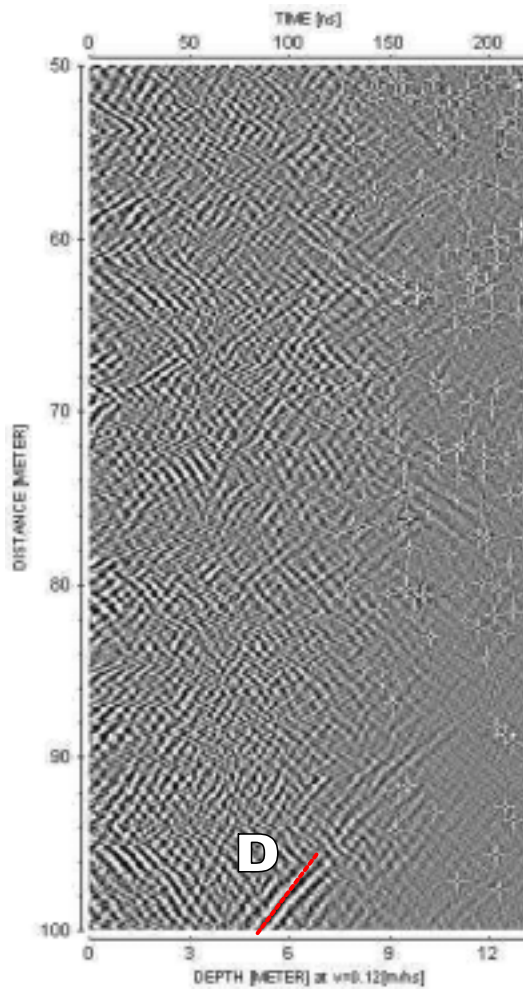

250 MHz

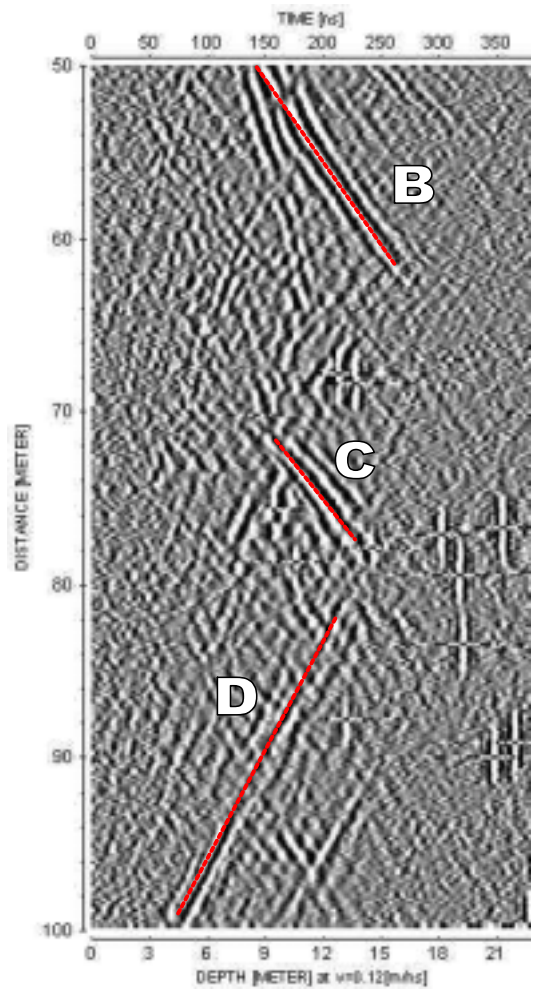

100 MHz

SIMPEVARP HSH02

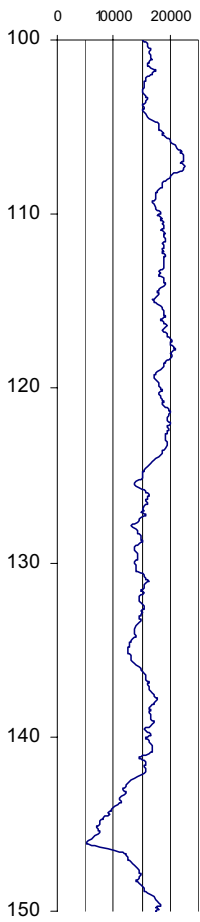

Amplitude of first wave

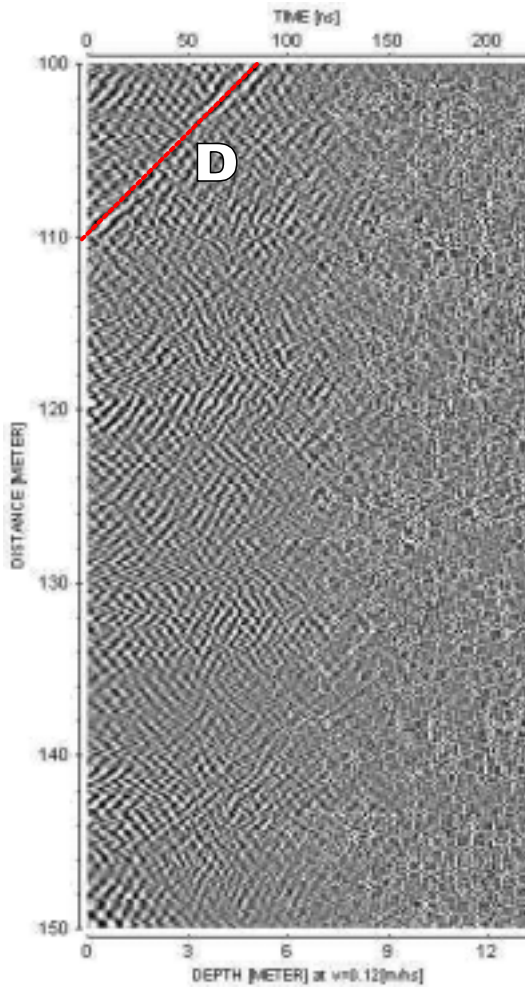

250 MHz

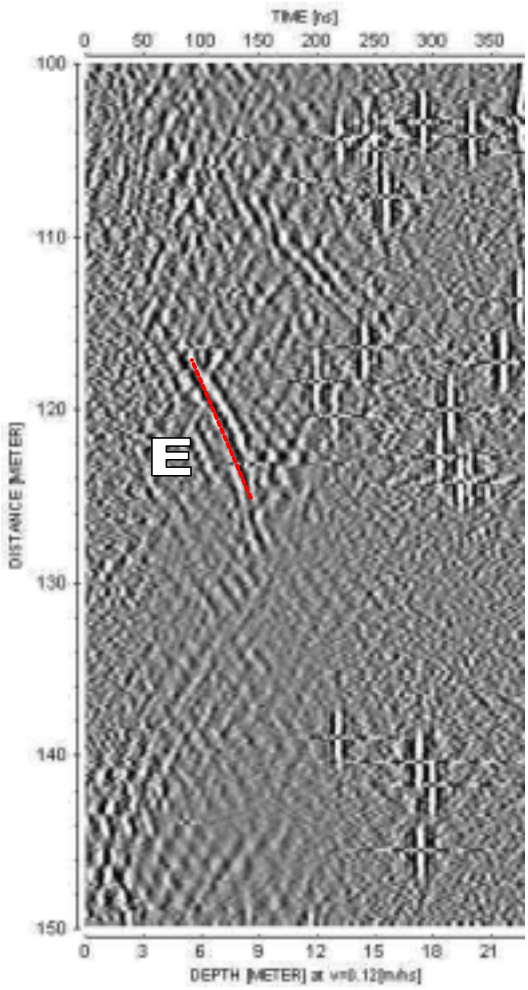

100 MHz

SIMPEVARP HSH02

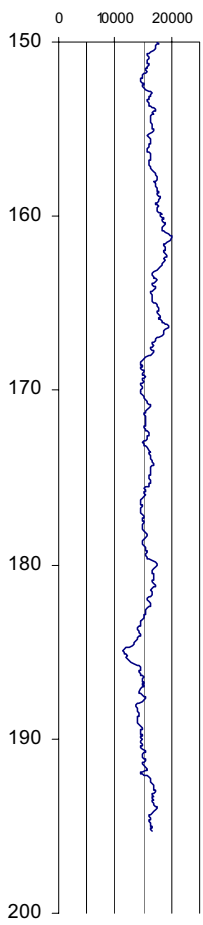

Amplitude of first wave

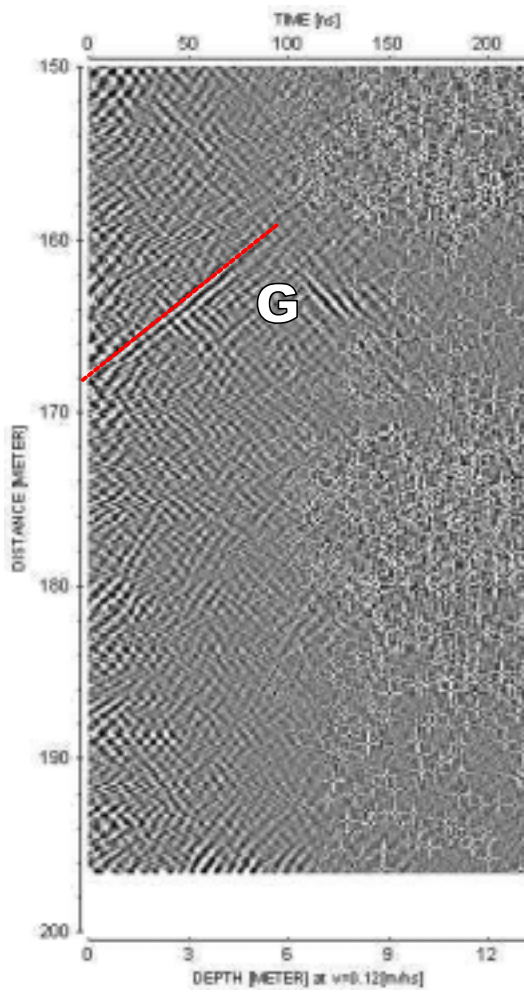

25 MHz

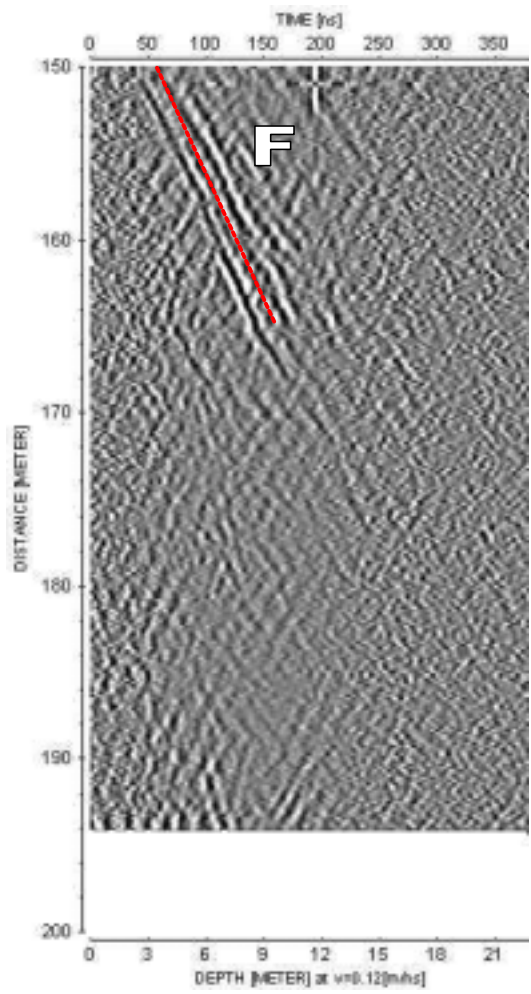

100 MHz



**SIMPEVARP HSH03**

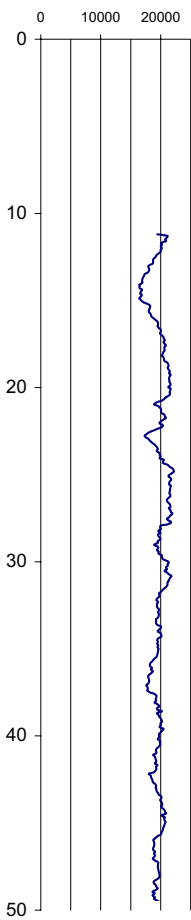

**Amplitude of first wave**

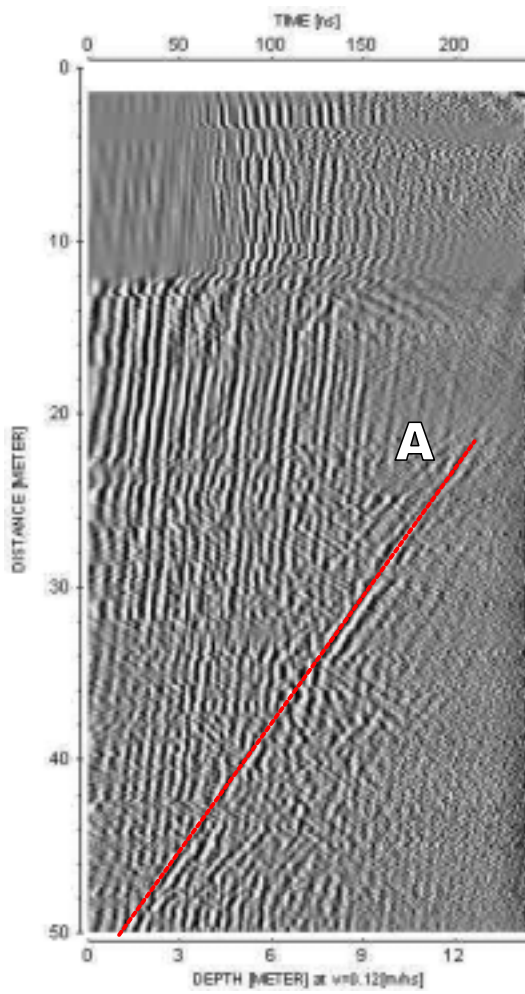

**250 MHz**

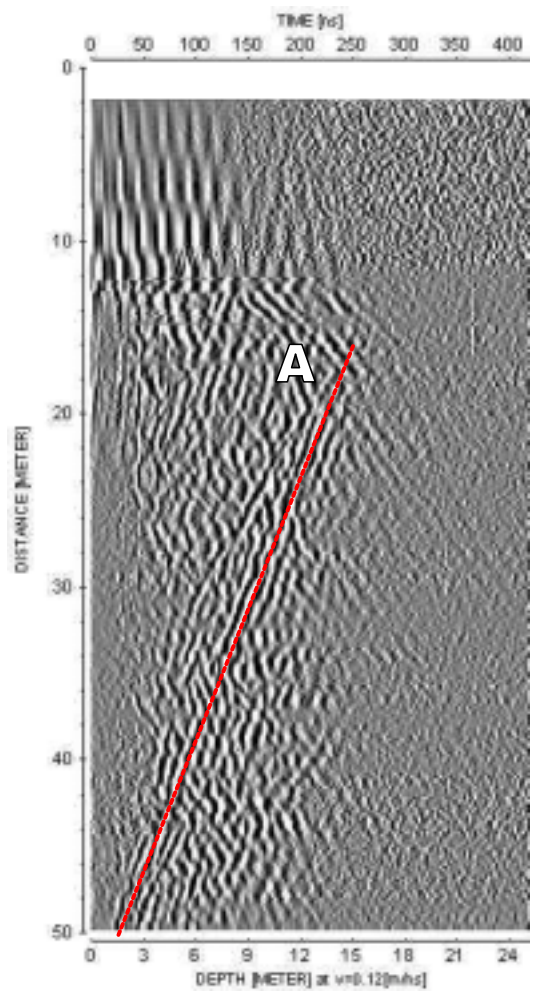

**100 MHz**

SIMPEVARP HSH03

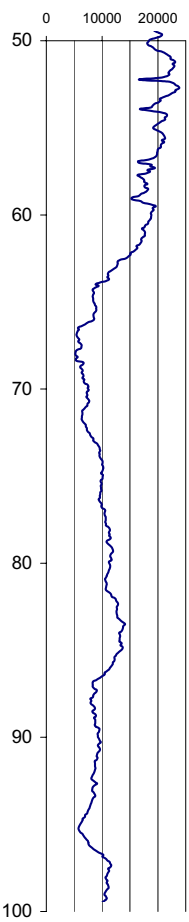

Amplitude of first wave

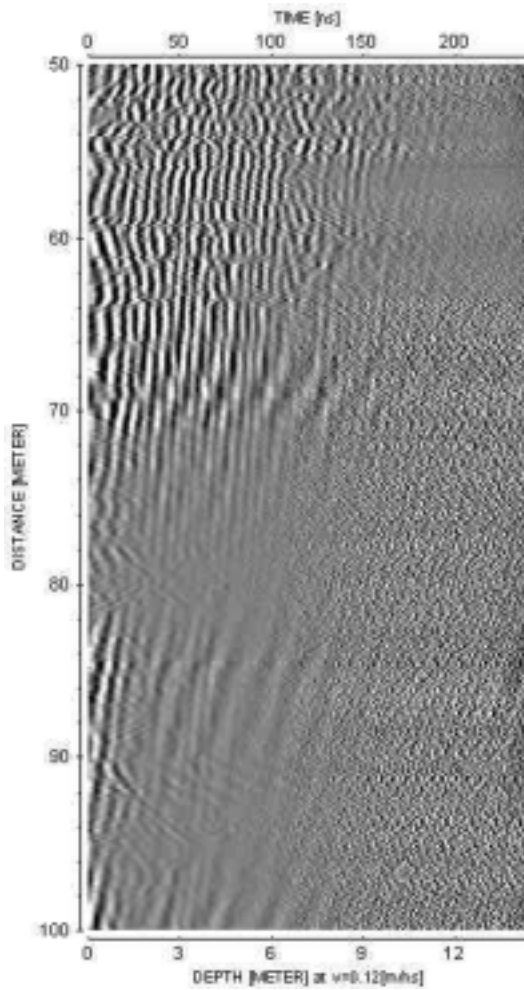

250 MHz

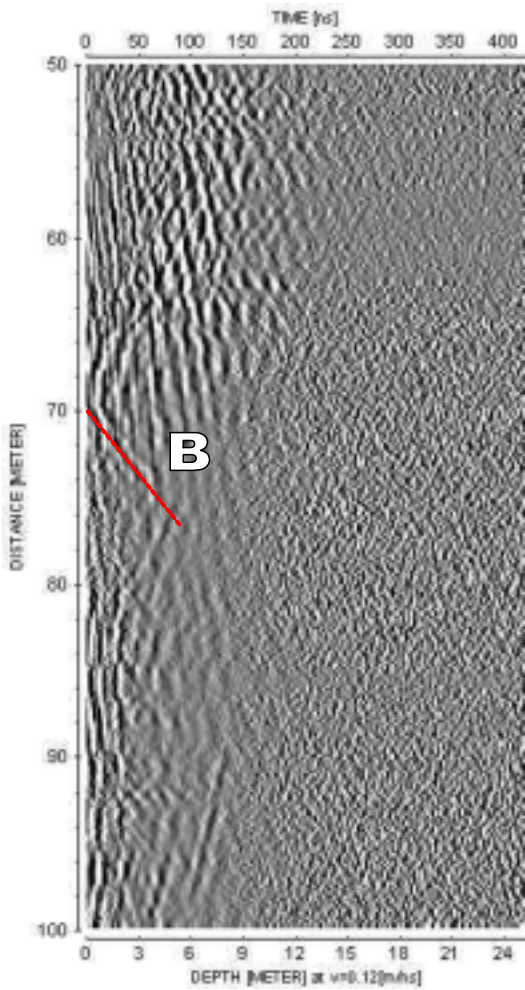

100 MHz

**SIMPEVARP HSH03**

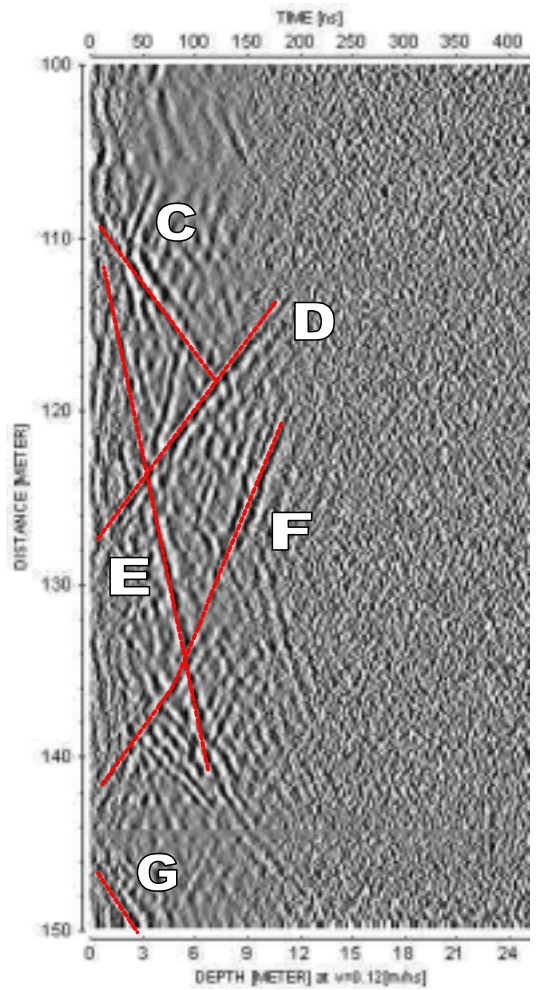
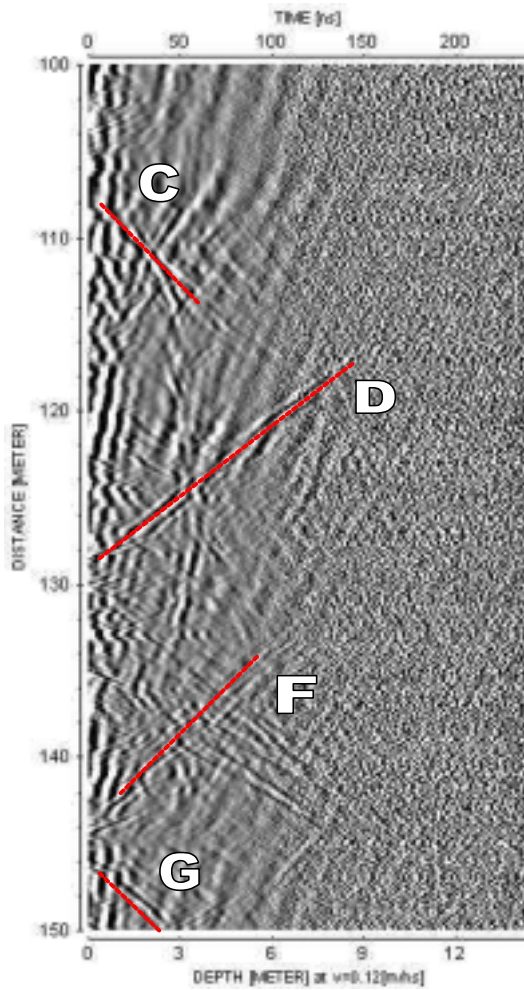
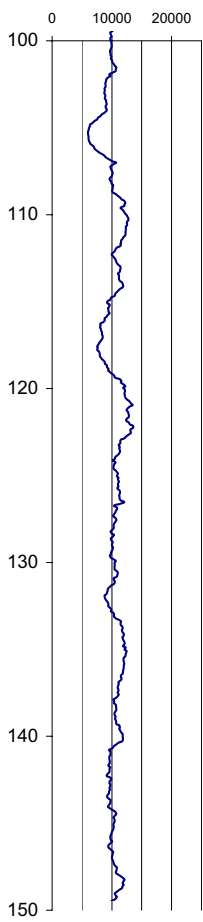

**Amplitude of first wave**

**250 MHz**

**100 MHz**



**SIMPEVARP HSH03**

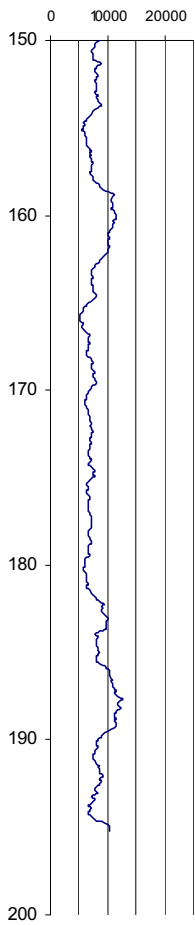

**Amplitude of first wave**

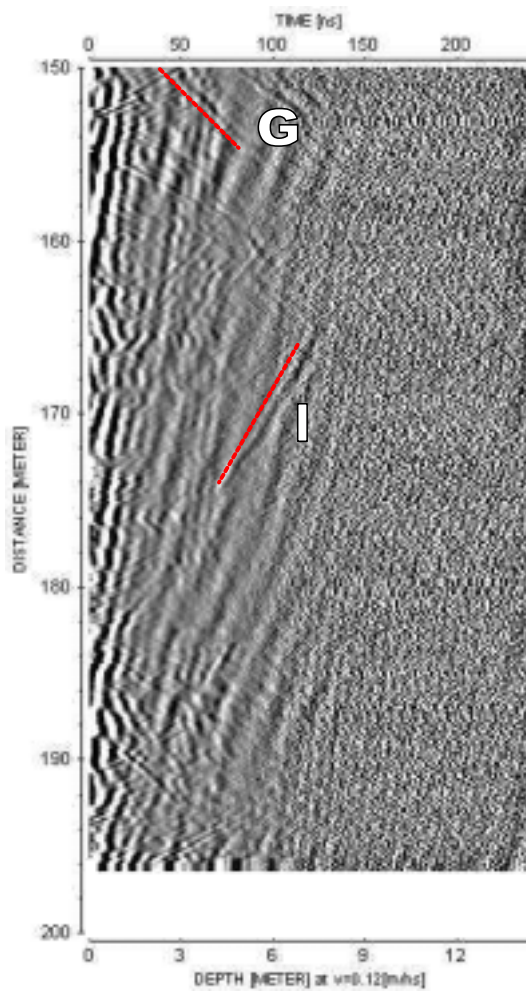

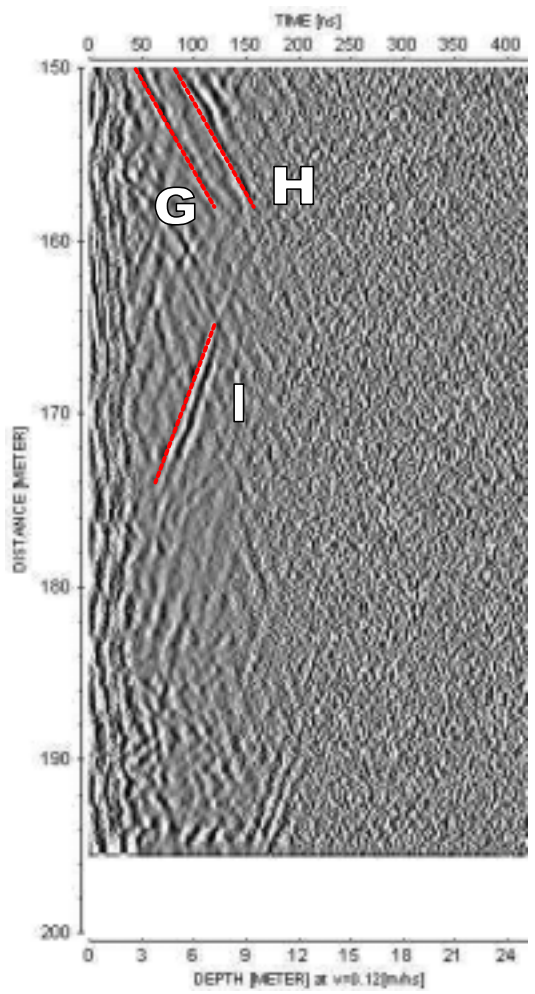

**250 MHz**



**100 MHz**

**BIPS results from the upper part of KSH01A**

**Project name: KSH01A**

**Image file** : c:\gurraw~1\oskars~1\bips\ksh01a\001.bip  
**BDT file** :  
**Locality** : SIMPAN  
**Bore hole number** : KSH01A  
**Date** : 02/09/15  
**Time** : 17:23:00  
**Depth range** : 12.000 - 99.167 m  
**Azimuth** : 0  
**Inclination** : -90  
**Diameter** : 132.0 mm  
**Magnetic declination** : 0.0  
**Span** : 4  
**Scan interval** : 0.25  
**Scan direction** : To bottom  
**Scale** : 1/10  
**Aspect ratio** : 89 %  
**Pages** : 22  
**Color** :  +0  +0  +0



Project name: KSH01A  
Bore hole No.: KSH01A

Azimuth: 0      Inclination: -90

Depth range: 12.000 - 16.000 m

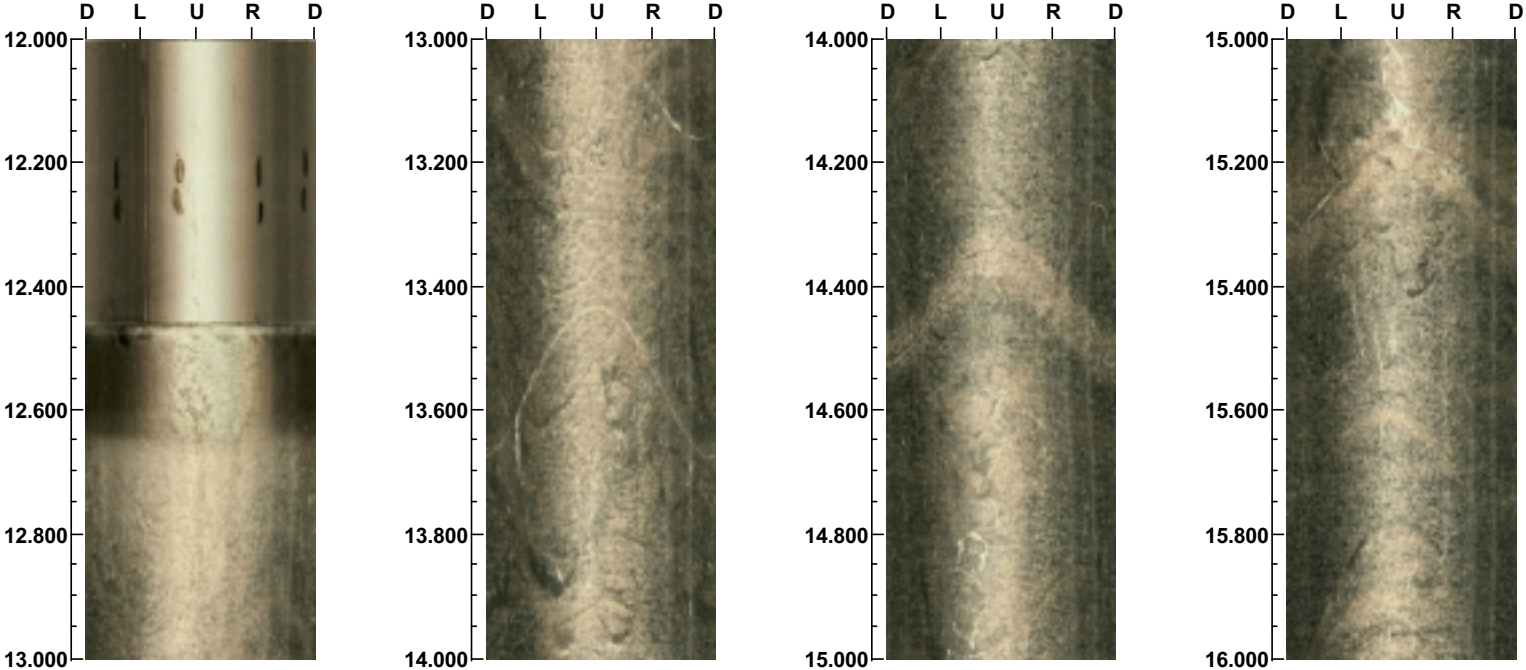

58

Project name: KSH01A  
Bore hole No.: KSH01A

Azimuth: 0      Inclination: -90

Depth range: 16.000 - 20.000 m

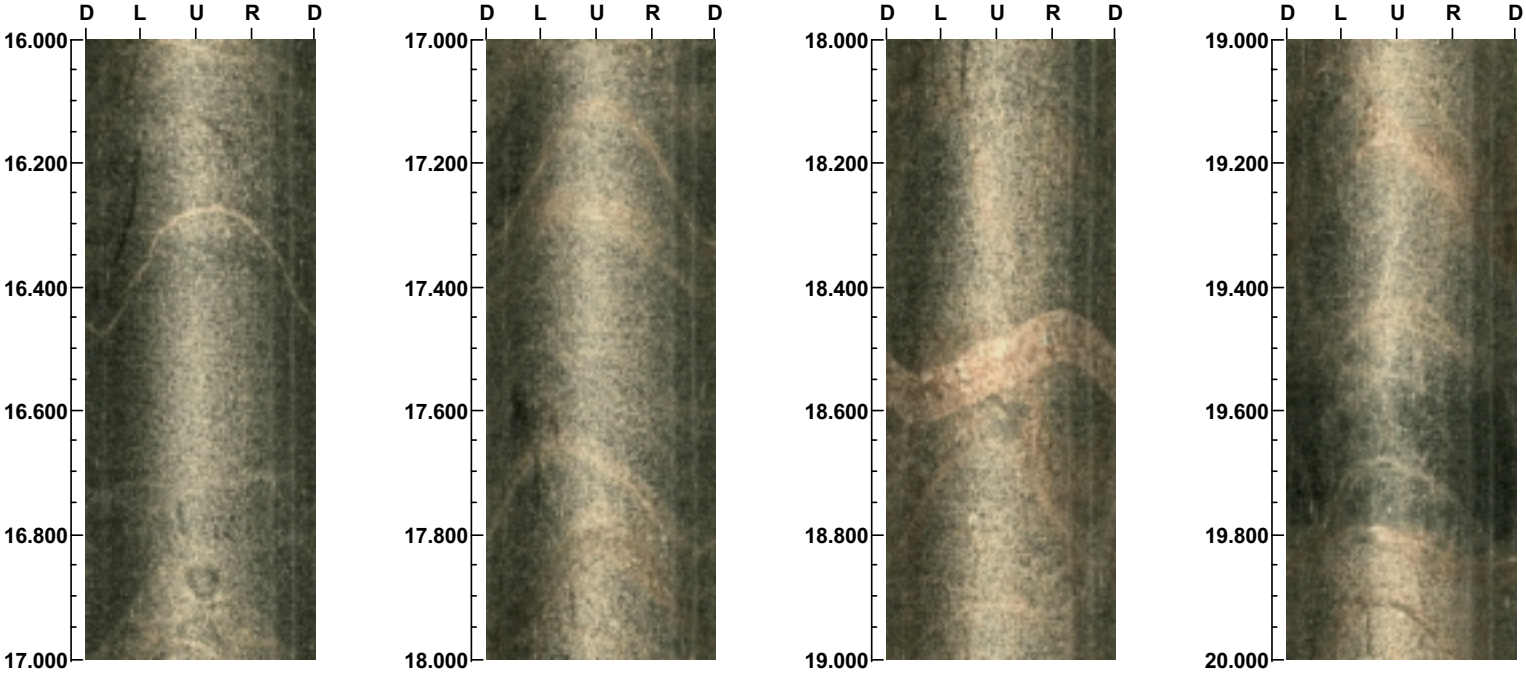

Project name: KSH01A  
Bore hole No.: KSH01A

Azimuth: 0      Inclination: -90

Depth range: 20.000 - 24.000 m

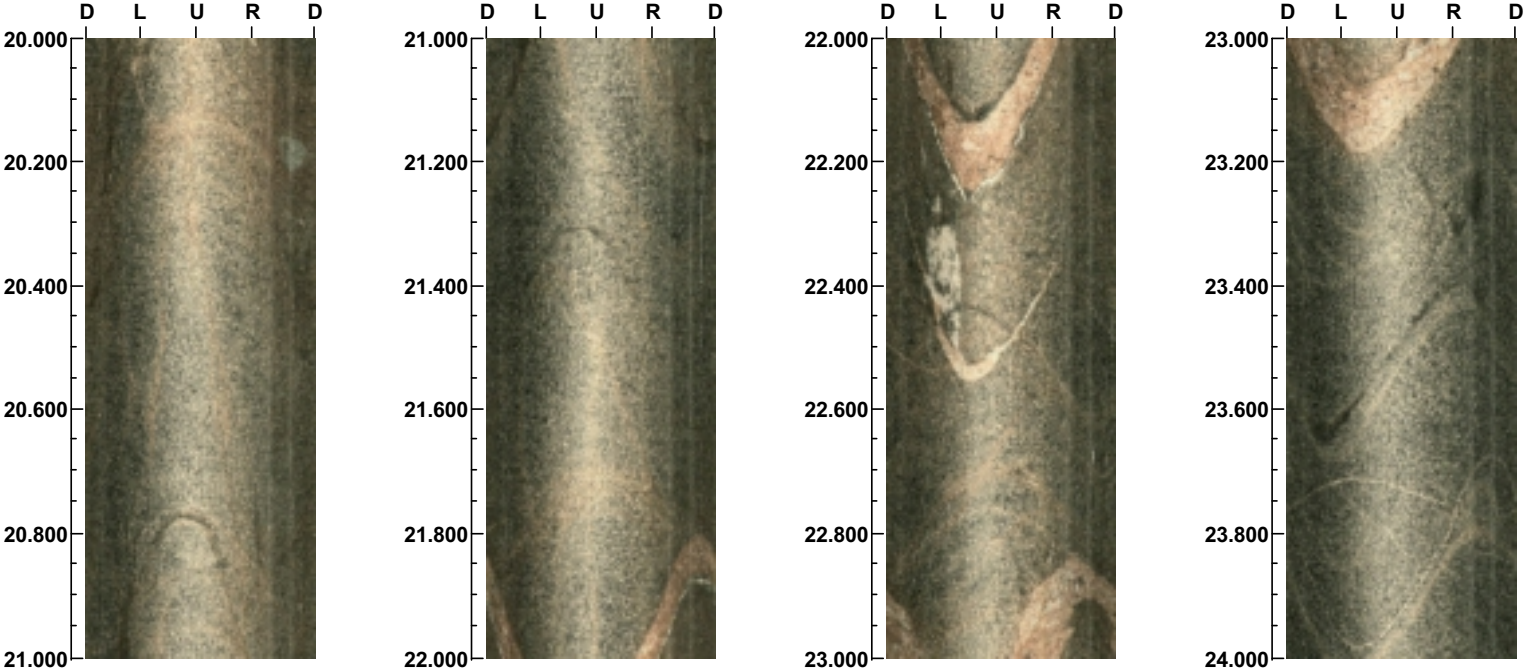

60

Project name: KSH01A  
Bore hole No.: KSH01A

Azimuth: 0      Inclination: -90

Depth range: 24.000 - 28.000 m

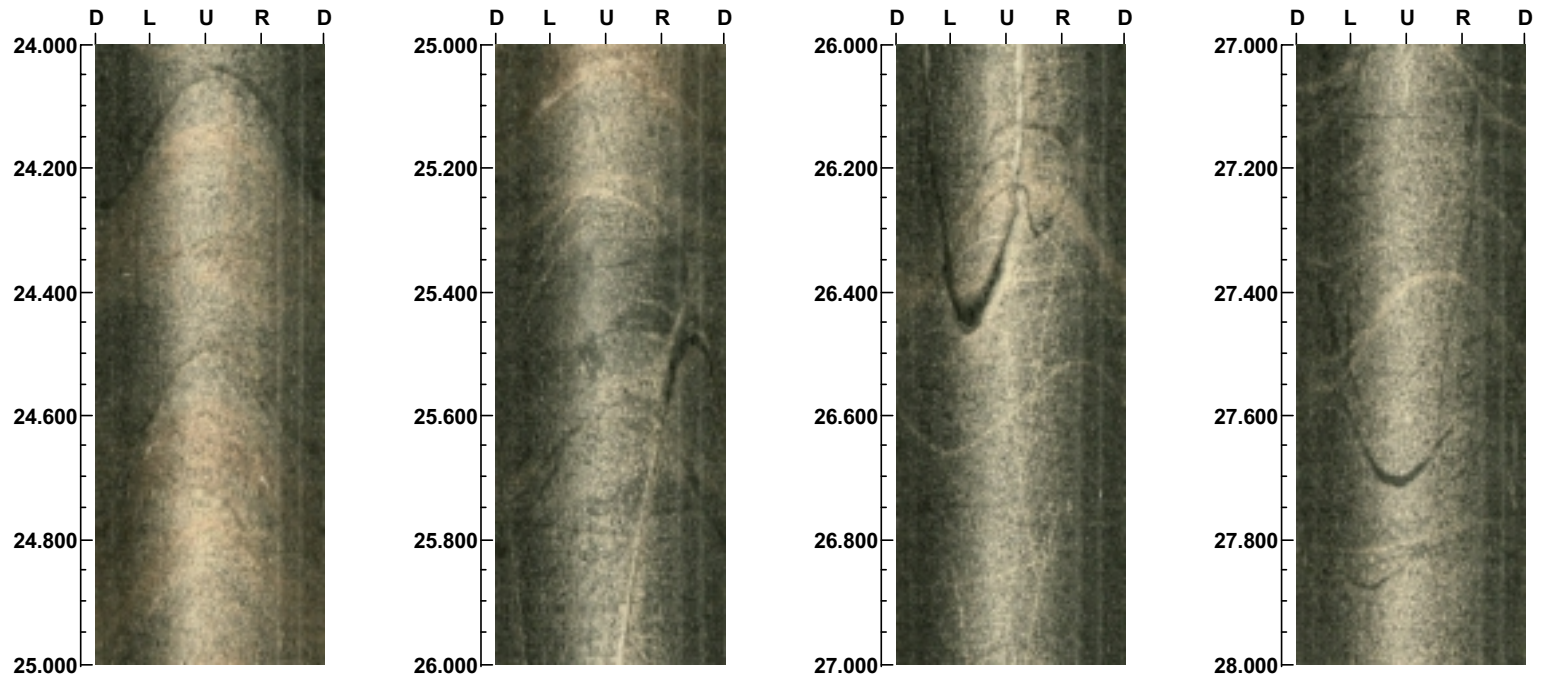

Project name: KSH01A  
Bore hole No.: KSH01A

Azimuth: 0      Inclination: -90

Depth range: 28.000 - 32.000 m

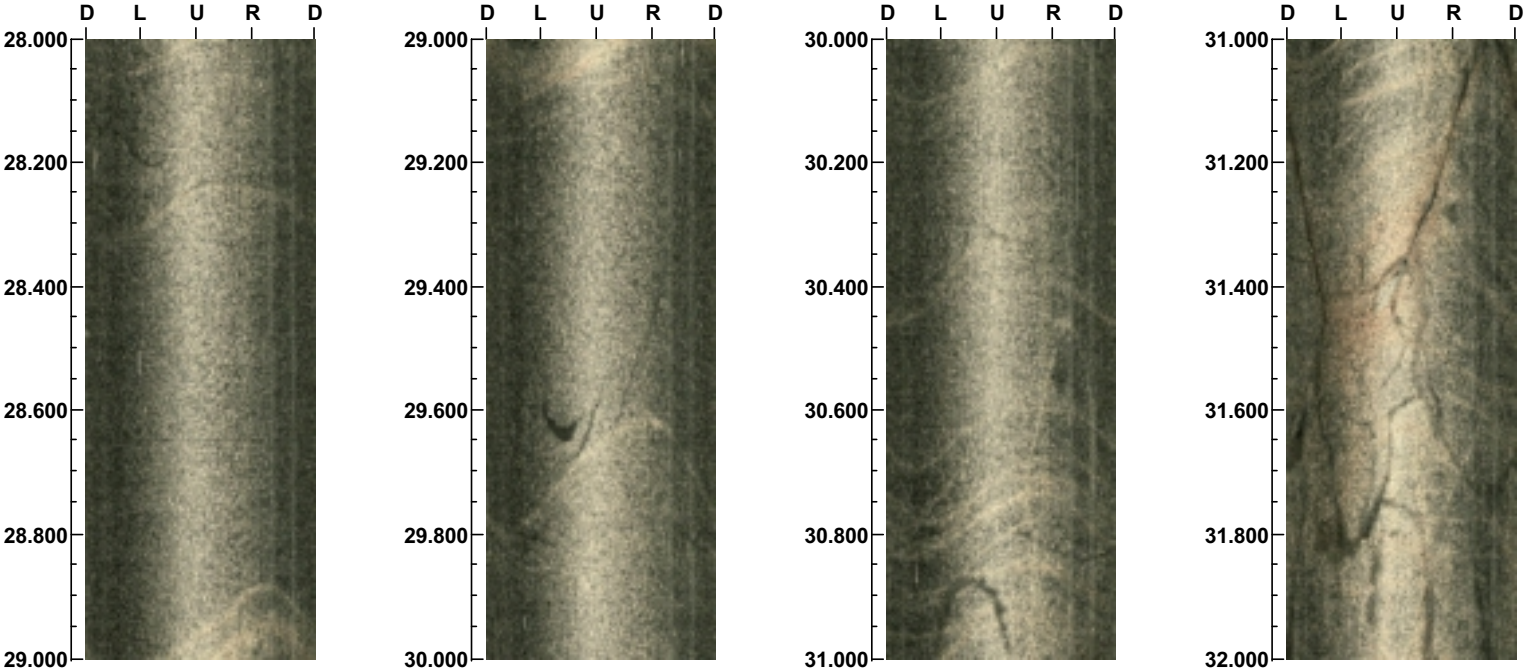



Project name: KSH01A  
Bore hole No.: KSH01A

Azimuth: 0      Inclination: -90

Depth range: 32.000 - 36.000 m

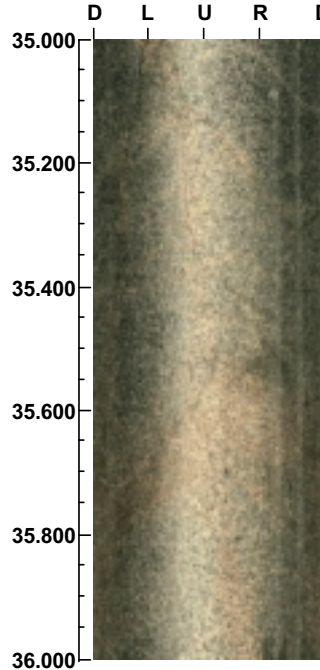
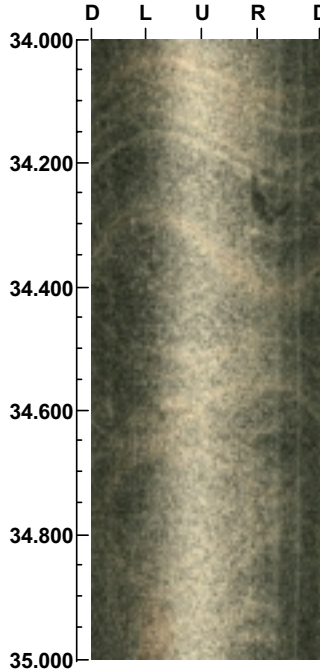
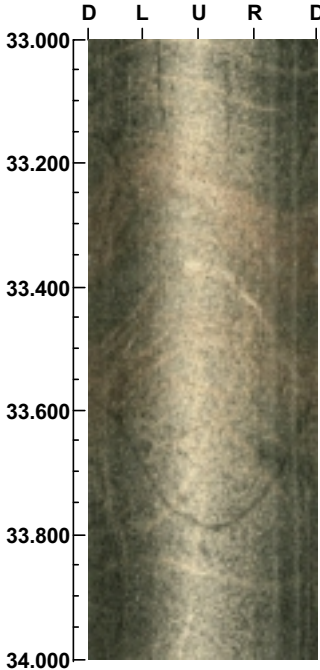
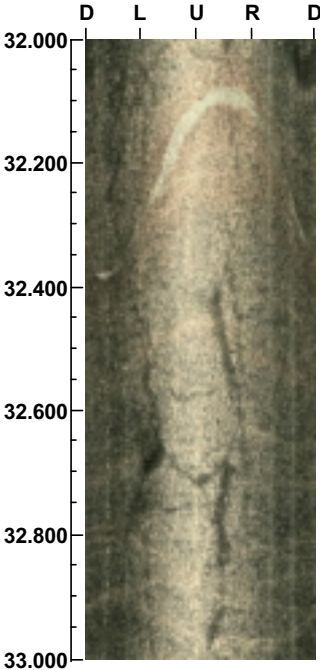

Project name: KSH01A  
Bore hole No.: KSH01A

Azimuth: 0      Inclination: -90

Depth range: 36.000 - 40.000 m

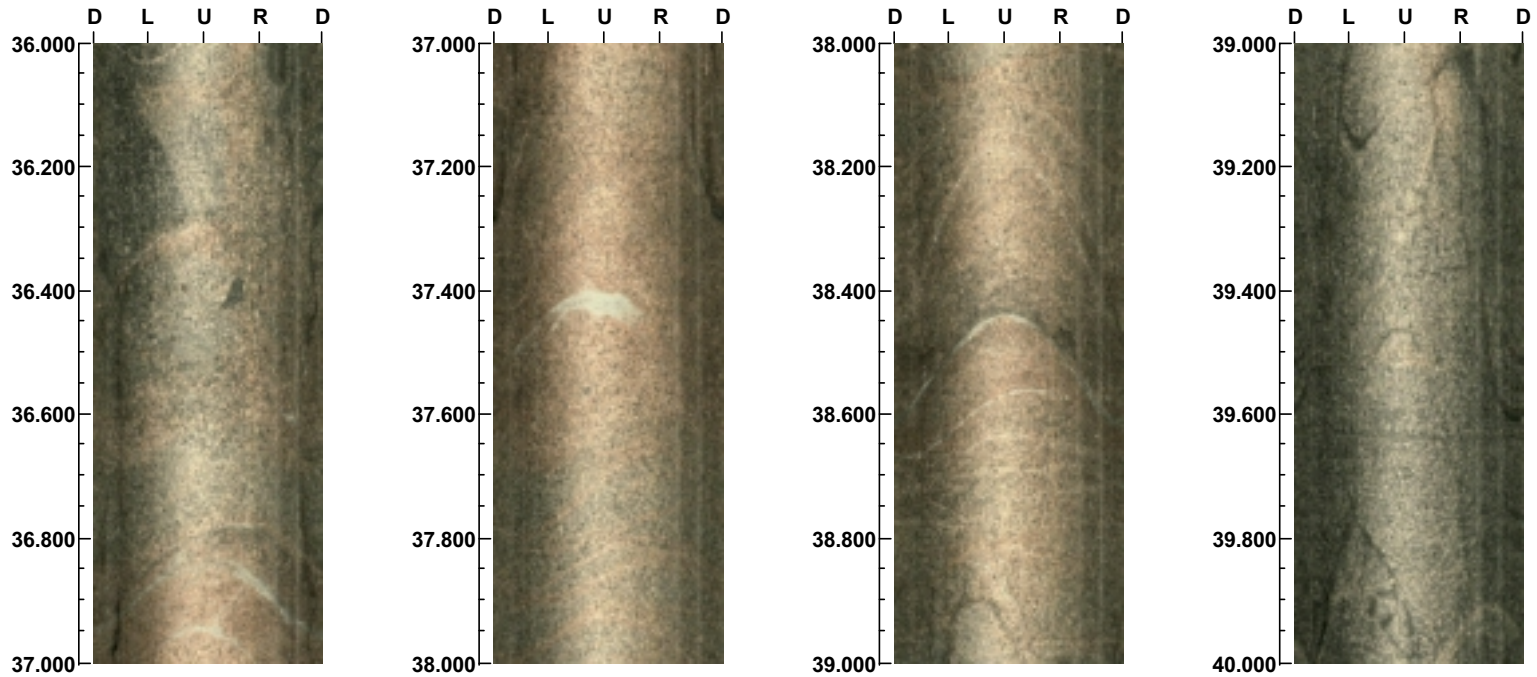

Project name: KSH01A  
Bore hole No.: KSH01A

Azimuth: 0      Inclination: -90

Depth range: 40.000 - 44.000 m

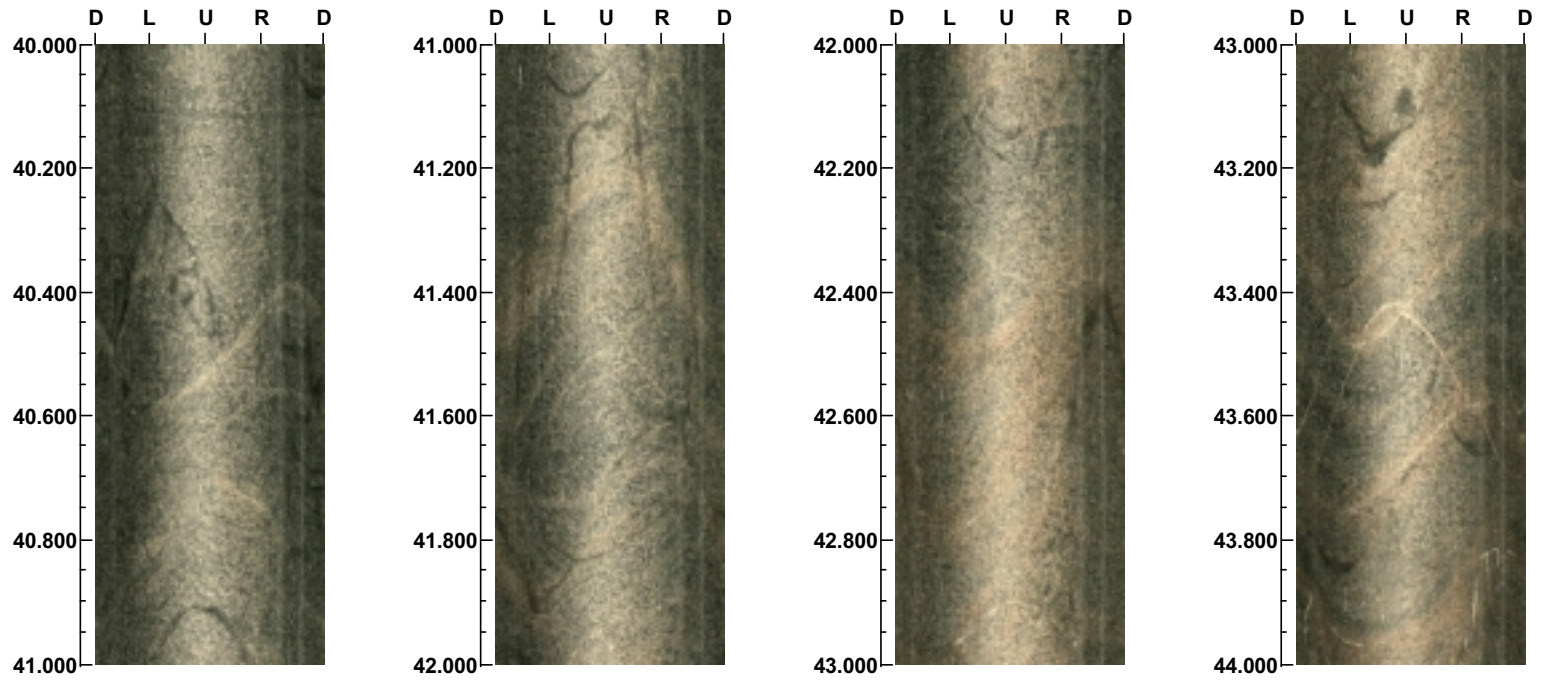

65



Project name: KSH01A  
Bore hole No.: KSH01A

Azimuth: 0      Inclination: -90

Depth range: 44.000 - 48.000 m

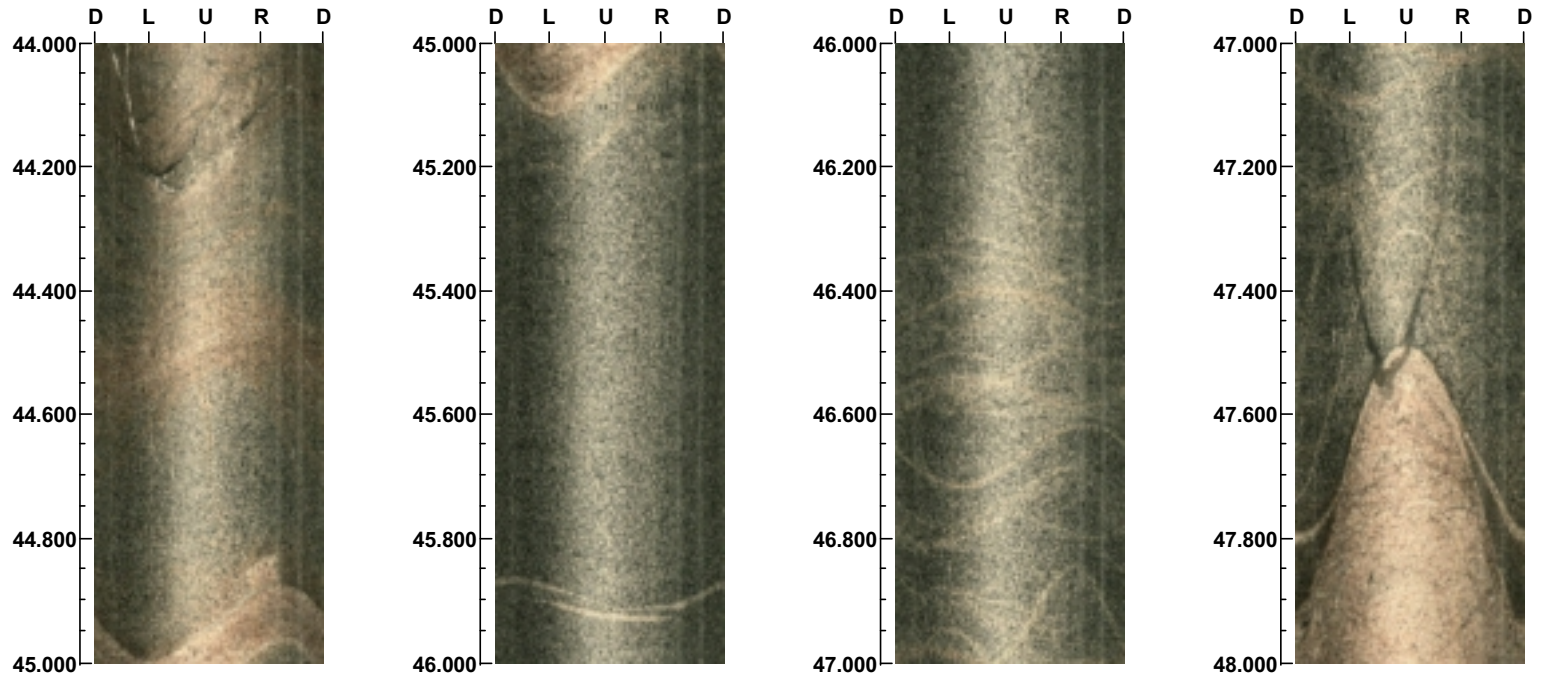

99

( 9 / 22 )

Scale: 1/10      Aspect ratio: 89 %

Project name: KSH01A  
Bore hole No.: KSH01A

Azimuth: 0      Inclination: -90

Depth range: 48.000 - 52.000 m

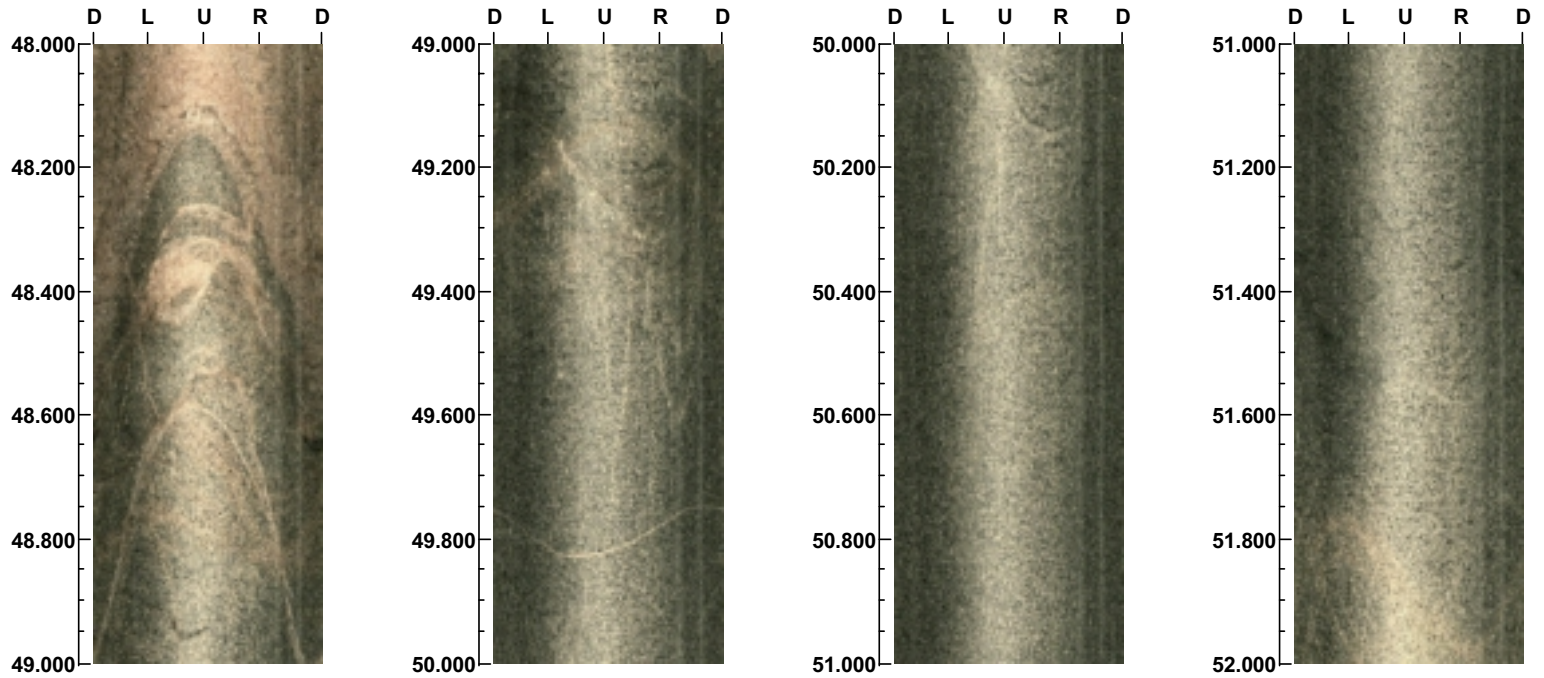

Project name: KSH01A  
Bore hole No.: KSH01A

Azimuth: 0      Inclination: -90

Depth range: 52.000 - 56.000 m

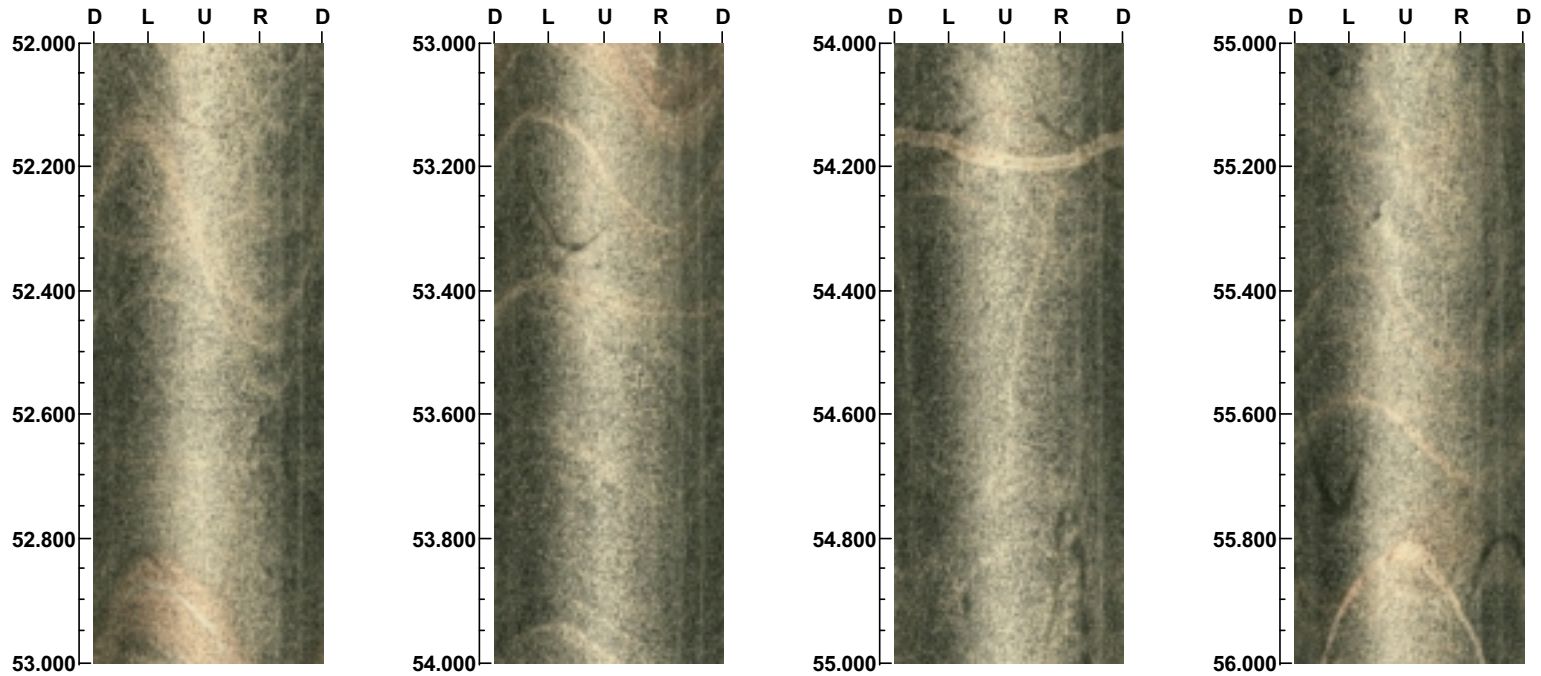

88

( 11 / 22 )

Scale: 1/10      Aspect ratio: 89 %

Project name: KSH01A  
Bore hole No.: KSH01A

Azimuth: 0      Inclination: -90

Depth range: 56.000 - 60.000 m

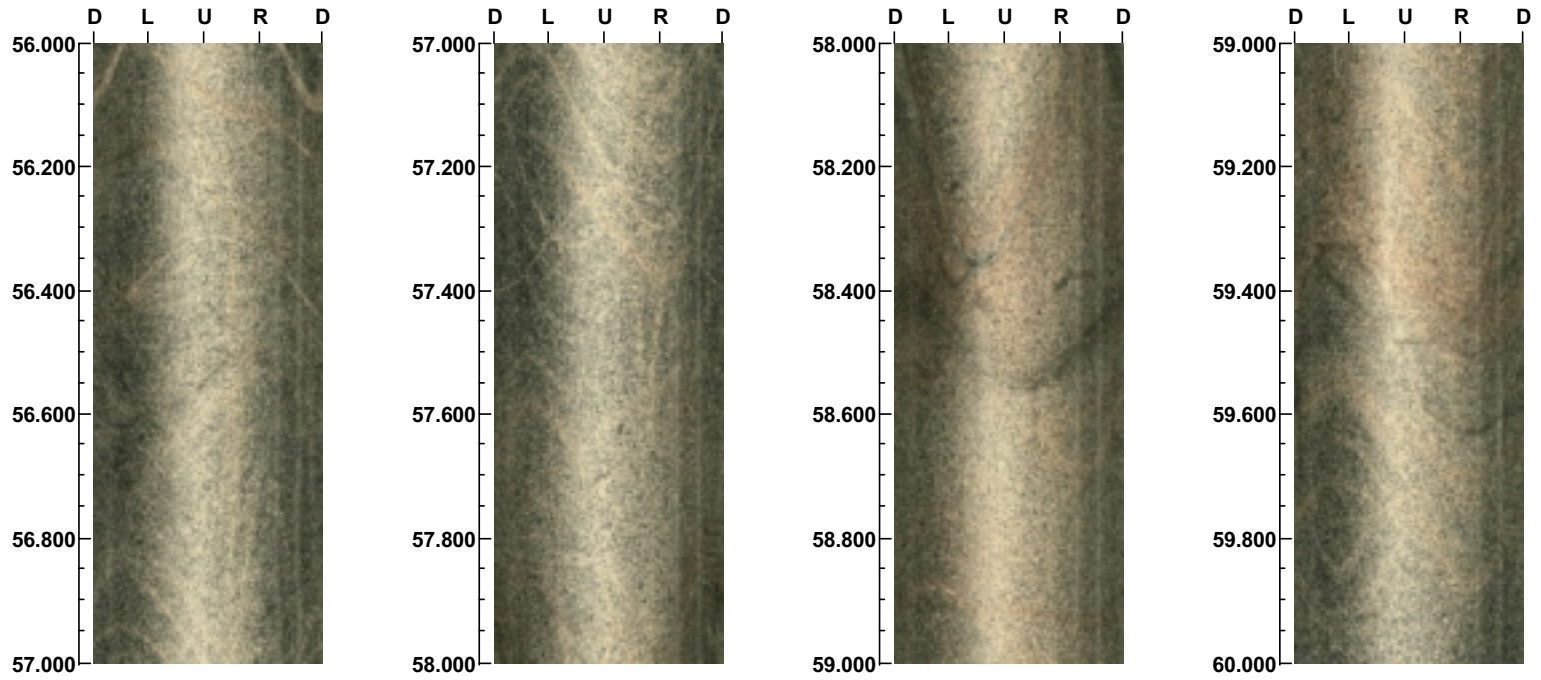

Project name: KSH01A  
Bore hole No.: KSH01A

Azimuth: 0      Inclination: -90

Depth range: 60.000 - 64.000 m

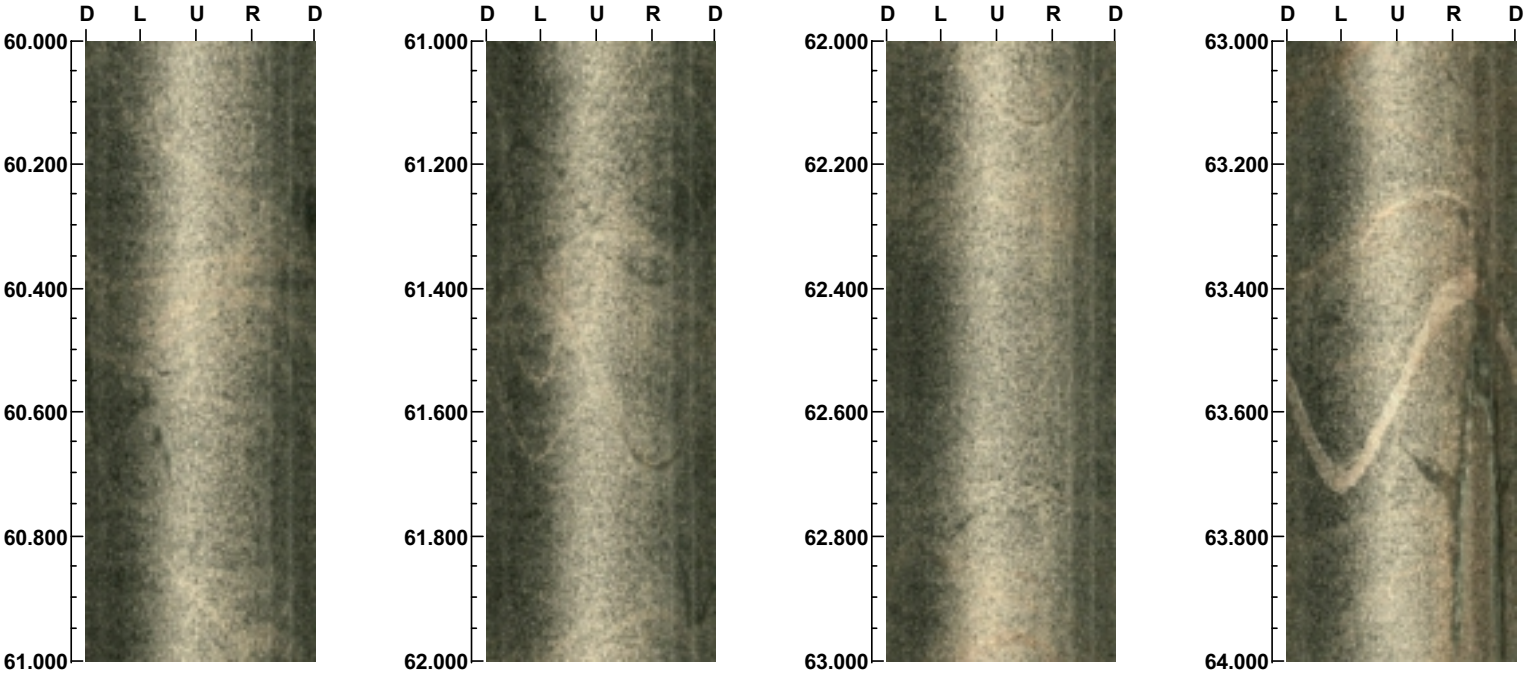

70



Project name: KSH01A  
Bore hole No.: KSH01A

Azimuth: 0      Inclination: -90

Depth range: 64.000 - 68.000 m

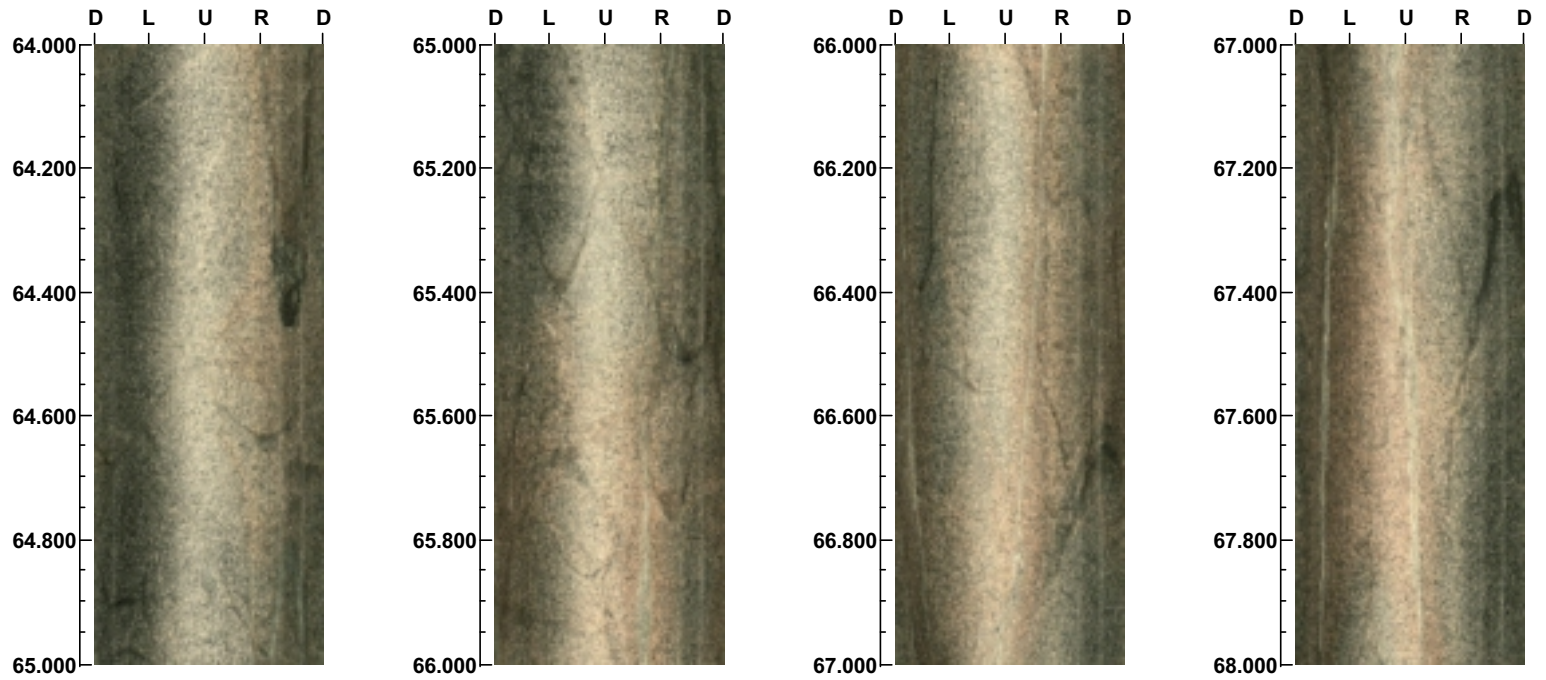

Project name: KSH01A  
Bore hole No.: KSH01A

Azimuth: 0      Inclination: -90

Depth range: 68.000 - 72.000 m

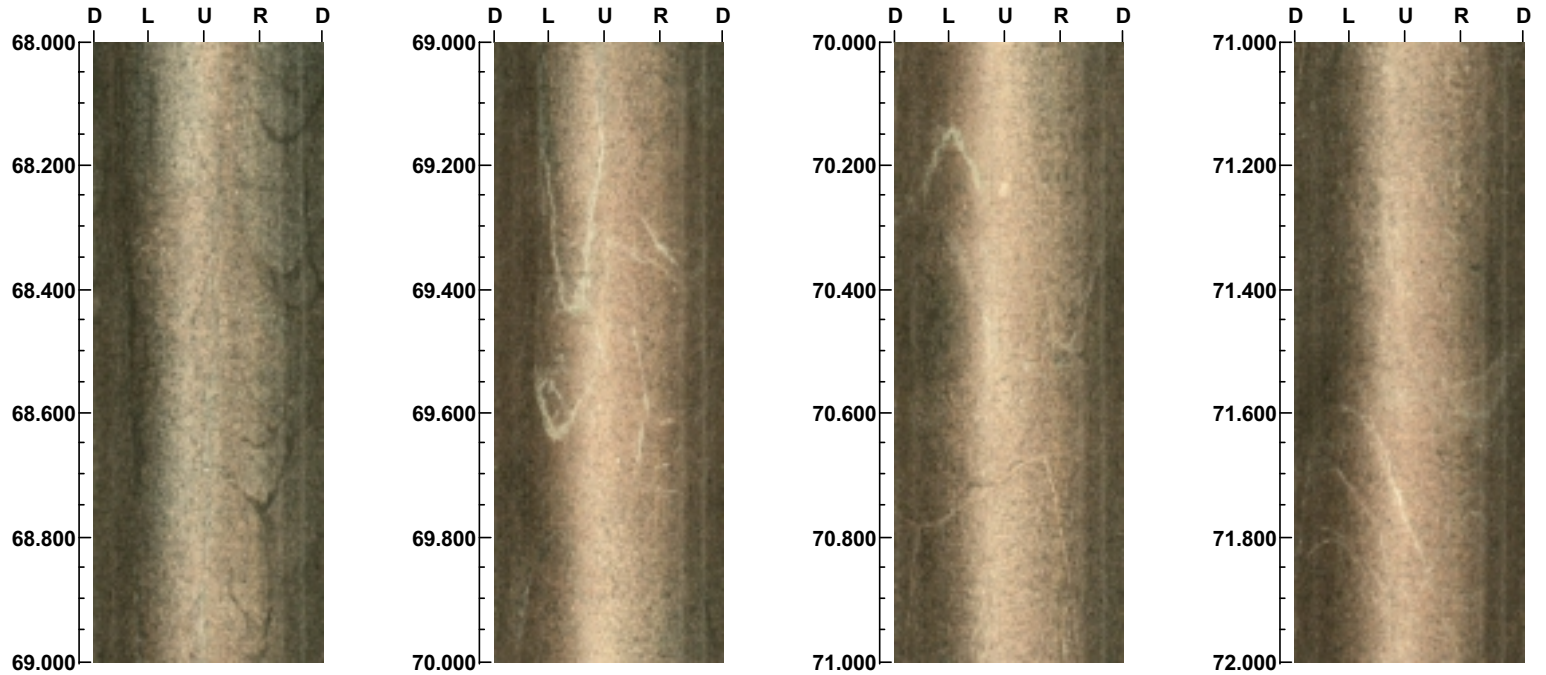

72

( 15 / 22 )

Scale: 1/10      Aspect ratio: 89 %

Project name: KSH01A  
Bore hole No.: KSH01A

Azimuth: 0      Inclination: -90

Depth range: 72.000 - 76.000 m

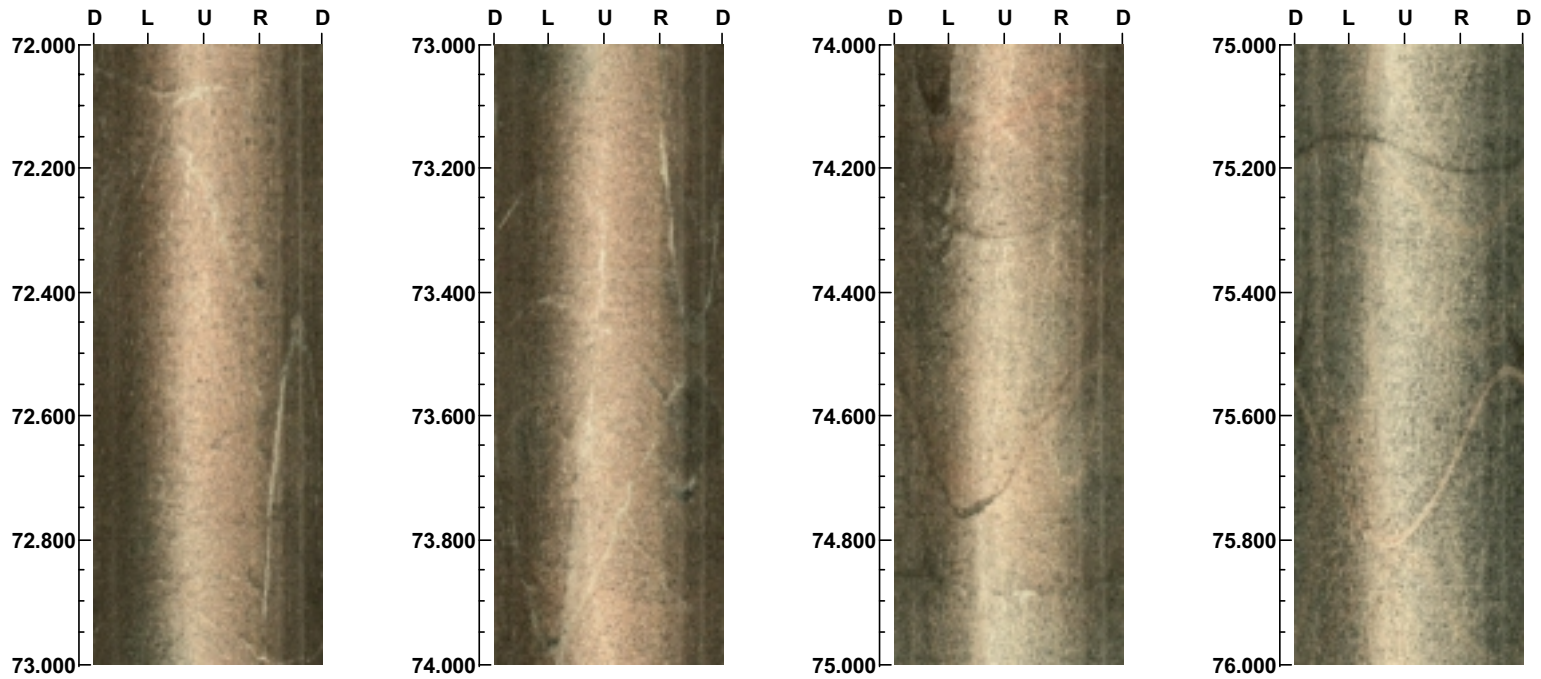

73



Project name: KSH01A  
Bore hole No.: KSH01A

Azimuth: 0      Inclination: -90

Depth range: 76.000 - 80.000 m

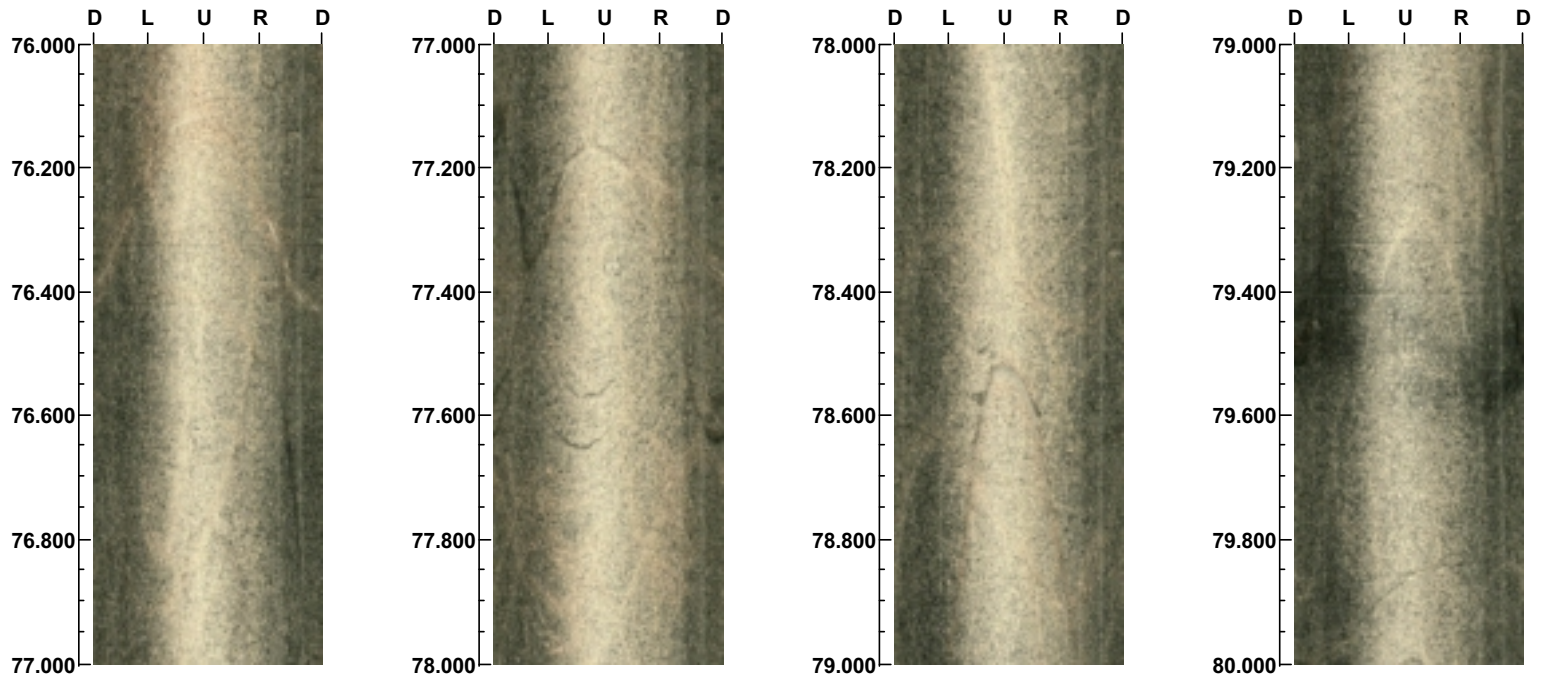

Project name: KSH01A  
Bore hole No.: KSH01A

Azimuth: 0      Inclination: -90

Depth range: 80.000 - 84.000 m

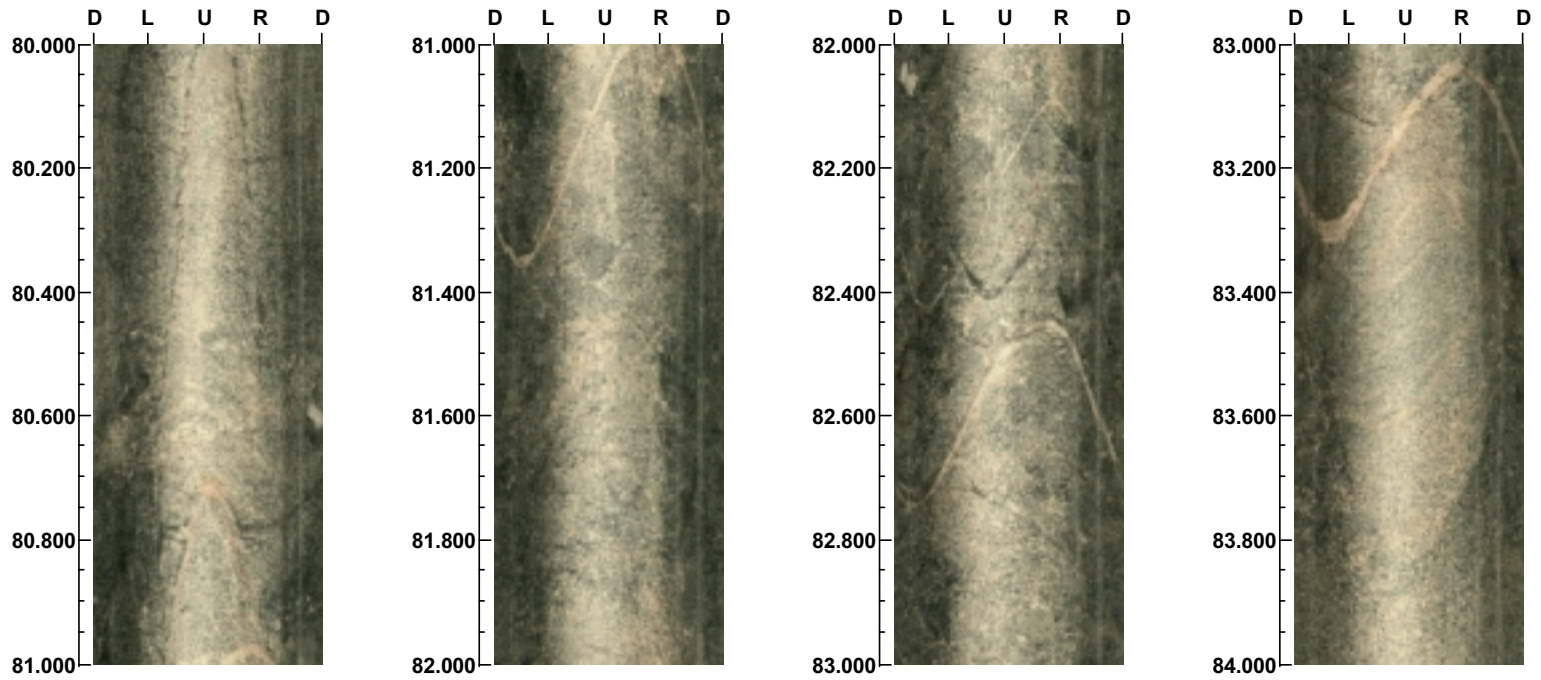

75

Project name: KSH01A  
Bore hole No.: KSH01A

Azimuth: 0      Inclination: -90

Depth range: 84.000 - 88.000 m

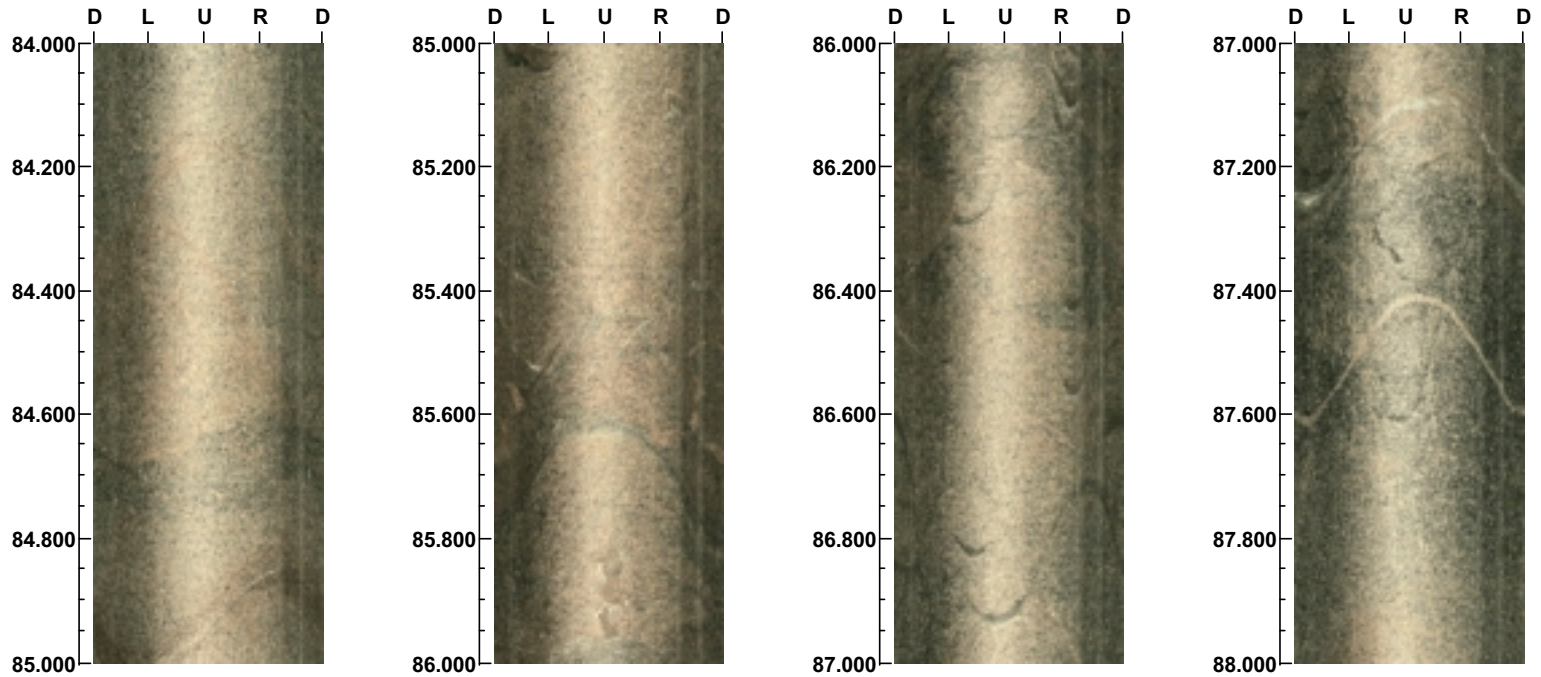

Project name: KSH01A  
Bore hole No.: KSH01A

Azimuth: 0      Inclination: -90

Depth range: 88.000 - 92.000 m

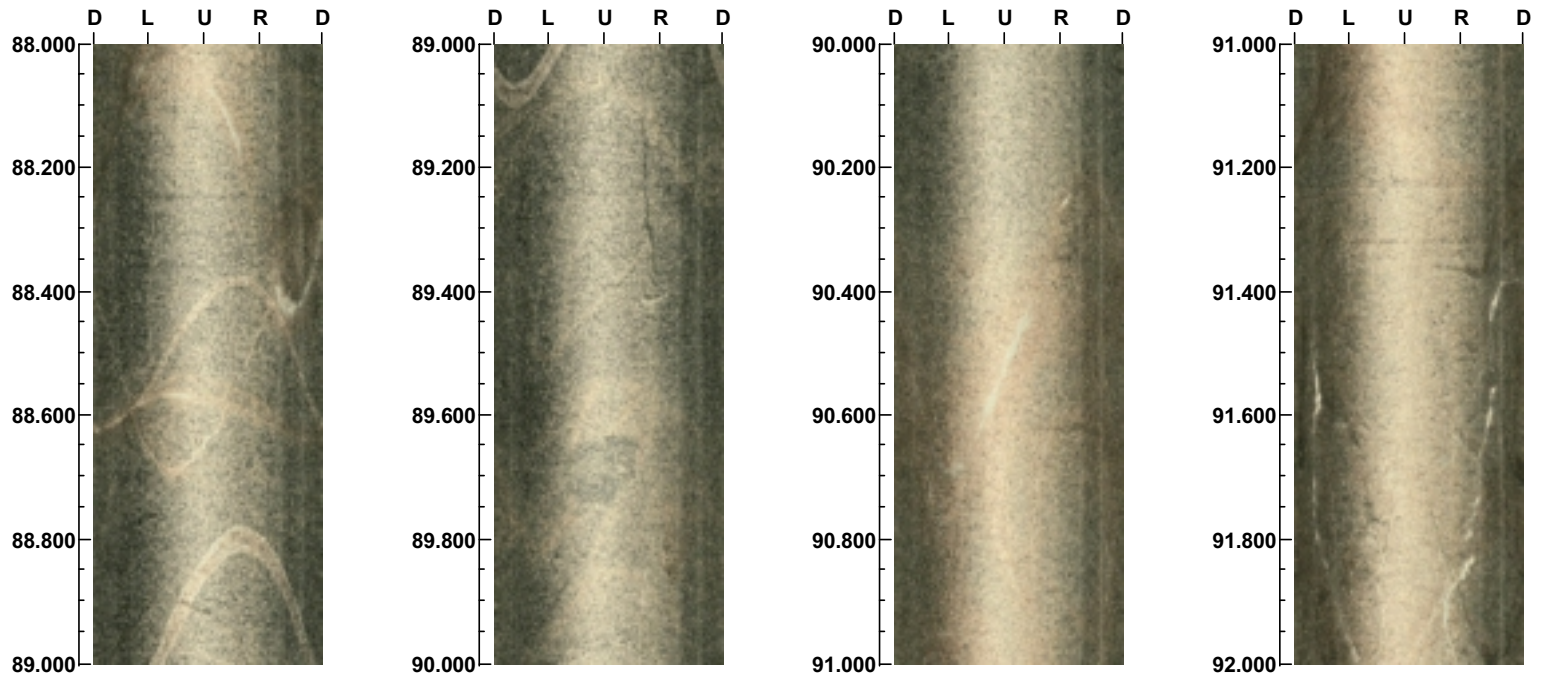

77

Project name: KSH01A  
Bore hole No.: KSH01A

Azimuth: 0      Inclination: -90

Depth range: 92.000 - 96.000 m

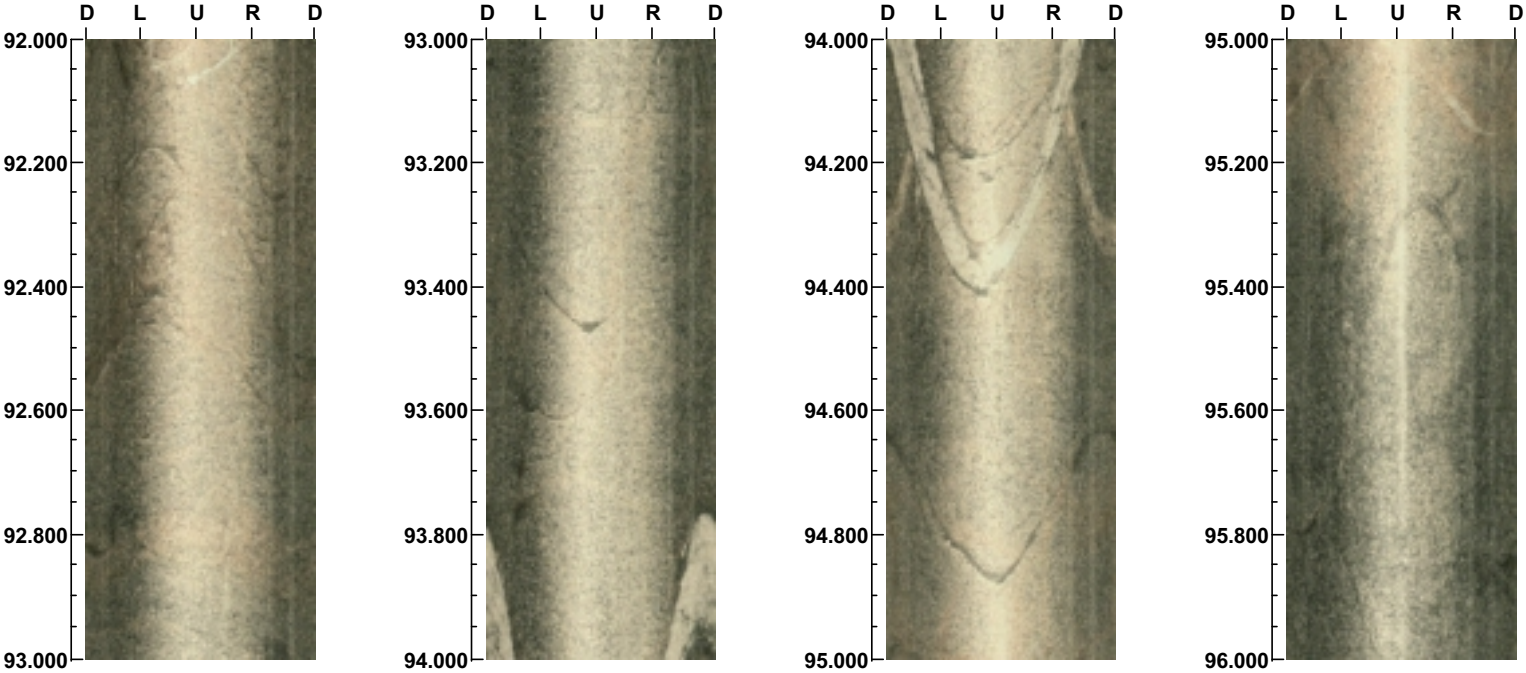

78



Project name: KSH01A  
Bore hole No.: KSH01A

Azimuth: 0      Inclination: -90

Depth range: 96.000 - 99.167 m

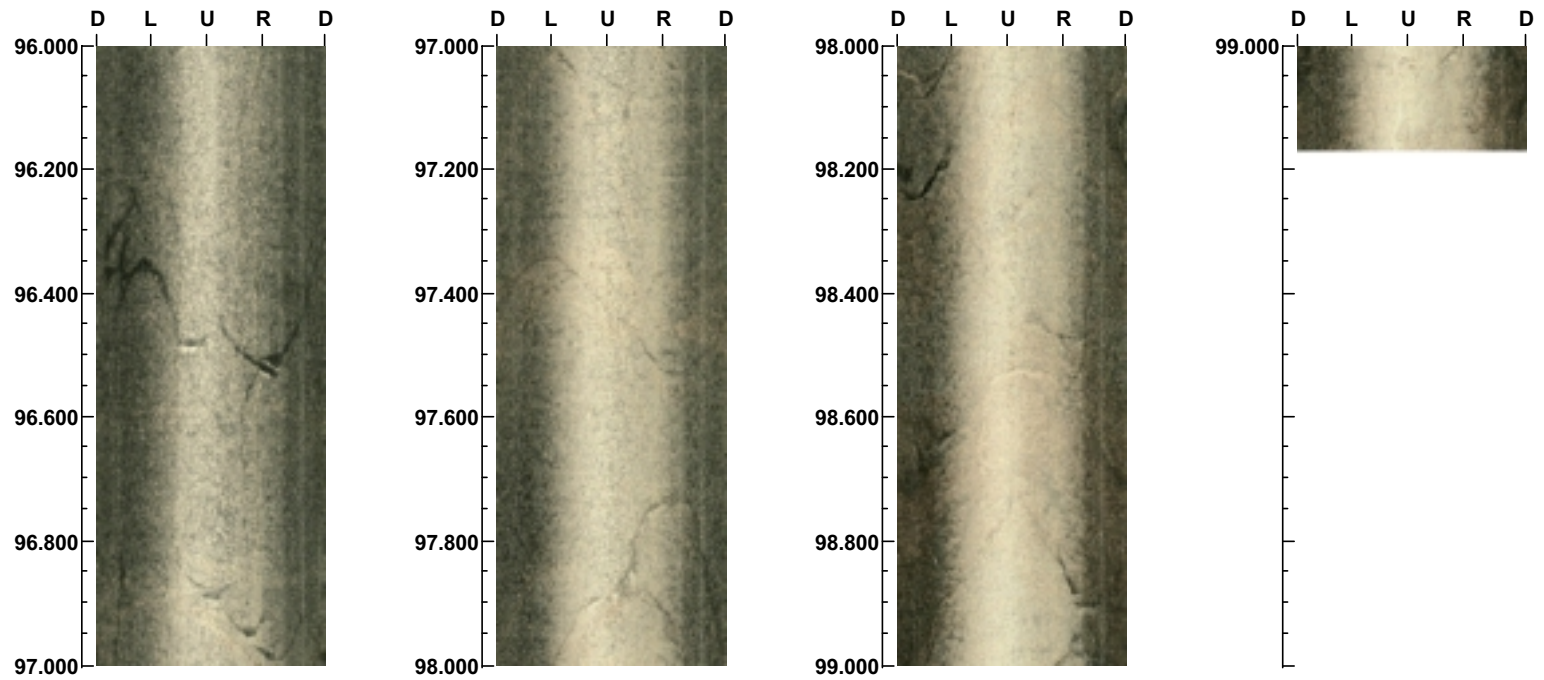

79

**BIPS results from HSH01**

**Project name: HSH01**

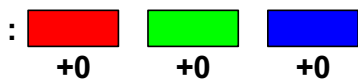
**Image file** : c:\gurraw~1\oskars~1\bips\hsh01\000.bip  
**BDT file** :  
**Locality** : SIMPAN  
**Bore hole number** : HSH01  
**Date** : 02/09/16  
**Time** : 13:15:00  
**Depth range** : 11.000 - 132.000 m  
**Azimuth** : 0  
**Inclination** : -90  
**Diameter** : 132.0 mm  
**Magnetic declination** : 0.0  
**Span** : 4  
**Scan interval** : 0.25  
**Scan direction** : To bottom  
**Scale** : 1/10  
**Aspect ratio** : 89 %  
**Pages** : 31  
**Color** : 

Project name: HSH01  
Bore hole No.: HSH01

Azimuth: 0      Inclination: -90

Depth range: 11.000 - 15.000 m

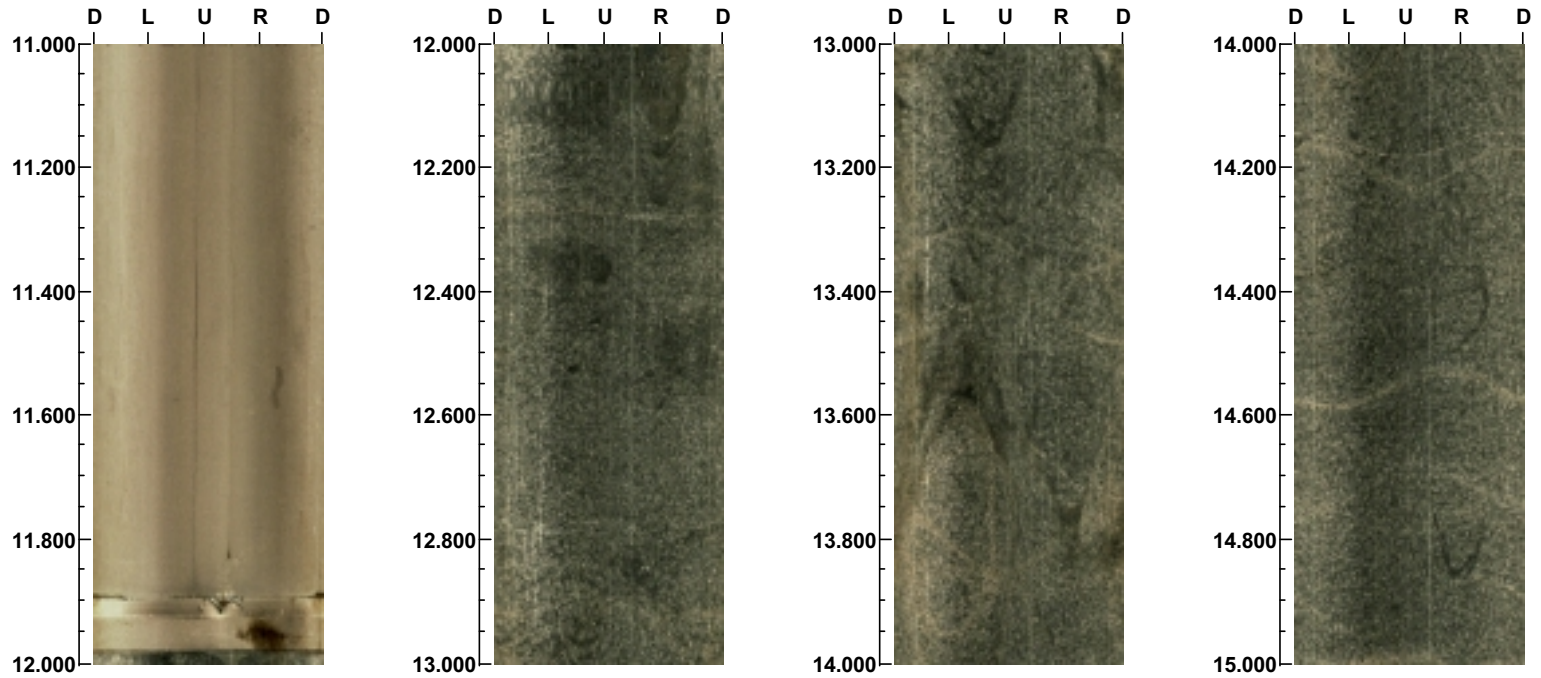



Project name: HSH01  
Bore hole No.: HSH01

Azimuth: 0      Inclination: -90

Depth range: 15.000 - 19.000 m

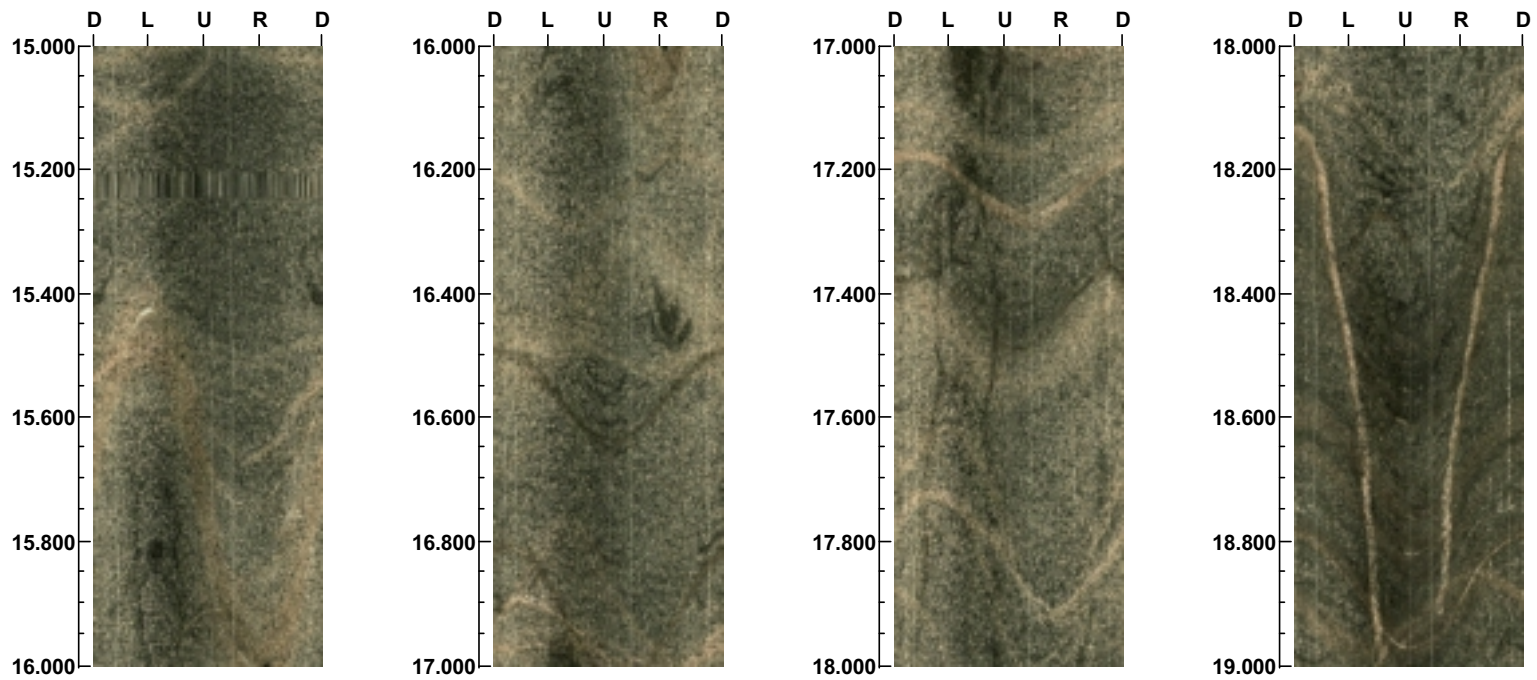

83

Project name: HSH01  
Bore hole No.: HSH01

Azimuth: 0      Inclination: -90

Depth range: 19.000 - 23.000 m

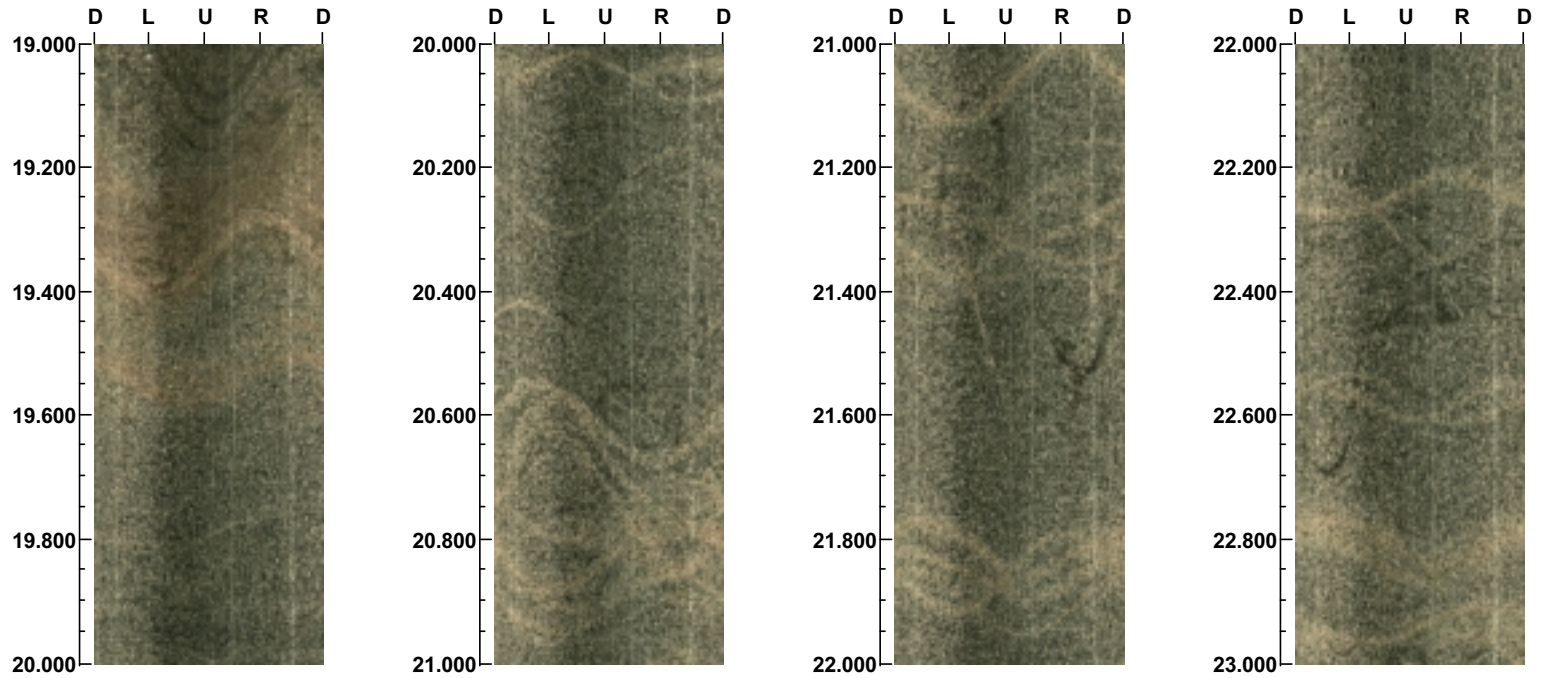

Project name: HSH01  
Bore hole No.: HSH01

Azimuth: 0      Inclination: -90

Depth range: 23.000 - 27.000 m

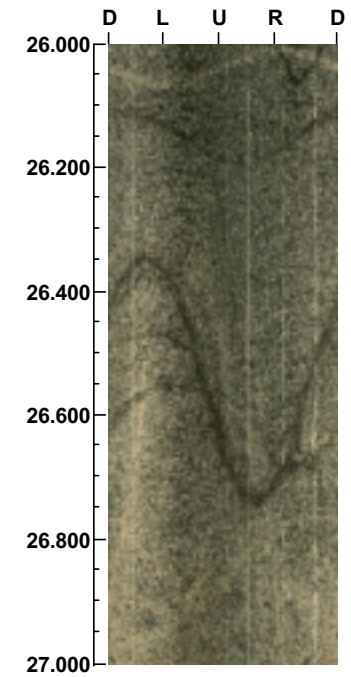
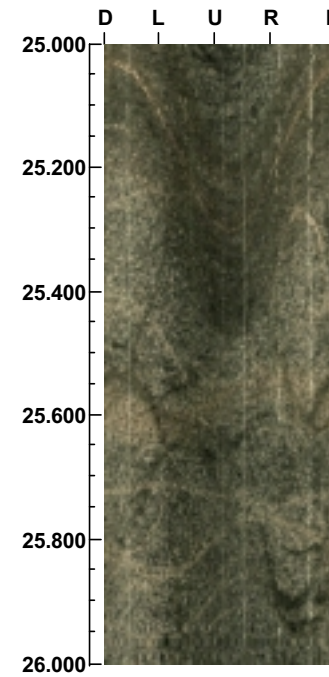
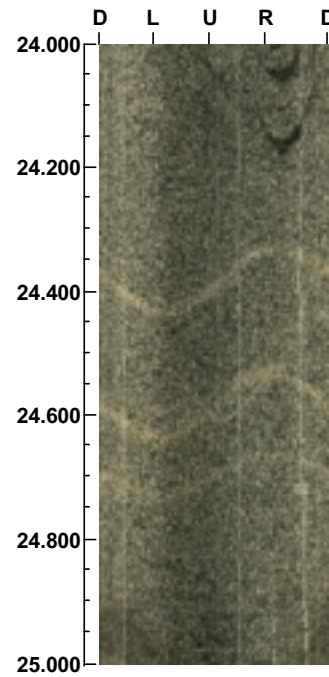
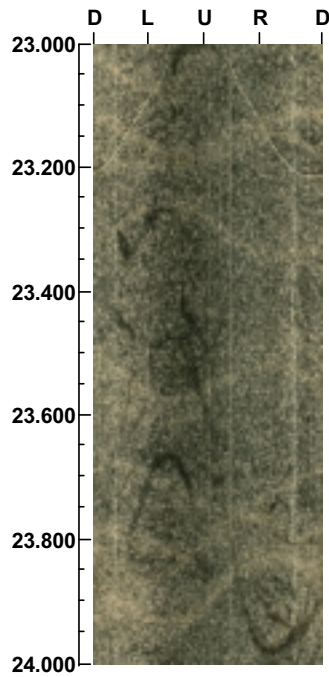

85

Project name: HSH01  
Bore hole No.: HSH01

Azimuth: 0      Inclination: -90

Depth range: 27.000 - 31.000 m

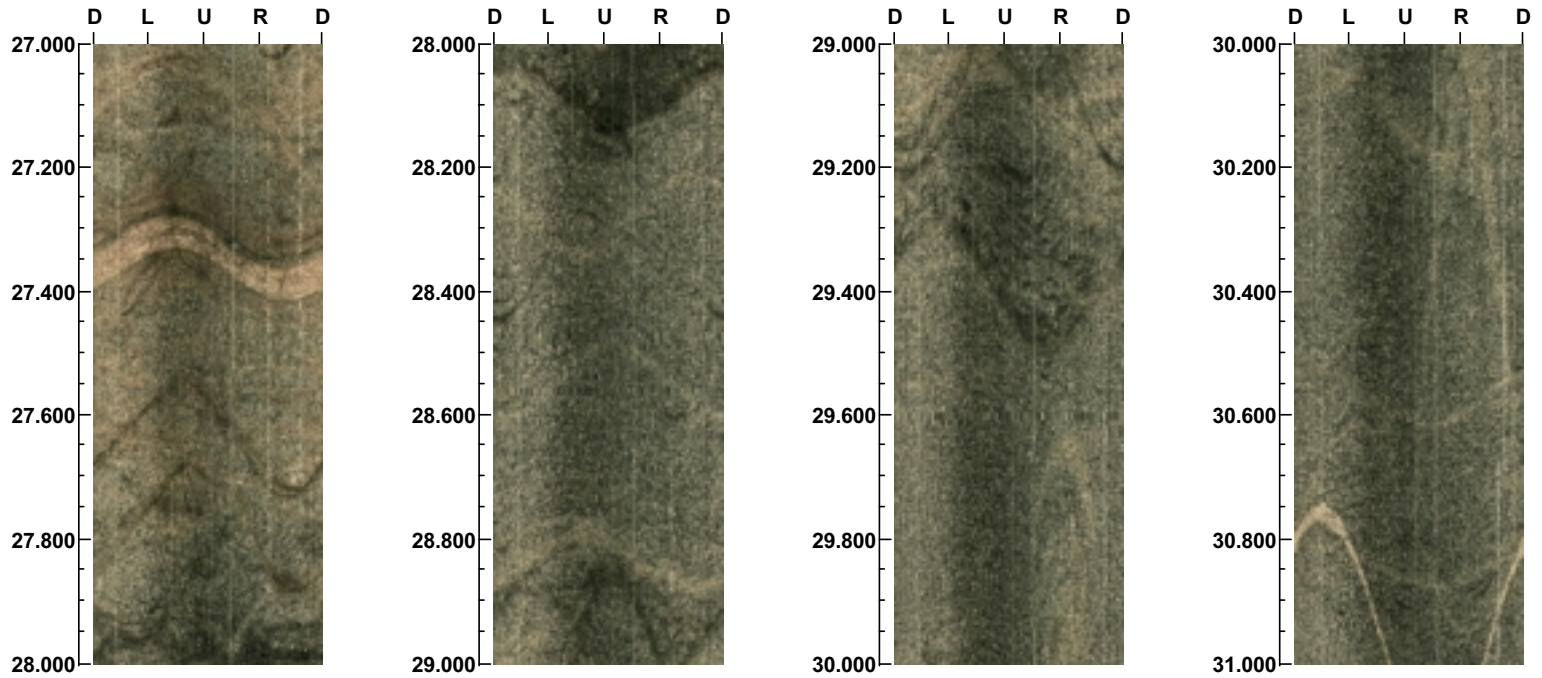

86

( 5 / 31 )

Scale: 1/10      Aspect ratio: 89 %

Project name: HSH01  
Bore hole No.: HSH01

Azimuth: 0      Inclination: -90

Depth range: 31.000 - 35.000 m

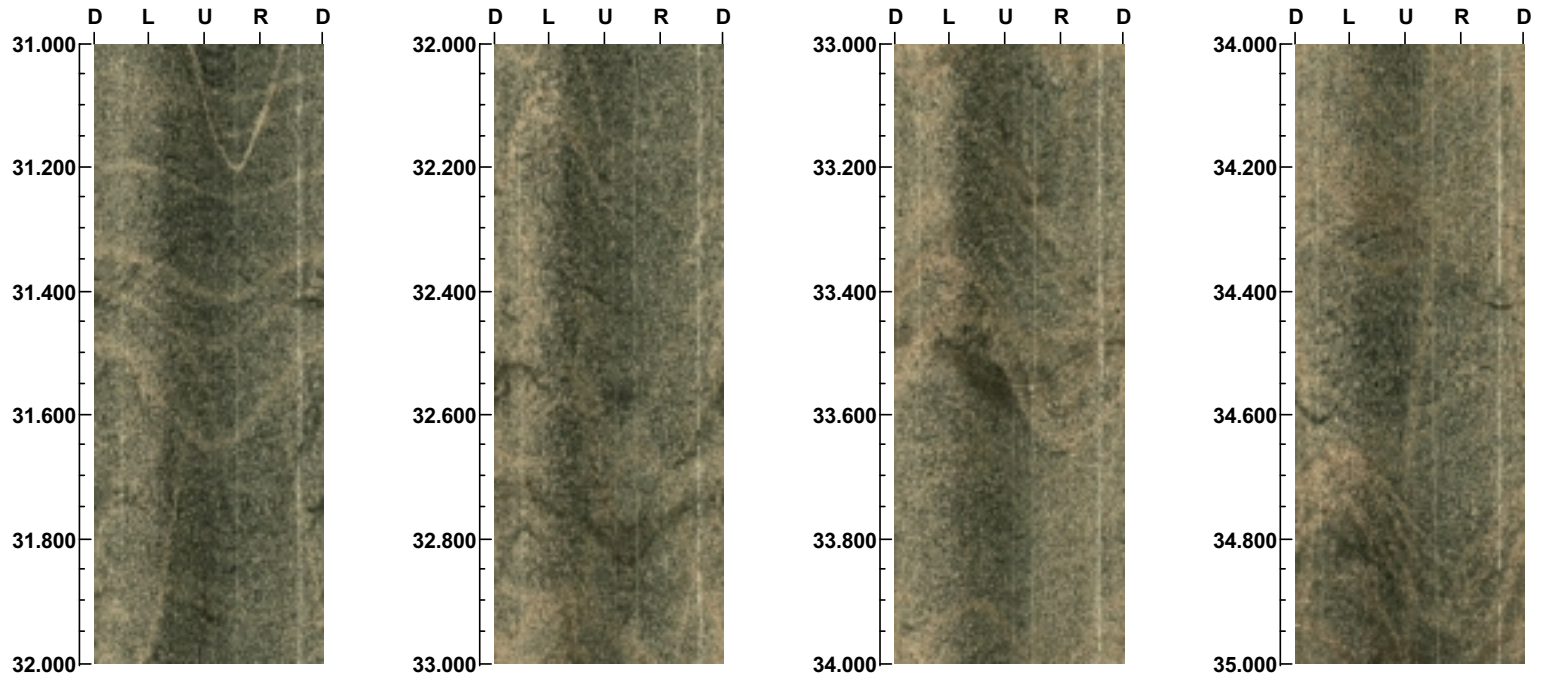



Project name: HSH01  
Bore hole No.: HSH01

Azimuth: 0      Inclination: -90

Depth range: 35.000 - 39.000 m

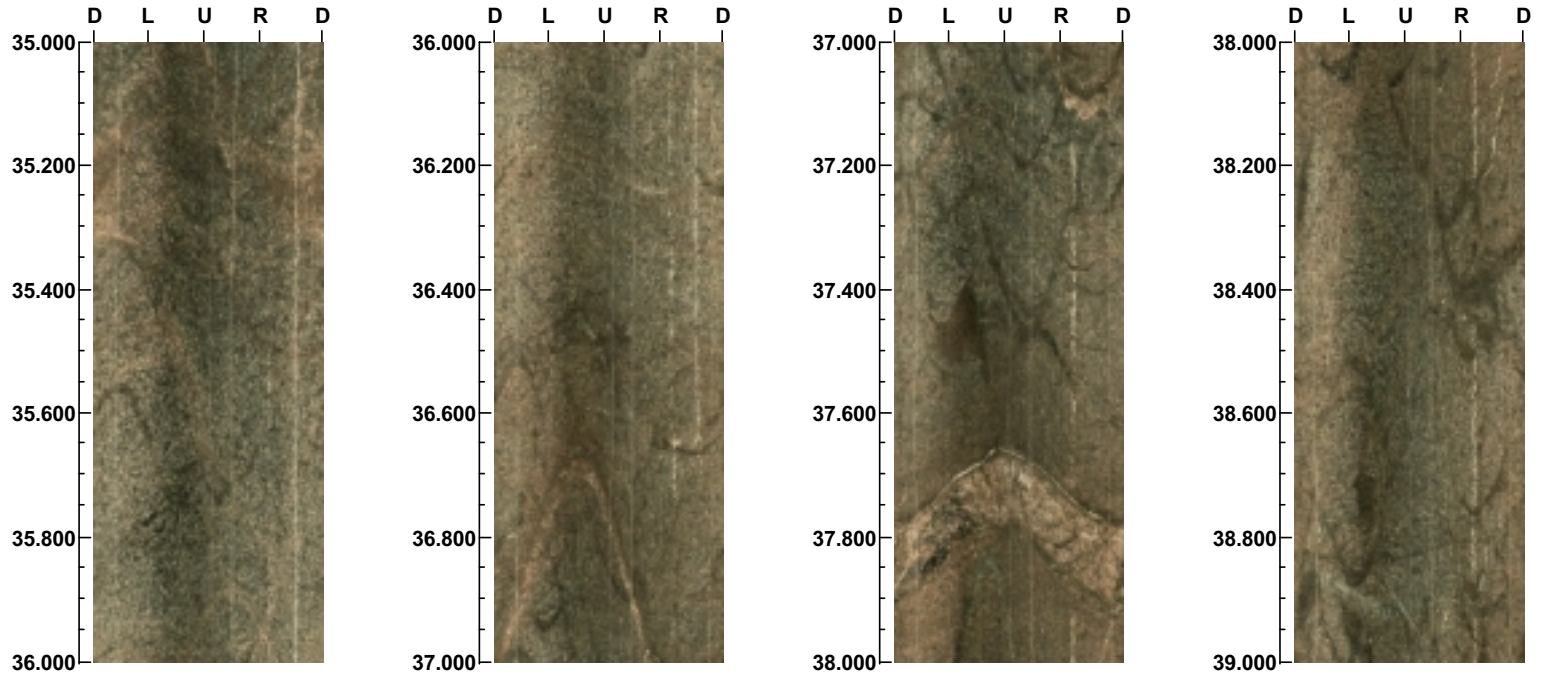

88

( 7 / 31 )

Scale: 1/10      Aspect ratio: 89 %

Project name: HSH01  
Bore hole No.: HSH01

Azimuth: 0      Inclination: -90

Depth range: 39.000 - 43.000 m

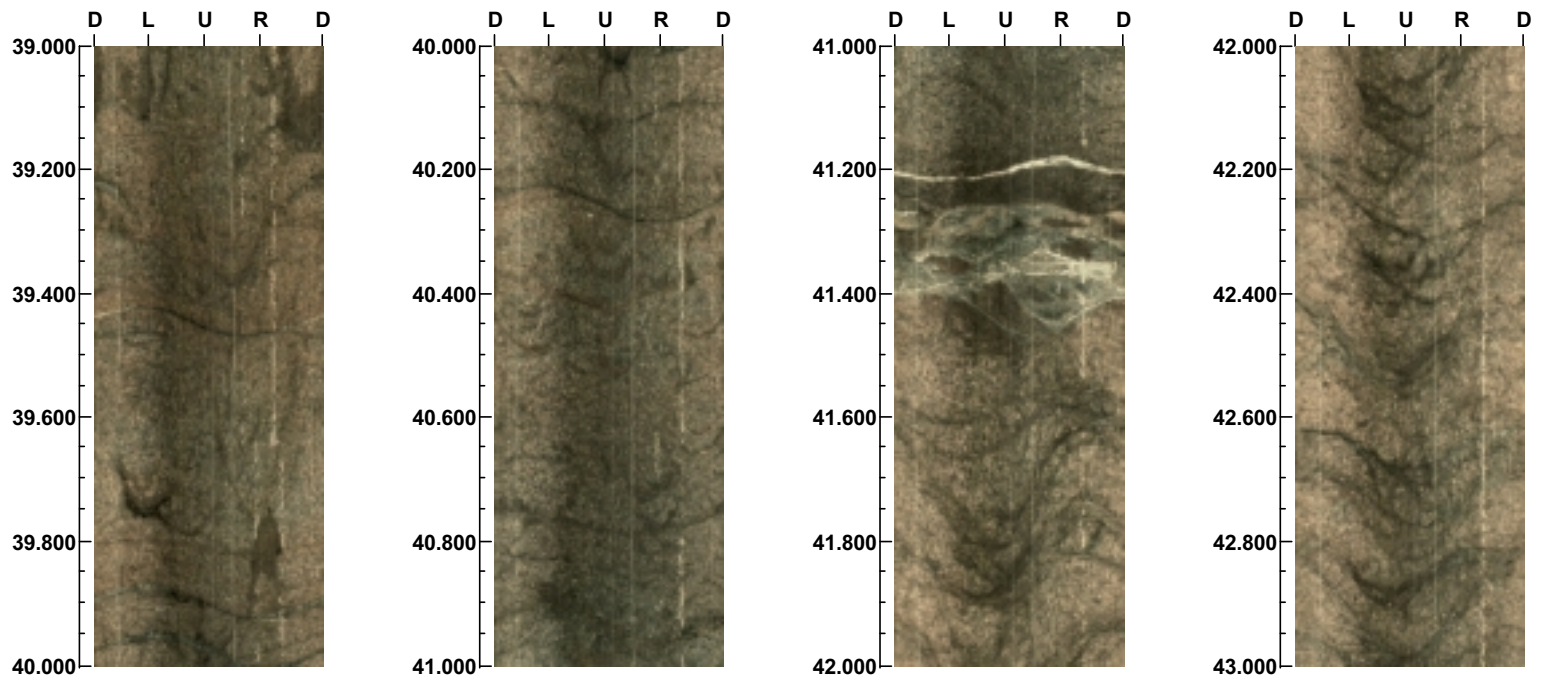



Project name: HSH01  
Bore hole No.: HSH01

Azimuth: 0      Inclination: -90

Depth range: 43.000 - 47.000 m

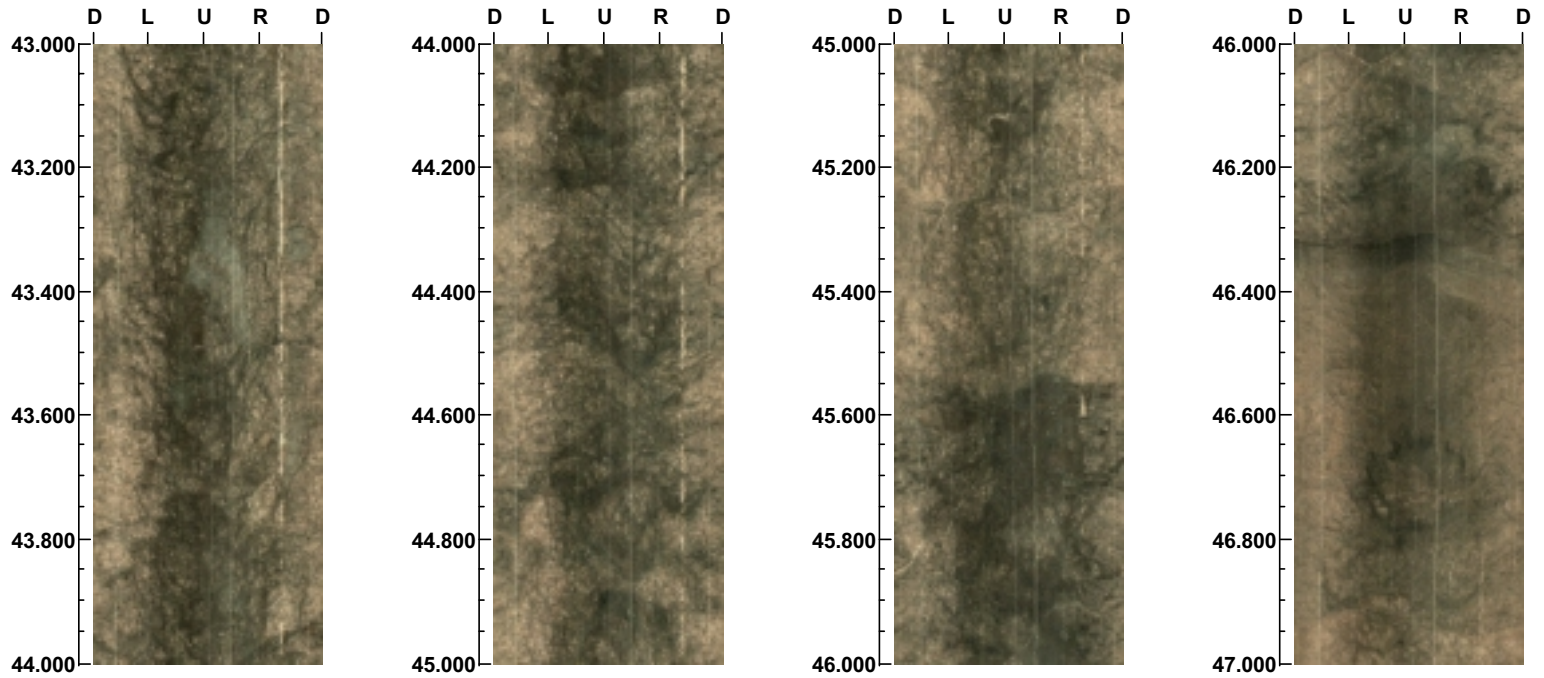

06

( 9 / 31 )

Scale: 1/10      Aspect ratio: 89 %

Project name: HSH01  
Bore hole No.: HSH01

Azimuth: 0      Inclination: -90

Depth range: 47.000 - 51.000 m

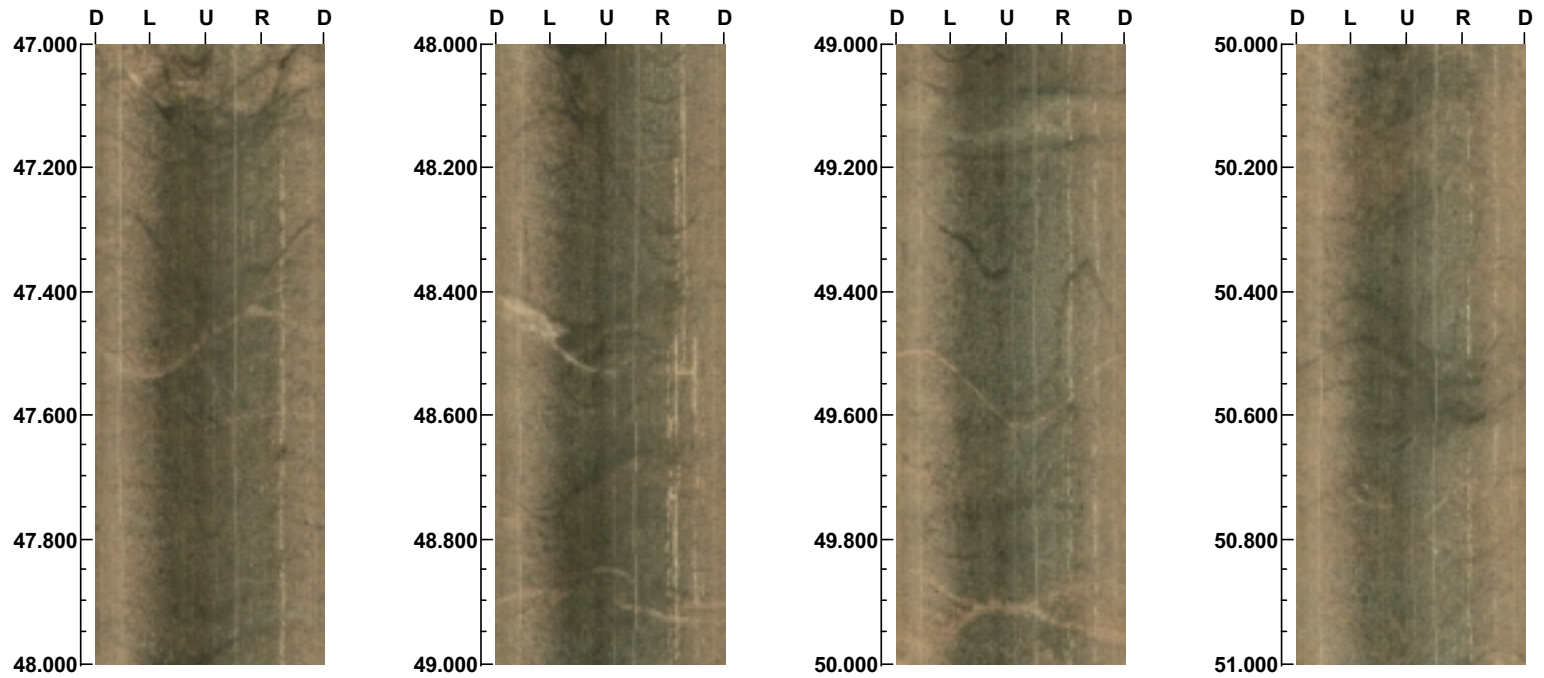

Project name: HSH01  
Bore hole No.: HSH01

Azimuth: 0      Inclination: -90

Depth range: 51.000 - 55.000 m

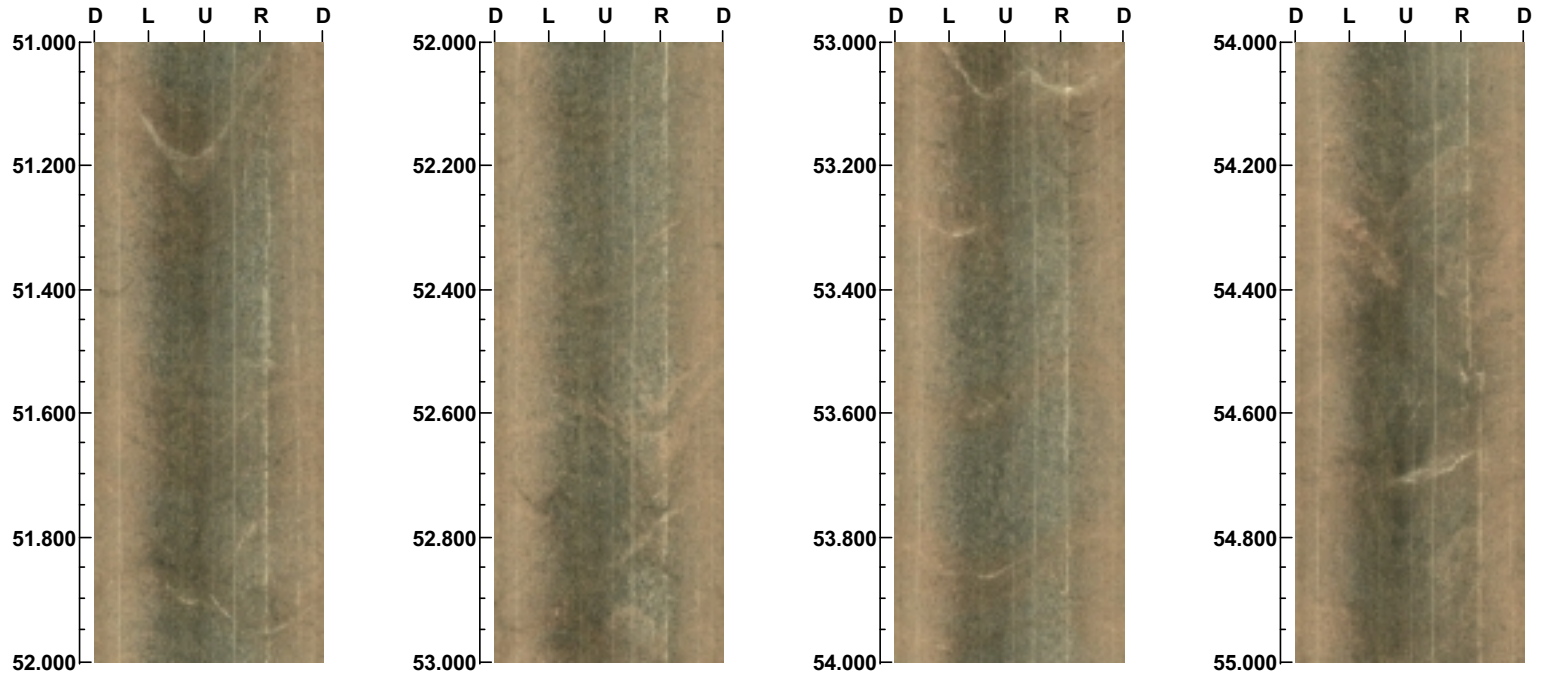

Project name: HSH01  
Bore hole No.: HSH01

Azimuth: 0      Inclination: -90

Depth range: 55.000 - 59.000 m

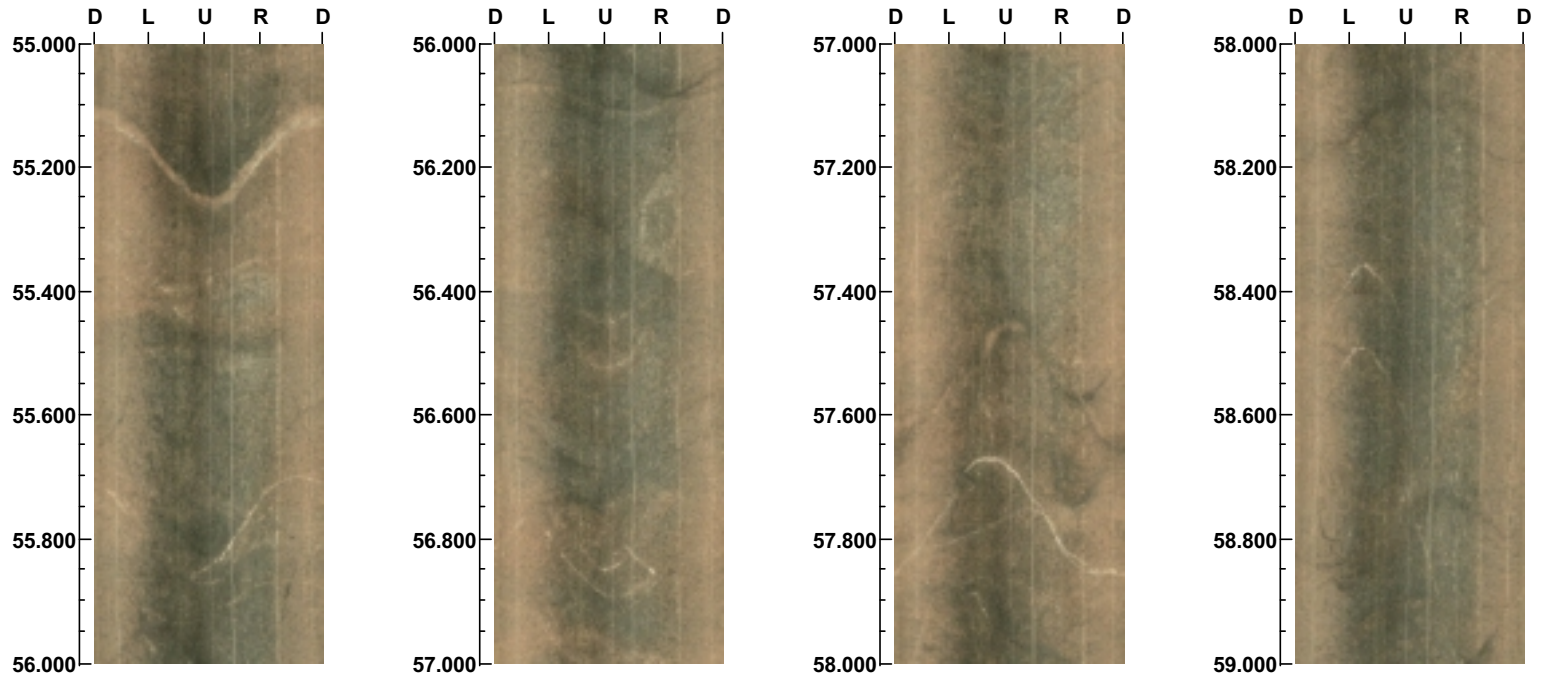

Project name: HSH01  
Bore hole No.: HSH01

Azimuth: 0      Inclination: -90

Depth range: 59.000 - 63.000 m

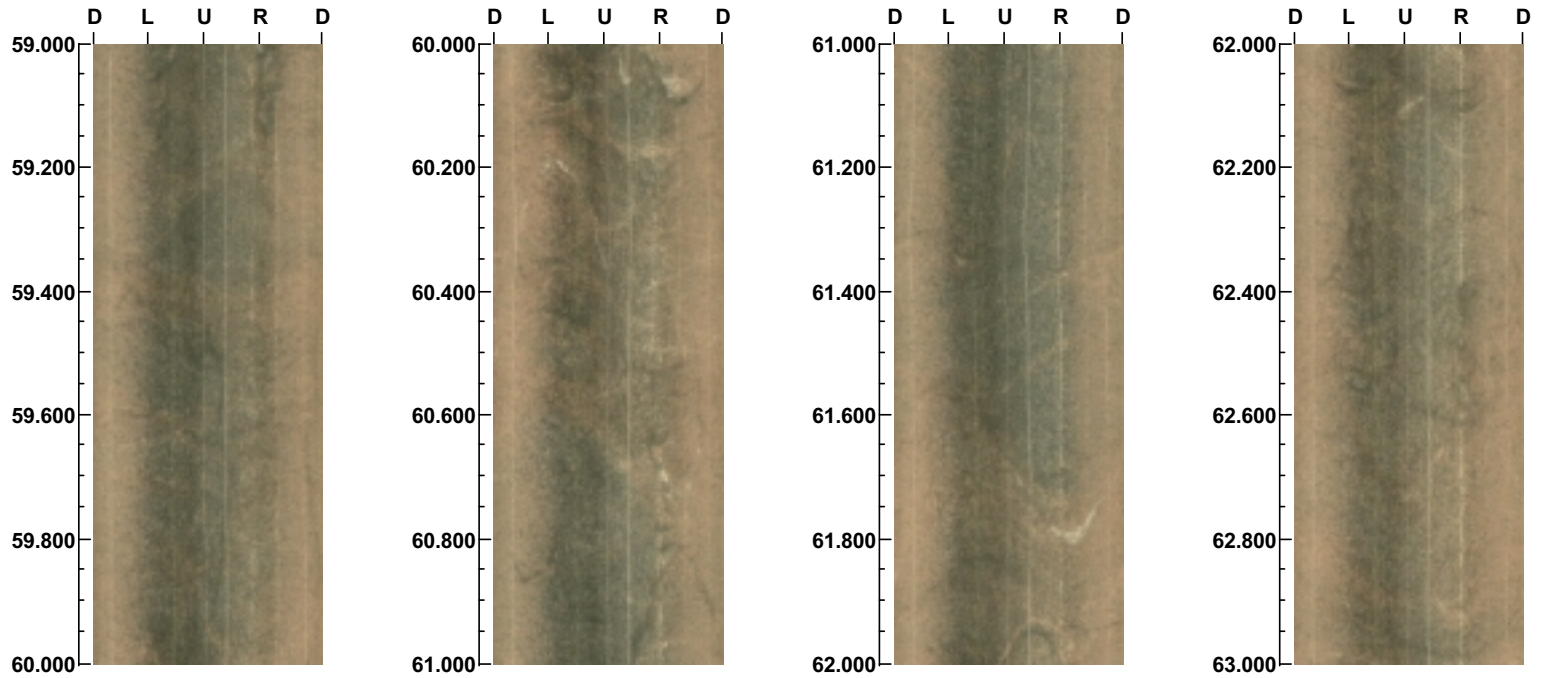

Project name: HSH01  
Bore hole No.: HSH01

Azimuth: 0      Inclination: -90

Depth range: 63.000 - 67.000 m

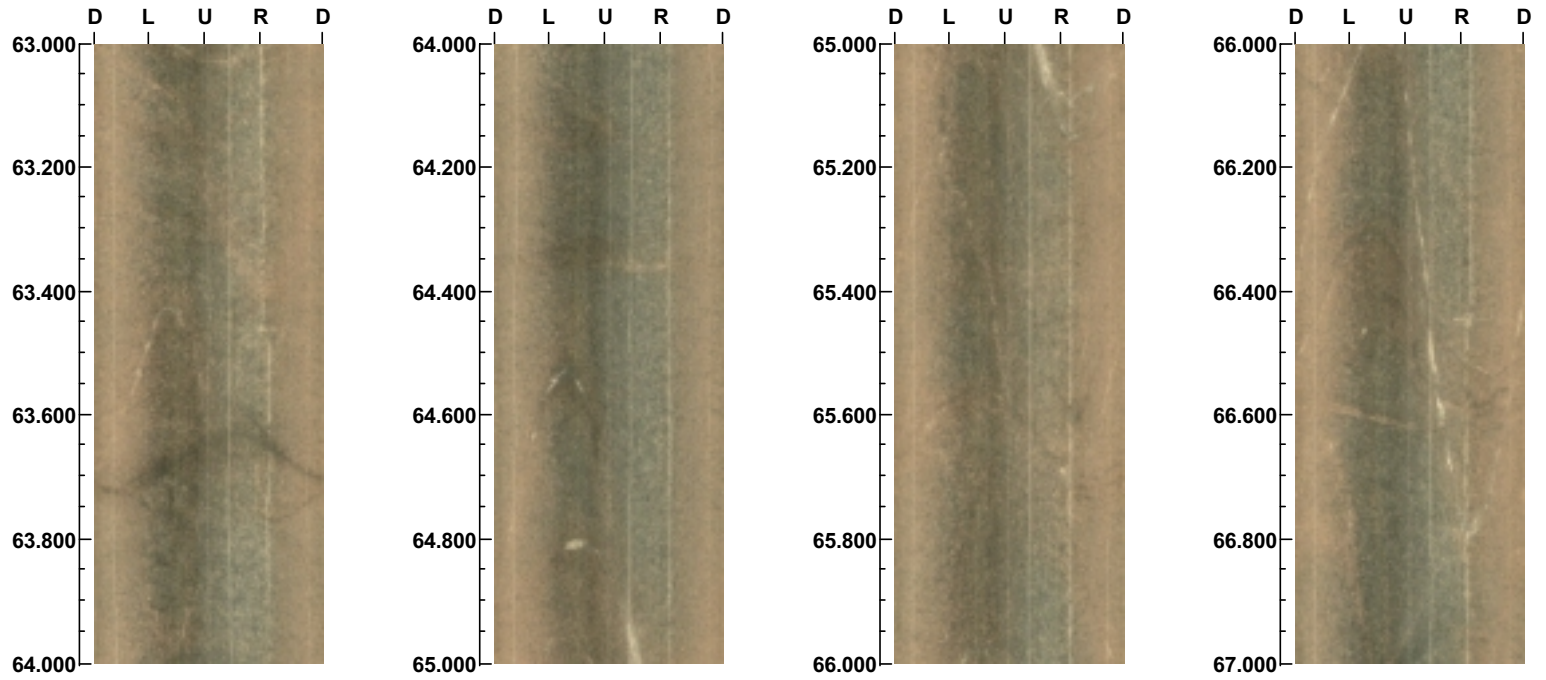

95



Project name: HSH01  
Bore hole No.: HSH01

Azimuth: 0      Inclination: -90

Depth range: 67.000 - 71.000 m

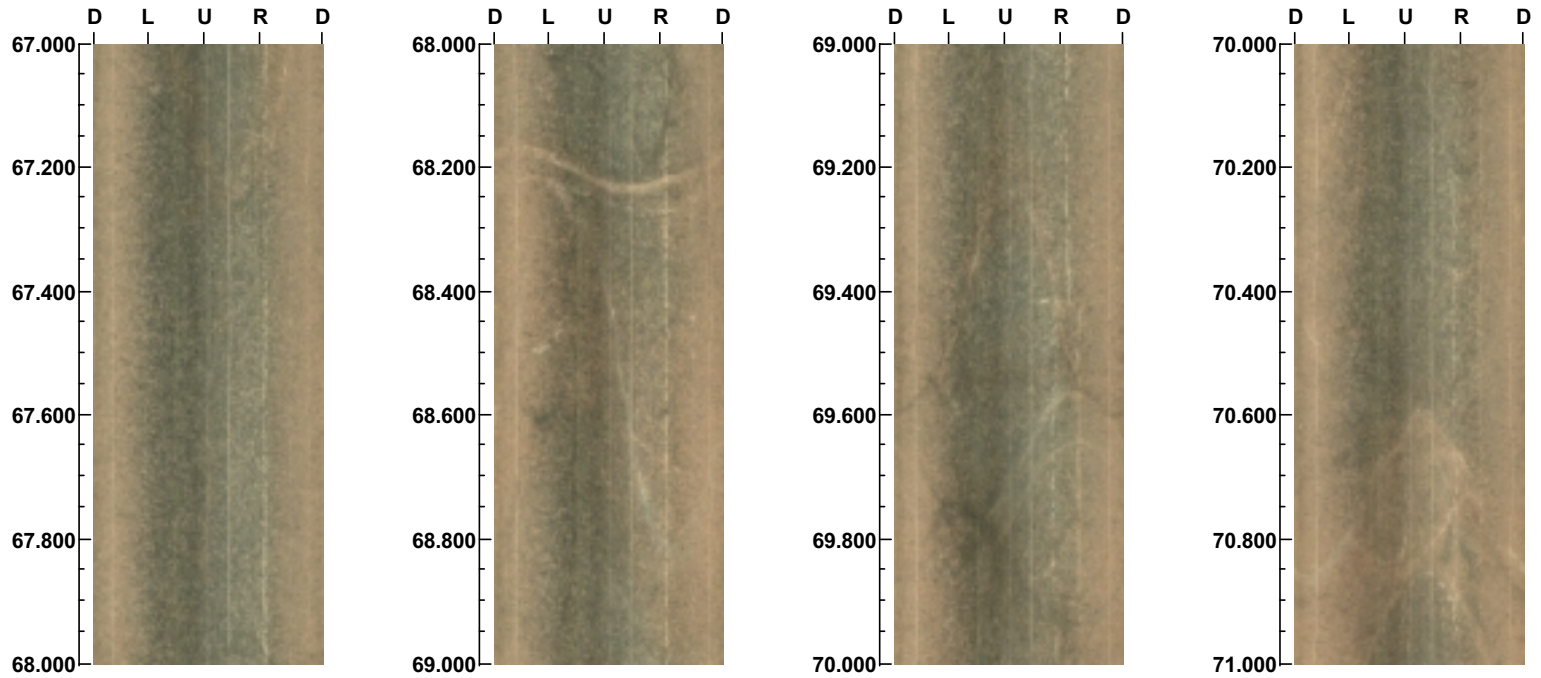



Project name: HSH01  
Bore hole No.: HSH01

Azimuth: 0      Inclination: -90

Depth range: 71.000 - 75.000 m

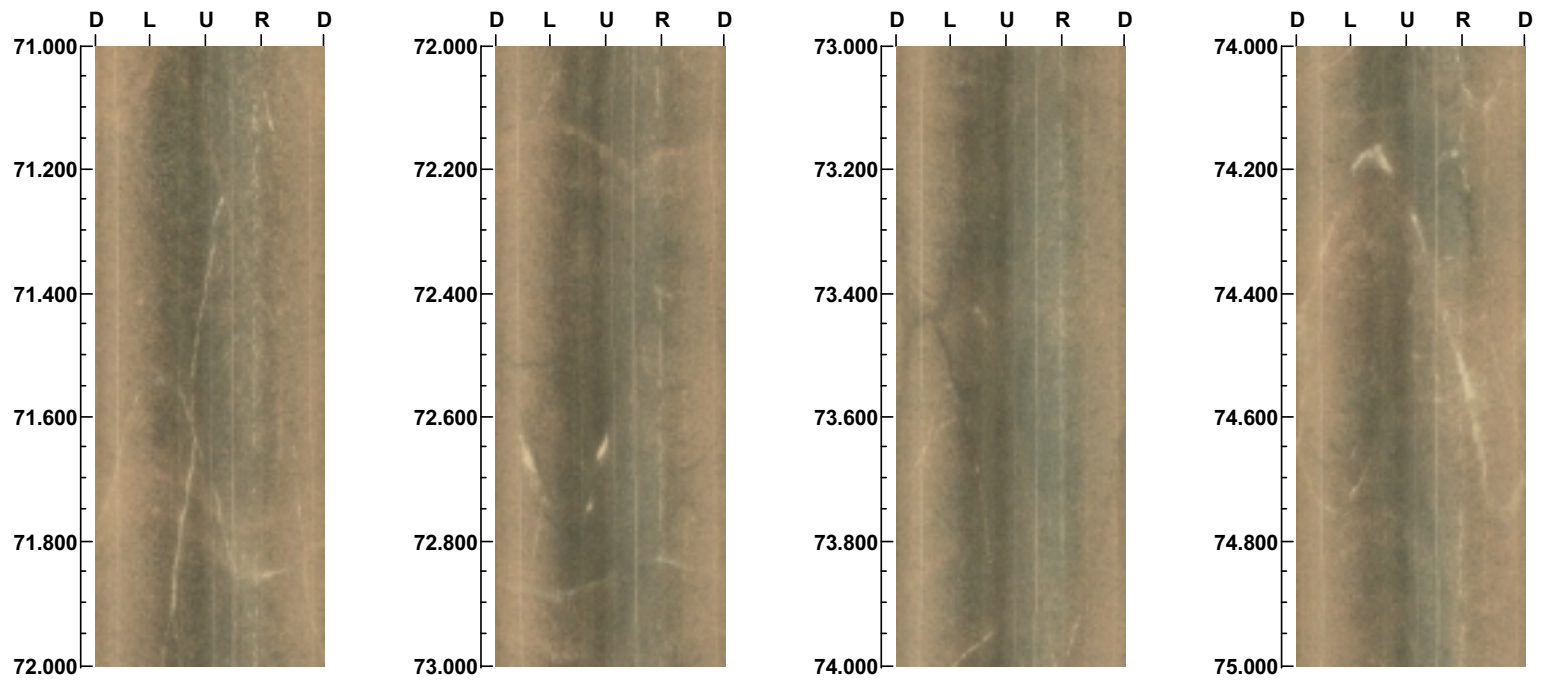

Project name: HSH01  
Bore hole No.: HSH01

Azimuth: 0      Inclination: -90

Depth range: 75.000 - 79.000 m

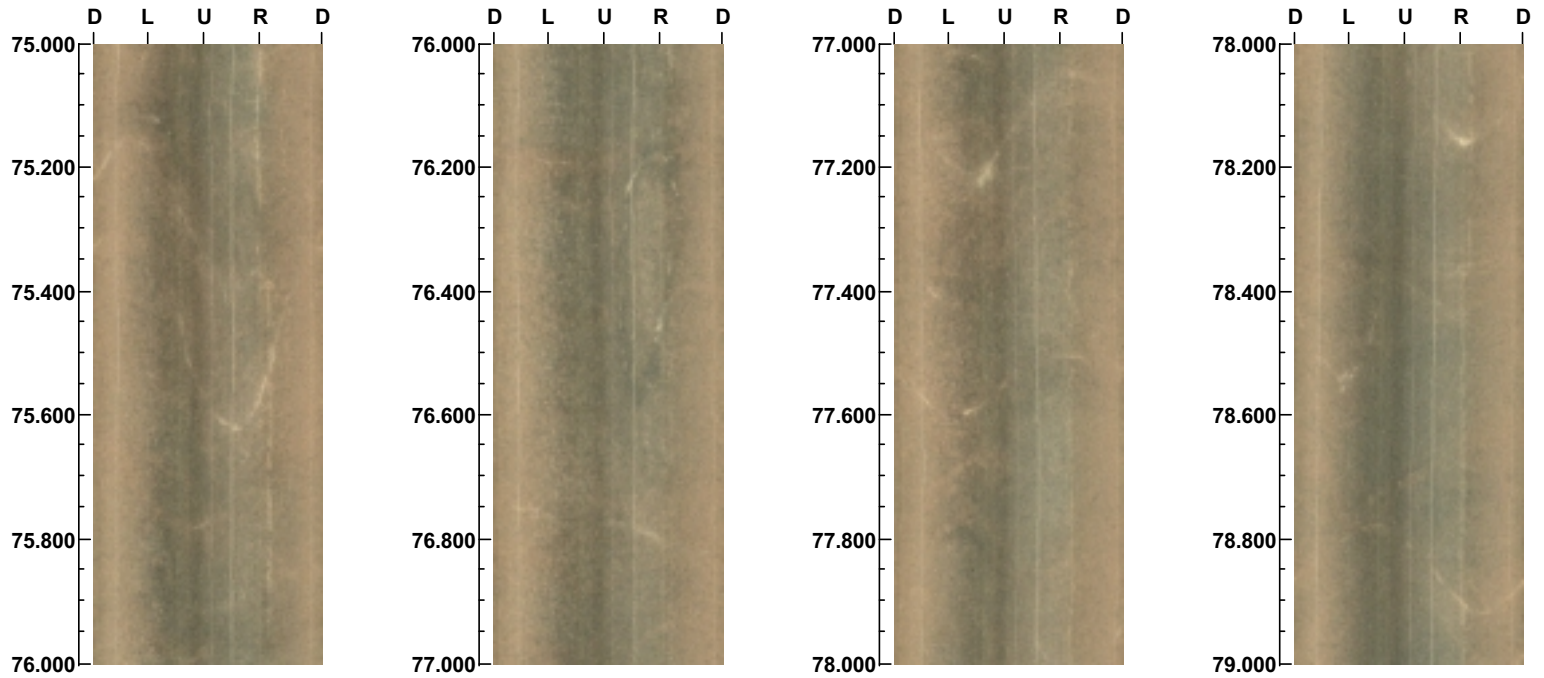

Project name: HSH01  
Bore hole No.: HSH01

Azimuth: 0      Inclination: -90

Depth range: 79.000 - 83.000 m

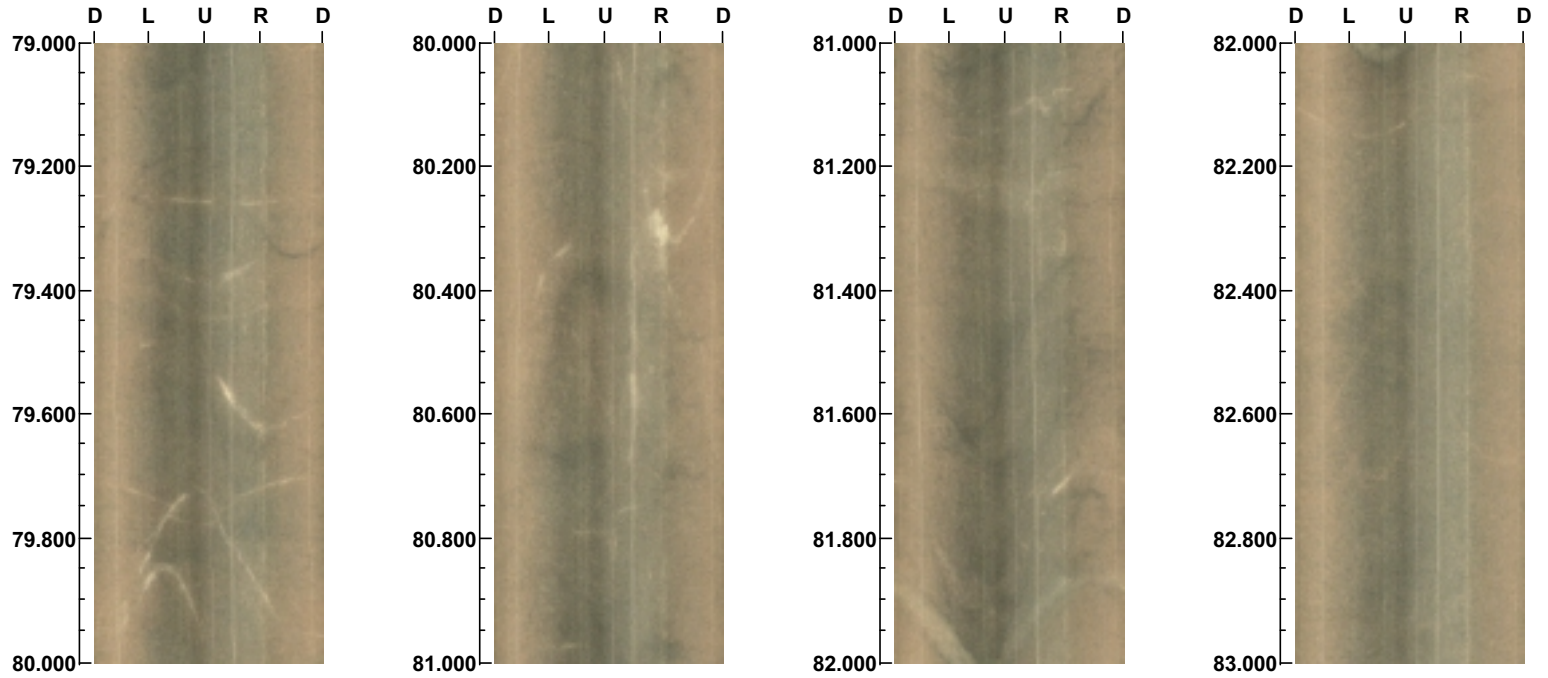

Project name: HSH01  
Bore hole No.: HSH01

Azimuth: 0      Inclination: -90

Depth range: 83.000 - 87.000 m

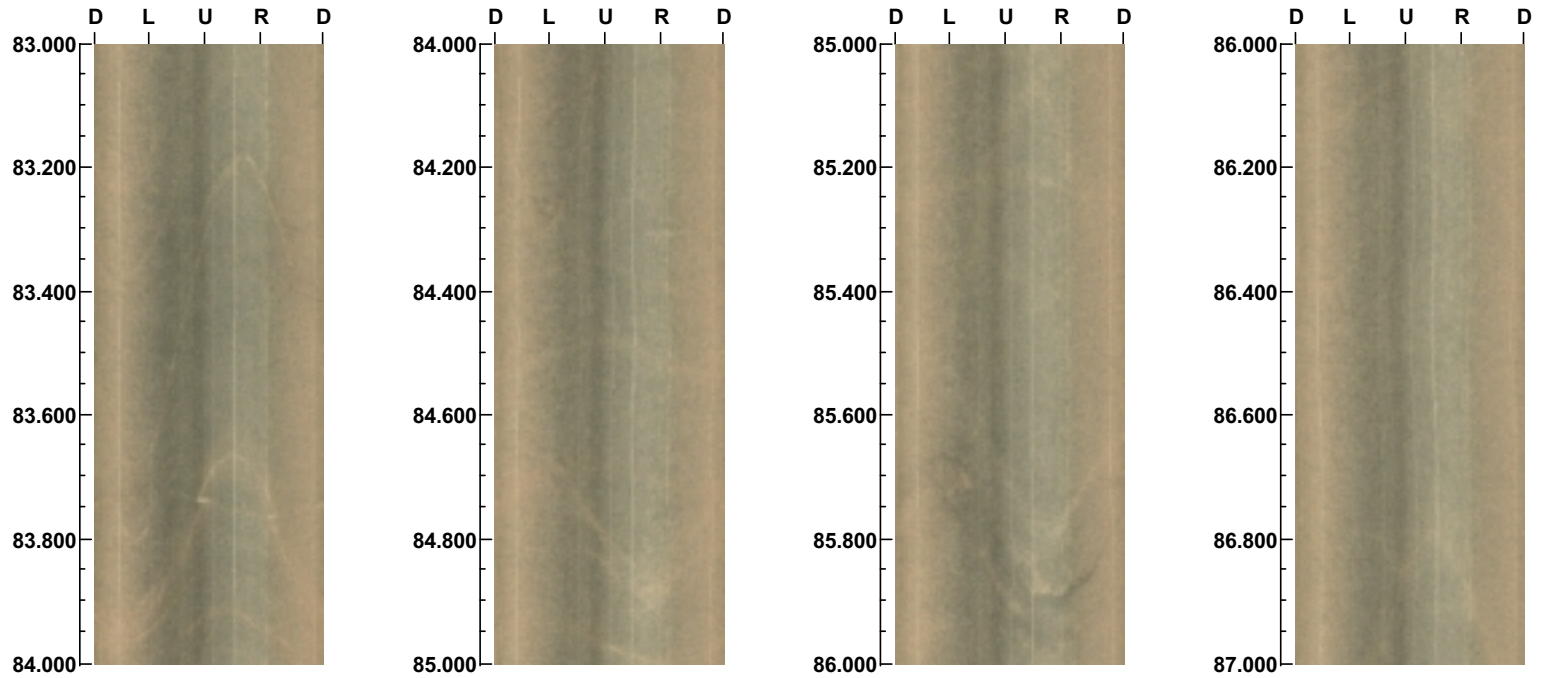

100

Project name: HSH01  
Bore hole No.: HSH01

Azimuth: 0      Inclination: -90

Depth range: 87.000 - 91.000 m

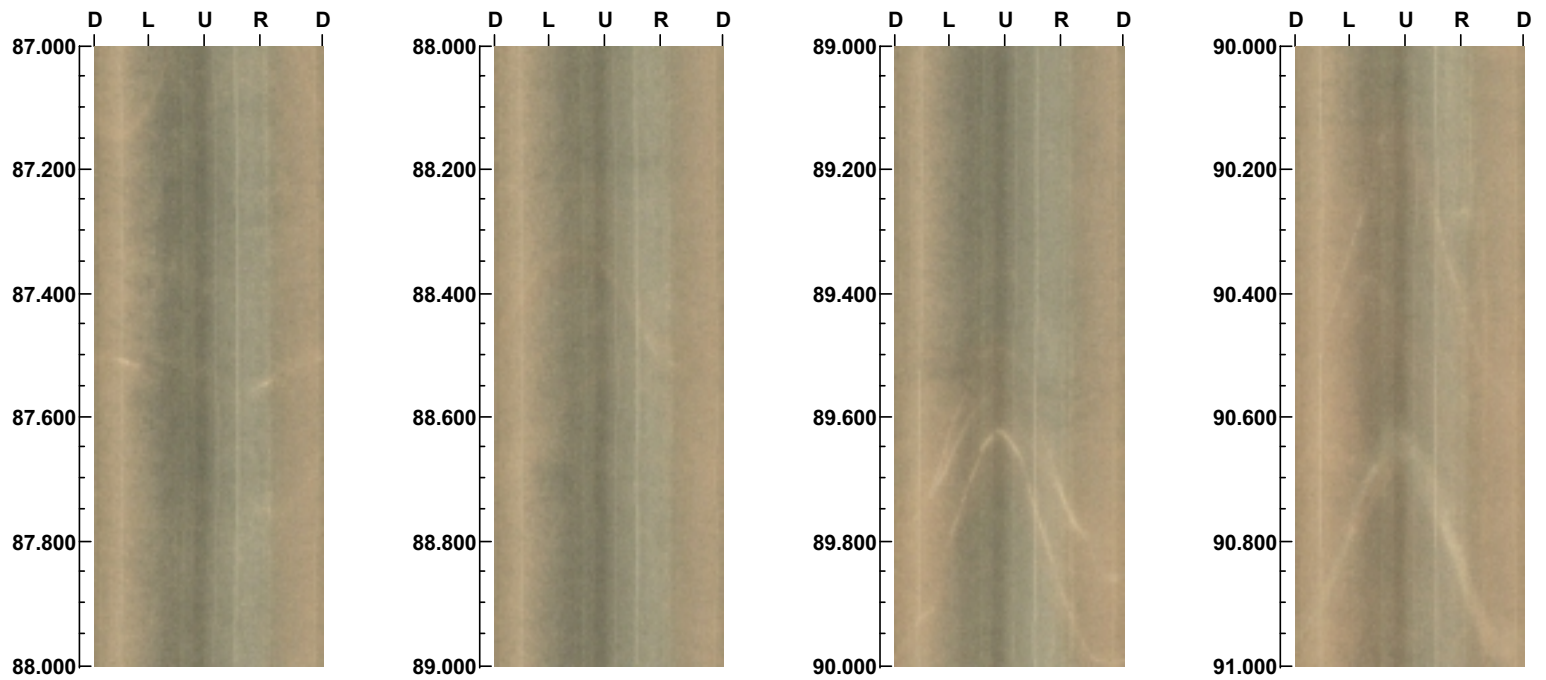

101

Project name: HSH01  
Bore hole No.: HSH01

Azimuth: 0      Inclination: -90

Depth range: 91.000 - 95.000 m

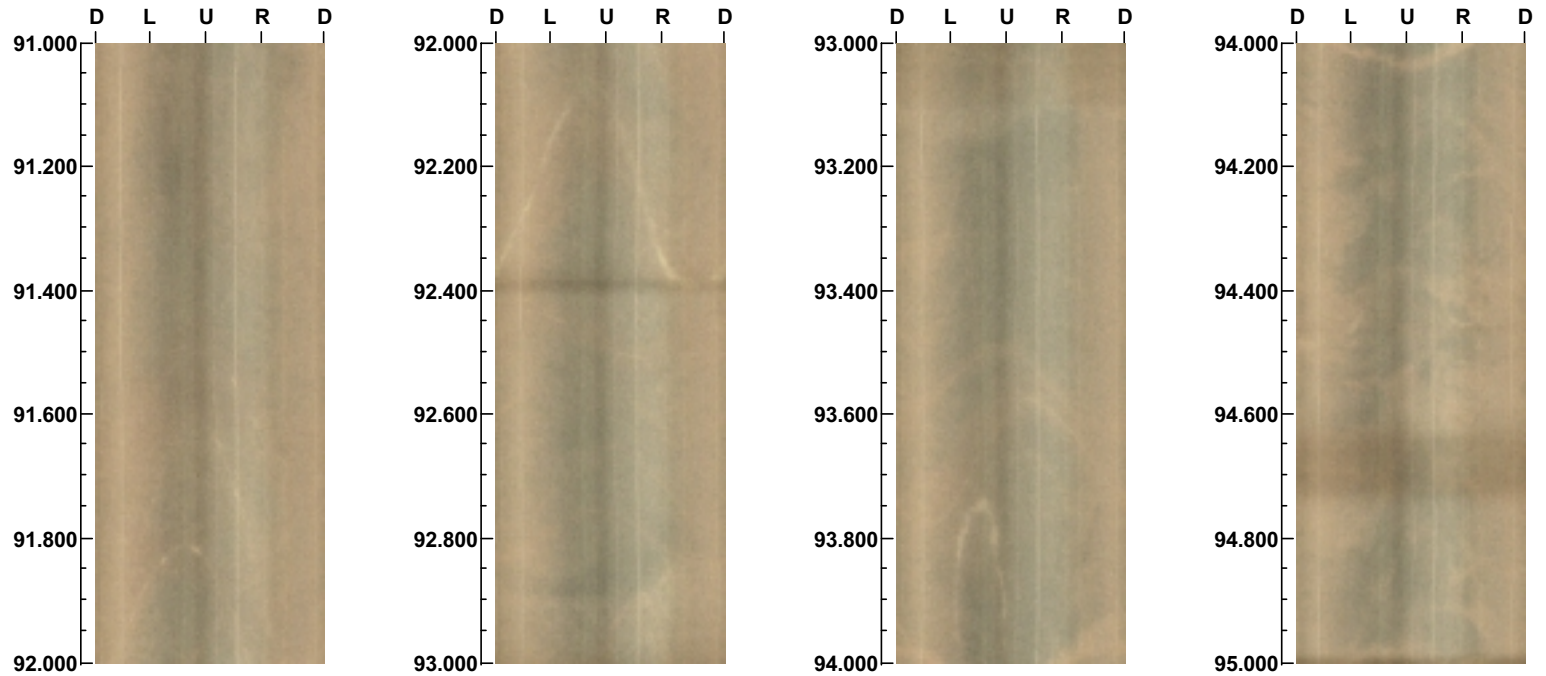

Project name: HSH01  
Bore hole No.: HSH01

Azimuth: 0      Inclination: -90

Depth range: 95.000 - 99.000 m

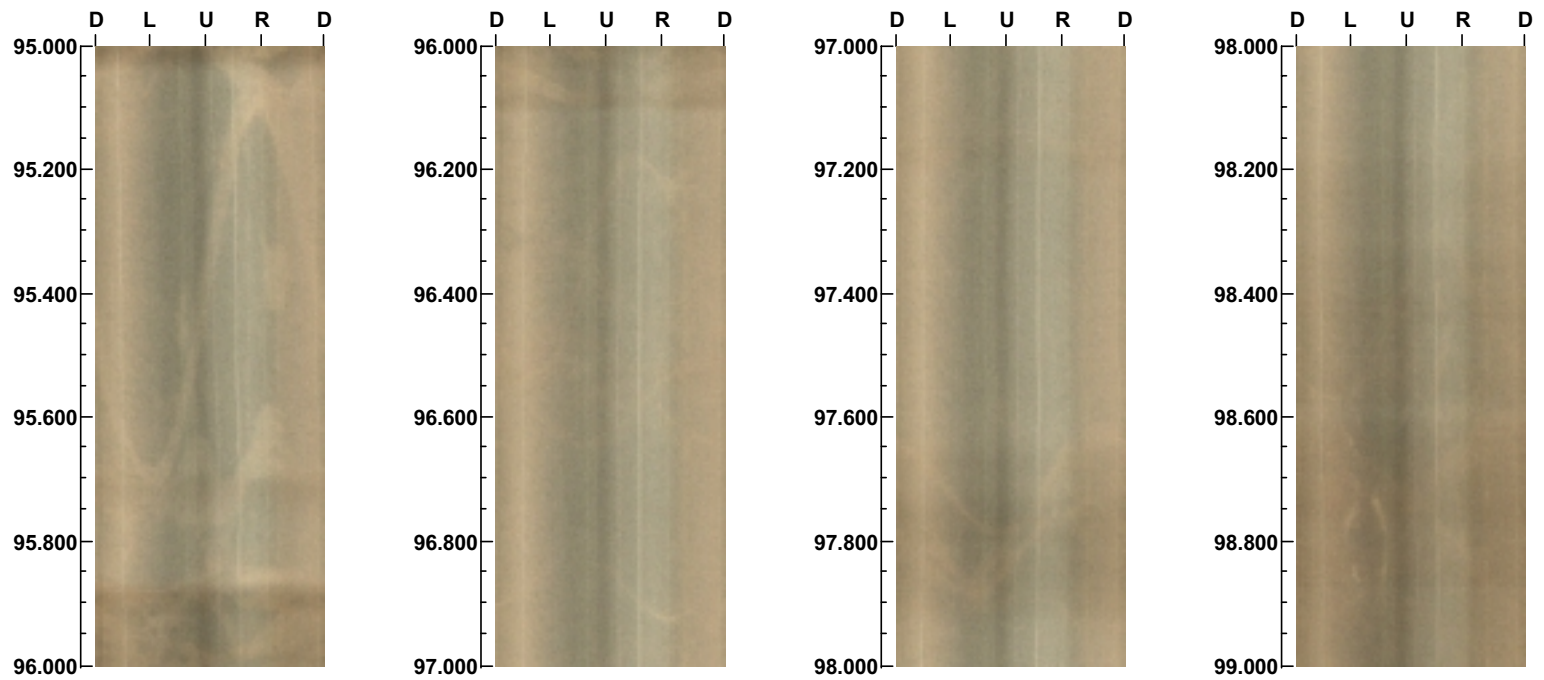



Project name: HSH01  
Bore hole No.: HSH01

Azimuth: 0      Inclination: -90

Depth range: 99.000 - 103.000 m

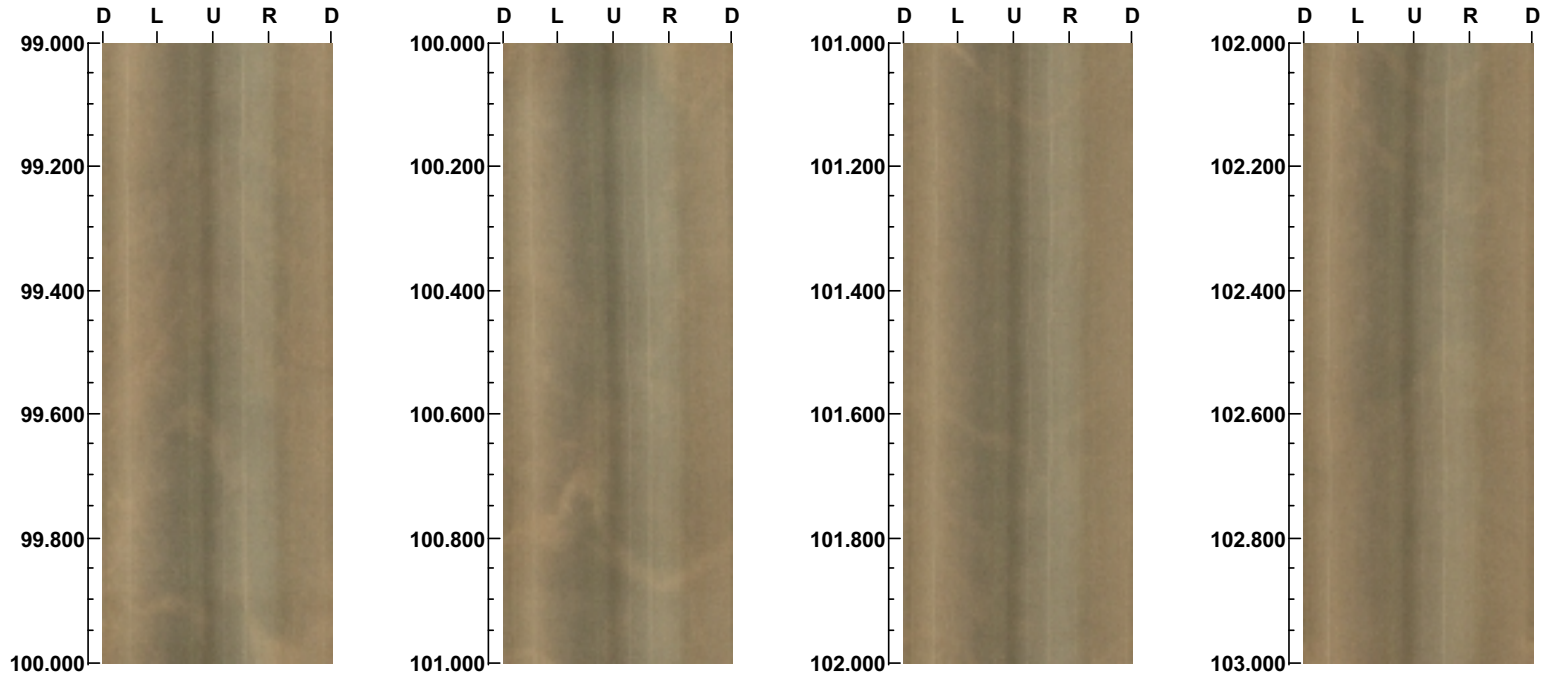

104

( 23 / 31 )

Scale: 1/10      Aspect ratio: 89 %

Project name: HSH01  
Bore hole No.: HSH01

Azimuth: 0      Inclination: -90

Depth range: 103.000 - 107.000 m

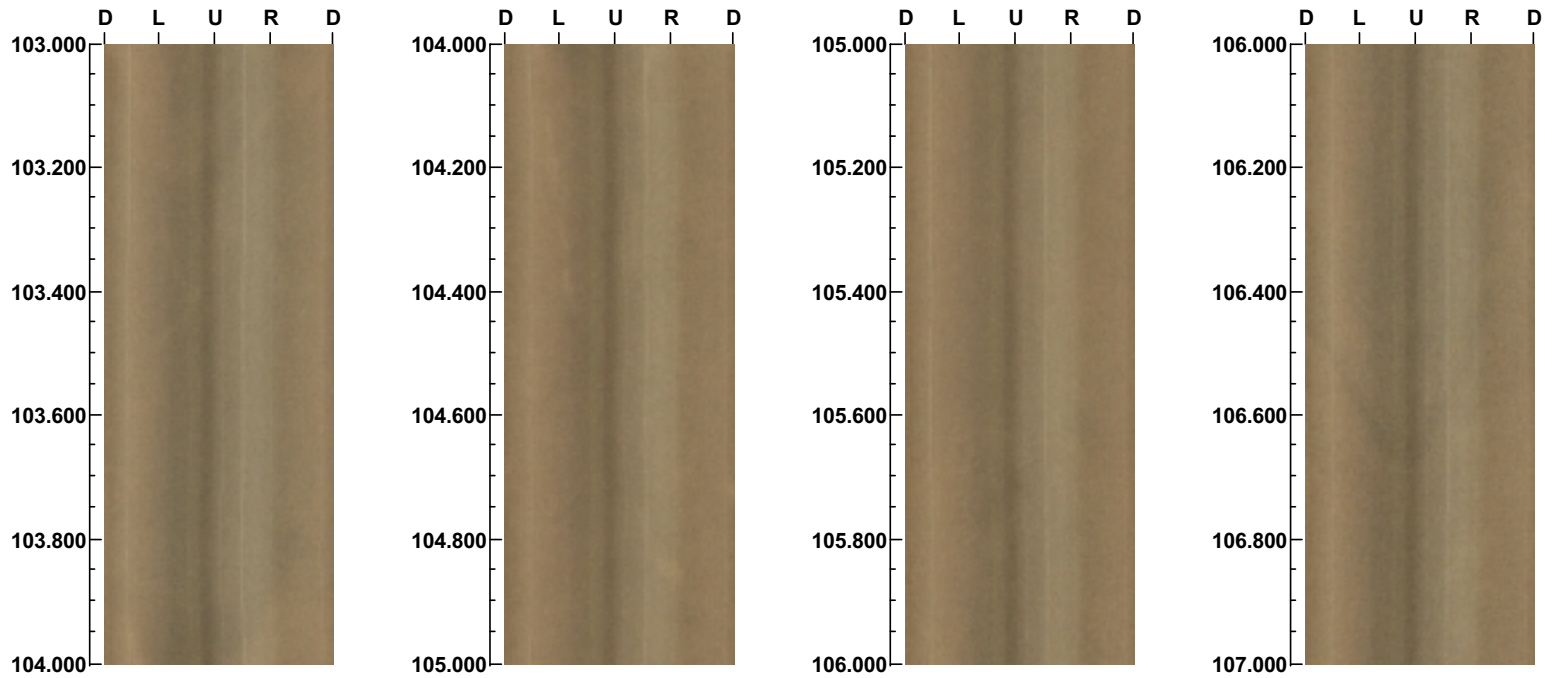

105

Project name: HSH01  
Bore hole No.: HSH01

Azimuth: 0      Inclination: -90

Depth range: 107.000 - 111.000 m

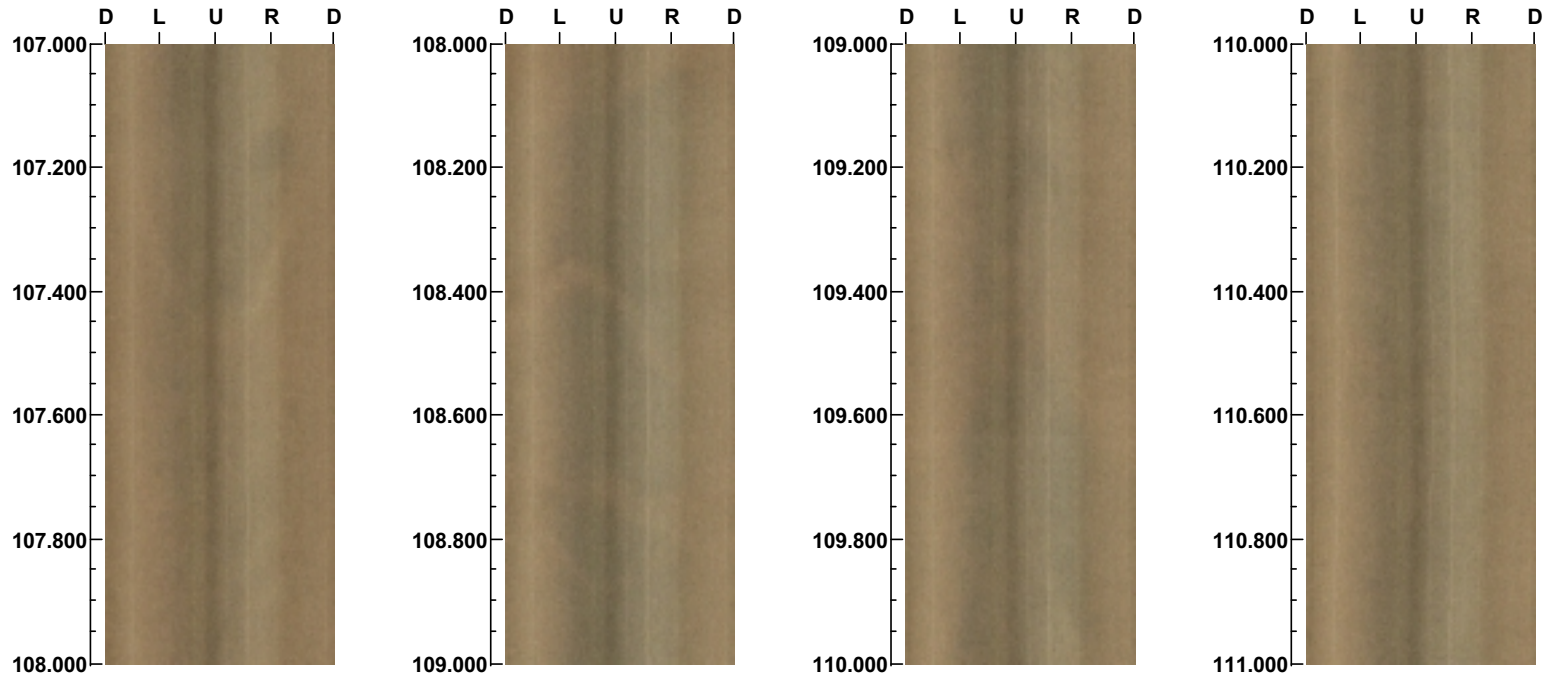

Project name: HSH01  
Bore hole No.: HSH01

Azimuth: 0      Inclination: -90

Depth range: 111.000 - 115.000 m

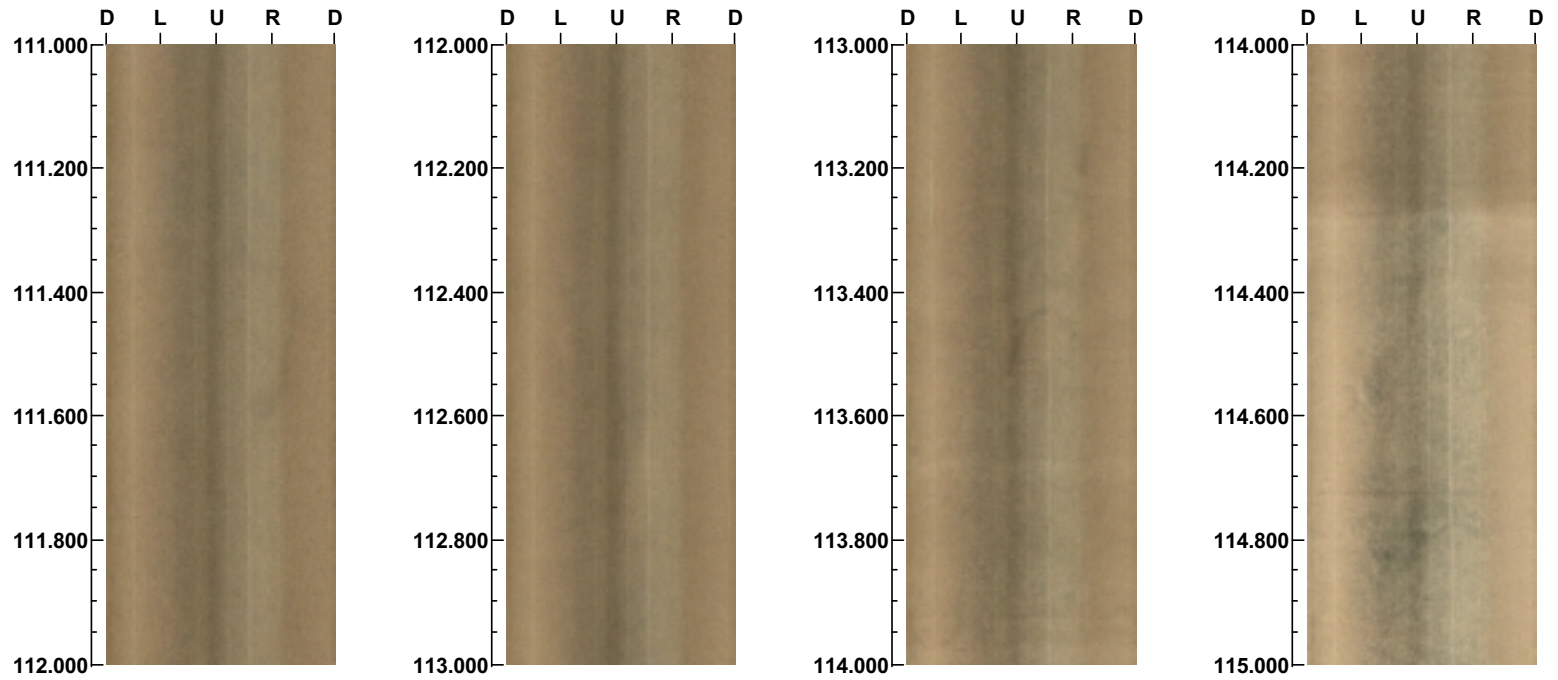

107

Project name: HSH01  
Bore hole No.: HSH01

Azimuth: 0      Inclination: -90

Depth range: 115.000 - 119.000 m

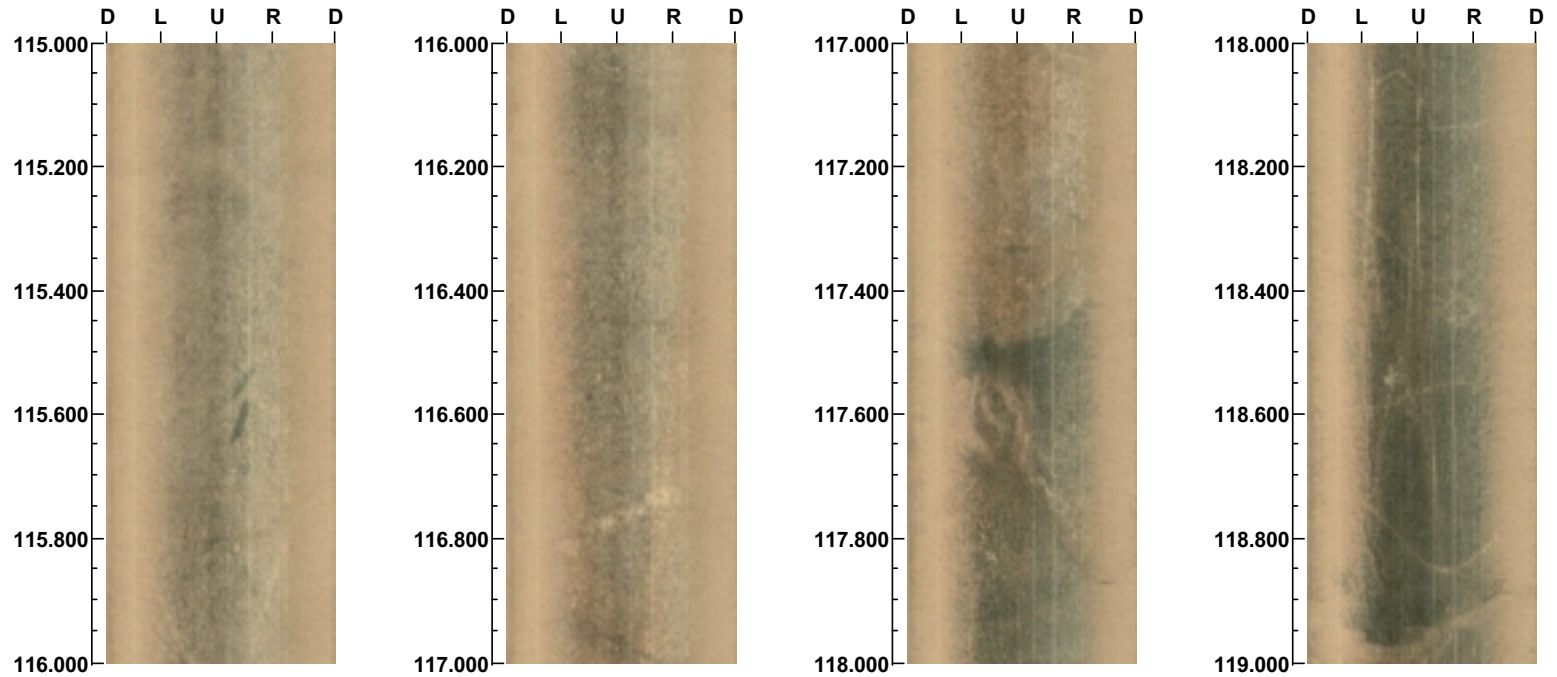

108

( 27 / 31 )

Scale: 1/10      Aspect ratio: 89 %

Project name: HSH01  
Bore hole No.: HSH01

Azimuth: 0      Inclination: -90

Depth range: 119.000 - 123.000 m

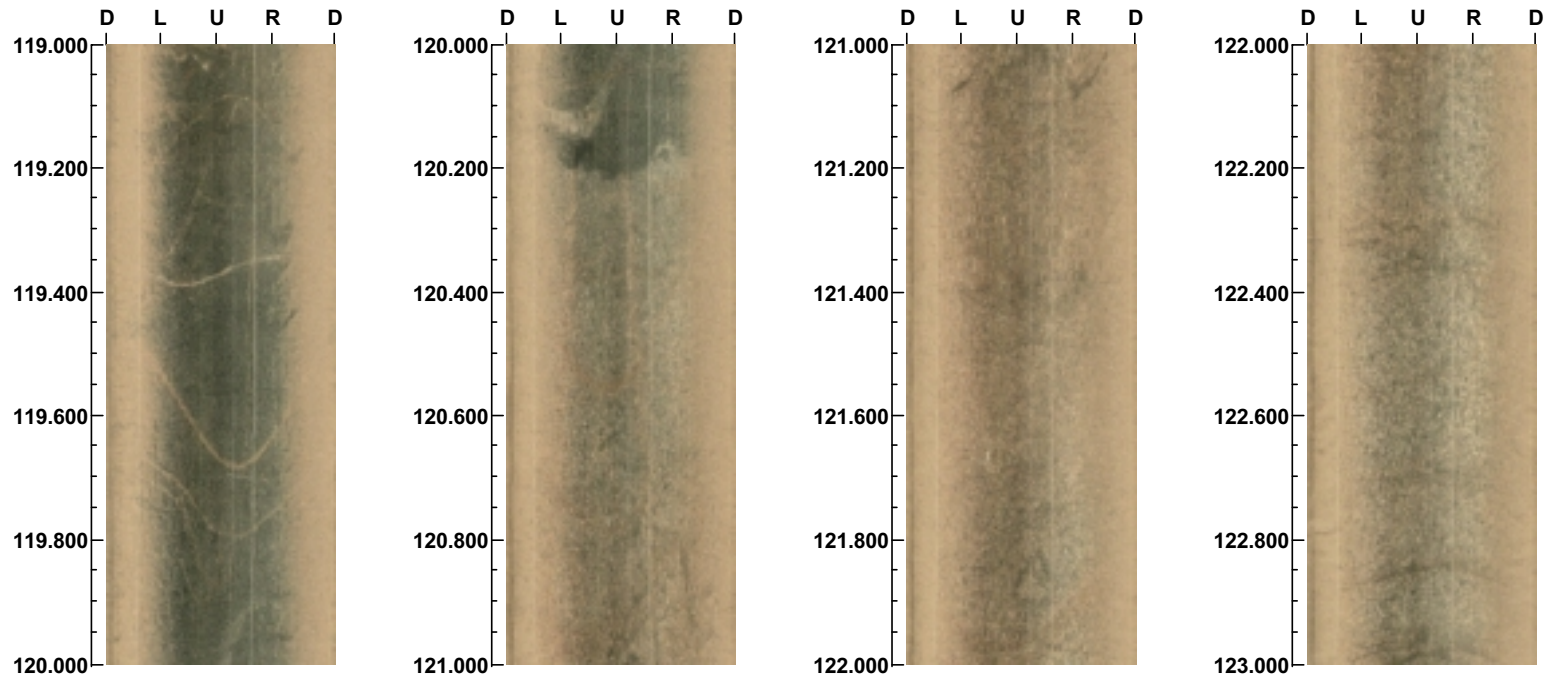

109

Project name: HSH01  
Bore hole No.: HSH01

Azimuth: 0      Inclination: -90

Depth range: 123.000 - 127.000 m

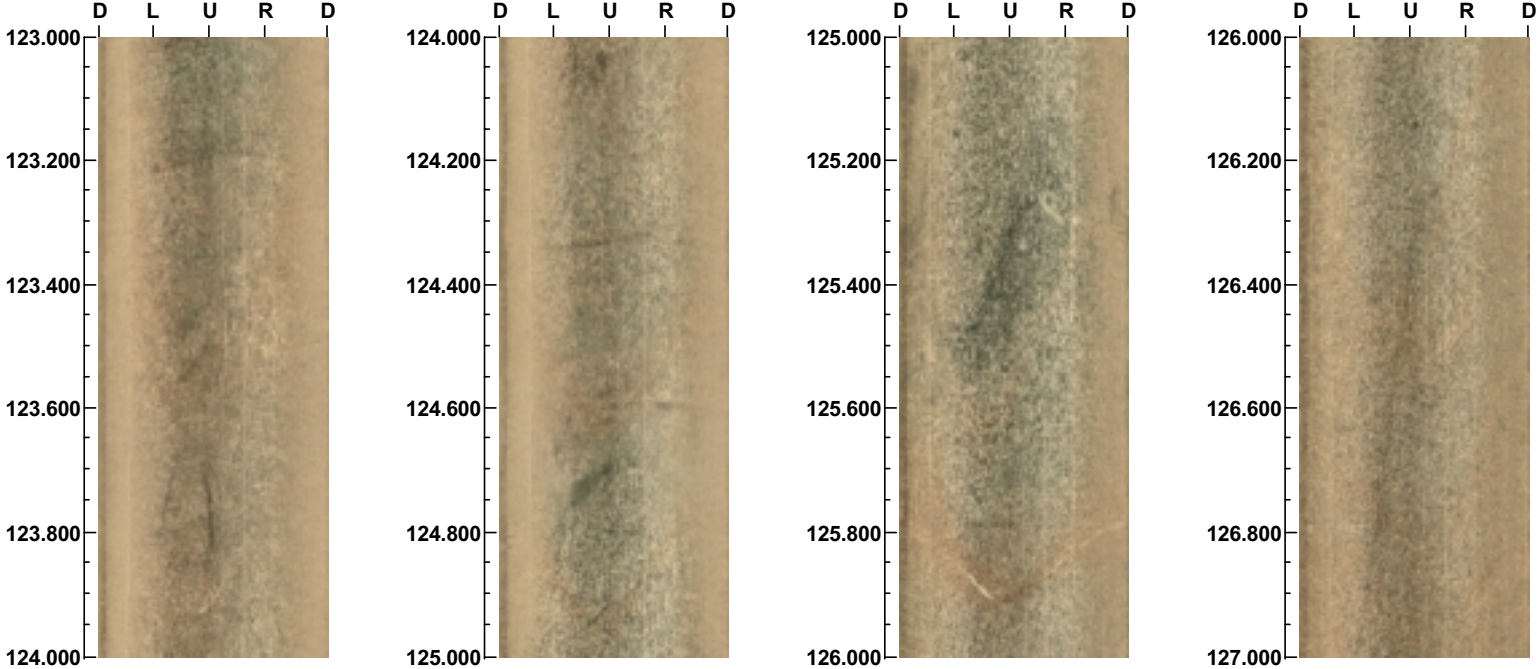

110



Project name: HSH01  
Bore hole No.: HSH01

Azimuth: 0      Inclination: -90

Depth range: 127.000 - 131.000 m

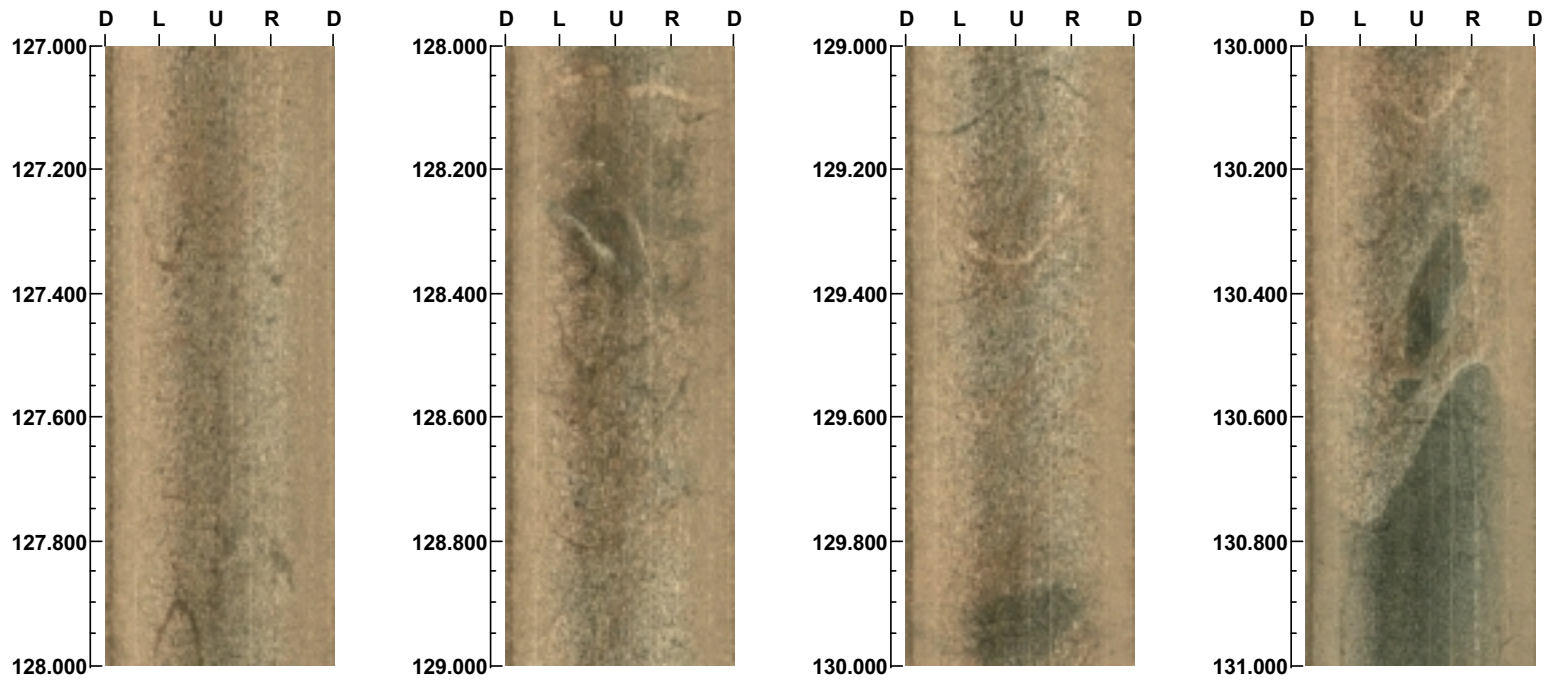

111

Project name: HSH01  
Bore hole No.: HSH01

Azimuth: 0      Inclination: -90

Depth range: 131.000 - 132.000 m

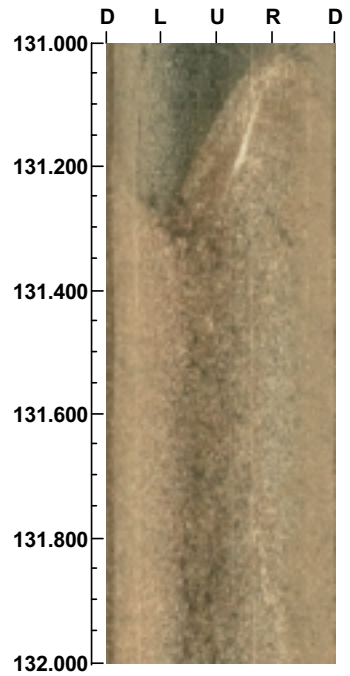

112

( 31 / 31 )

Scale: 1/10      Aspect ratio: 89 %

Project name: HSH01  
Bore hole No.: HSH01

Azimuth: 0      Inclination: -90

Depth range: 132.000 - 136.000 m

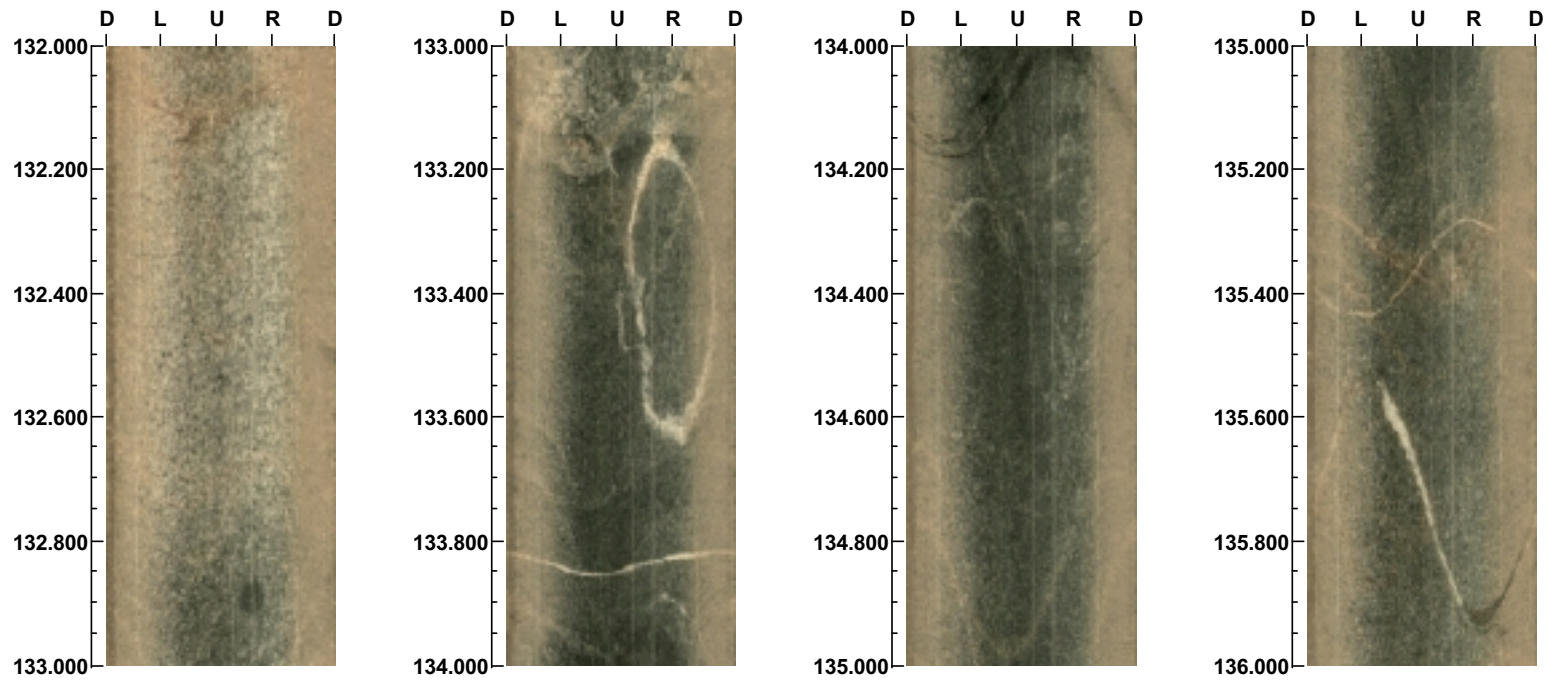

113

( 1 / 7 )

Scale: 1/10      Aspect ratio: 89 %

Project name: HSH01  
Bore hole No.: HSH01

Azimuth: 0      Inclination: -90

Depth range: 136.000 - 140.000 m

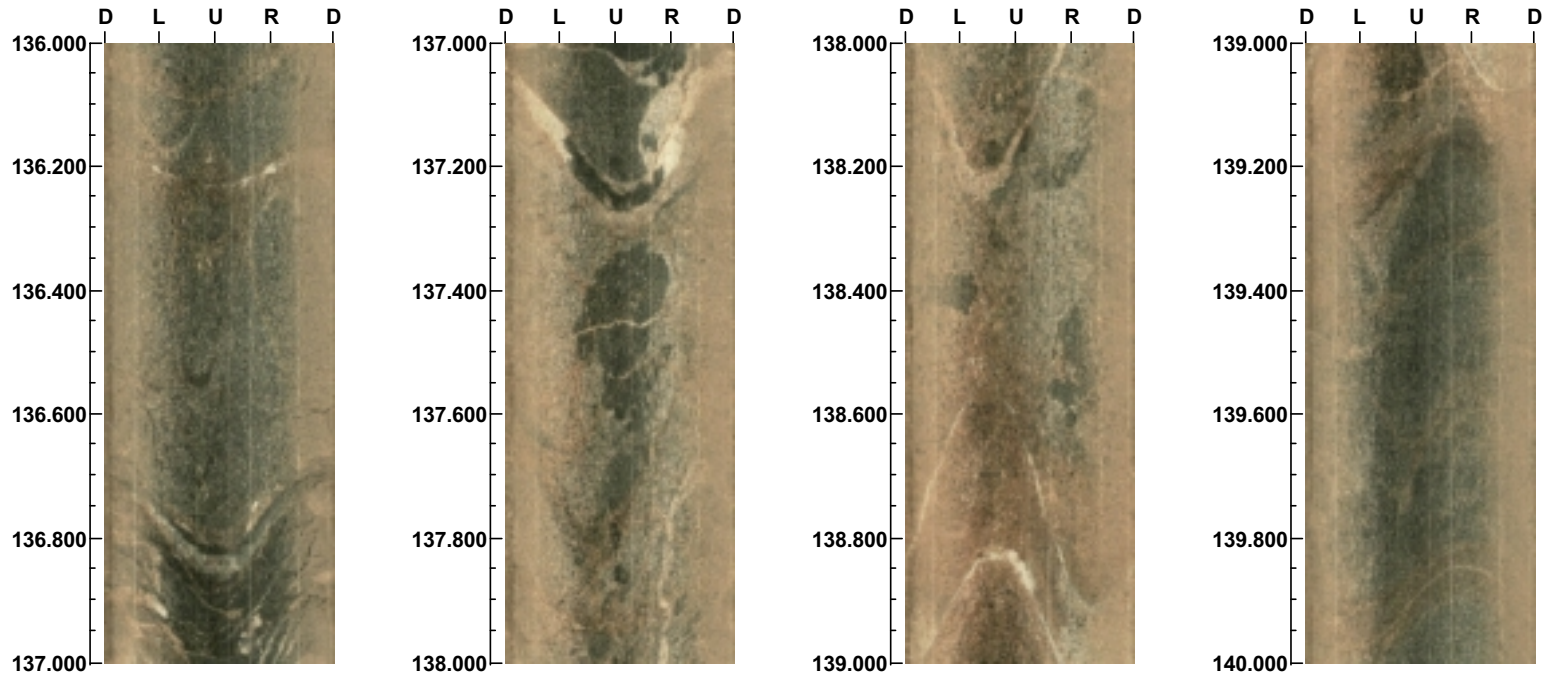

Project name: HSH01  
Bore hole No.: HSH01

Azimuth: 0      Inclination: -90

Depth range: 140.000 - 144.000 m

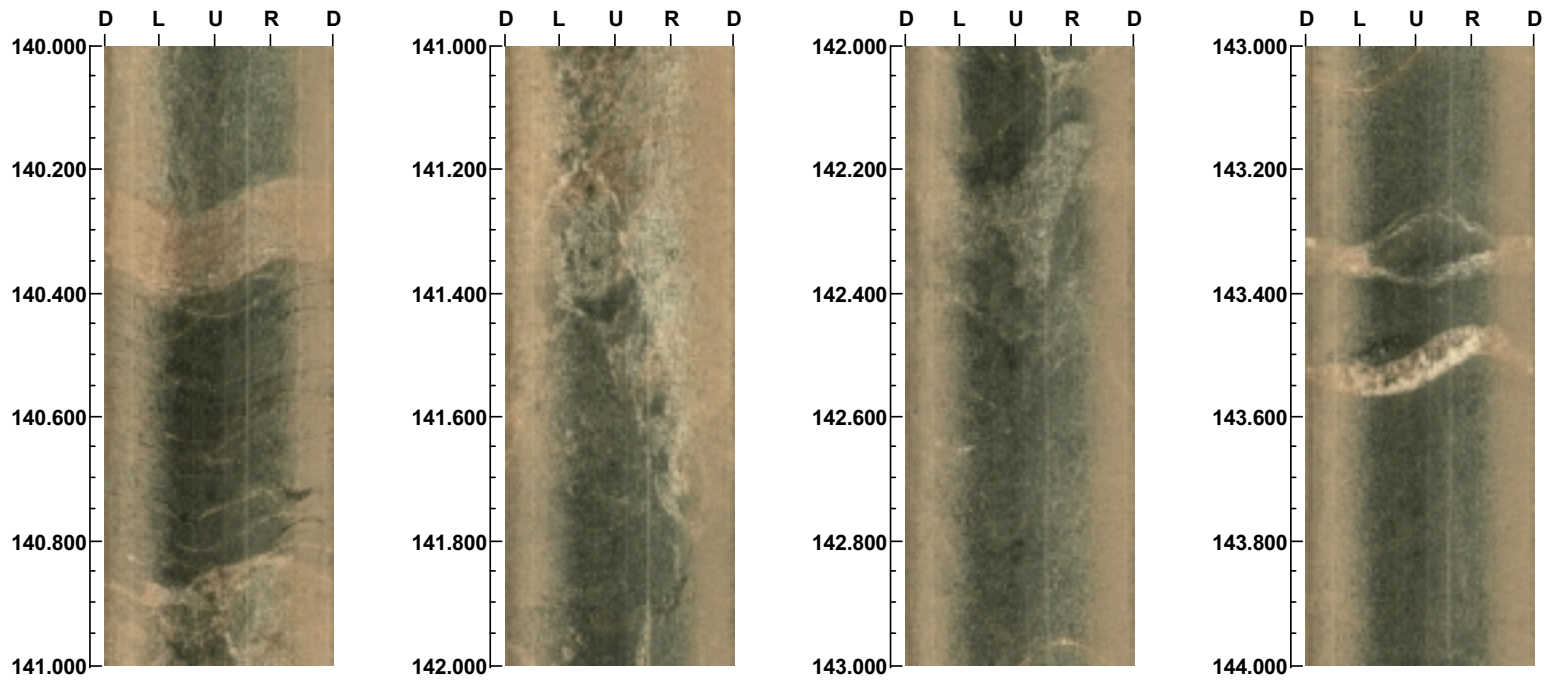

115

( 3 / 7 )

Scale: 1/10      Aspect ratio: 89 %

Project name: HSH01  
Bore hole No.: HSH01

Azimuth: 0      Inclination: -90

Depth range: 144.000 - 148.000 m

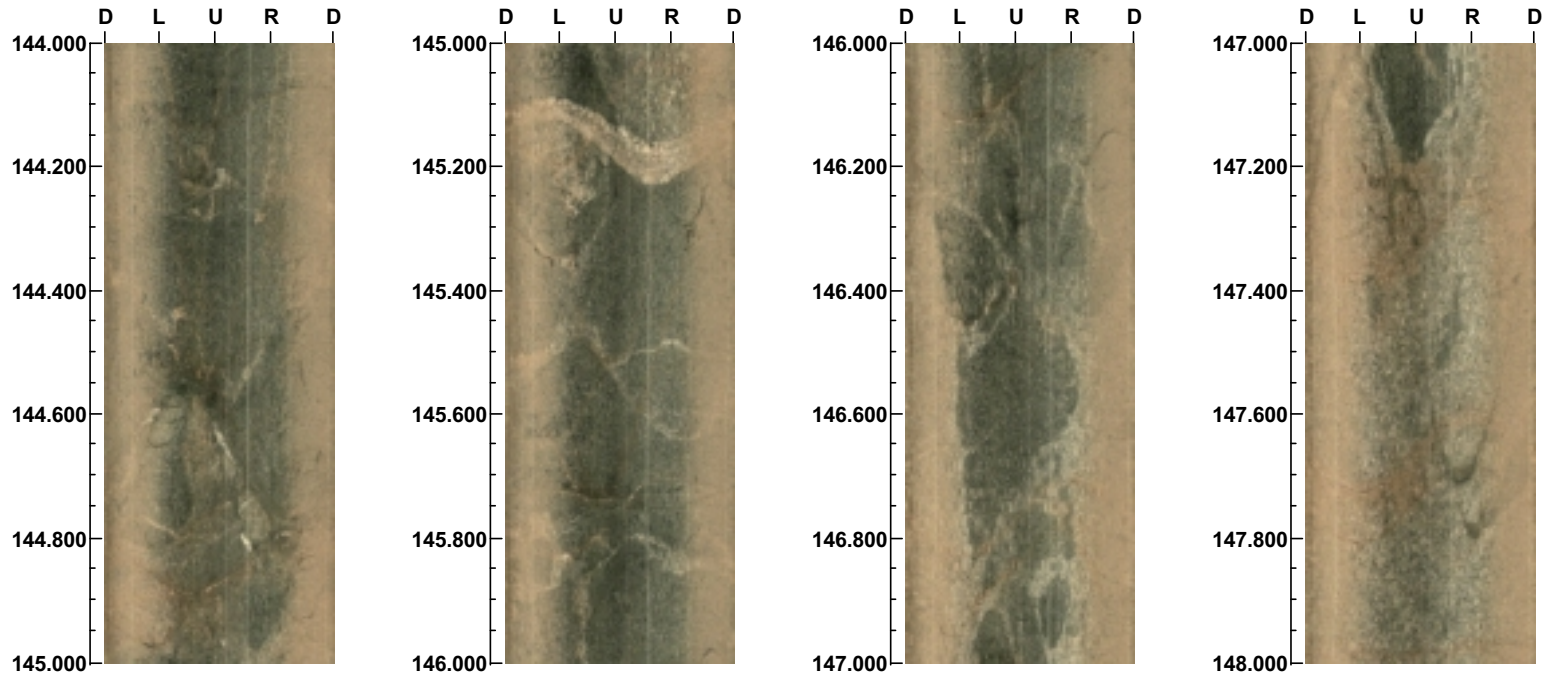



Project name: HSH01  
Bore hole No.: HSH01

Azimuth: 0      Inclination: -90

Depth range: 148.000 - 152.000 m

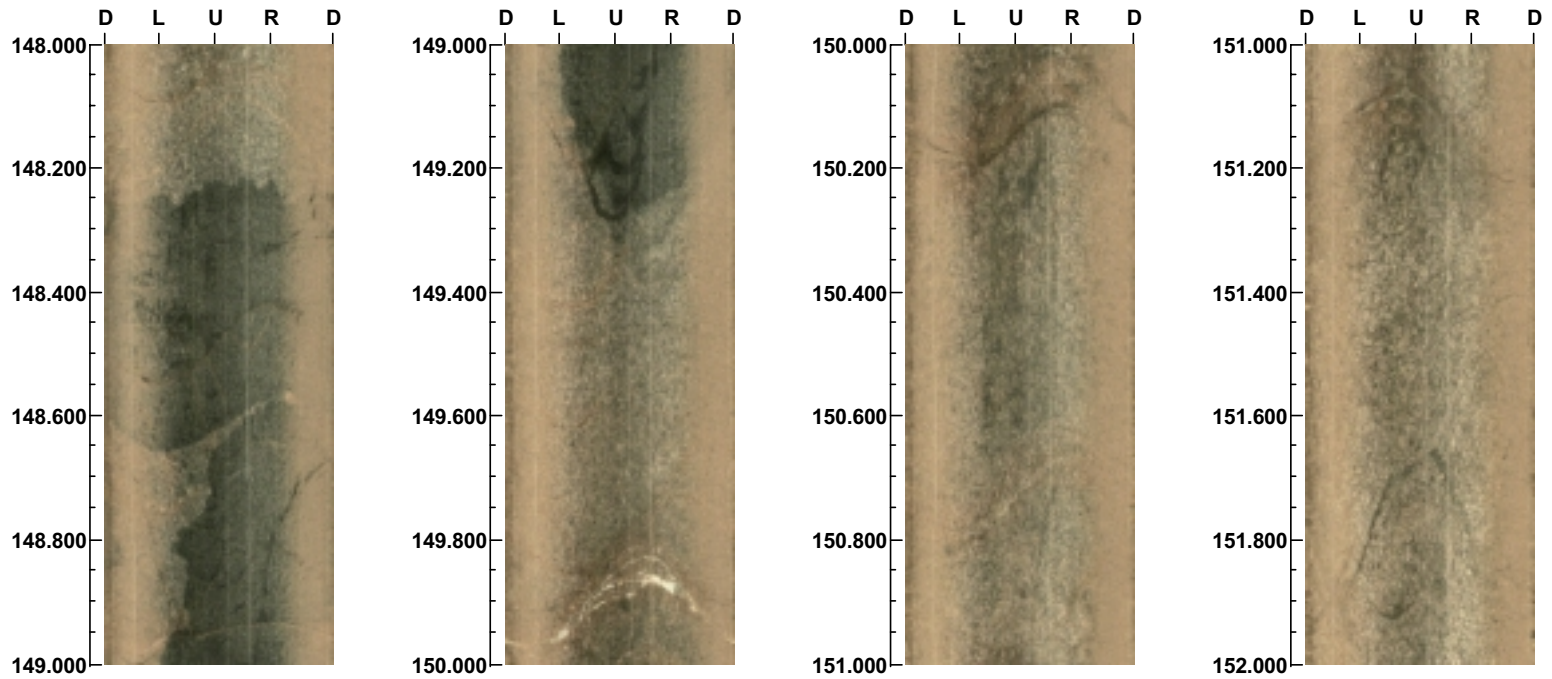

117

( 5 / 7 )

Scale: 1/10      Aspect ratio: 89 %



Project name: HSH01  
Bore hole No.: HSH01

Azimuth: 0      Inclination: -90

Depth range: 152.000 - 156.000 m

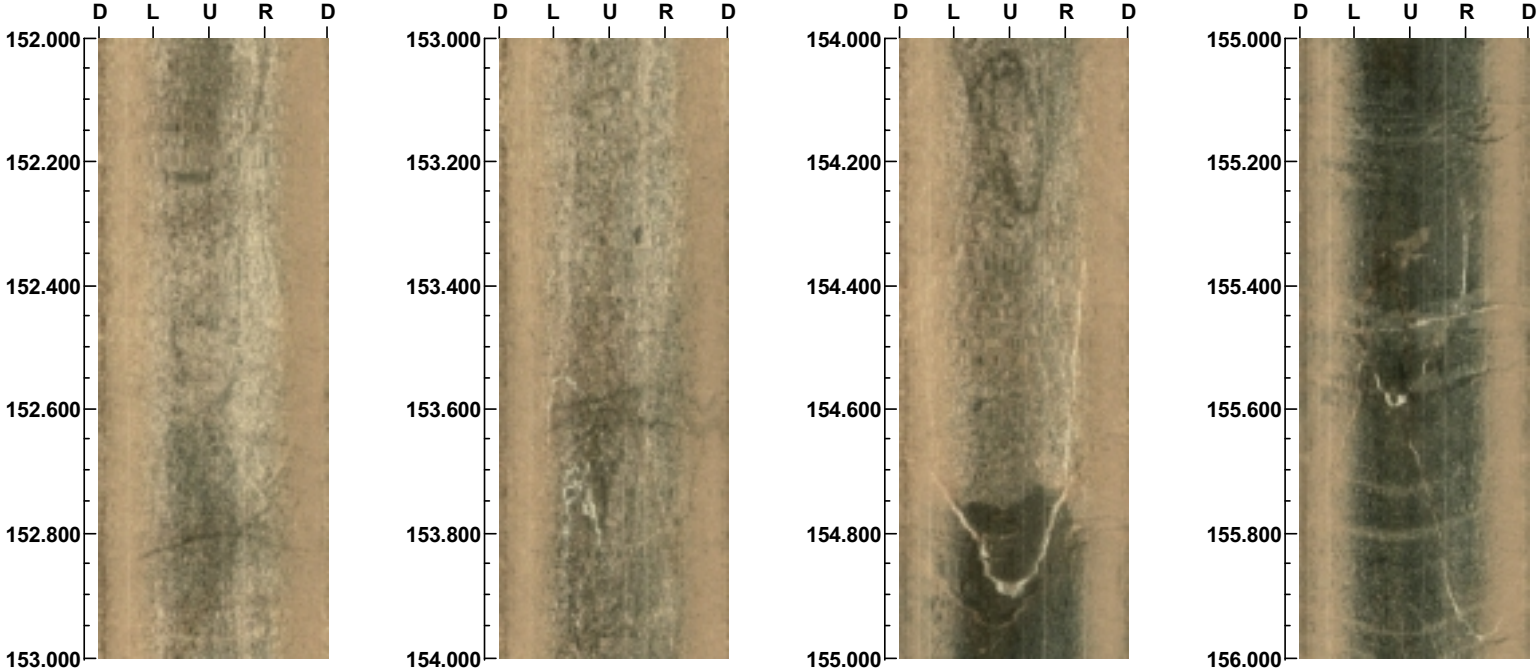

Project name: HSH01  
Bore hole No.: HSH01

Azimuth: 0      Inclination: -90

Depth range: 156.000 - 160.000 m

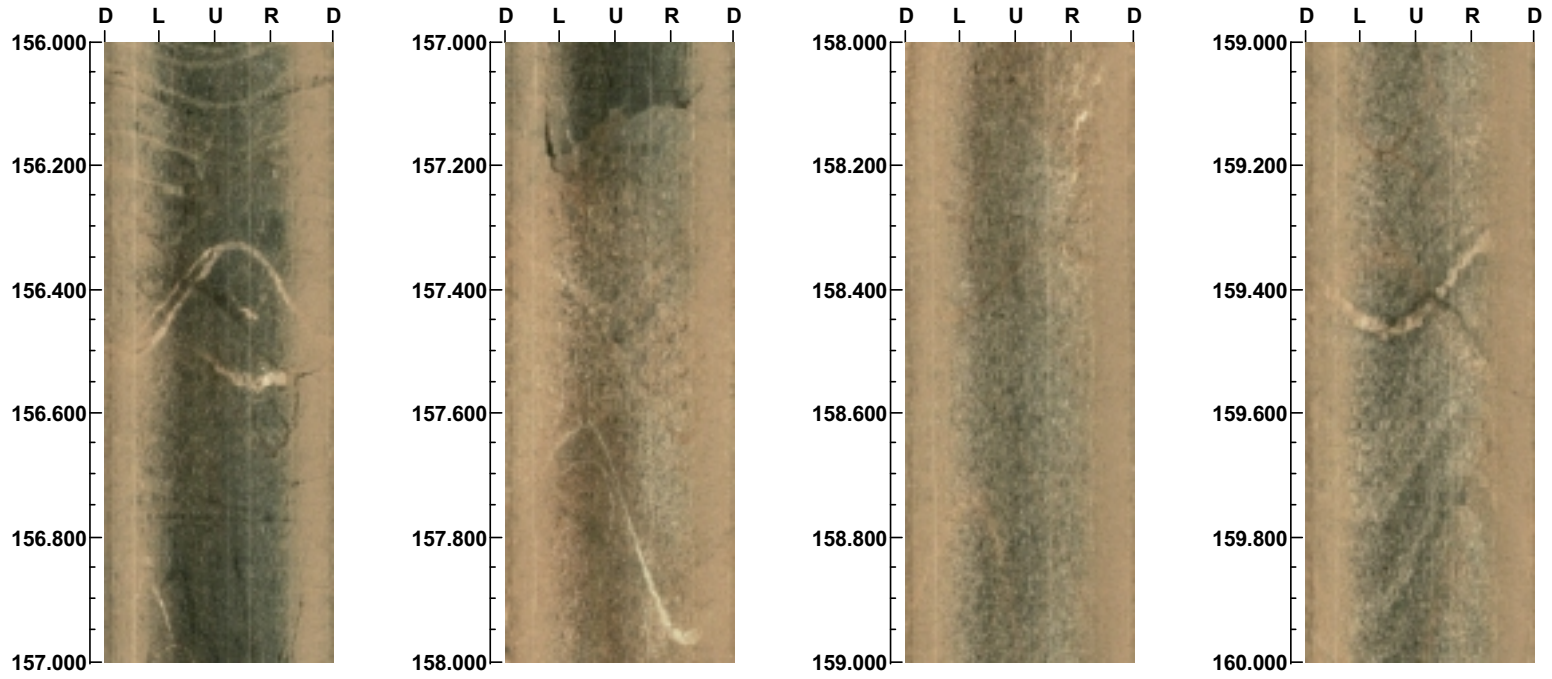

119

(7/7)

Scale: 1/10      Aspect ratio: 89 %

Project name: HSH01  
Bore hole No.: HSH01

Azimuth: 0      Inclination: -90

Depth range: 160.000 - 164.000 m

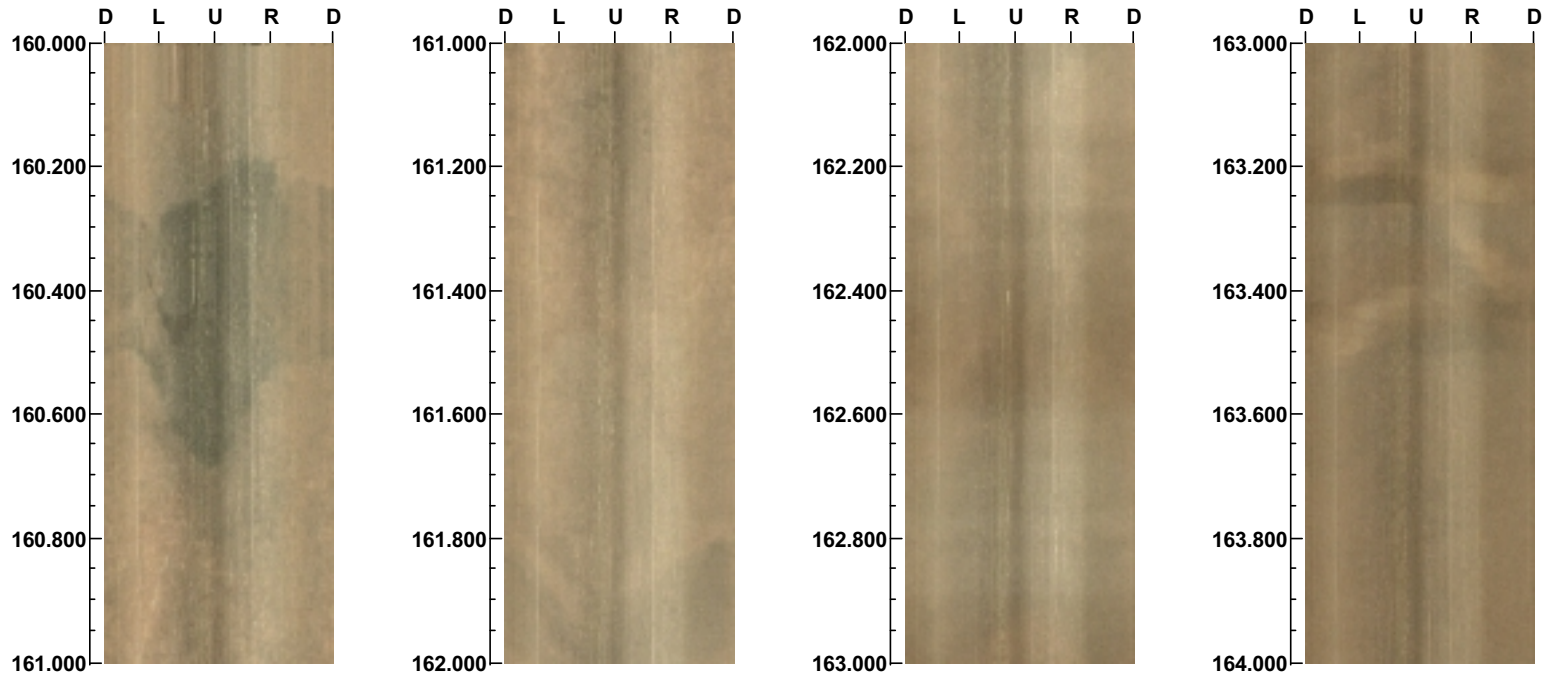

120

( 1 / 9 )

Scale: 1/10      Aspect ratio: 89 %

Project name: HSH01  
Bore hole No.: HSH01

Azimuth: 0      Inclination: -90

Depth range: 164.000 - 168.000 m

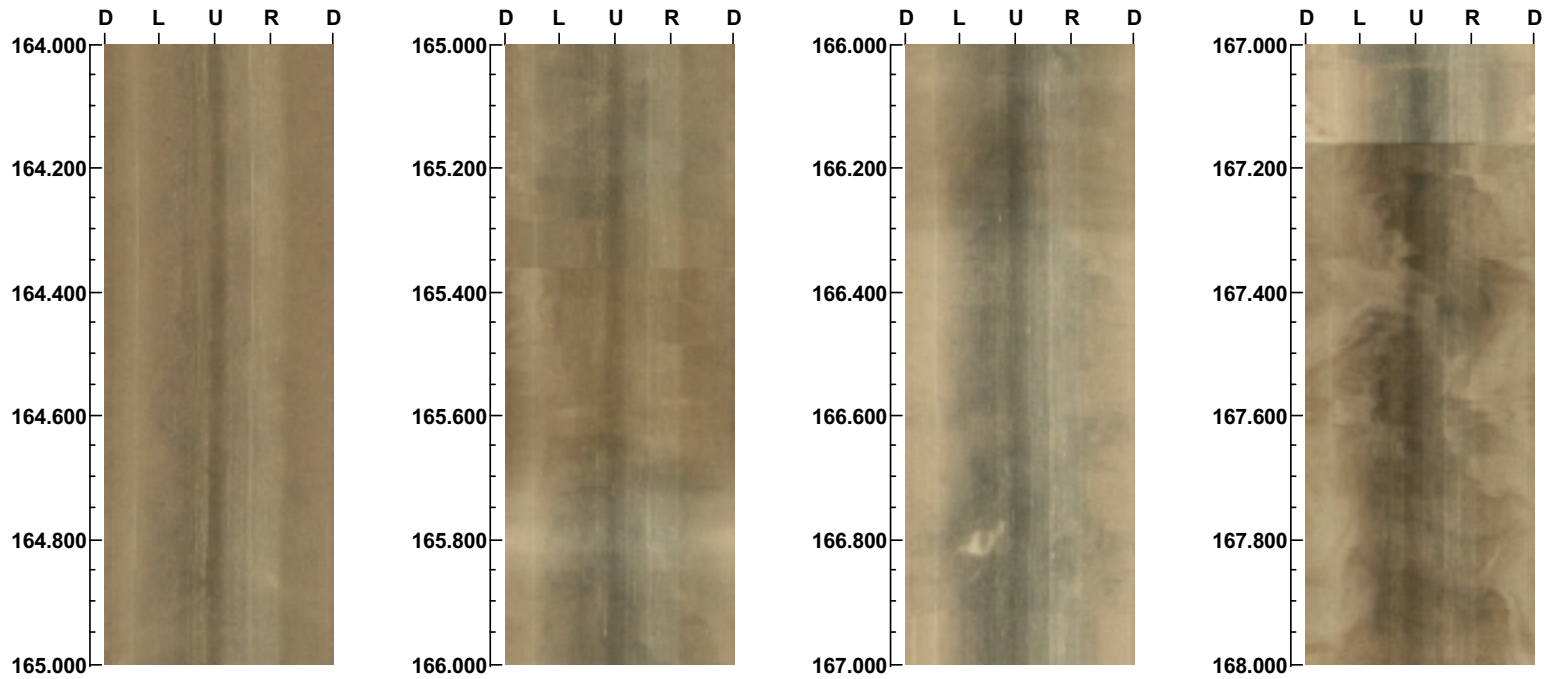

121

( 2 / 9 )

Scale: 1/10      Aspect ratio: 89 %

Project name: HSH01  
Bore hole No.: HSH01

Azimuth: 0      Inclination: -90

Depth range: 168.000 - 172.000 m

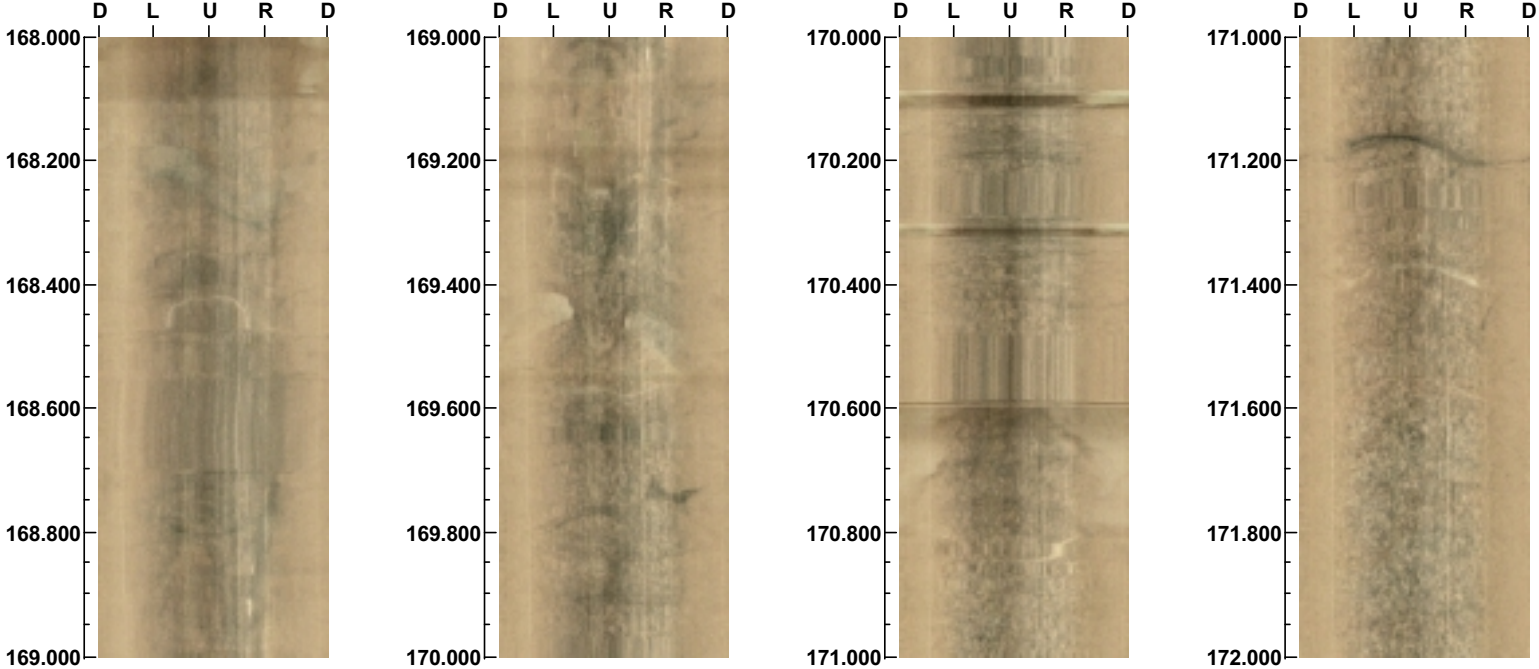

Project name: HSH01  
Bore hole No.: HSH01

Azimuth: 0      Inclination: -90

Depth range: 172.000 - 176.000 m

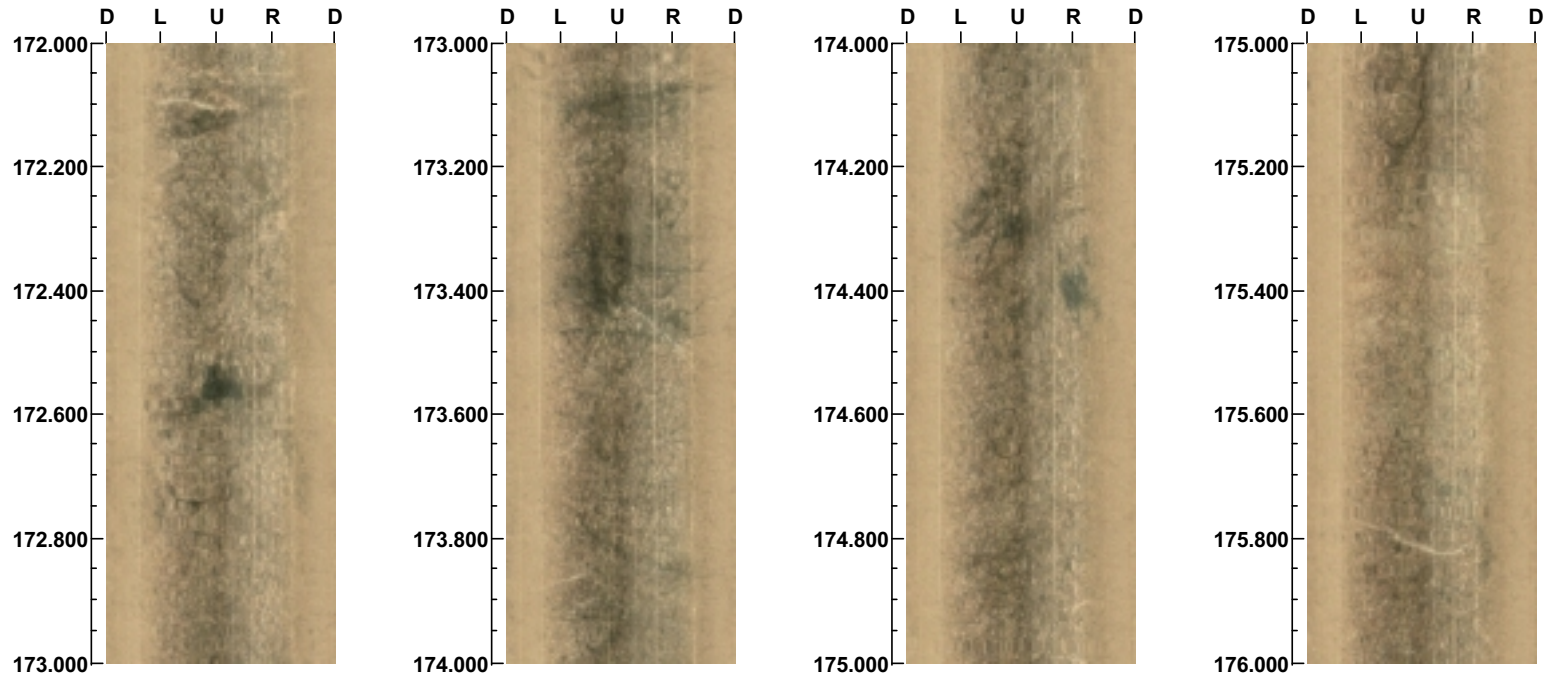

123

( 4 / 9 )

Scale: 1/10      Aspect ratio: 89 %



Project name: HSH01  
Bore hole No.: HSH01

Azimuth: 0      Inclination: -90

Depth range: 176.000 - 180.000 m

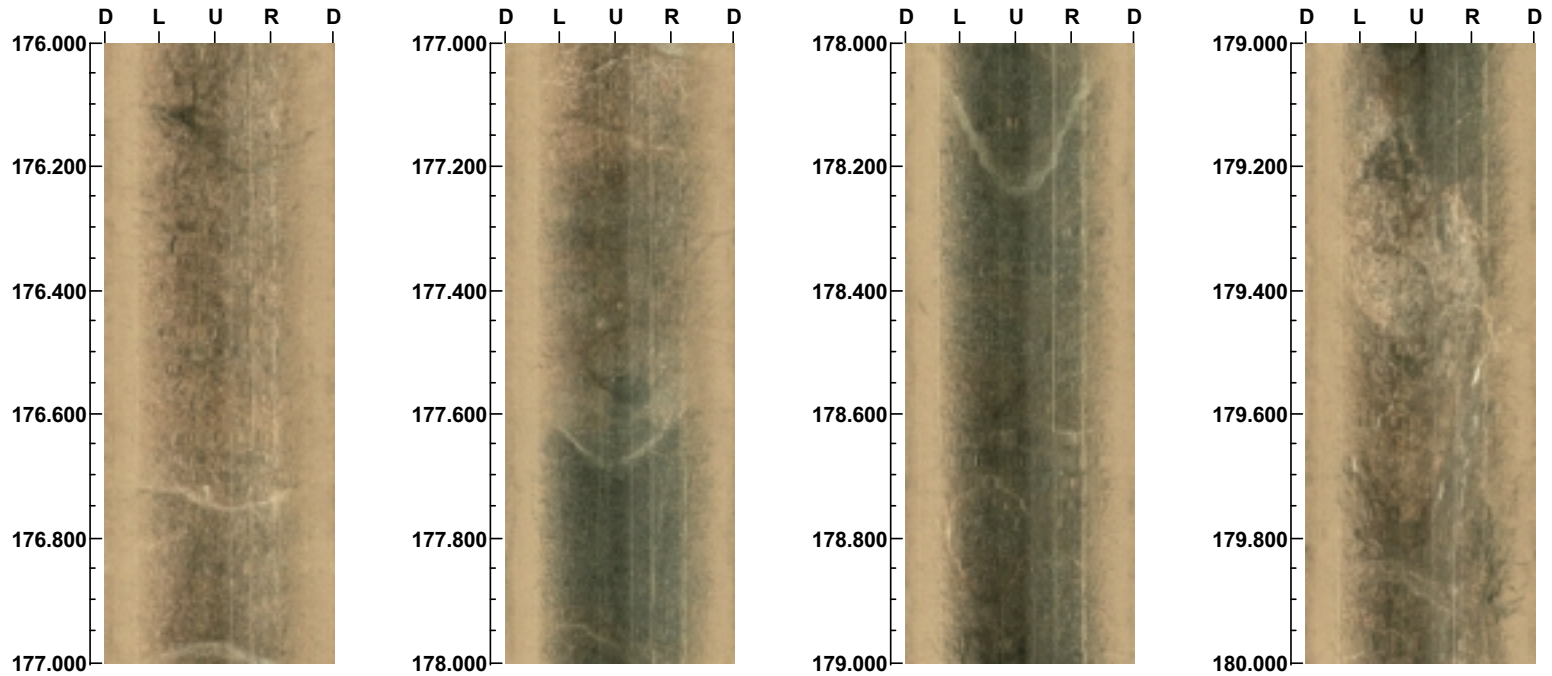



Project name: HSH01  
Bore hole No.: HSH01

Azimuth: 0      Inclination: -90

Depth range: 180.000 - 184.000 m

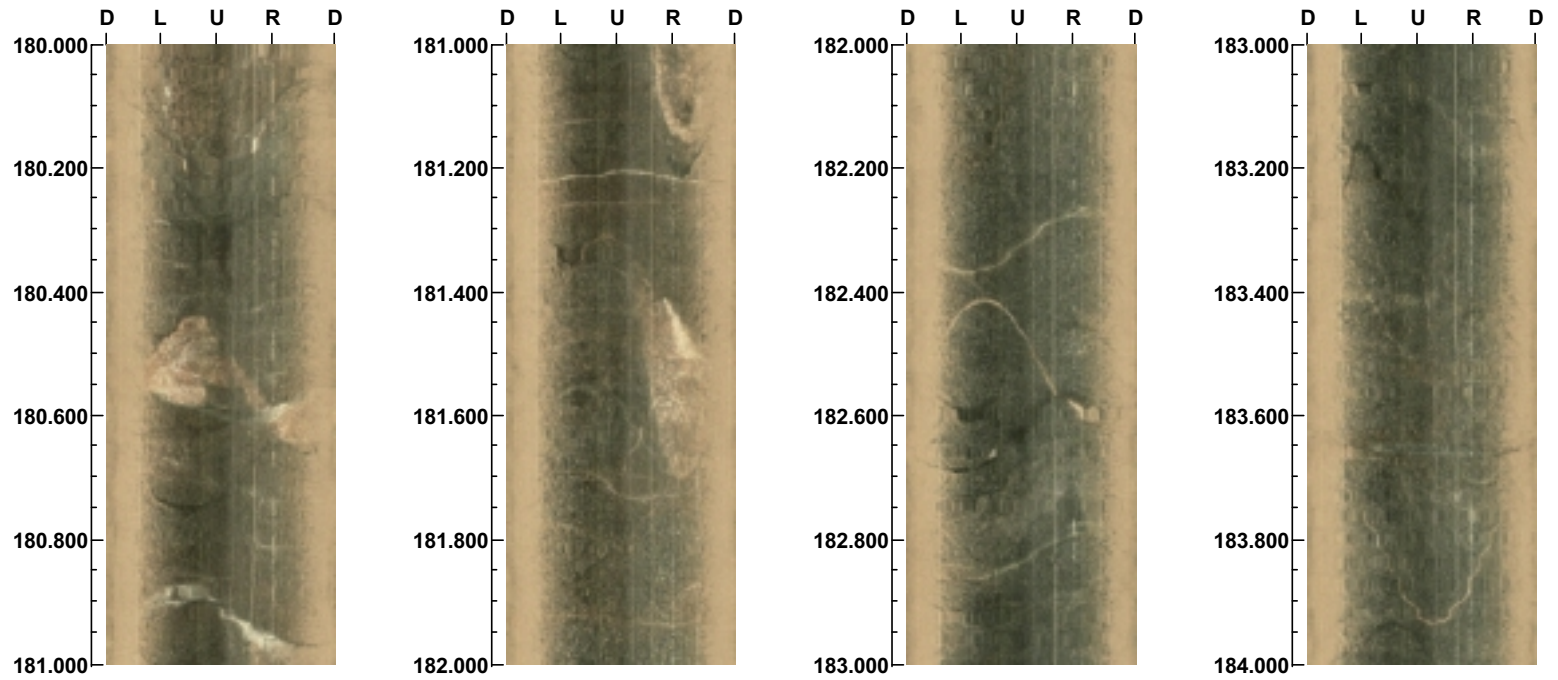

125

Project name: HSH01  
Bore hole No.: HSH01

Azimuth: 0      Inclination: -90

Depth range: 184.000 - 188.000 m

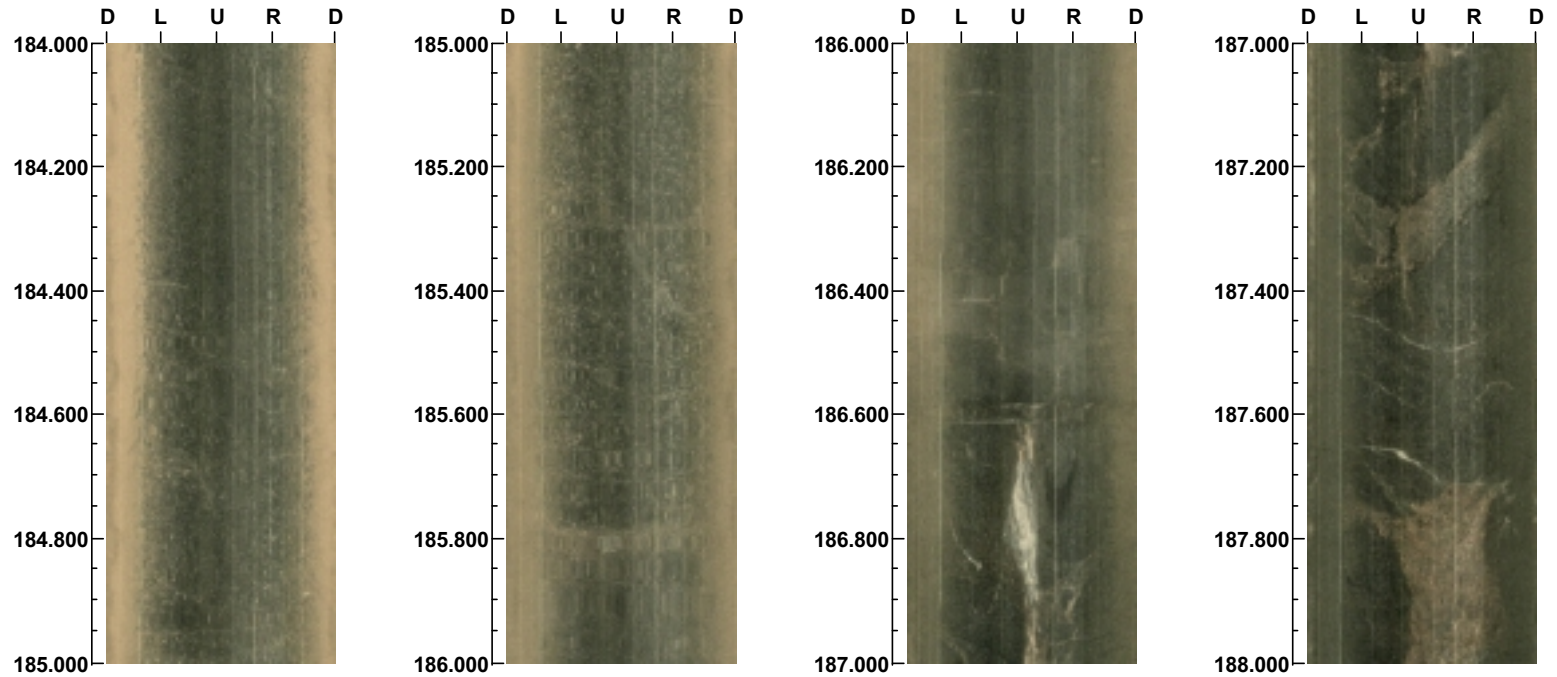

Project name: HSH01  
Bore hole No.: HSH01

Azimuth: 0      Inclination: -90

Depth range: 188.000 - 192.000 m

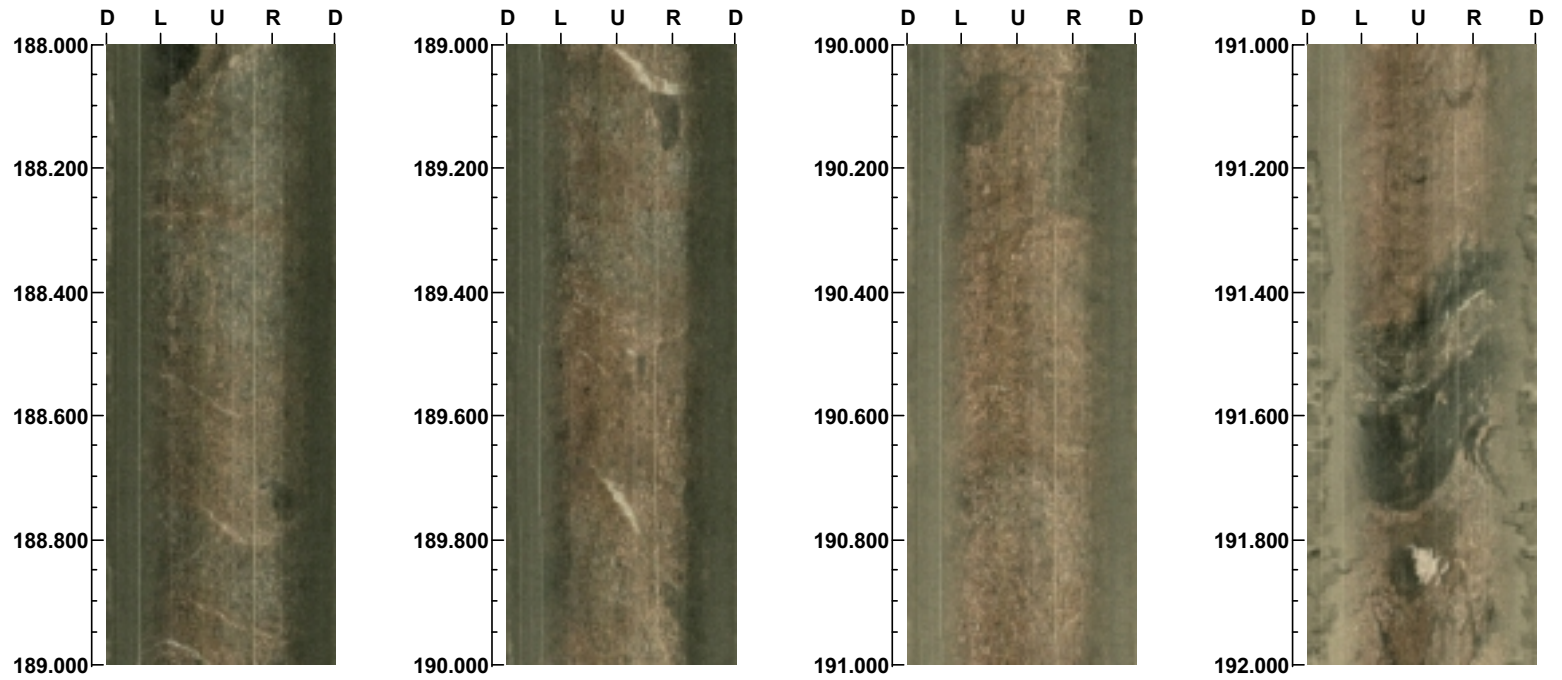

127

( 8 / 9 )

Scale: 1/10      Aspect ratio: 89 %

Project name: HSH01  
Bore hole No.: HSH01

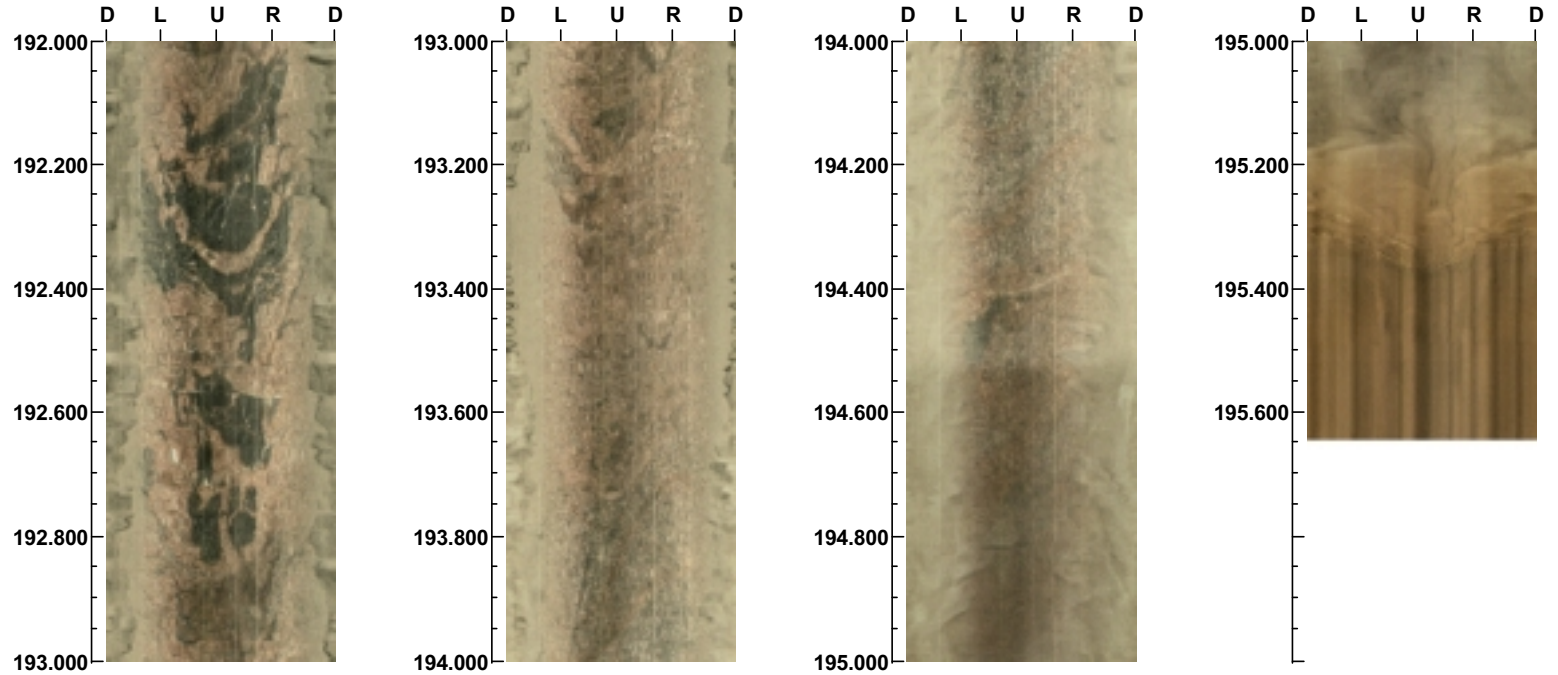

Azimuth: 0      Inclination: -90

Depth range: 192.000 - 195.641 m



**BIPS results from HSH02**

**Project name: HSH02**

**Image file** : c:\gurraw~1\oskars~1\bips\hsh02\000.bip  
**BDT file** :  
**Locality** : SIMPAN  
**Bore hole number** : HSH02  
**Date** : 02/09/16  
**Time** : 19:23:00  
**Depth range** : 11.000 - 179.993 m  
**Azimuth** : 0  
**Inclination** : -90  
**Diameter** : 132.0 mm  
**Magnetic declination** : 0.0  
**Span** : 4  
**Scan interval** : 0.25  
**Scan direction** : To bottom  
**Scale** : 1/10  
**Aspect ratio** : 89 %  
**Pages** : 43  
**Color** :     
                  +0           +0           +0

Project name: HSH02  
Bore hole No.: HSH02

Azimuth: 0      Inclination: -90

Depth range: 11.000 - 15.000 m

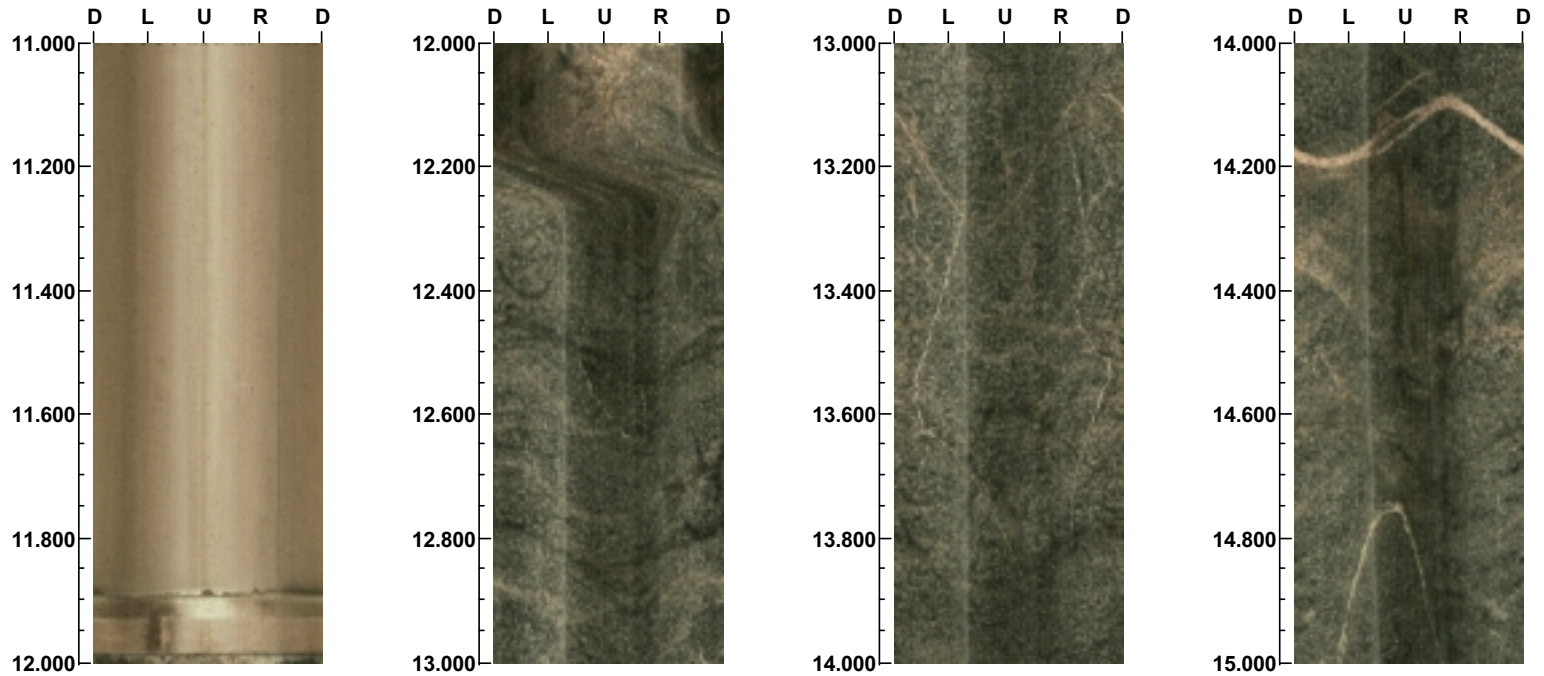

130

( 1 / 43 )

Scale: 1/10      Aspect ratio: 89 %



Project name: HSH02  
Bore hole No.: HSH02

Azimuth: 0      Inclination: -90

Depth range: 15.000 - 19.000 m

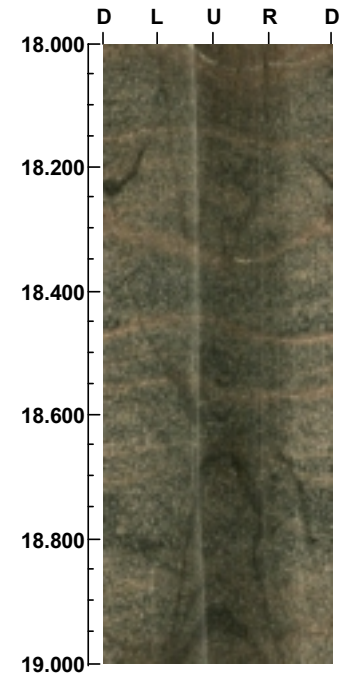
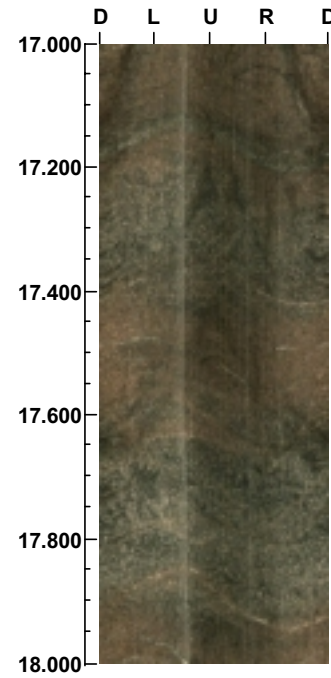
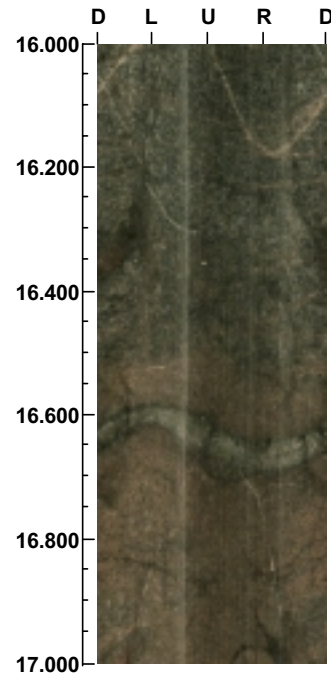
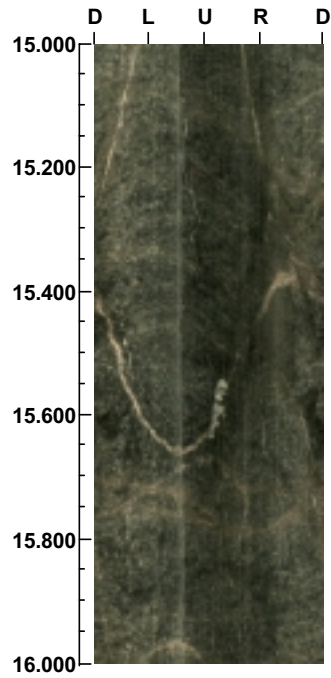



Project name: HSH02  
Bore hole No.: HSH02

Azimuth: 0      Inclination: -90

Depth range: 19.000 - 23.000 m

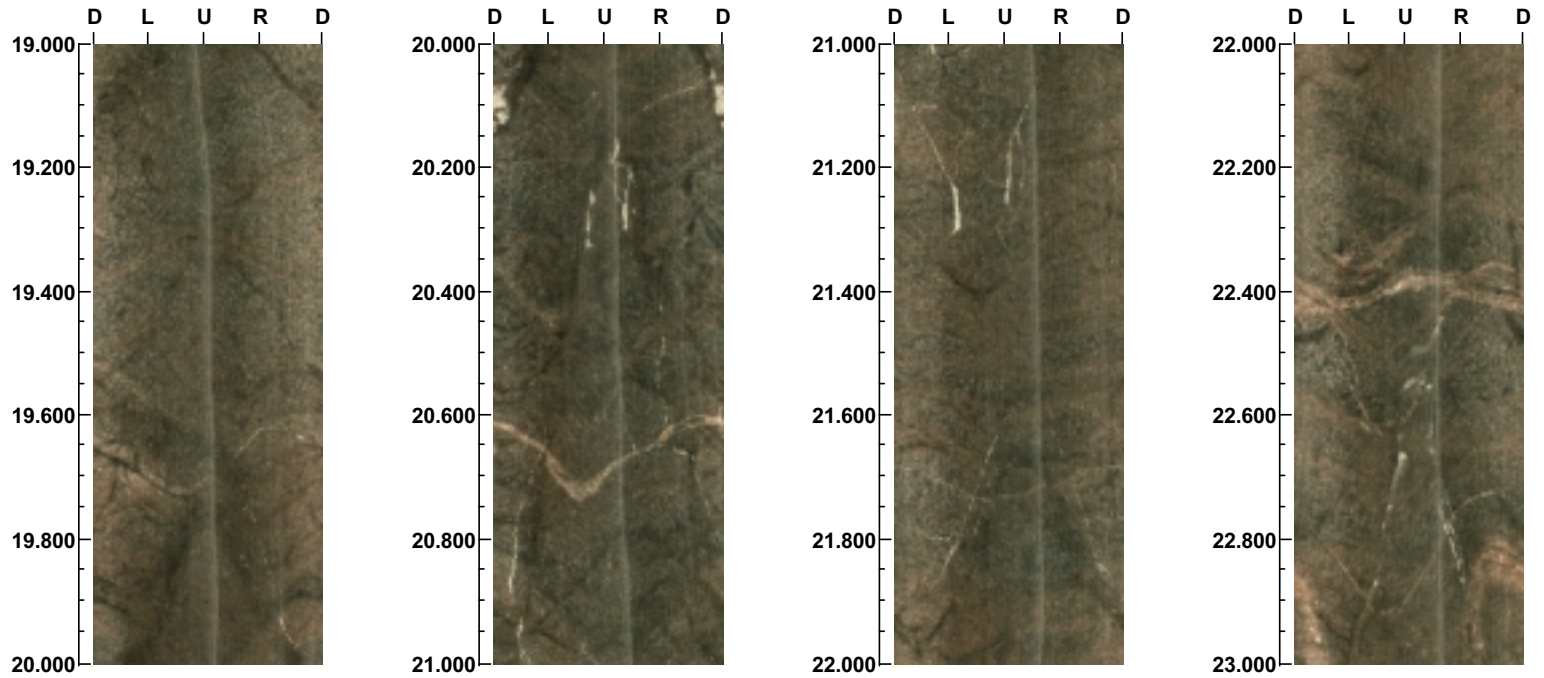

Project name: HSH02  
Bore hole No.: HSH02

Azimuth: 0      Inclination: -90

Depth range: 23.000 - 27.000 m

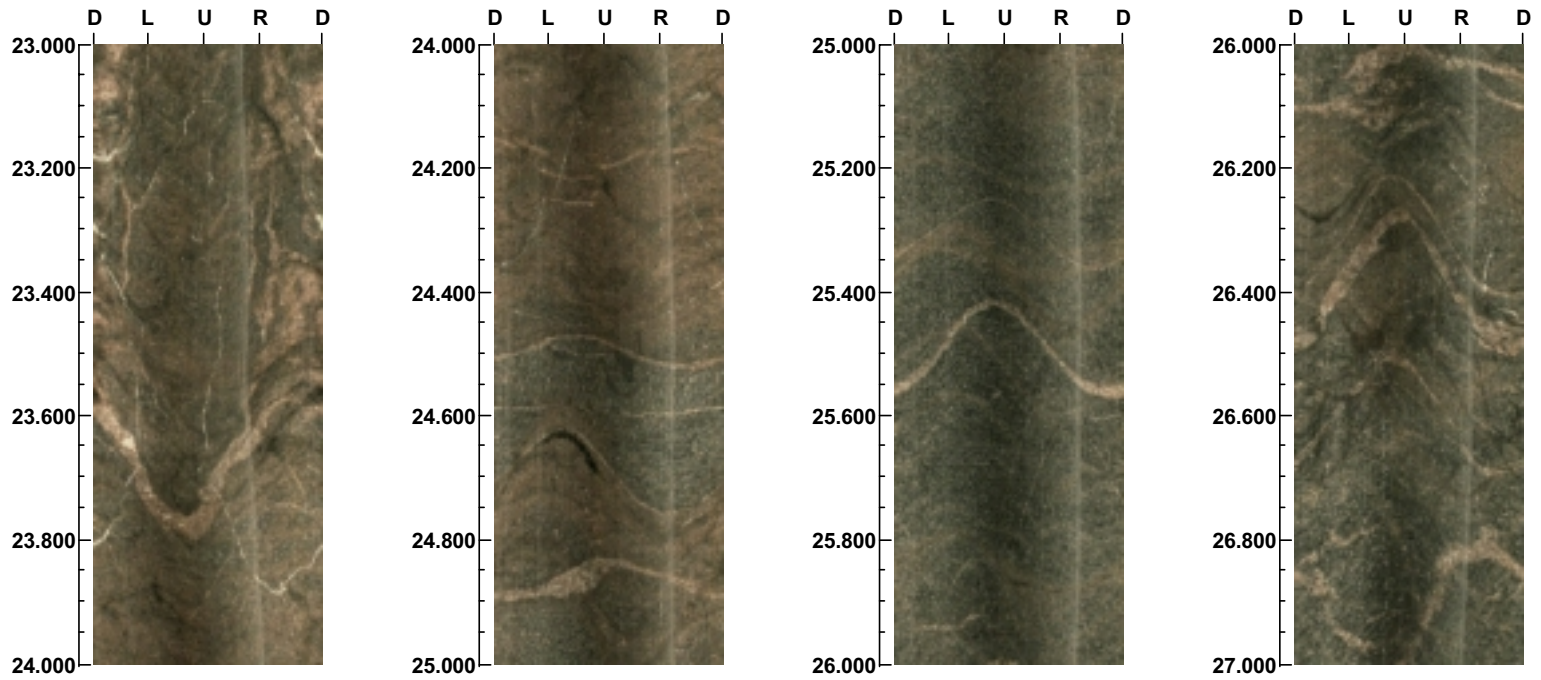

Project name: HSH02  
Bore hole No.: HSH02

Azimuth: 0      Inclination: -90

Depth range: 27.000 - 31.000 m

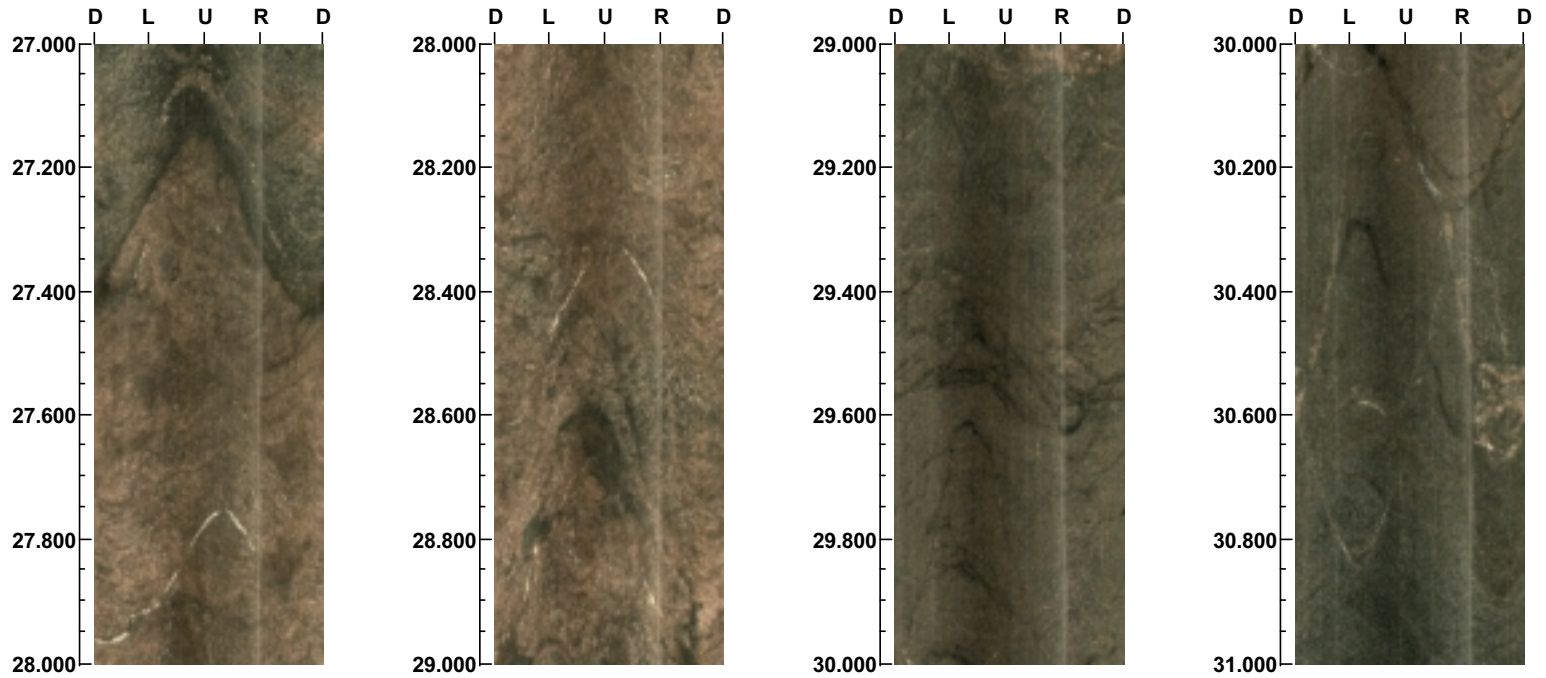

Project name: HSH02  
Bore hole No.: HSH02

Azimuth: 0      Inclination: -90

Depth range: 31.000 - 35.000 m

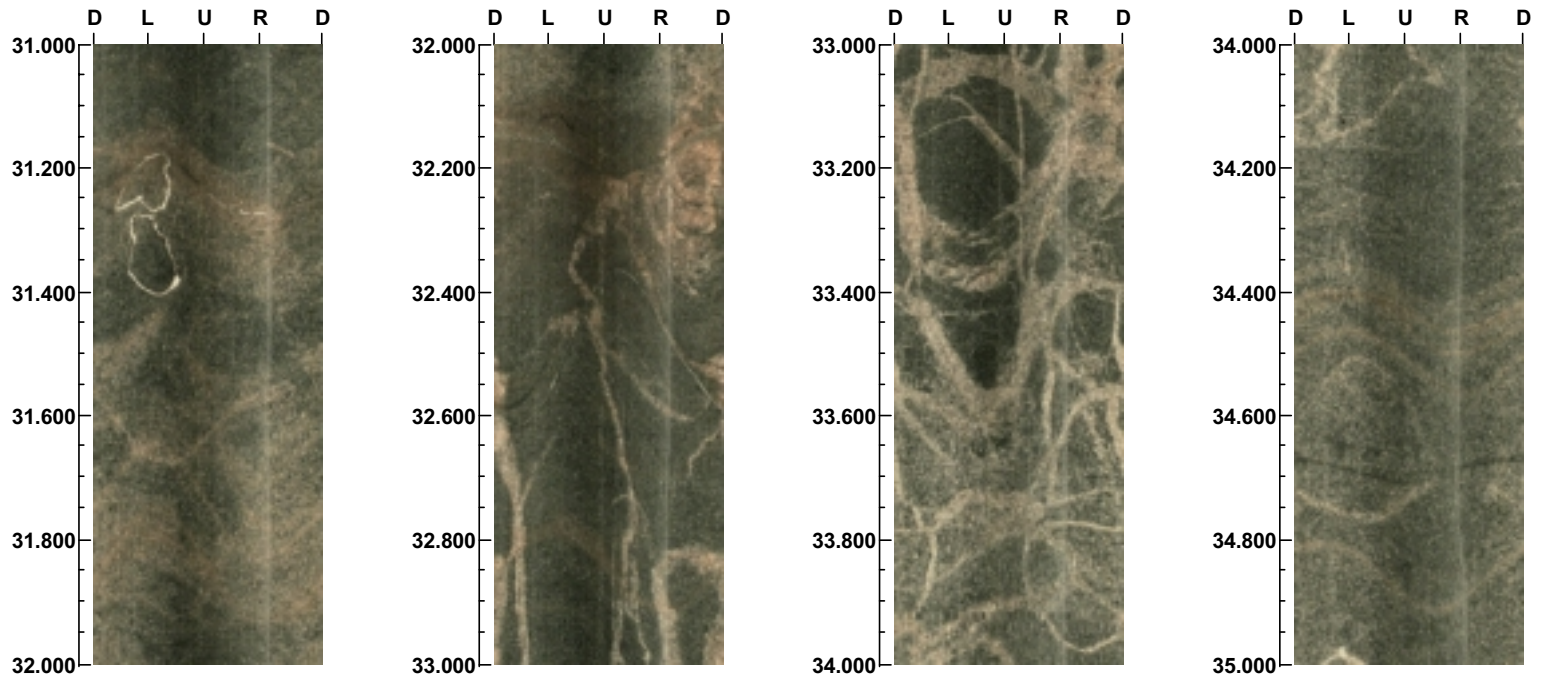

Project name: HSH02  
Bore hole No.: HSH02

Azimuth: 0      Inclination: -90

Depth range: 35.000 - 39.000 m

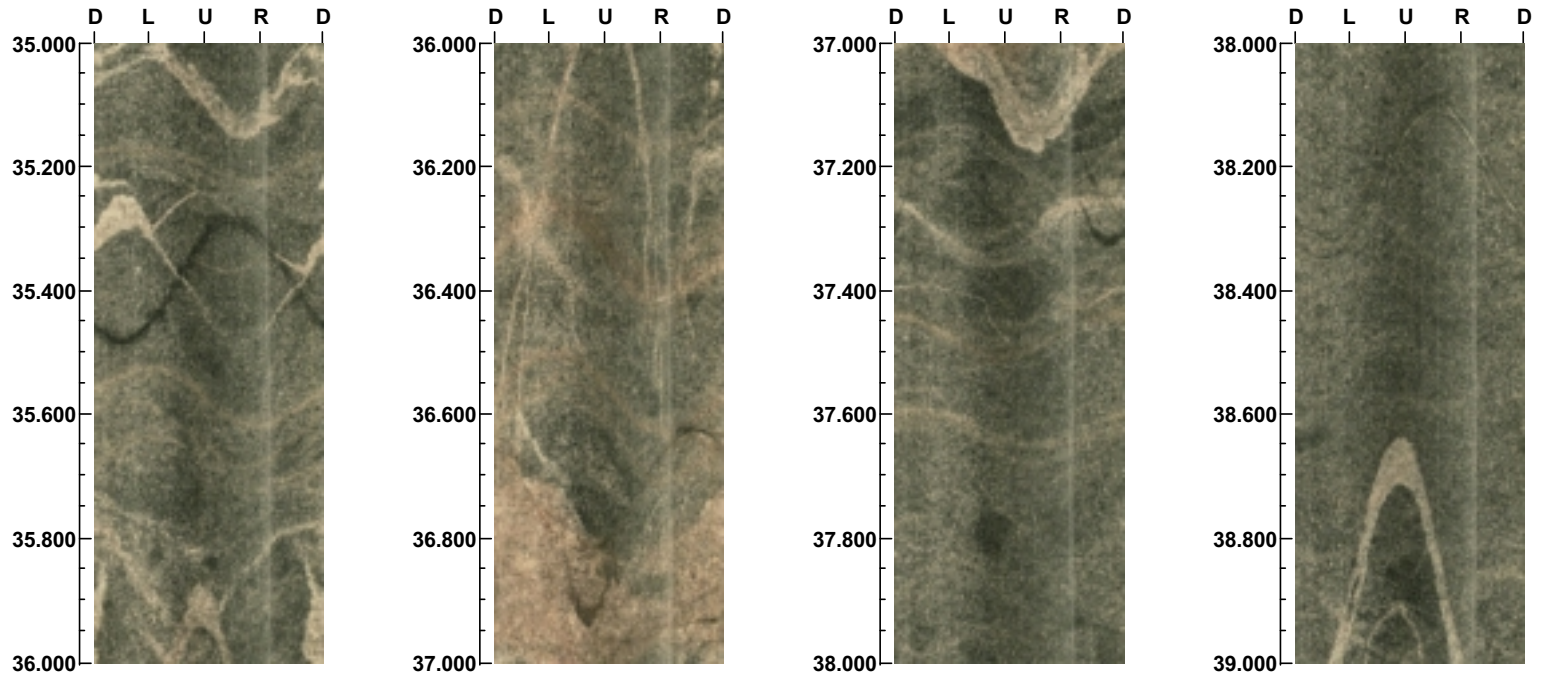



Project name: HSH02  
Bore hole No.: HSH02

Azimuth: 0      Inclination: -90

Depth range: 39.000 - 43.000 m

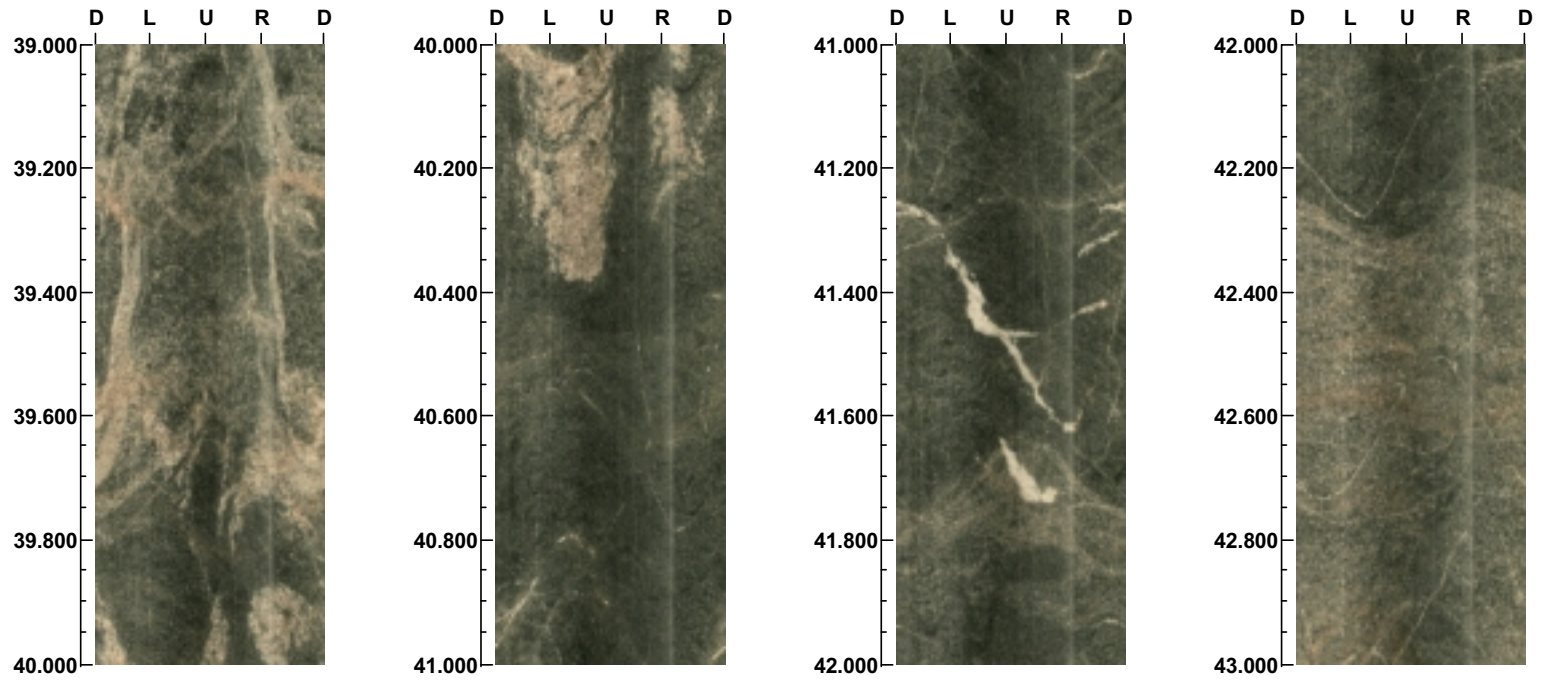

137

Project name: HSH02  
Bore hole No.: HSH02

Azimuth: 0      Inclination: -90

Depth range: 43.000 - 47.000 m

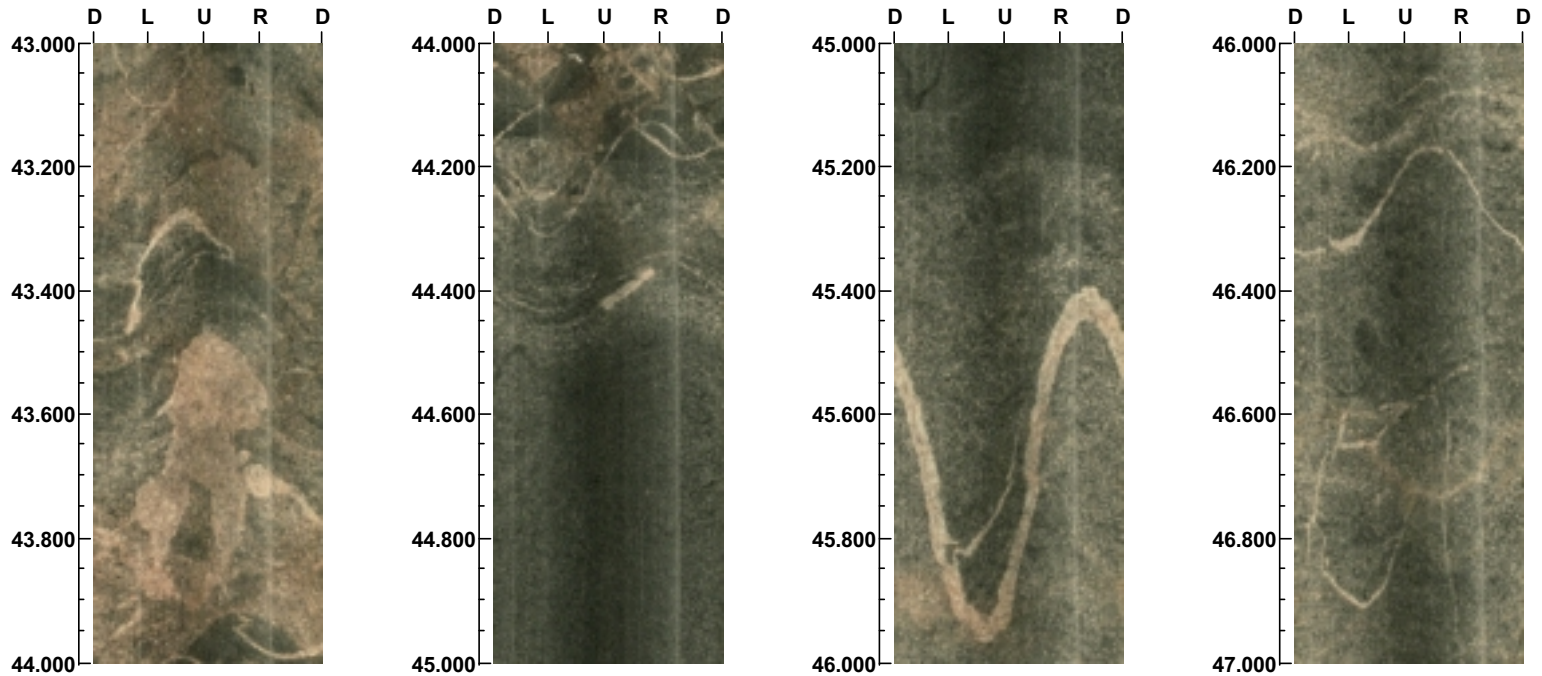



Project name: HSH02  
Bore hole No.: HSH02

Azimuth: 0      Inclination: -90

Depth range: 47.000 - 51.000 m

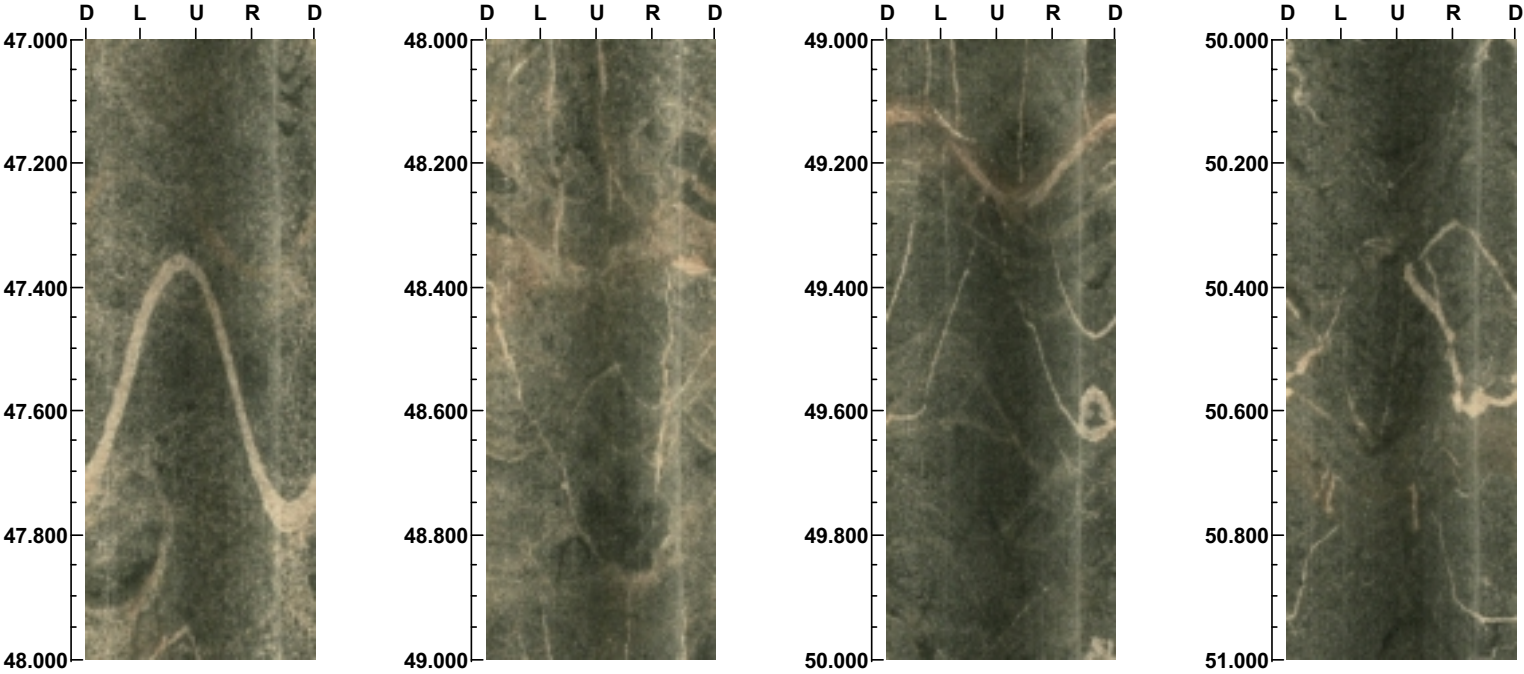

Project name: HSH02  
Bore hole No.: HSH02

Azimuth: 0      Inclination: -90

Depth range: 51.000 - 55.000 m

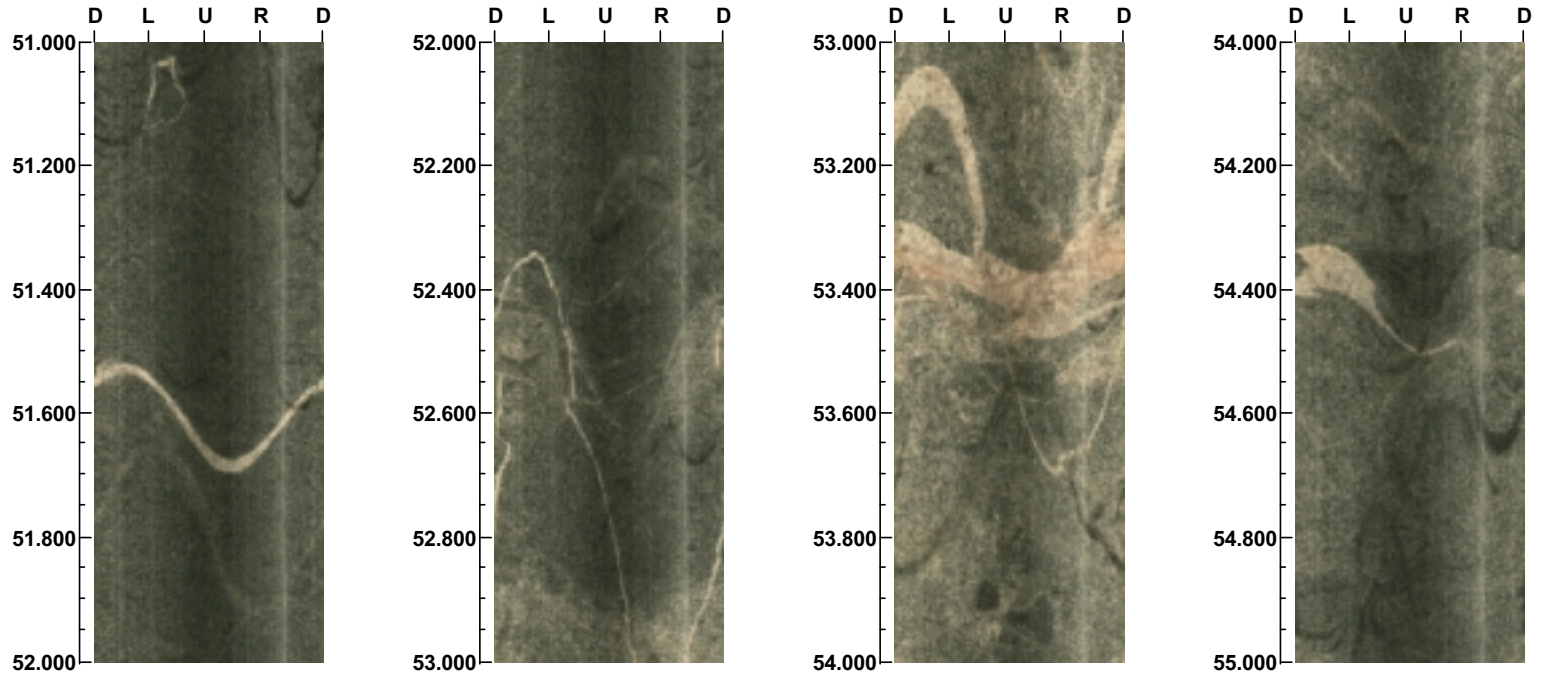

140

Project name: HSH02  
Bore hole No.: HSH02

Azimuth: 0      Inclination: -90

Depth range: 55.000 - 59.000 m

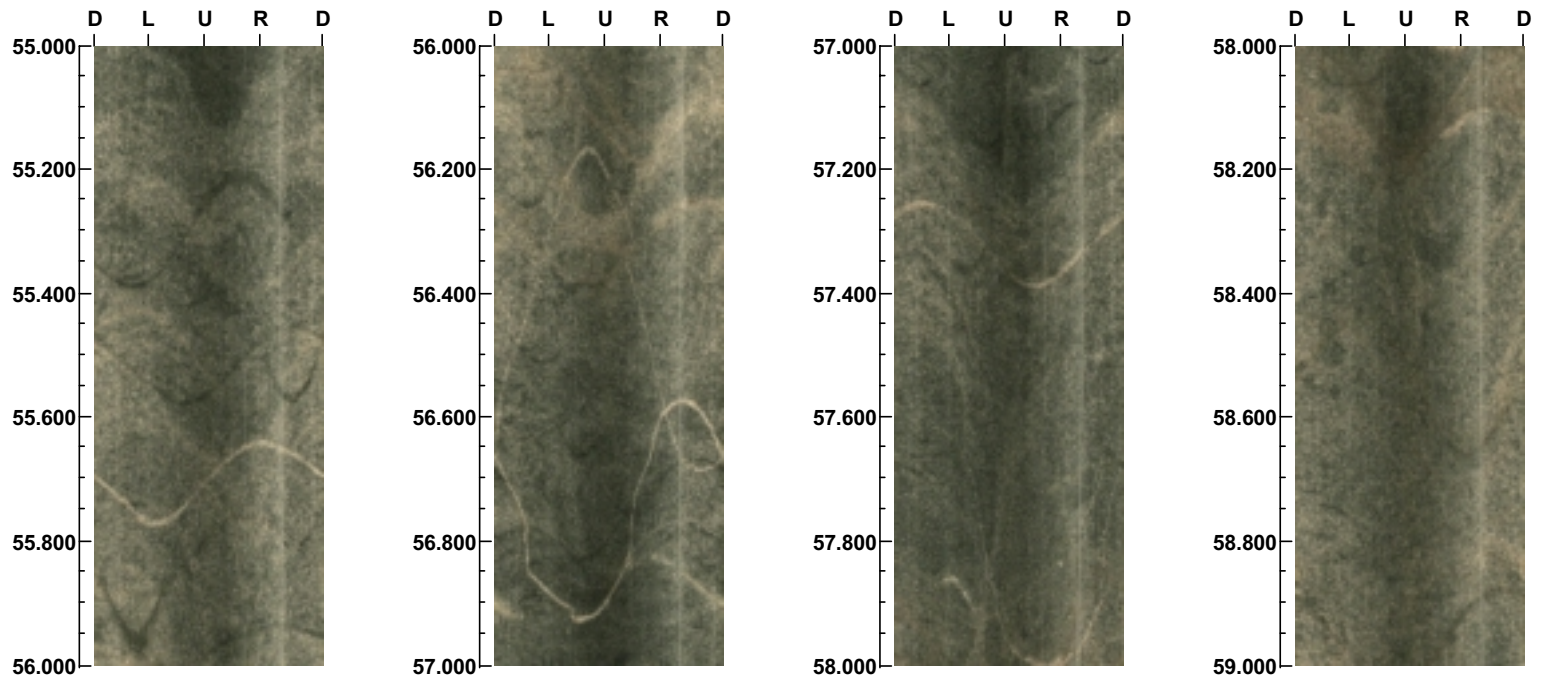

Project name: HSH02  
Bore hole No.: HSH02

Azimuth: 0      Inclination: -90

Depth range: 59.000 - 63.000 m

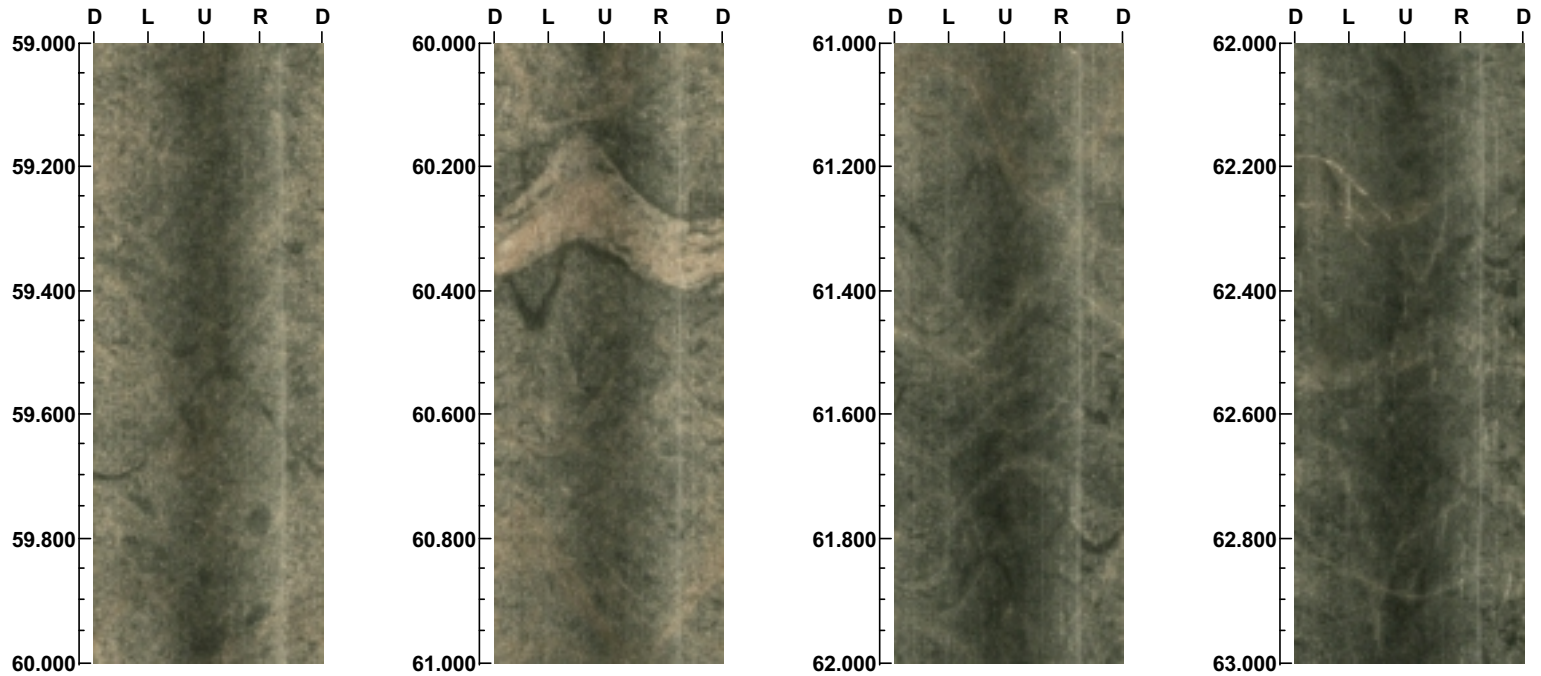

142

Project name: HSH02  
Bore hole No.: HSH02

Azimuth: 0      Inclination: -90

Depth range: 63.000 - 67.000 m

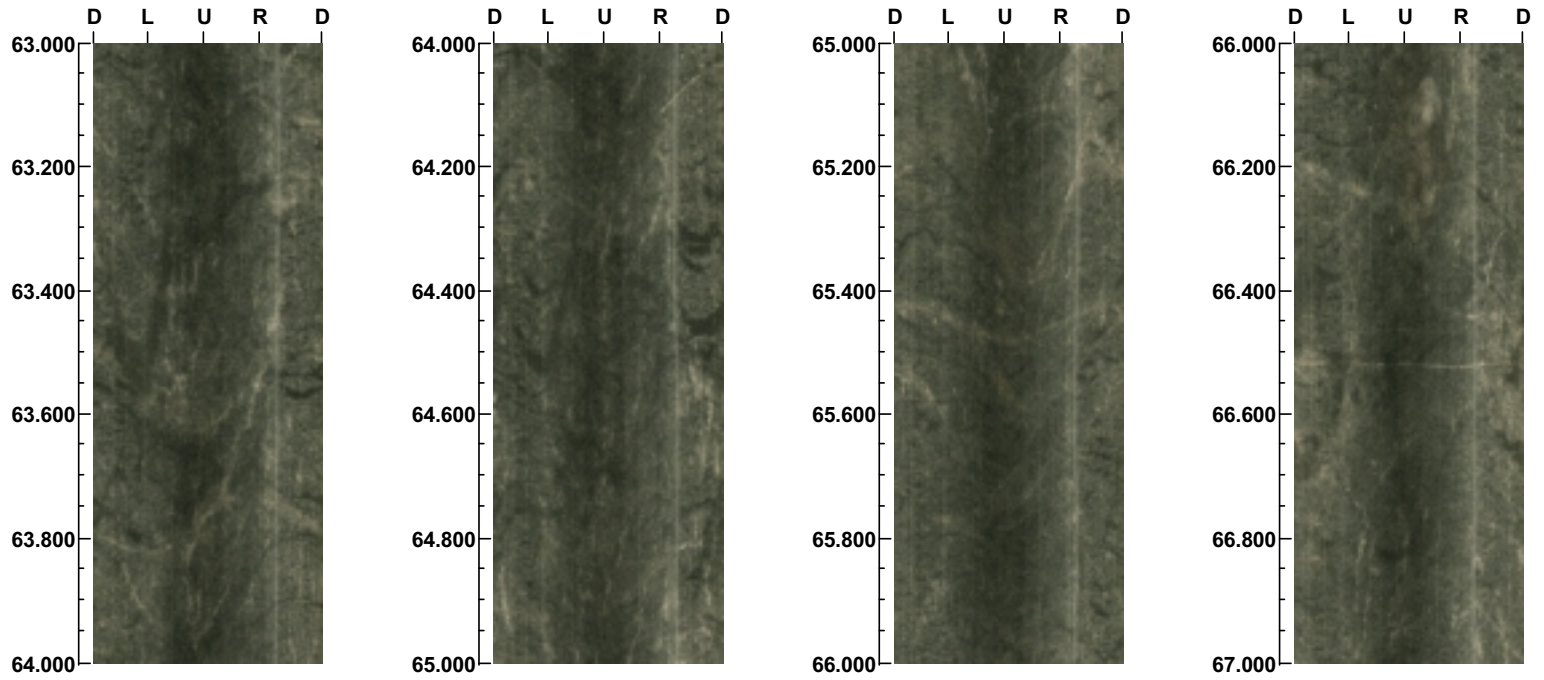



Project name: HSH02  
Bore hole No.: HSH02

Azimuth: 0      Inclination: -90

Depth range: 67.000 - 71.000 m

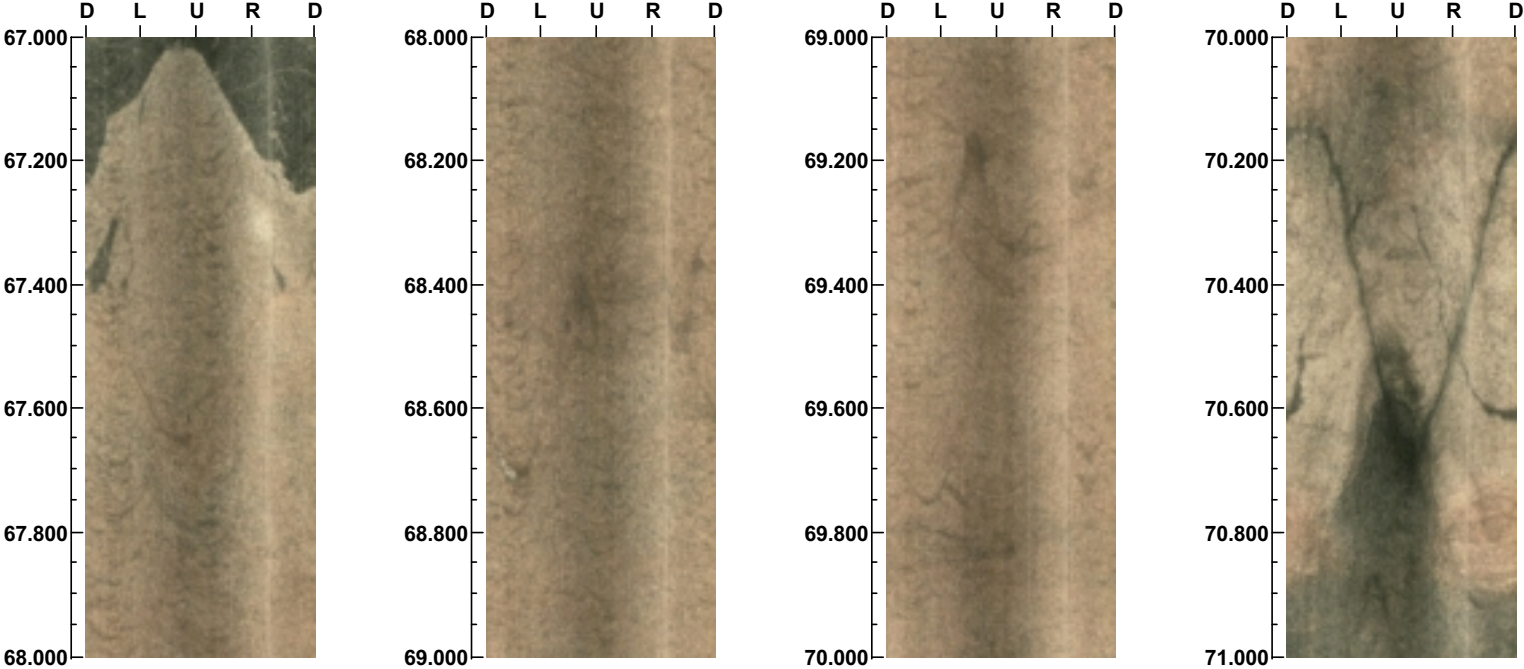

144

Project name: HSH02  
Bore hole No.: HSH02

Azimuth: 0      Inclination: -90

Depth range: 71.000 - 75.000 m

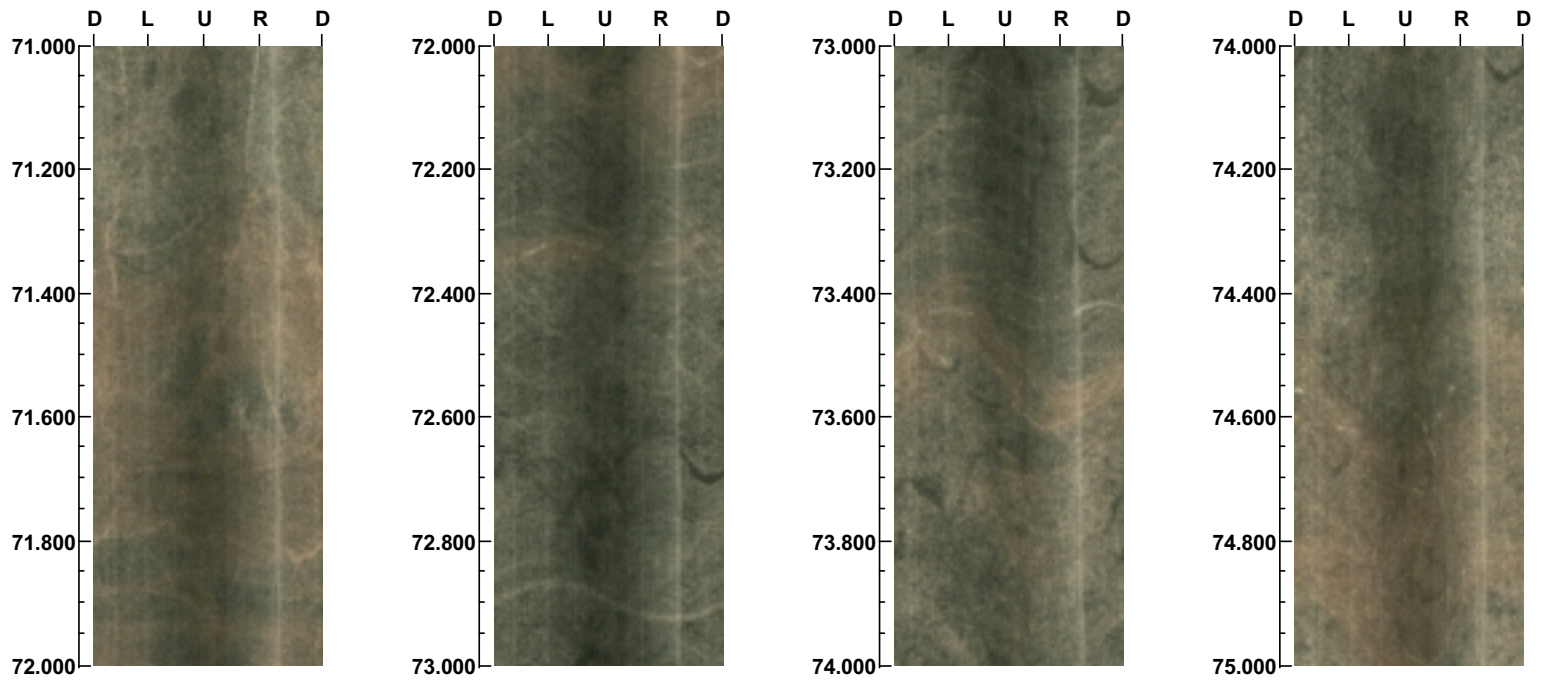

145



Project name: HSH02  
Bore hole No.: HSH02

Azimuth: 0      Inclination: -90

Depth range: 75.000 - 79.000 m

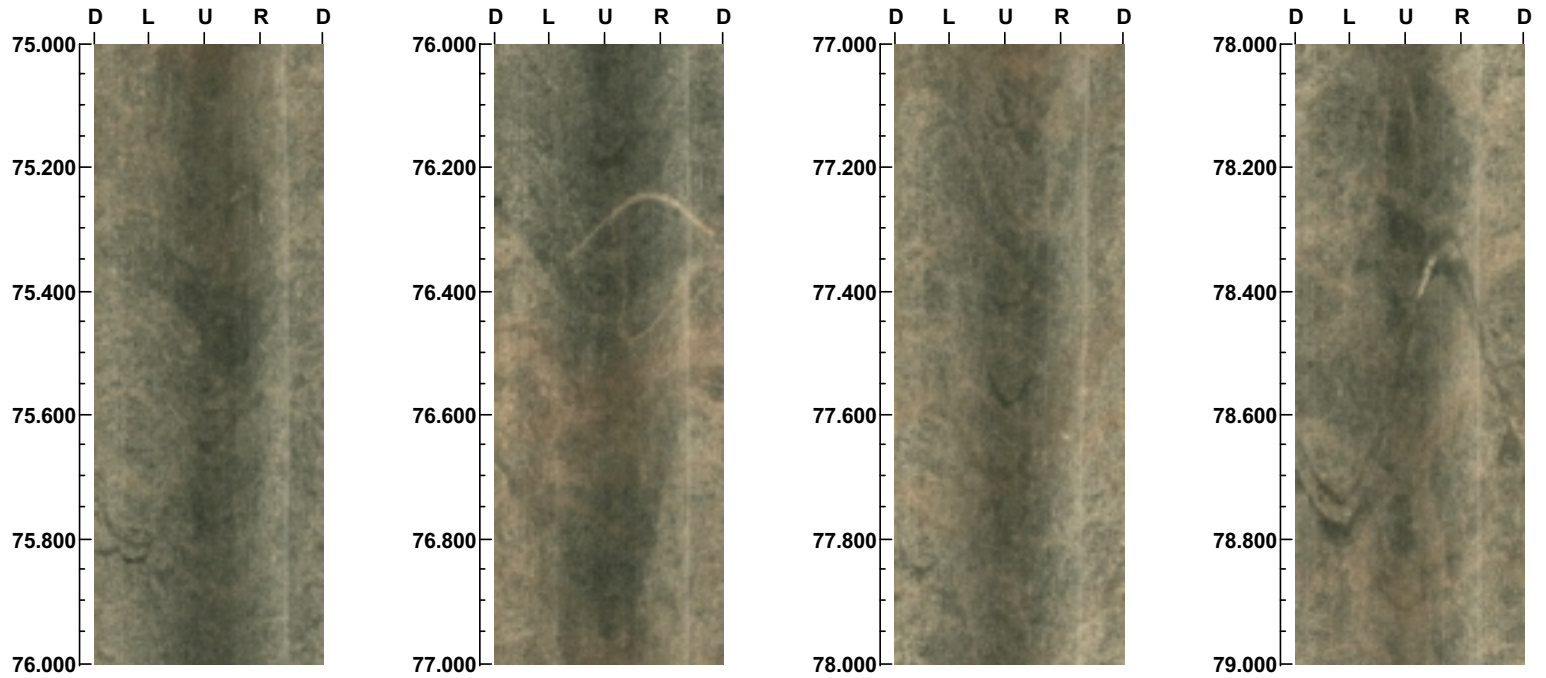

Project name: HSH02  
Bore hole No.: HSH02

Azimuth: 0      Inclination: -90

Depth range: 79.000 - 83.000 m

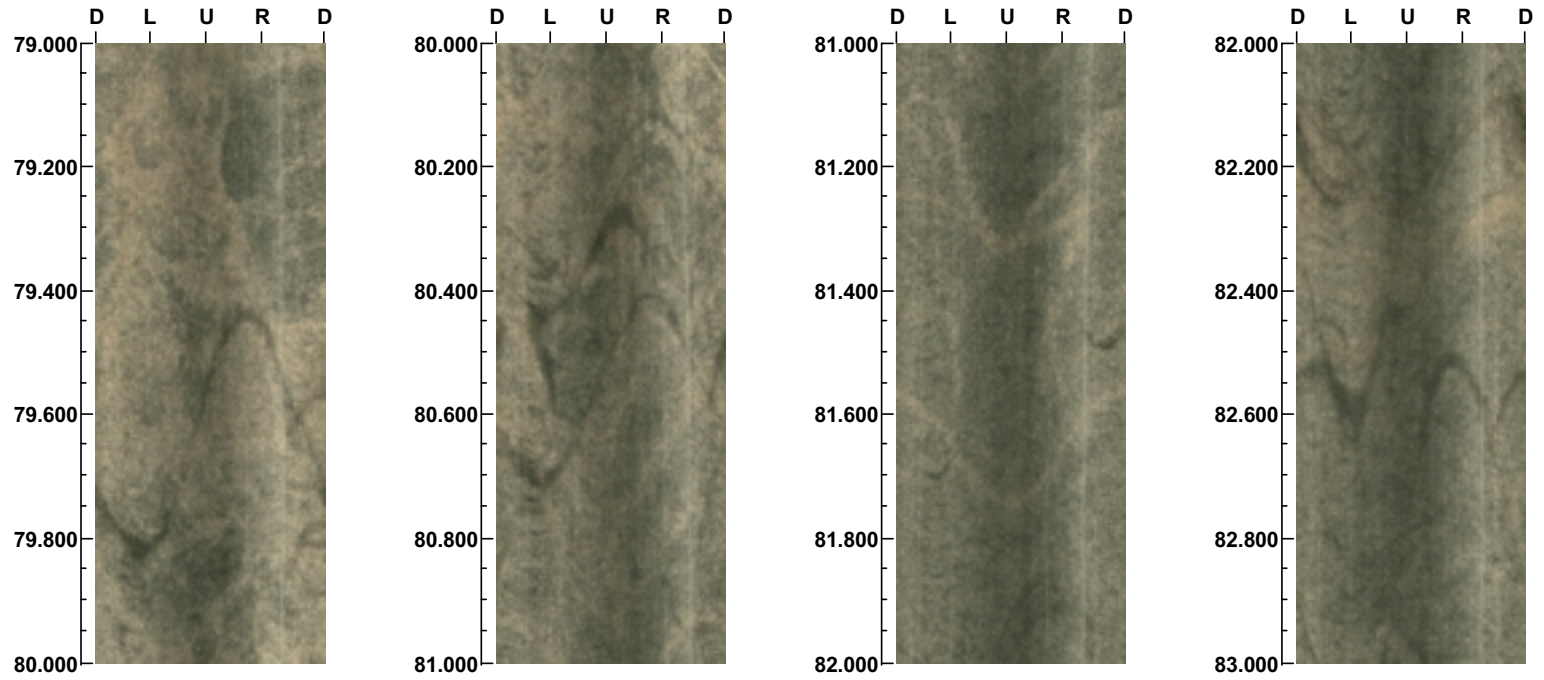

Project name: HSH02  
Bore hole No.: HSH02

Azimuth: 0      Inclination: -90

Depth range: 83.000 - 87.000 m

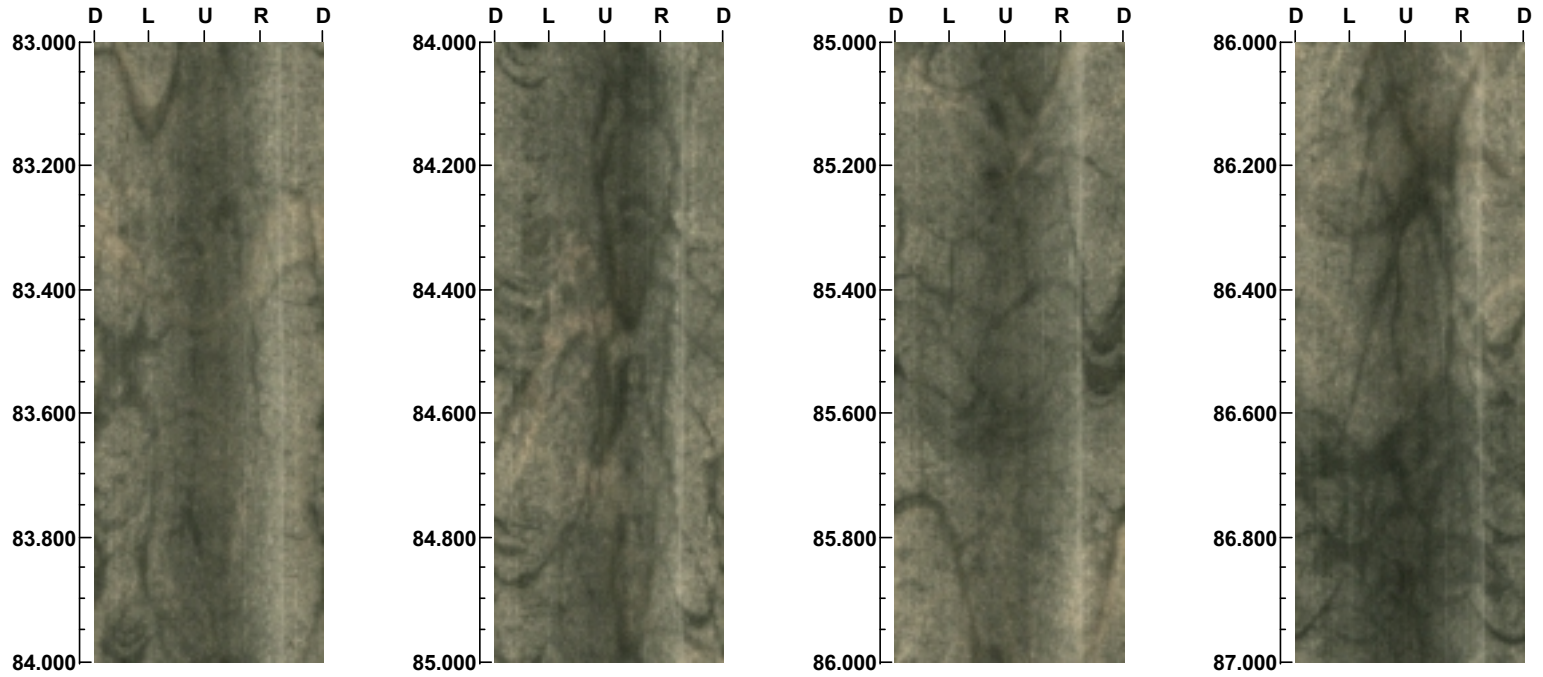

148

Project name: HSH02  
Bore hole No.: HSH02

Azimuth: 0      Inclination: -90

Depth range: 87.000 - 91.000 m

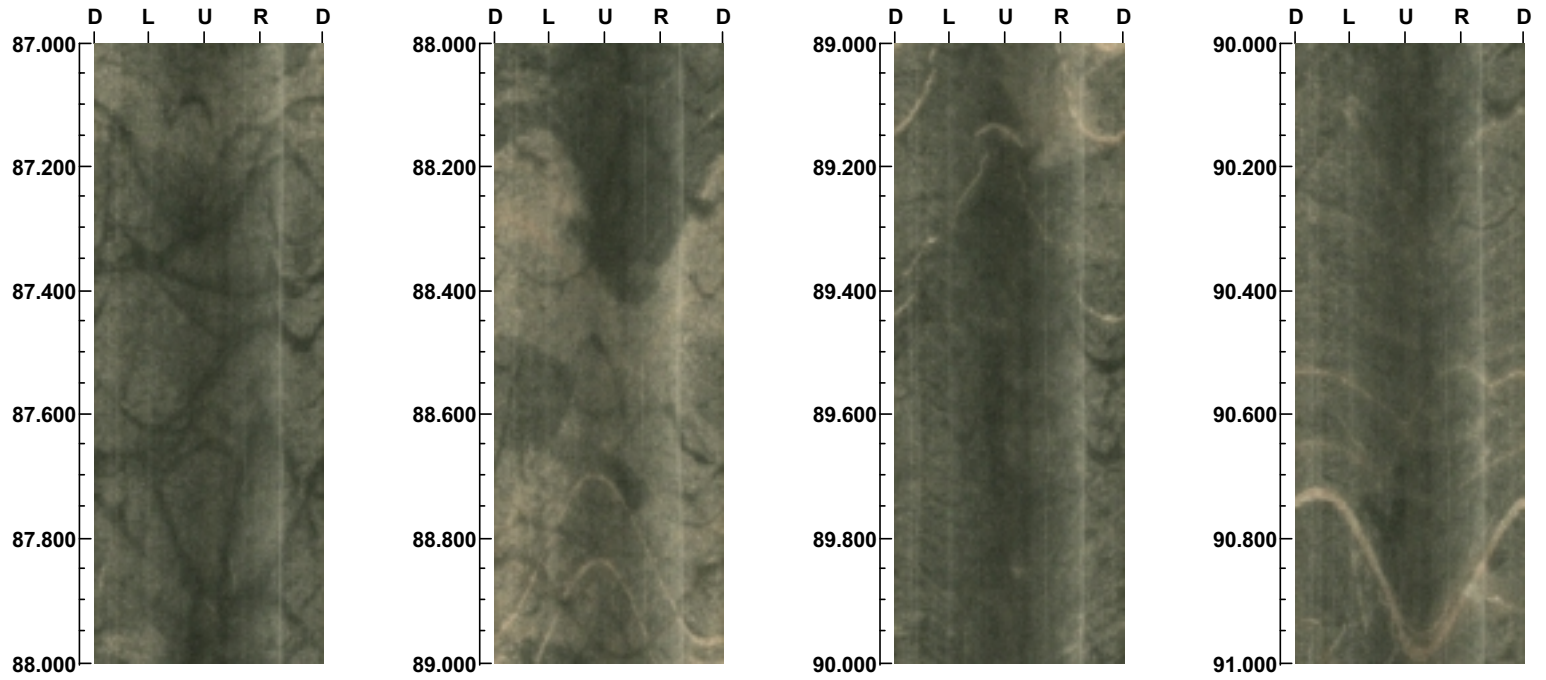

Project name: HSH02  
Bore hole No.: HSH02

Azimuth: 0      Inclination: -90

Depth range: 91.000 - 95.000 m

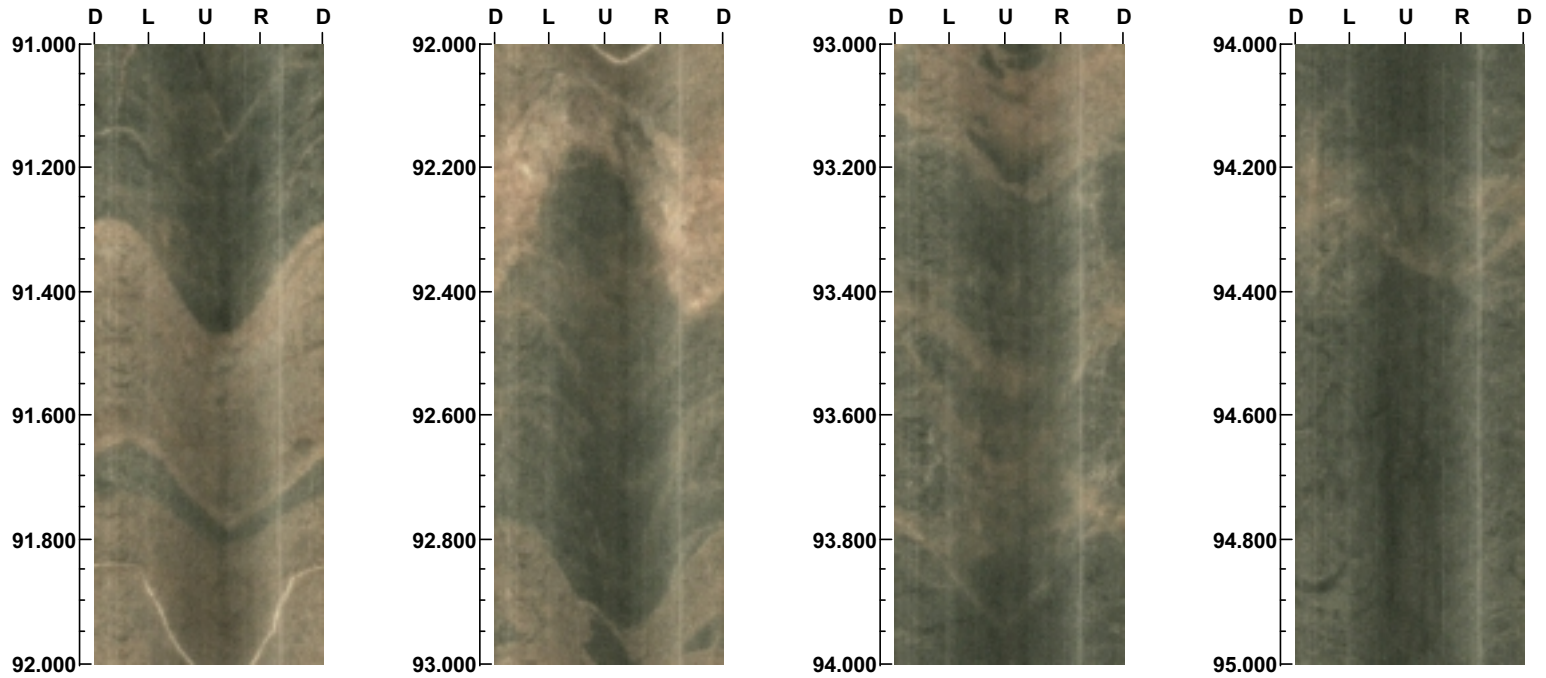

150

Project name: HSH02  
Bore hole No.: HSH02

Azimuth: 0      Inclination: -90

Depth range: 95.000 - 99.000 m

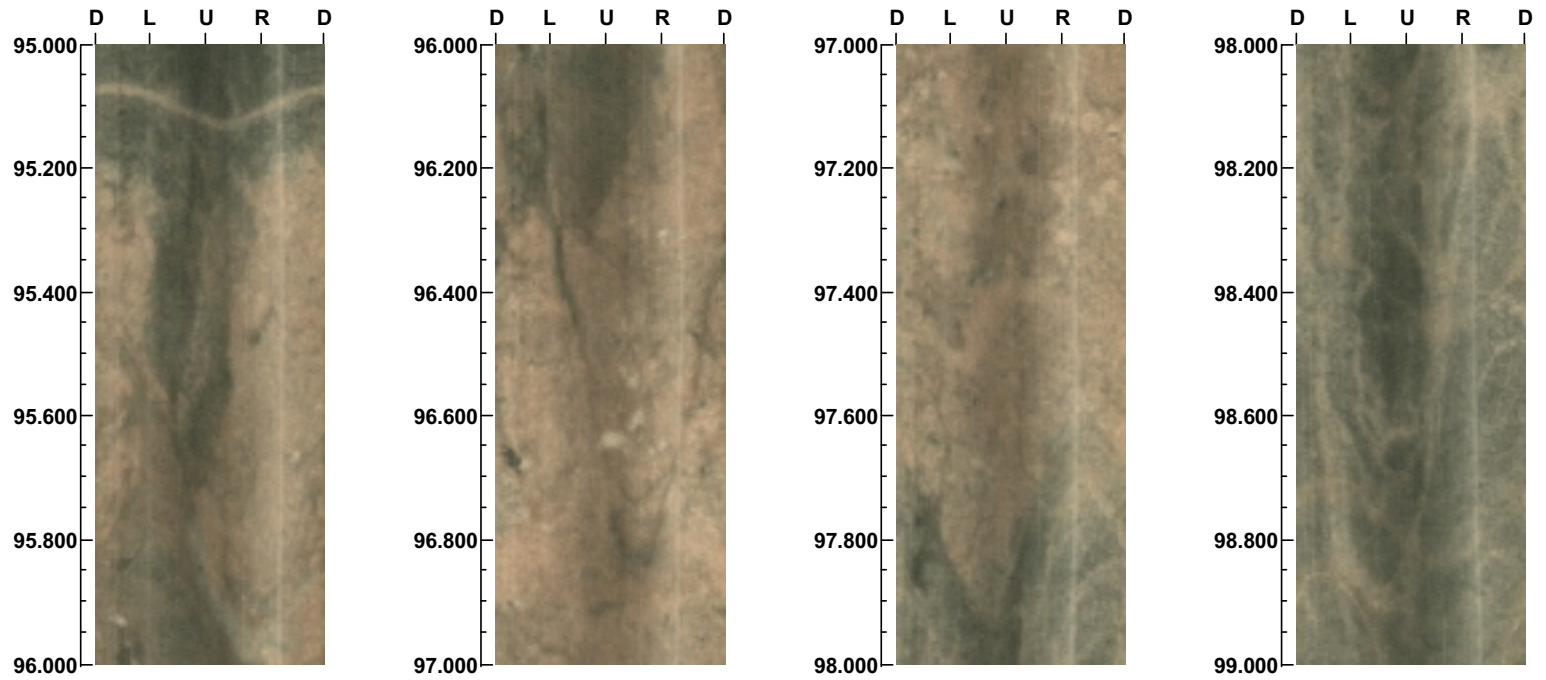

151



Project name: HSH02  
Bore hole No.: HSH02

Azimuth: 0      Inclination: -90

Depth range: 99.000 - 103.000 m

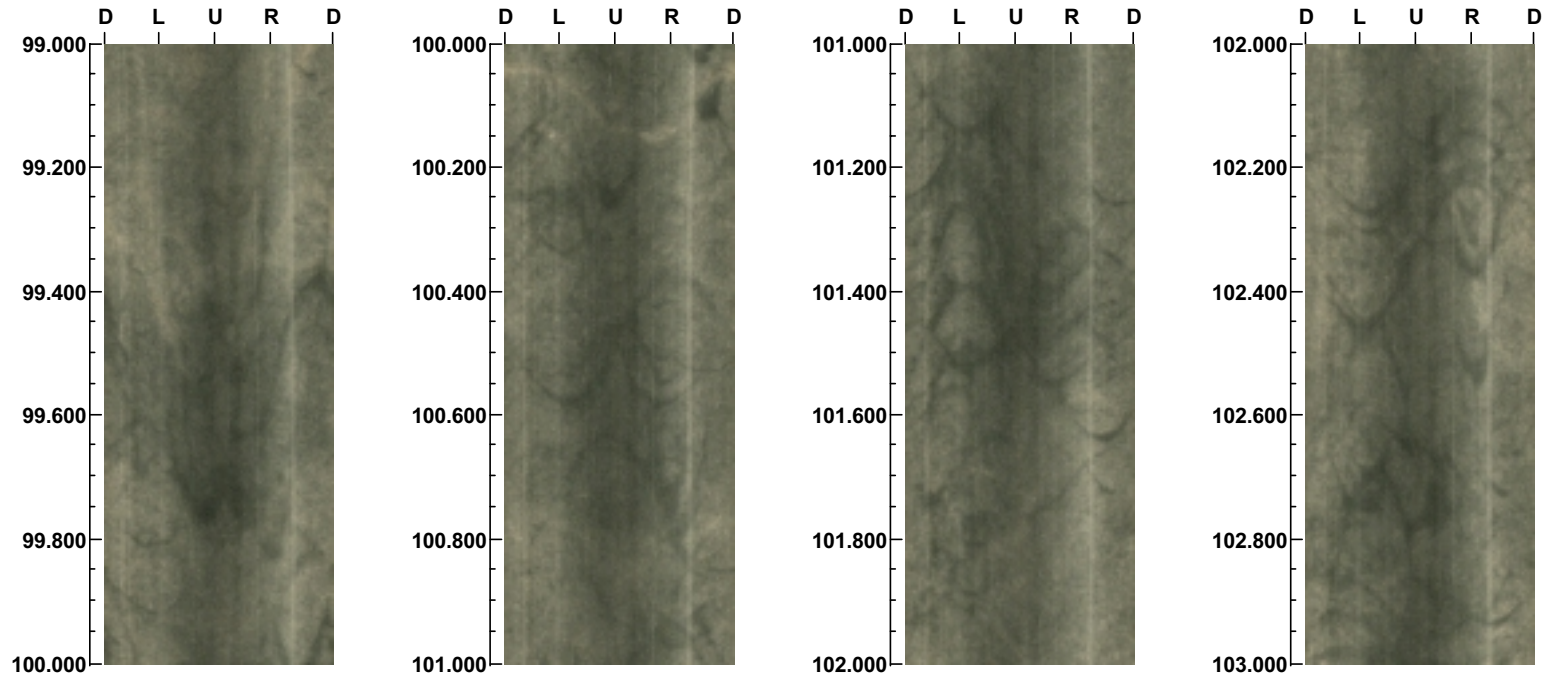

152

( 23 / 43 )

Scale: 1/10      Aspect ratio: 89 %



Project name: HSH02  
Bore hole No.: HSH02

Azimuth: 0      Inclination: -90

Depth range: 103.000 - 107.000 m

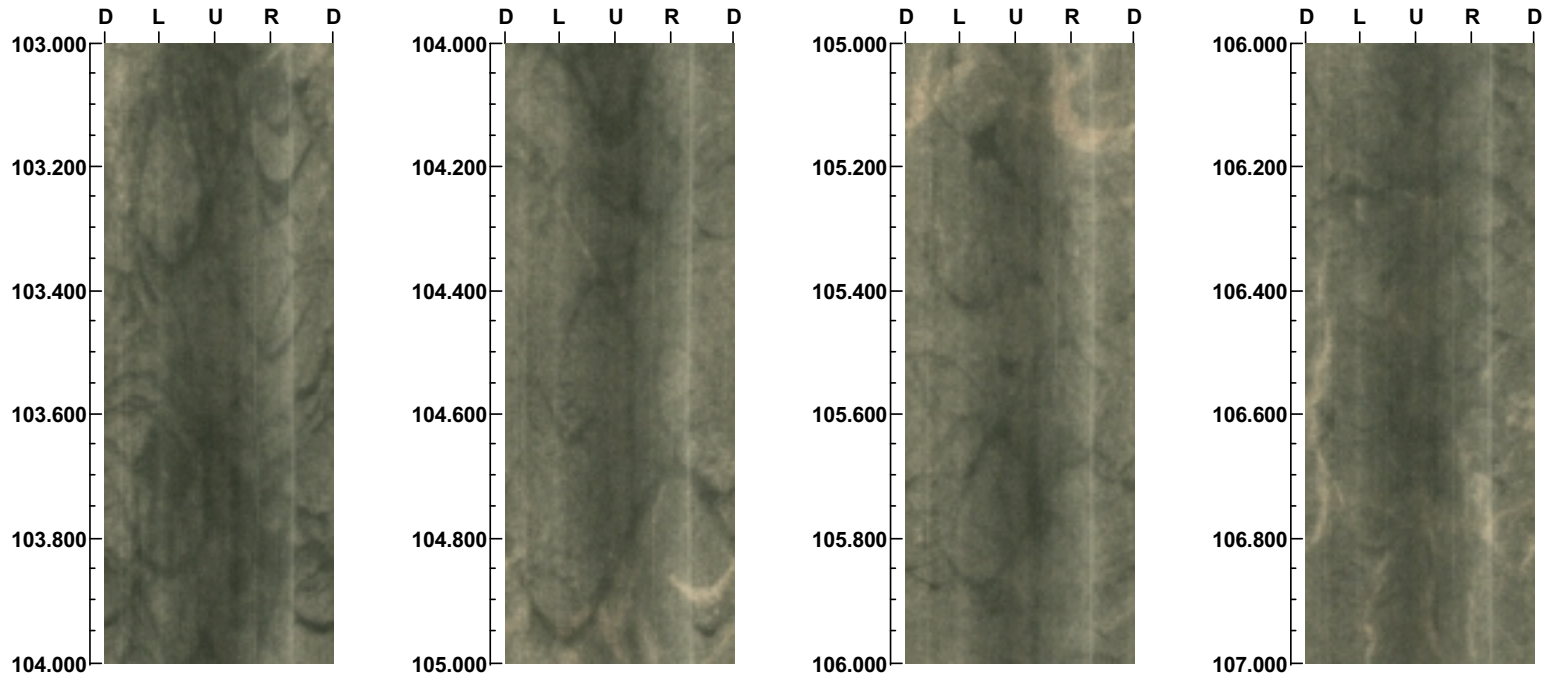

153

Project name: HSH02  
Bore hole No.: HSH02

Azimuth: 0      Inclination: -90

Depth range: 107.000 - 111.000 m

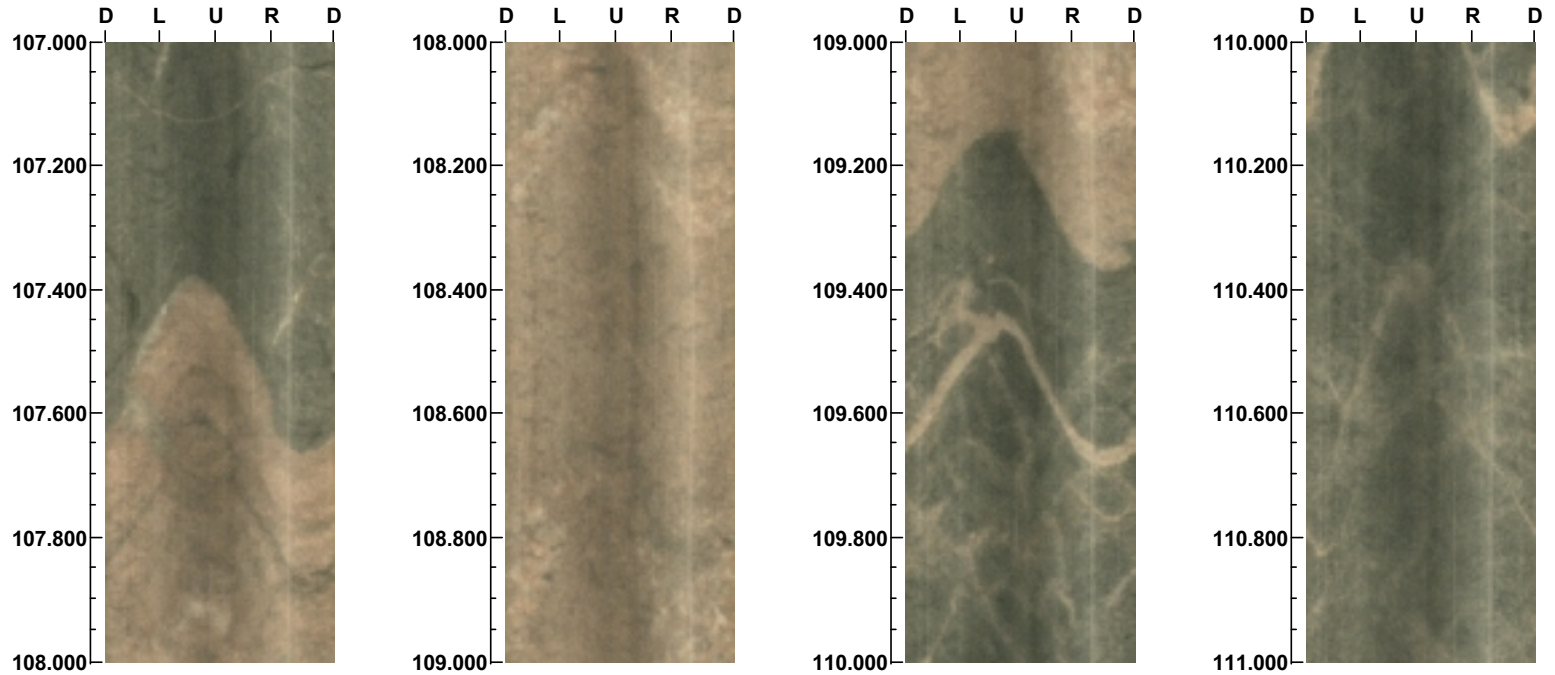

154

Project name: HSH02  
Bore hole No.: HSH02

Azimuth: 0      Inclination: -90

Depth range: 111.000 - 115.000 m

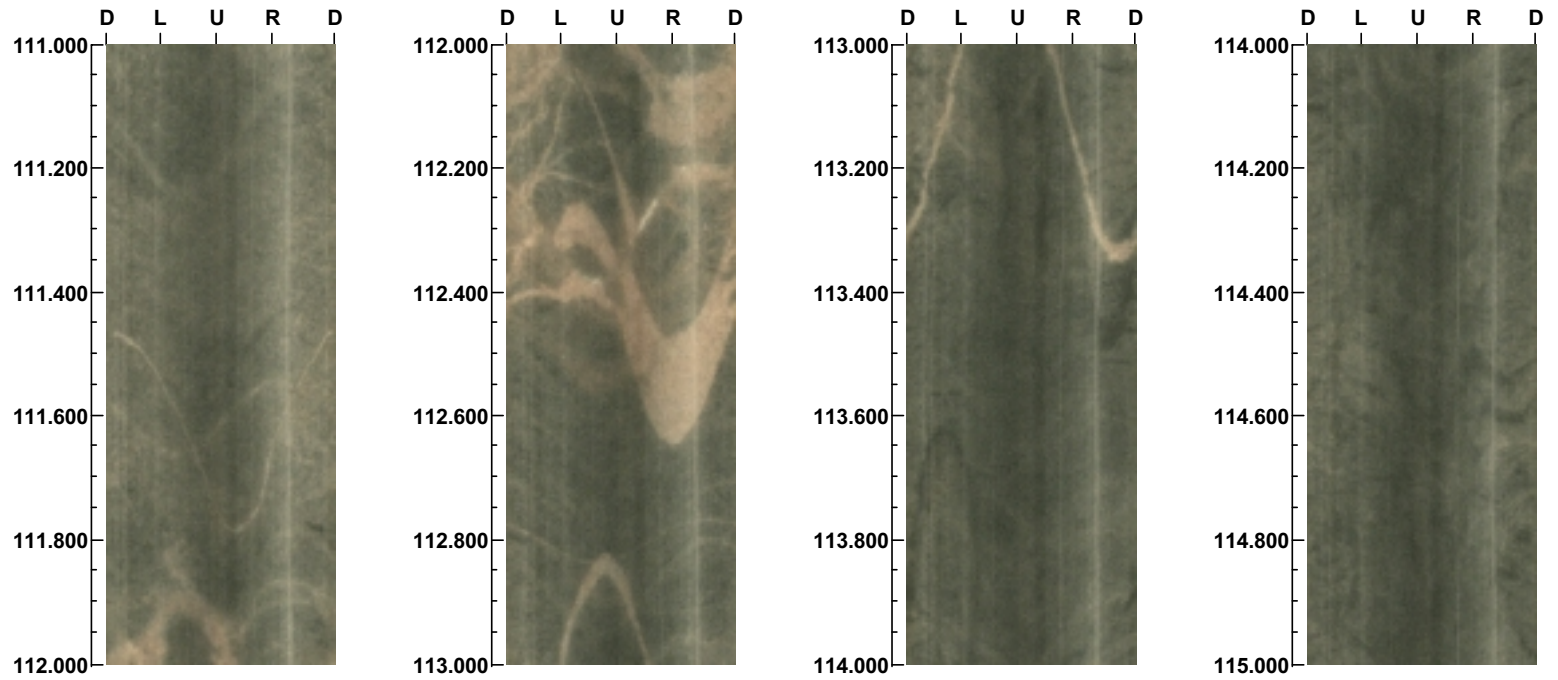

155

Project name: HSH02  
Bore hole No.: HSH02

Azimuth: 0      Inclination: -90

Depth range: 115.000 - 119.000 m

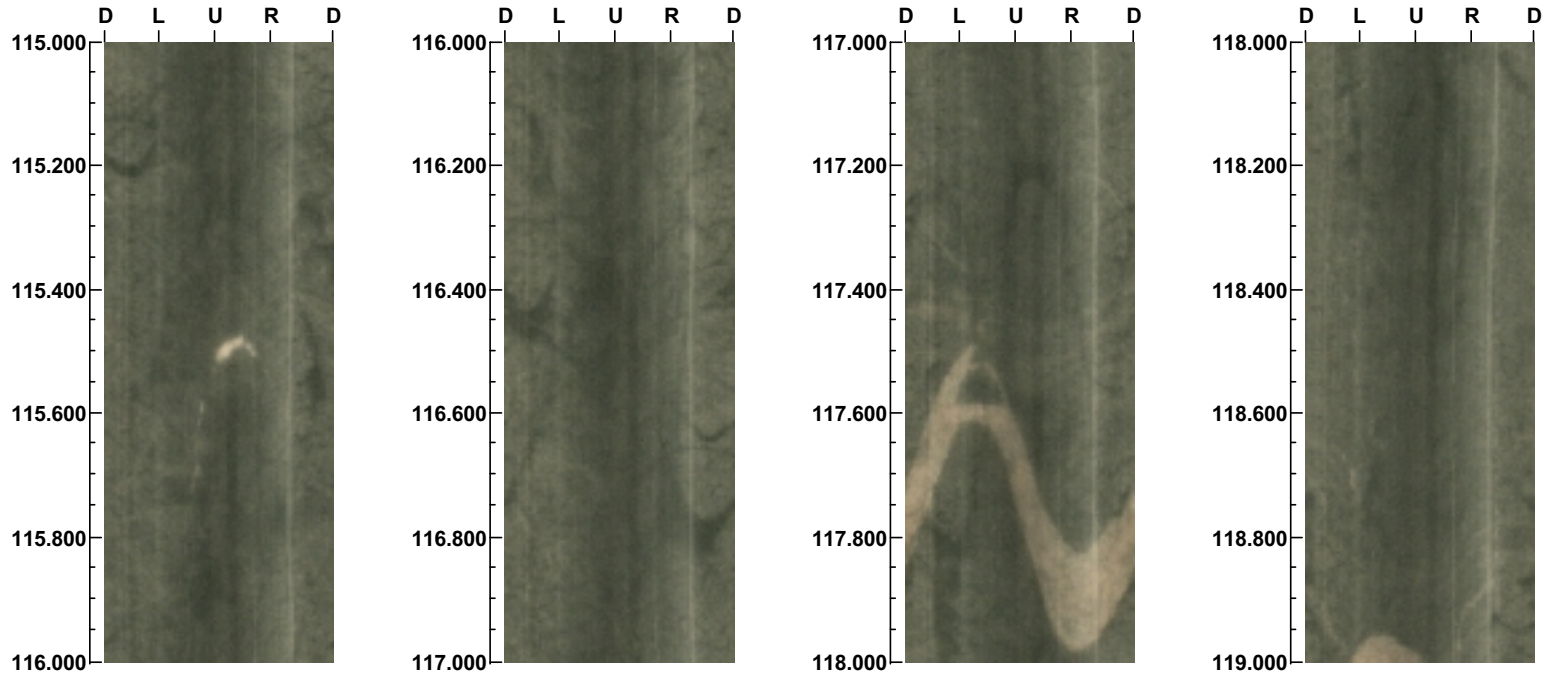

156

( 27 / 43 )

Scale: 1/10      Aspect ratio: 89 %

Project name: HSH02  
Bore hole No.: HSH02

Azimuth: 0      Inclination: -90

Depth range: 119.000 - 123.000 m

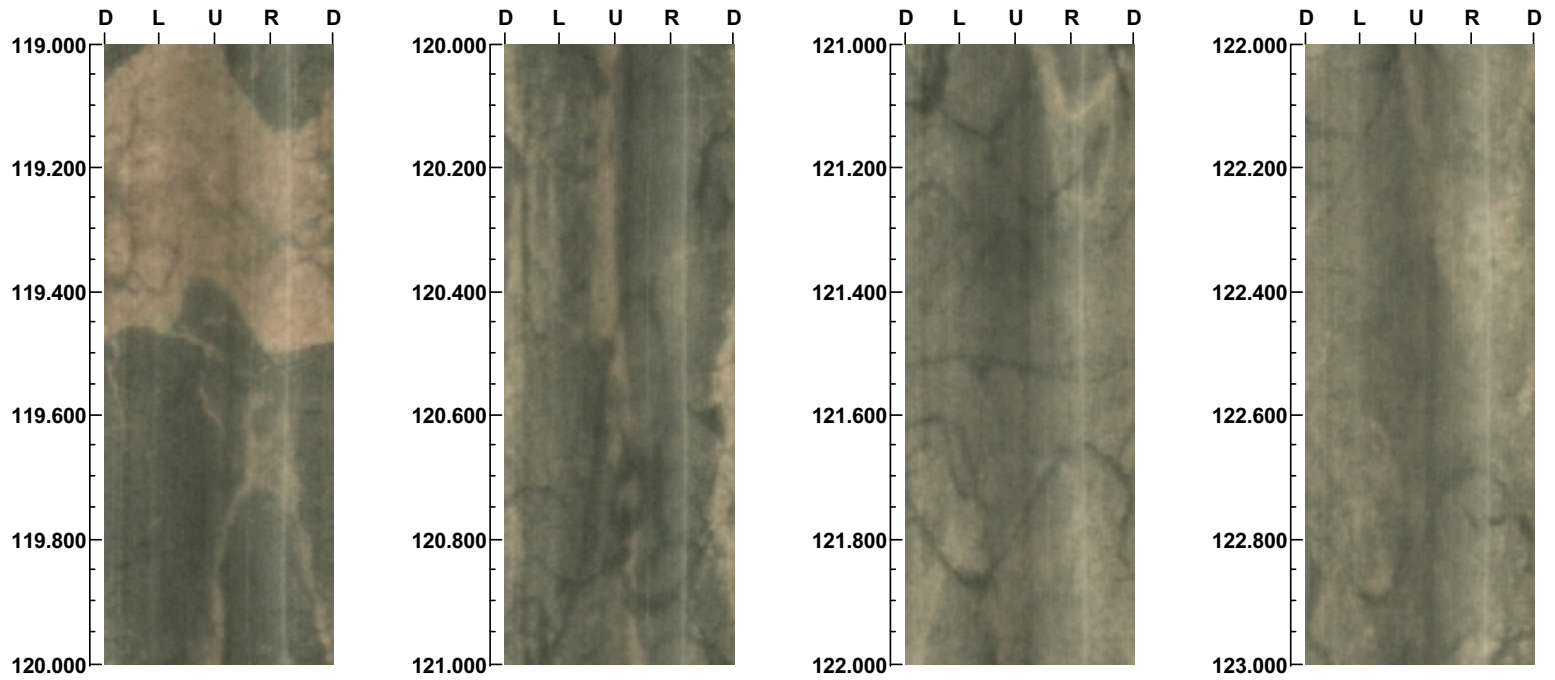

157

Project name: HSH02  
Bore hole No.: HSH02

Azimuth: 0      Inclination: -90

Depth range: 123.000 - 127.000 m

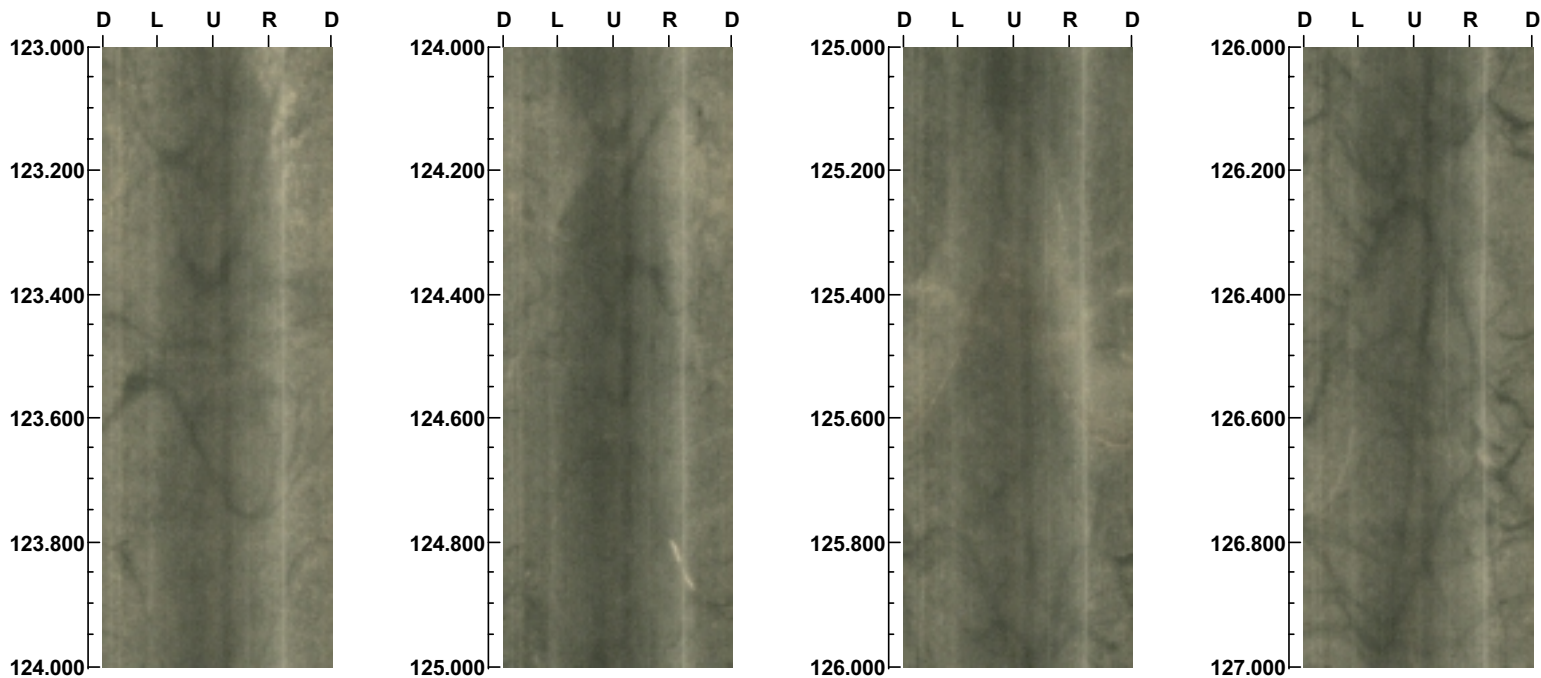

158



Project name: HSH02  
Bore hole No.: HSH02

Azimuth: 0      Inclination: -90

Depth range: 127.000 - 131.000 m

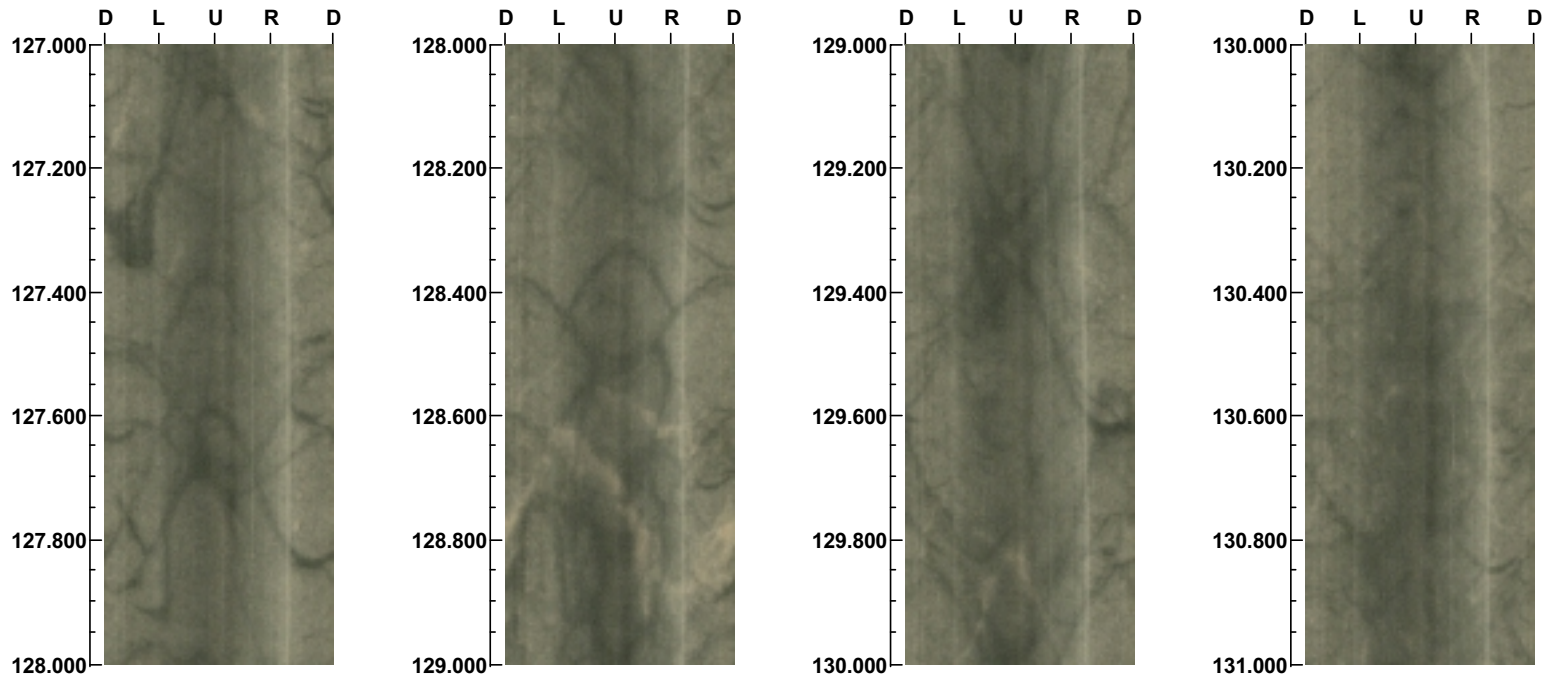

159

Project name: HSH02  
Bore hole No.: HSH02

Azimuth: 0      Inclination: -90

Depth range: 131.000 - 135.000 m

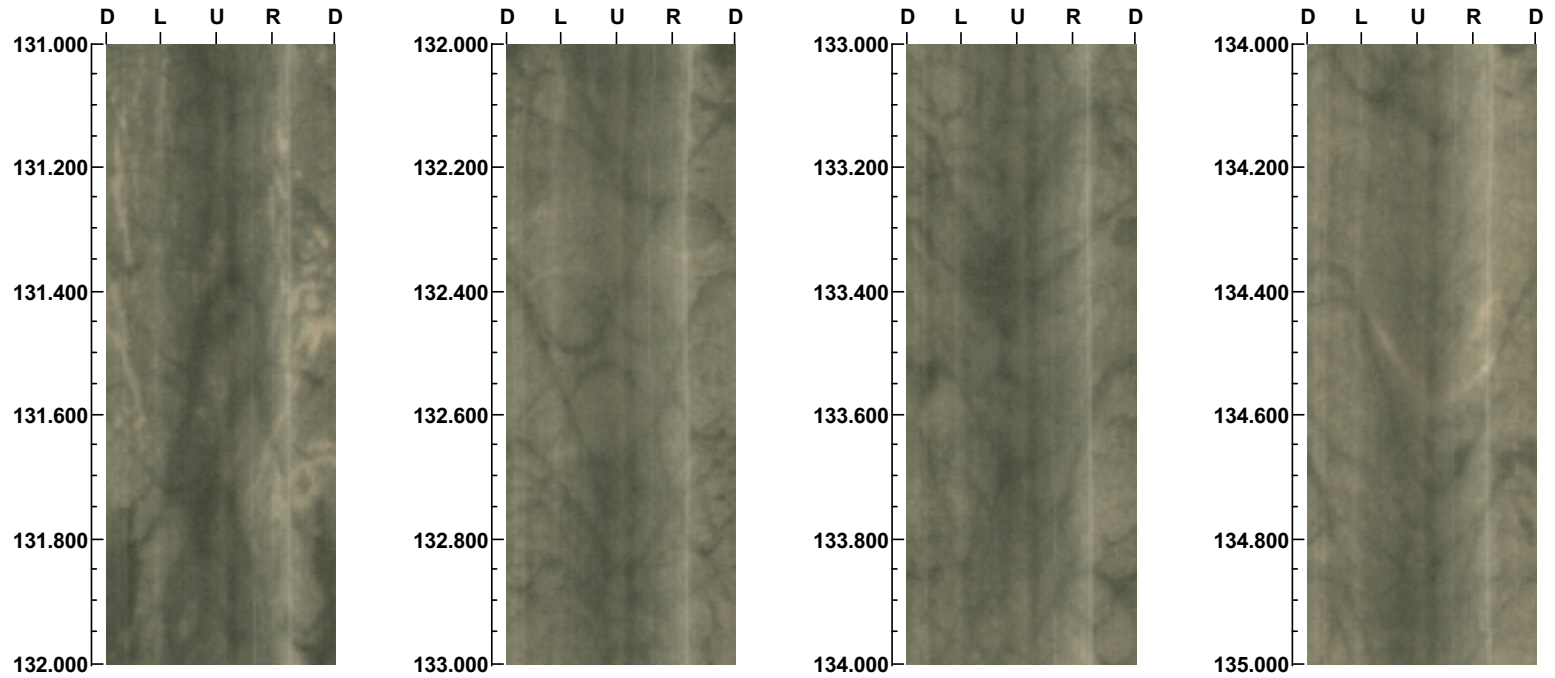

160

Project name: HSH02  
Bore hole No.: HSH02

Azimuth: 0      Inclination: -90

Depth range: 135.000 - 139.000 m

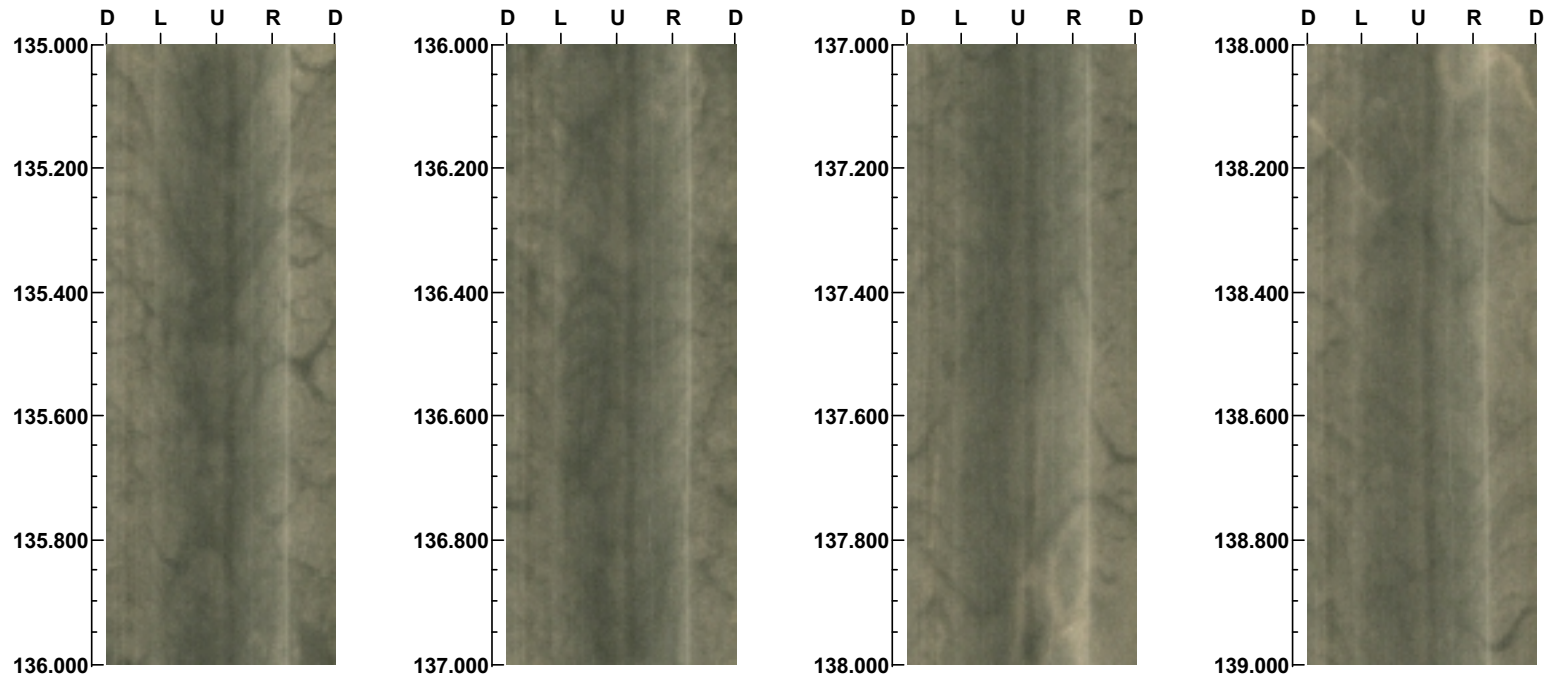

Project name: HSH02  
Bore hole No.: HSH02

Azimuth: 0      Inclination: -90

Depth range: 139.000 - 143.000 m

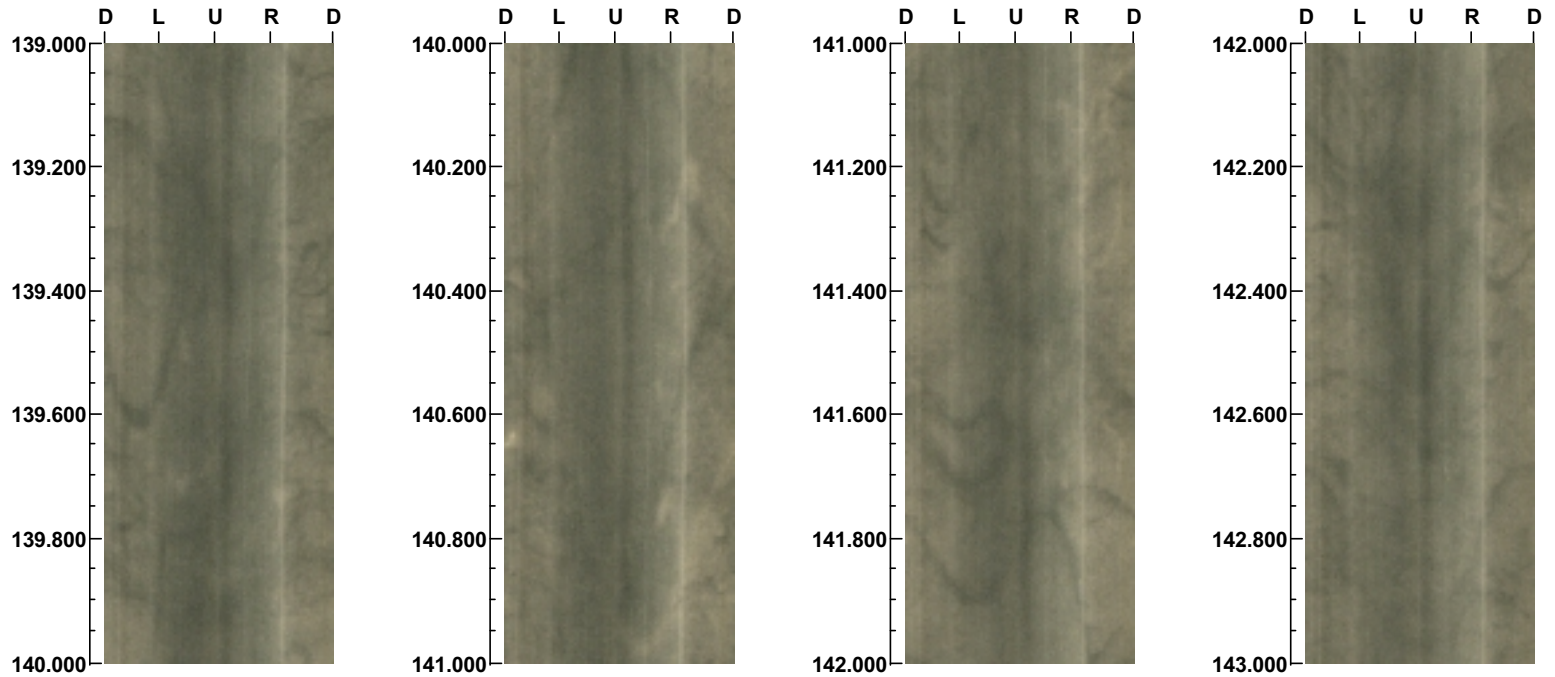

Project name: HSH02  
Bore hole No.: HSH02

Azimuth: 0      Inclination: -90

Depth range: 143.000 - 147.000 m

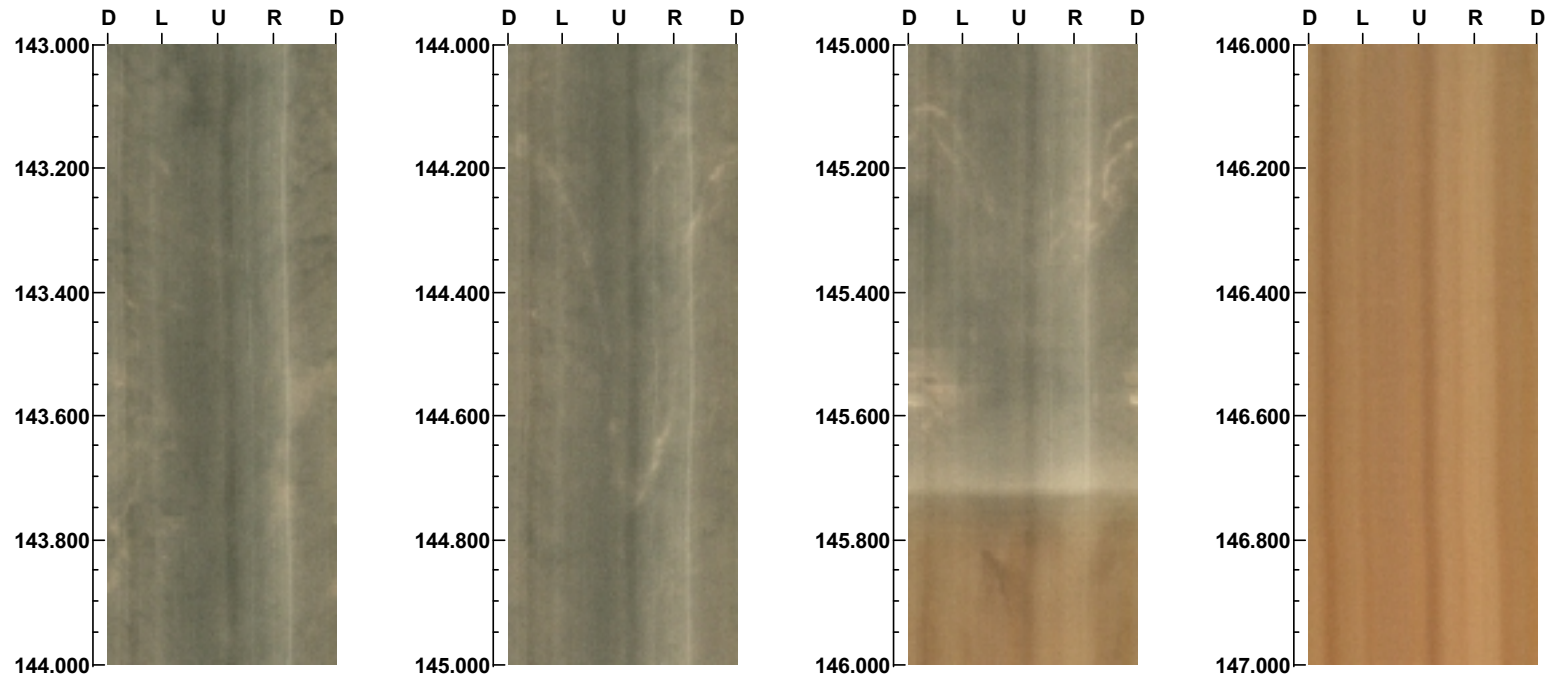

163

Project name: HSH02  
Bore hole No.: HSH02

Azimuth: 0      Inclination: -90

Depth range: 147.000 - 151.000 m

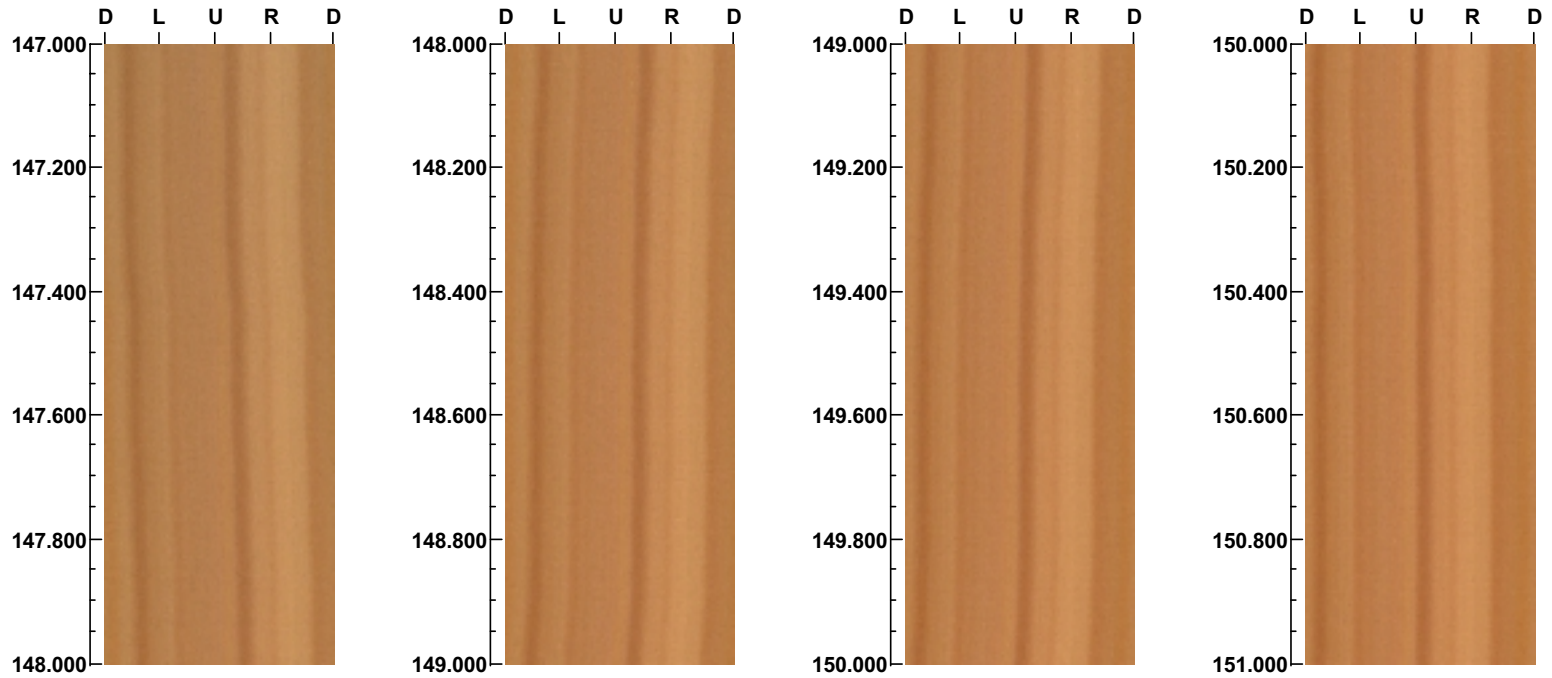



Project name: HSH02  
Bore hole No.: HSH02

Azimuth: 0      Inclination: -90

Depth range: 151.000 - 155.000 m

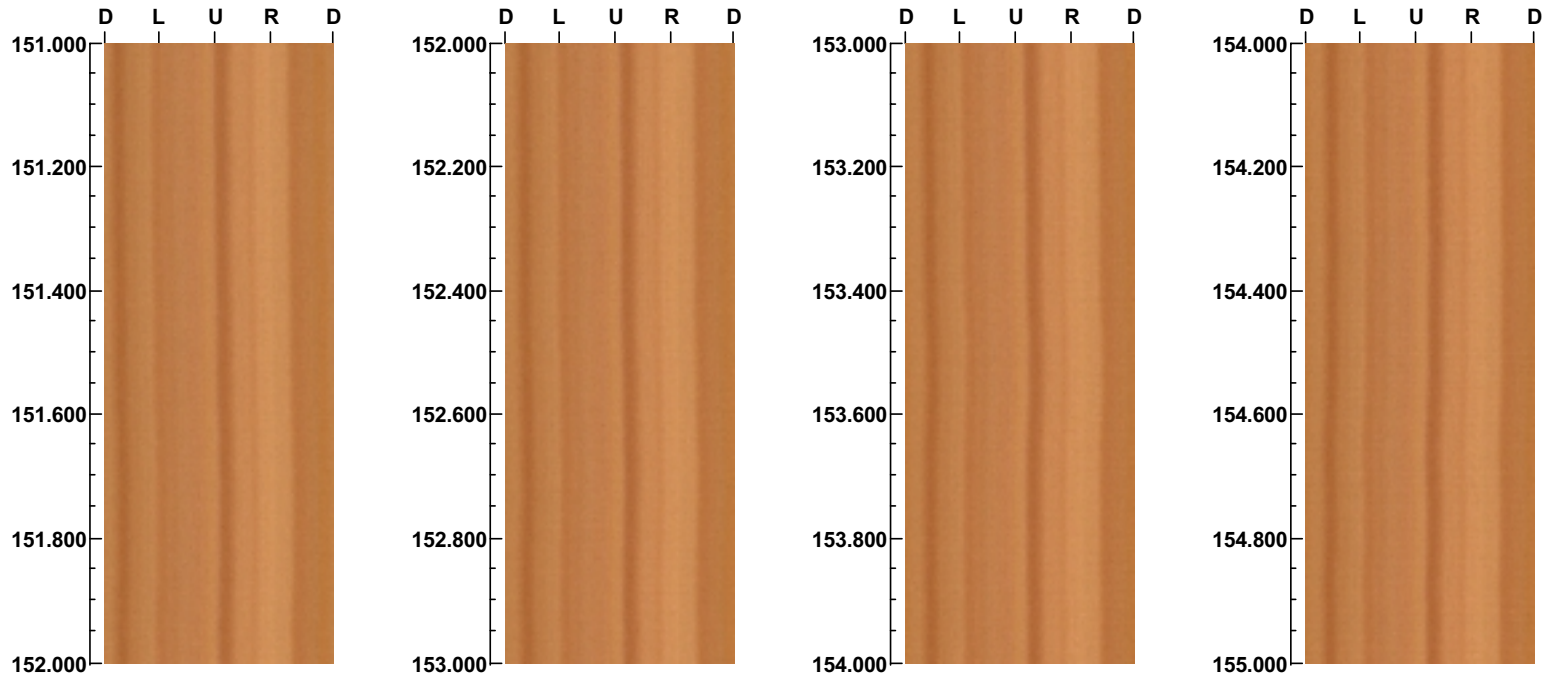

165

Project name: HSH02  
Bore hole No.: HSH02

Azimuth: 0      Inclination: -90

Depth range: 155.000 - 159.000 m

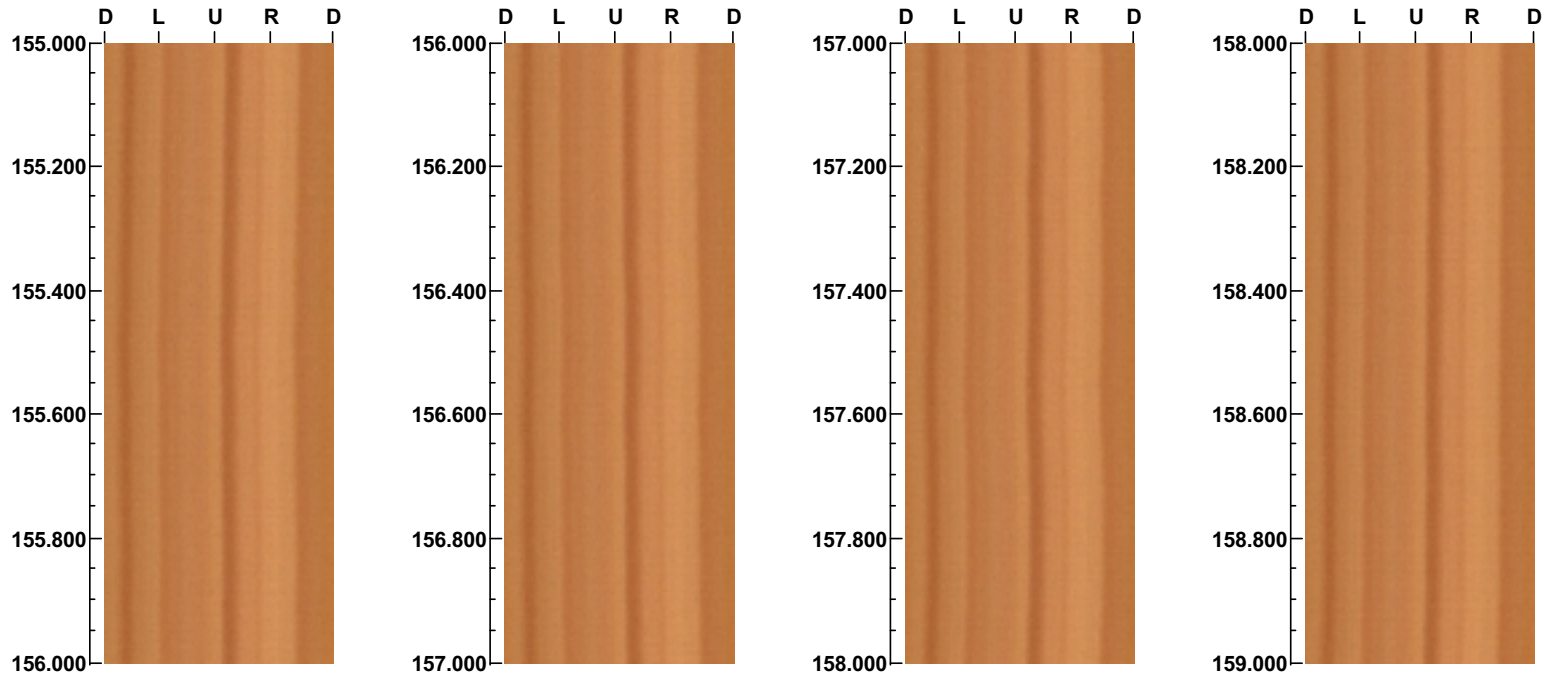

Project name: HSH02  
Bore hole No.: HSH02

Azimuth: 0      Inclination: -90

Depth range: 159.000 - 163.000 m

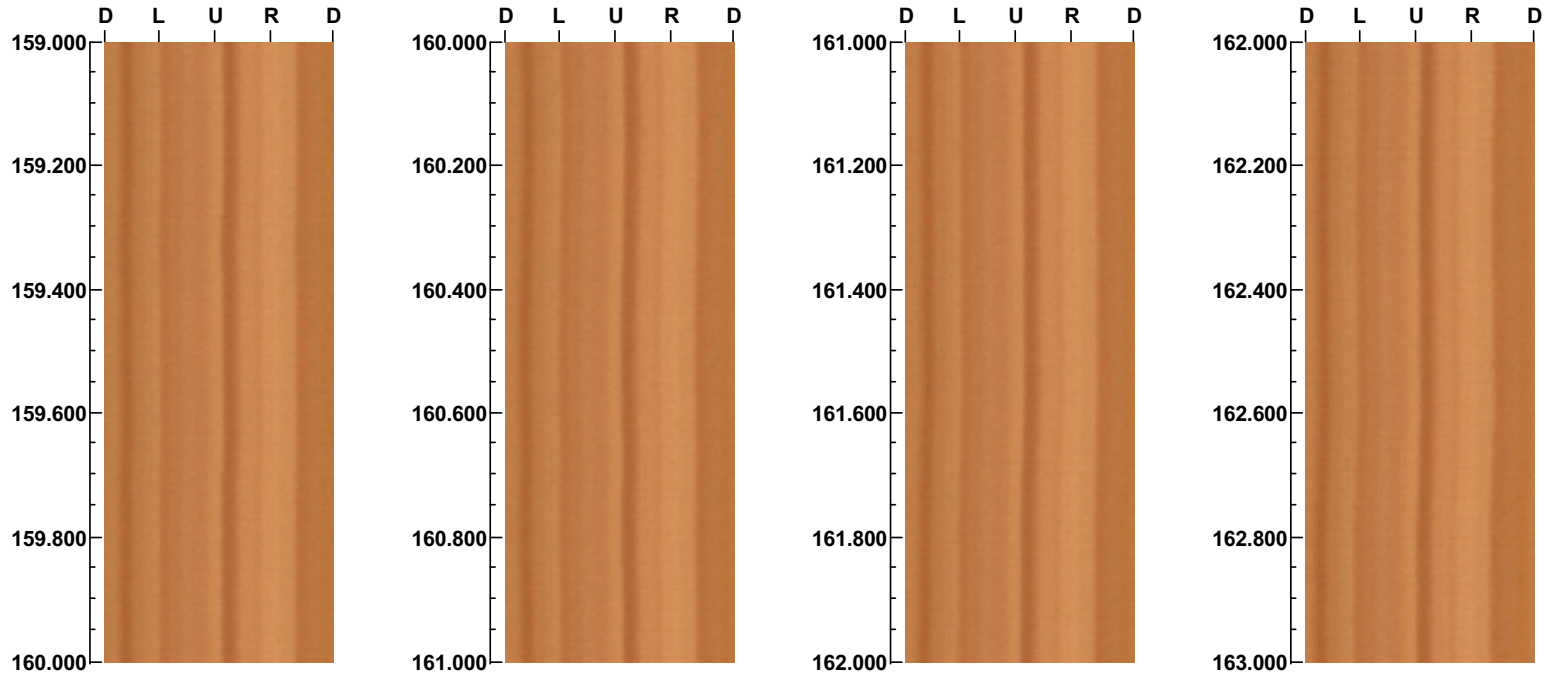

167

Project name: HSH02  
Bore hole No.: HSH02

Azimuth: 0      Inclination: -90

Depth range: 163.000 - 167.000 m

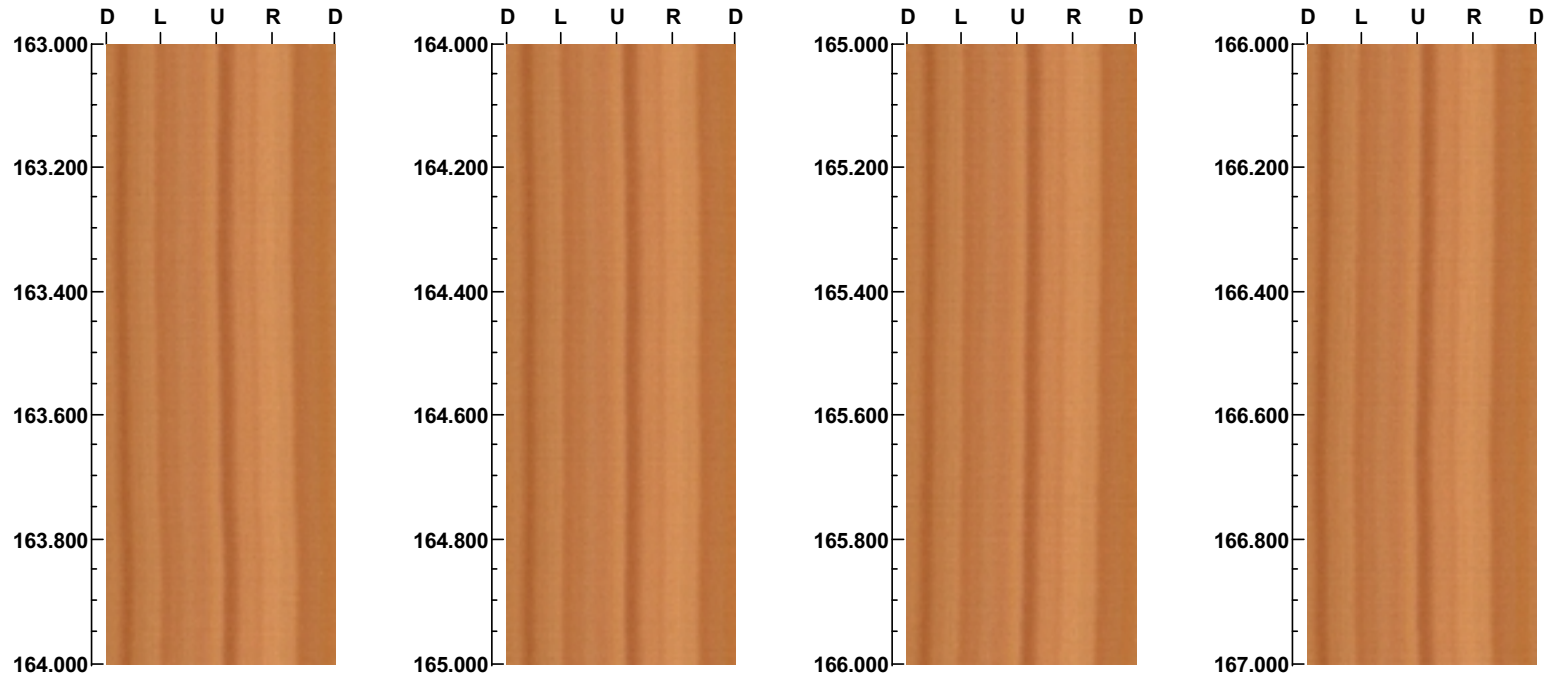

168

Project name: HSH02  
Bore hole No.: HSH02

Azimuth: 0      Inclination: -90

Depth range: 167.000 - 171.000 m

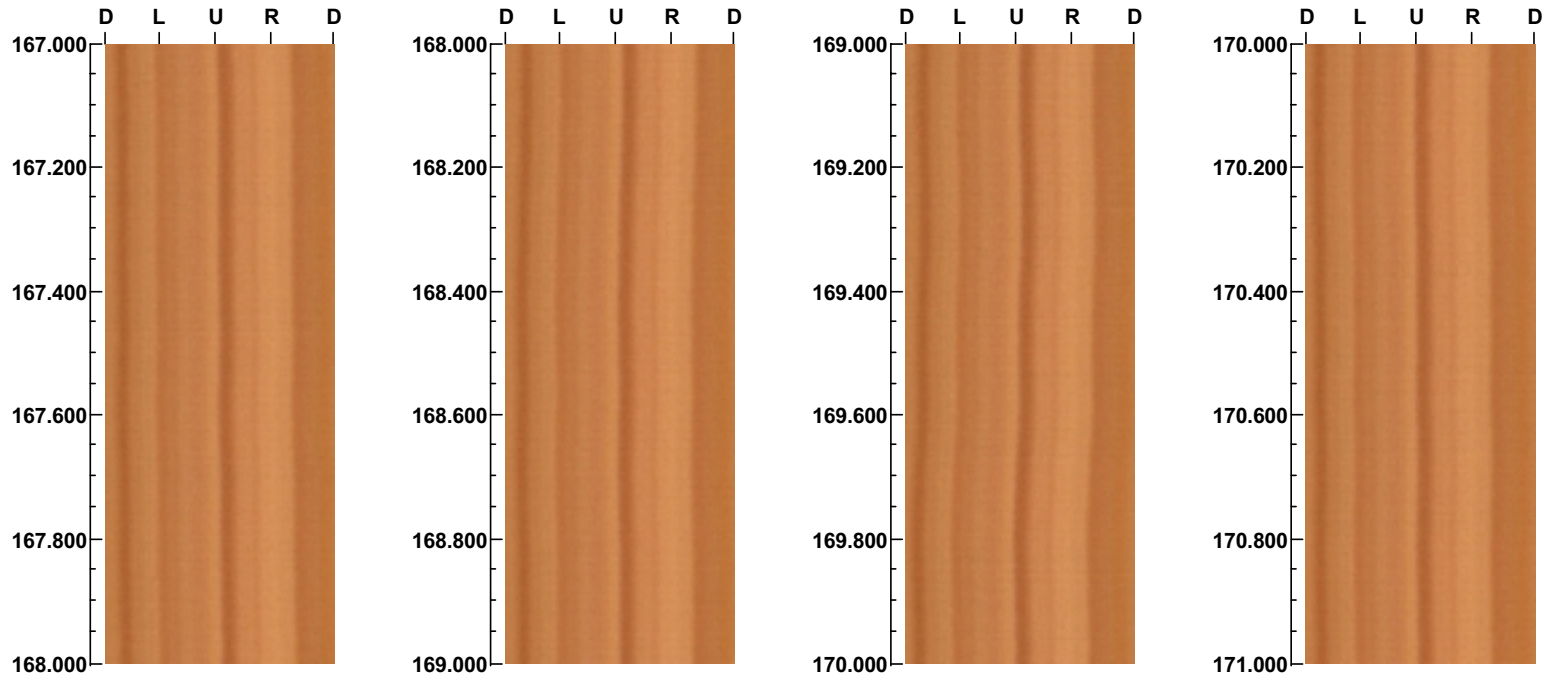

169

Project name: HSH02  
Bore hole No.: HSH02

Azimuth: 0      Inclination: -90

Depth range: 171.000 - 175.000 m

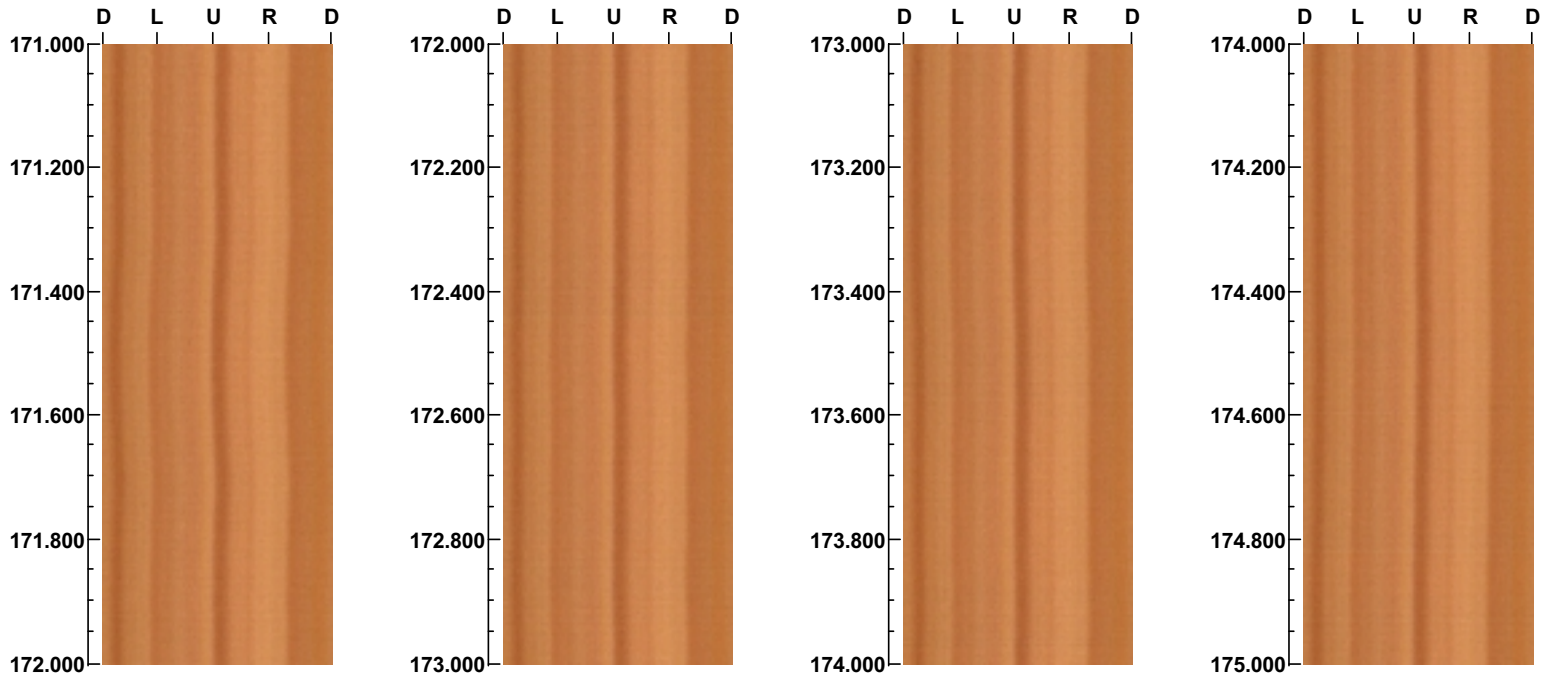

170

Project name: HSH02  
Bore hole No.: HSH02

Azimuth: 0      Inclination: -90

Depth range: 175.000 - 179.000 m

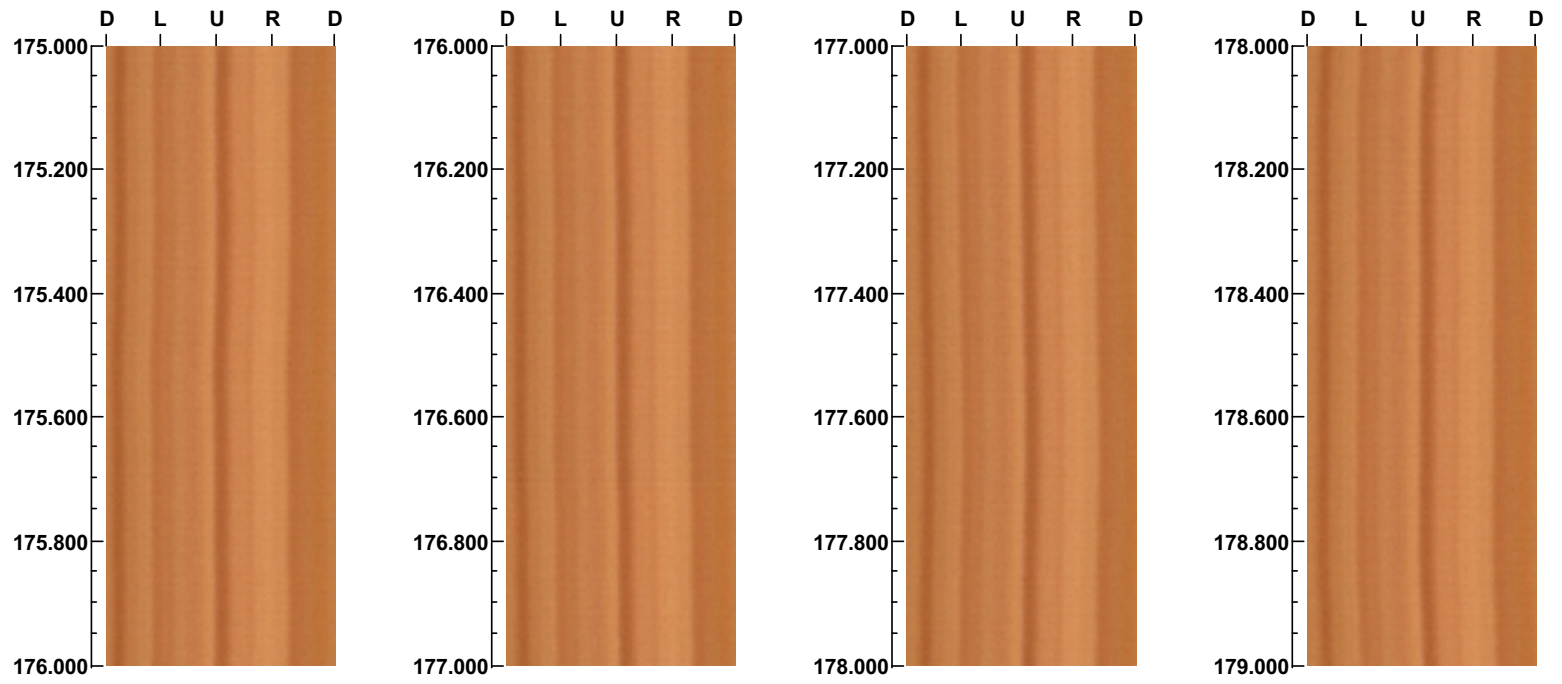



Project name: HSH02  
Bore hole No.: HSH02

Azimuth: 0      Inclination: -90

Depth range: 179.000 - 179.993 m

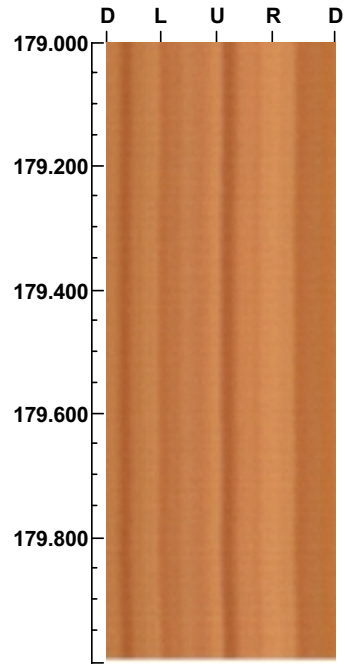

172

( 43 / 43 )

Scale: 1/10      Aspect ratio: 89 %

**BIPS results from HSH03**

**Project name: HSH03**

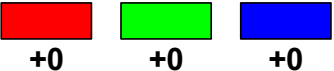
**Image file** : c:\gurraw~1\oskars~1\bips\hsh03\000.bip  
**BDT file** :  
**Locality** : SIMPAN  
**Bore hole number** : HSH03  
**Date** : 02/09/16  
**Time** : 10:35:00  
**Depth range** : 11.000 - 195.575 m  
**Azimuth** : 0  
**Inclination** : -90  
**Diameter** : 132.0 mm  
**Magnetic declination** : 0.0  
**Span** : 4  
**Scan interval** : 0.25  
**Scan direction** : To bottom  
**Scale** : 1/10  
**Aspect ratio** : 89 %  
**Pages** : 47  
**Color** : 

Project name: HSH03  
Bore hole No.: HSH03

Azimuth: 0      Inclination: -90

Depth range: 11.000 - 15.000 m

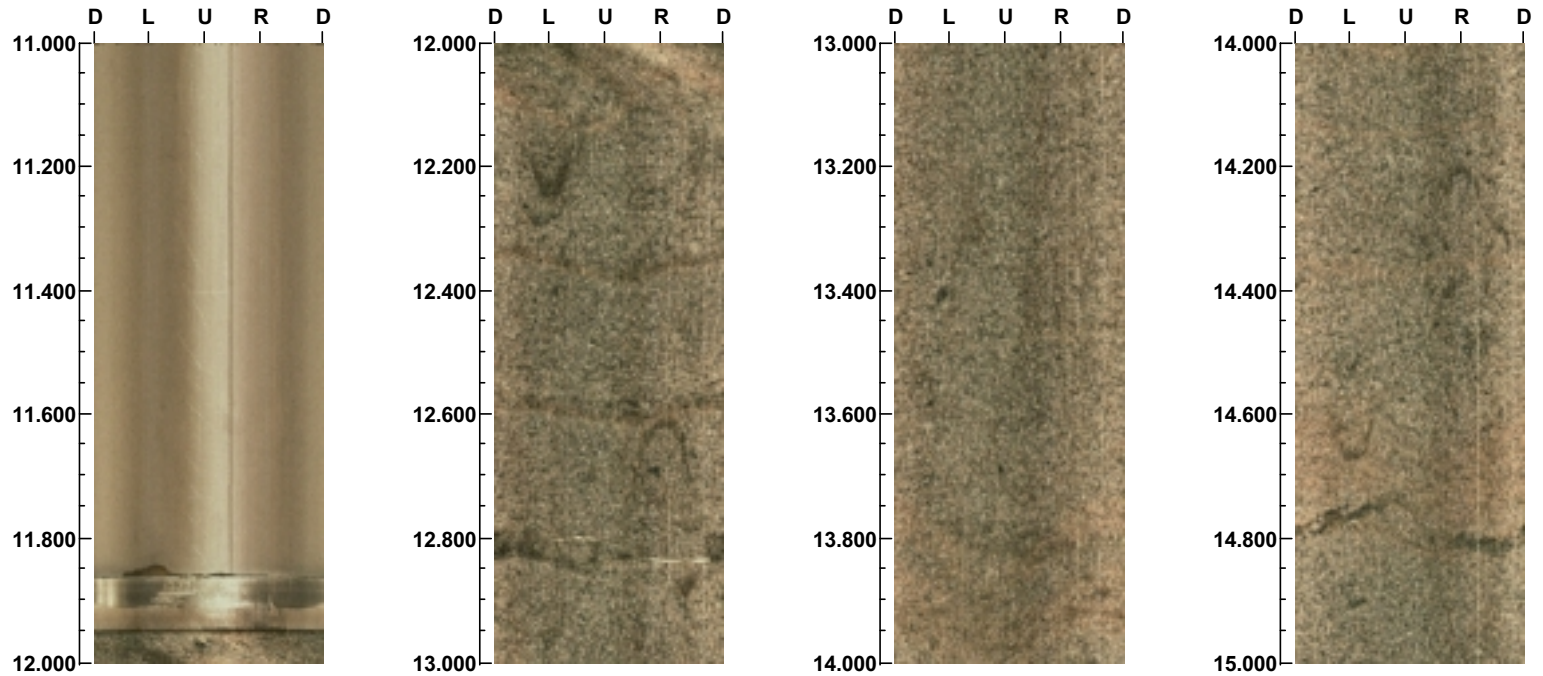

174

( 1 / 47 )

Scale: 1/10      Aspect ratio: 89 %

Project name: HSH03  
Bore hole No.: HSH03

Azimuth: 0      Inclination: -90

Depth range: 15.000 - 19.000 m

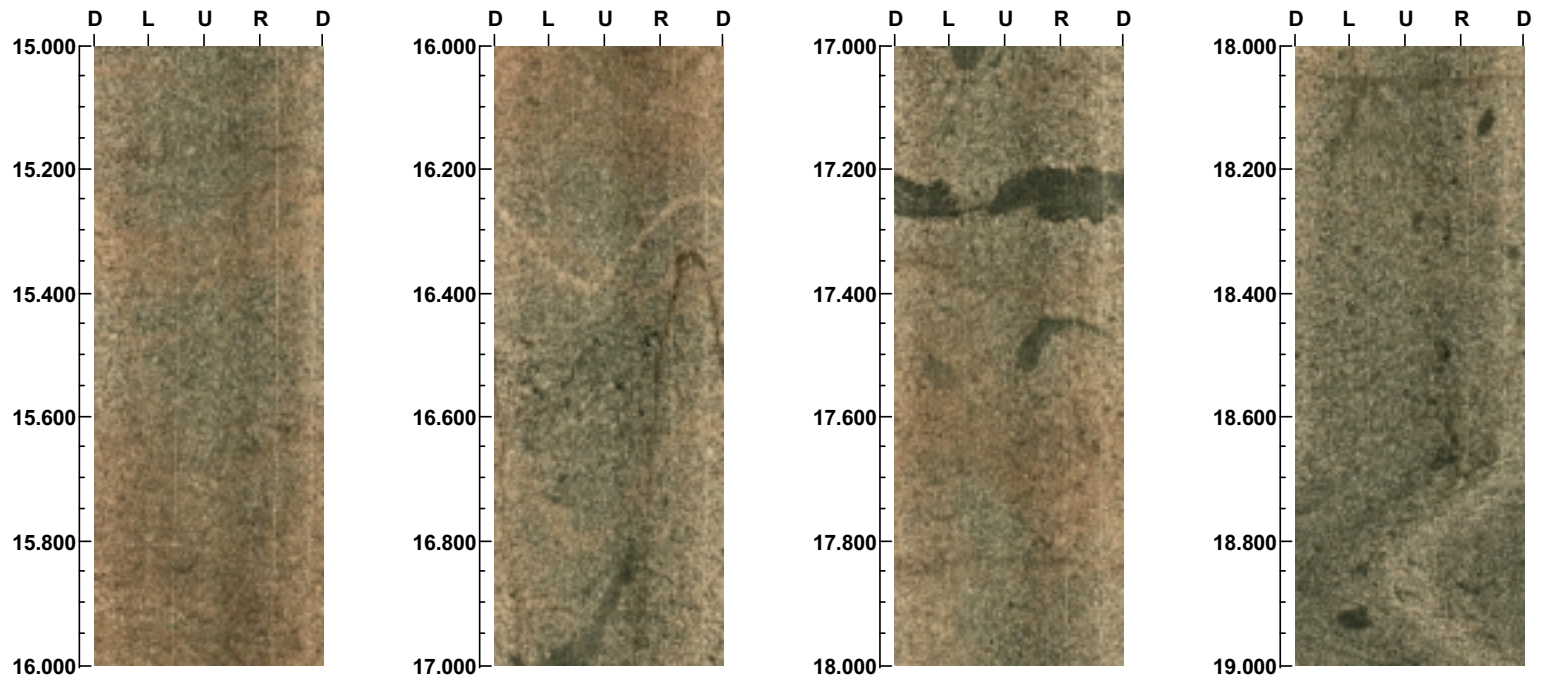

175

( 2 / 47 )

Scale: 1/10      Aspect ratio: 89 %

Project name: HSH03  
Bore hole No.: HSH03

Azimuth: 0      Inclination: -90

Depth range: 19.000 - 23.000 m

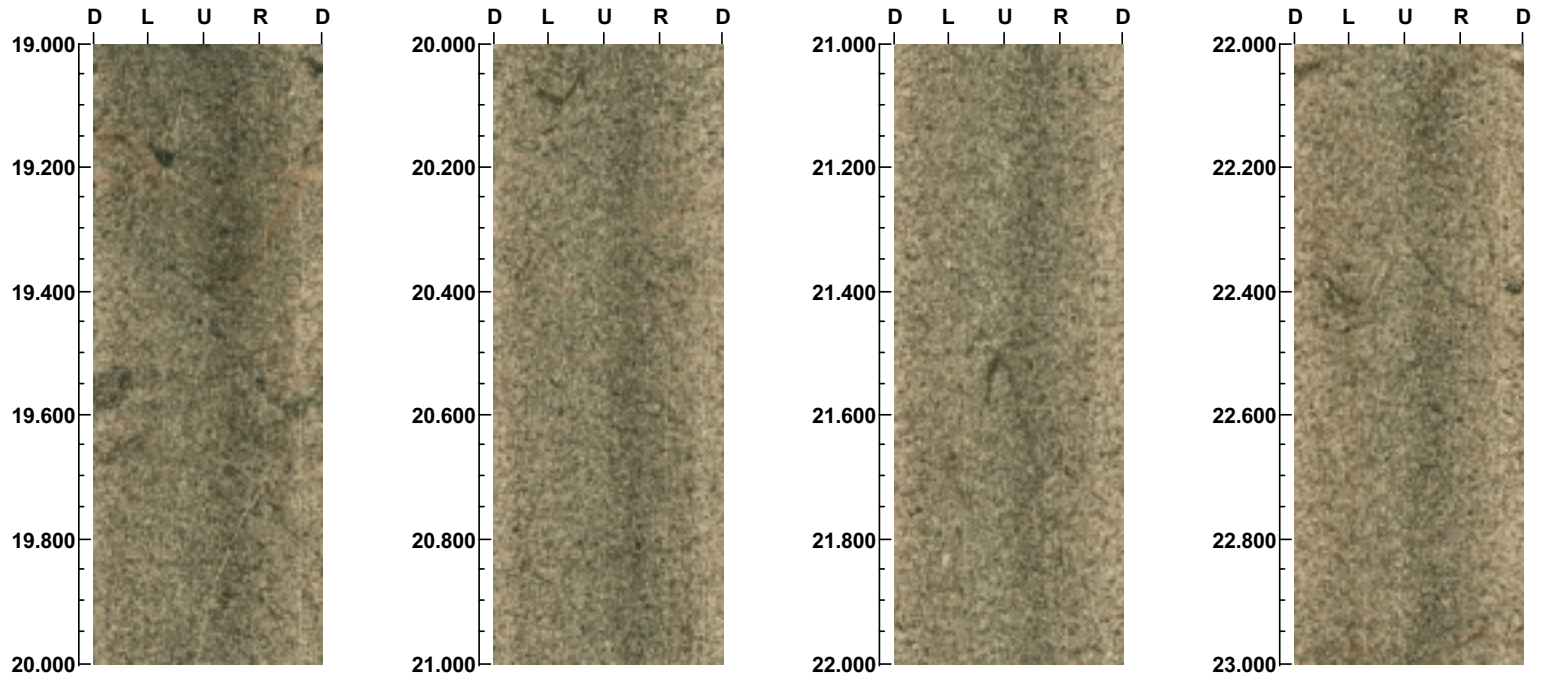

Project name: HSH03  
Bore hole No.: HSH03

Azimuth: 0      Inclination: -90

Depth range: 23.000 - 27.000 m

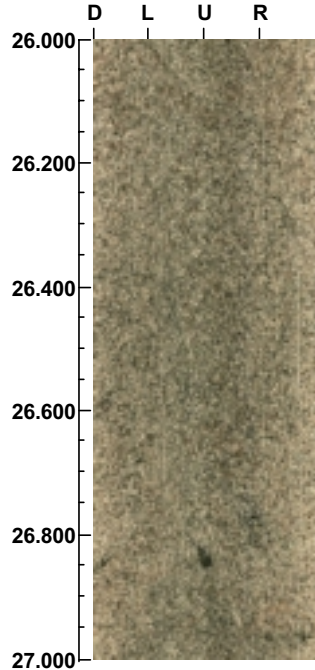
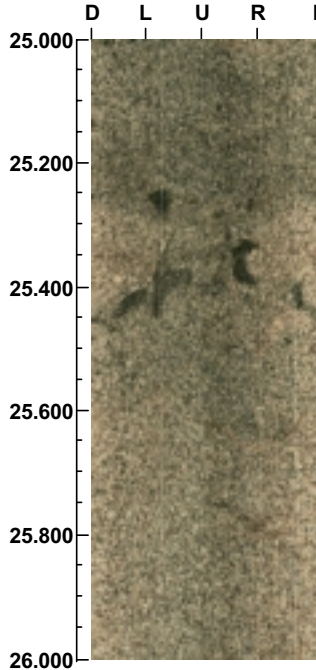
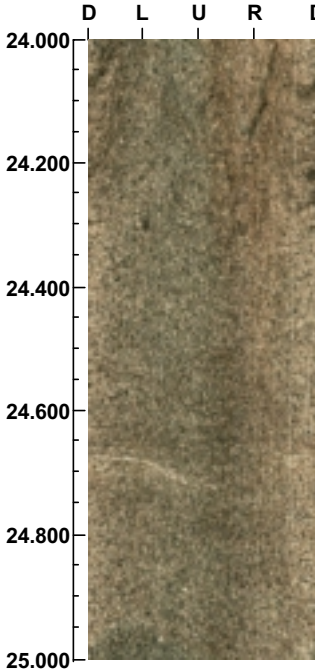
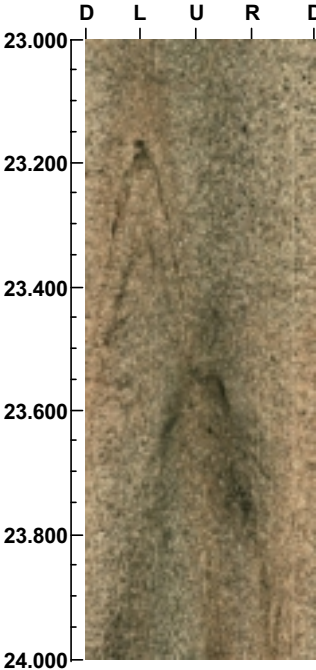



Project name: HSH03  
Bore hole No.: HSH03

Azimuth: 0      Inclination: -90

Depth range: 27.000 - 31.000 m

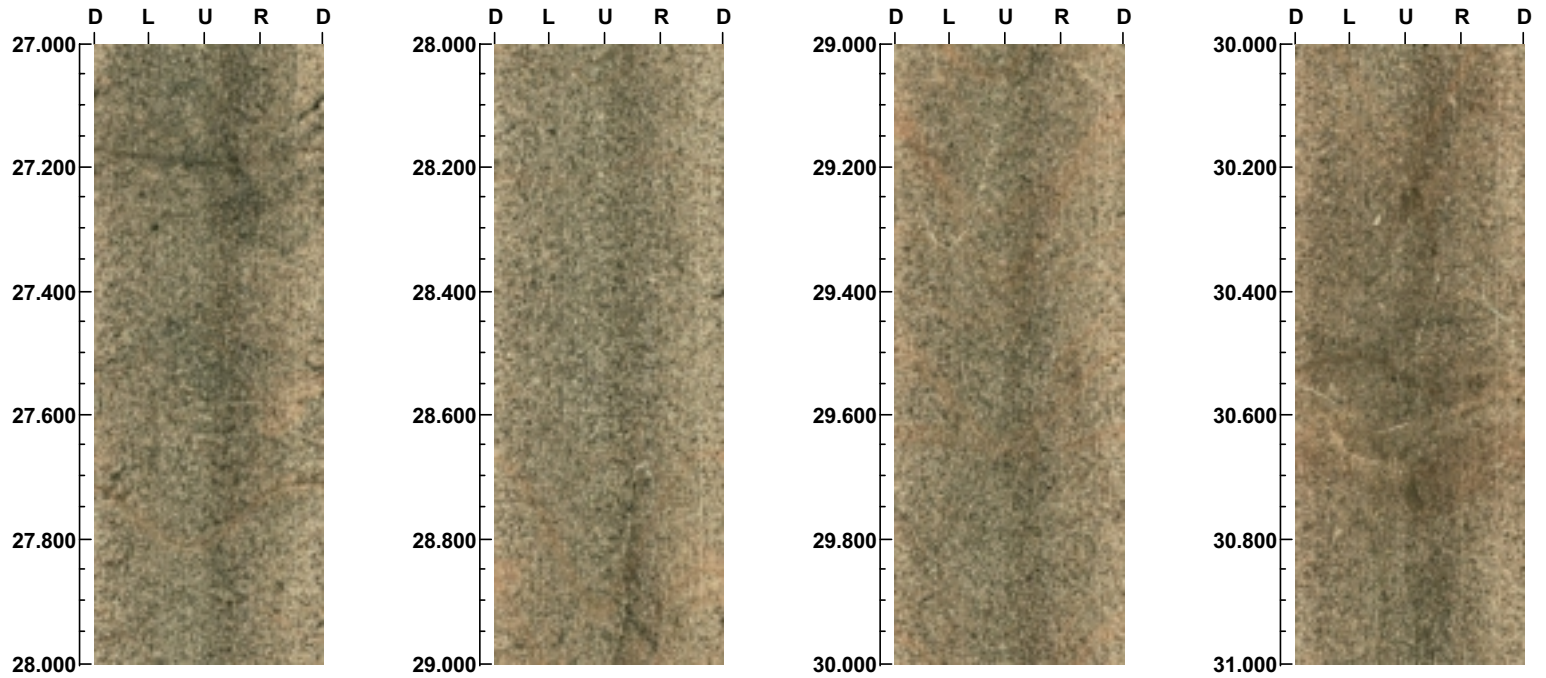

178

( 5 / 47 )

Scale: 1/10      Aspect ratio: 89 %



Project name: HSH03  
Bore hole No.: HSH03

Azimuth: 0      Inclination: -90

Depth range: 31.000 - 35.000 m

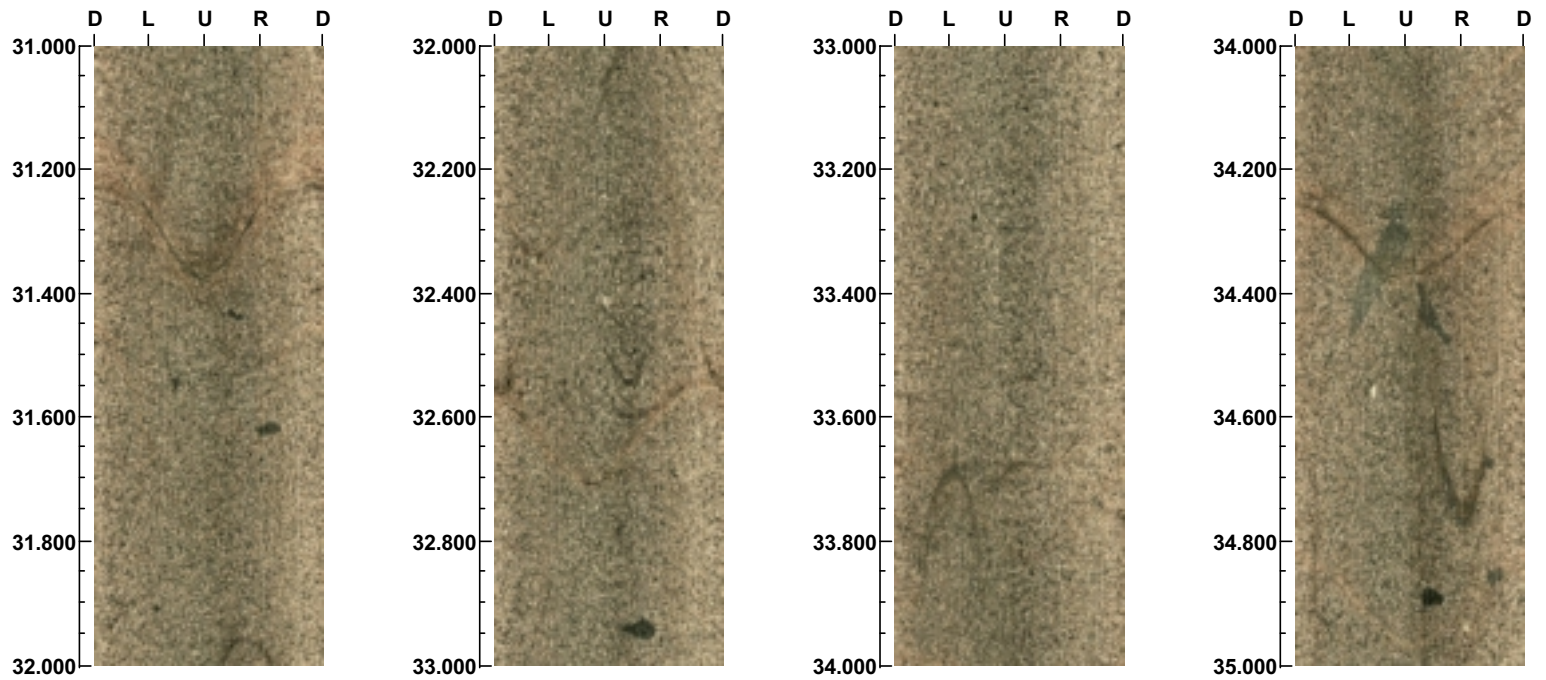

179

Project name: HSH03  
Bore hole No.: HSH03

Azimuth: 0      Inclination: -90

Depth range: 35.000 - 39.000 m

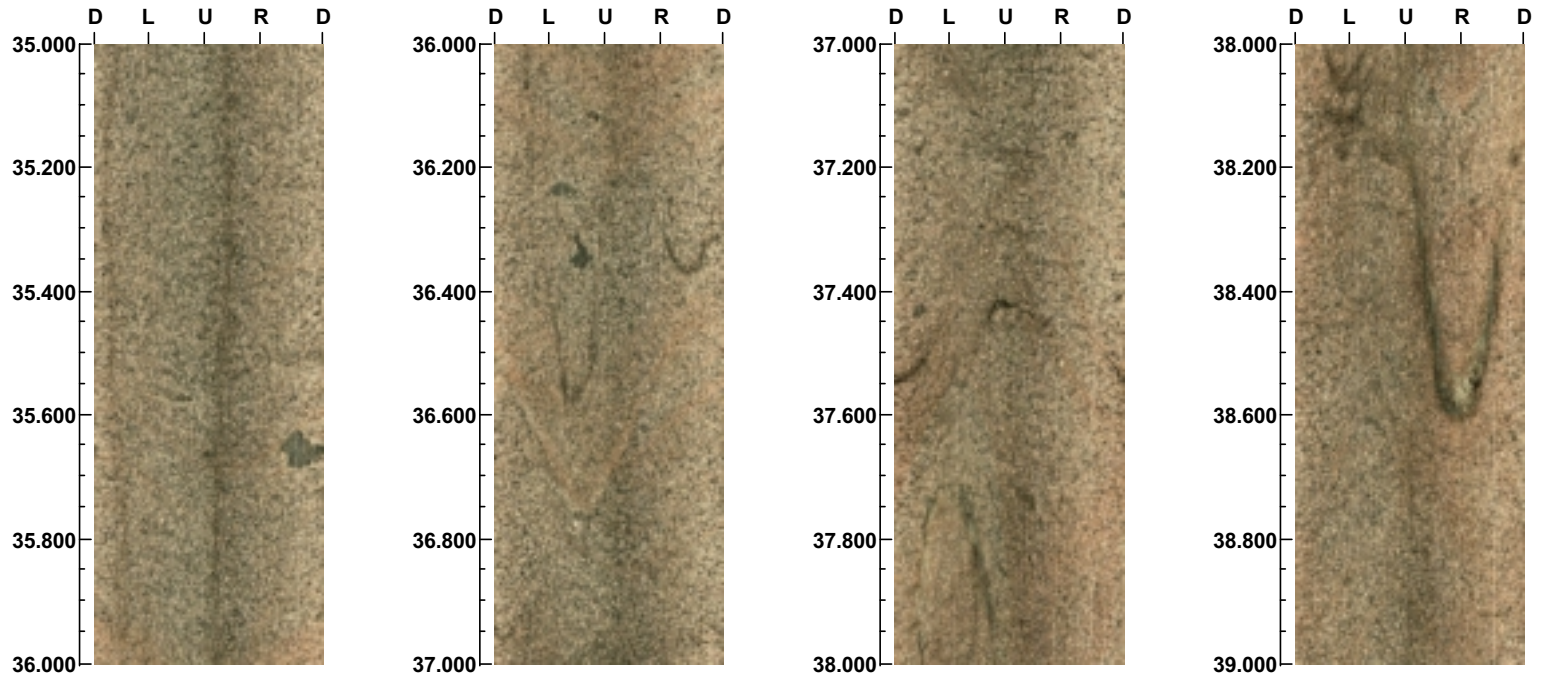

180

( 7 / 47 )

Scale: 1/10      Aspect ratio: 89 %

Project name: HSH03  
Bore hole No.: HSH03

Azimuth: 0      Inclination: -90

Depth range: 39.000 - 43.000 m

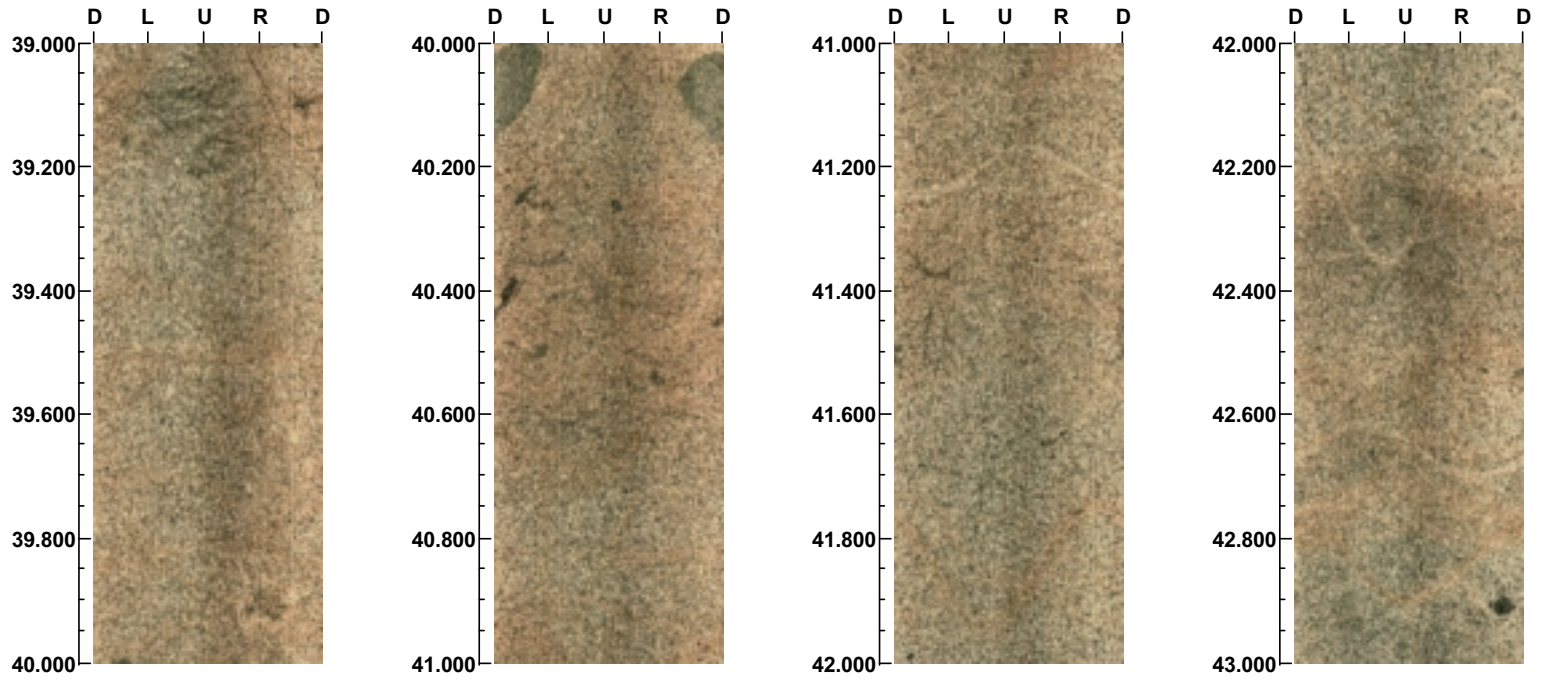

181

Project name: HSH03  
Bore hole No.: HSH03

Azimuth: 0      Inclination: -90

Depth range: 43.000 - 47.000 m

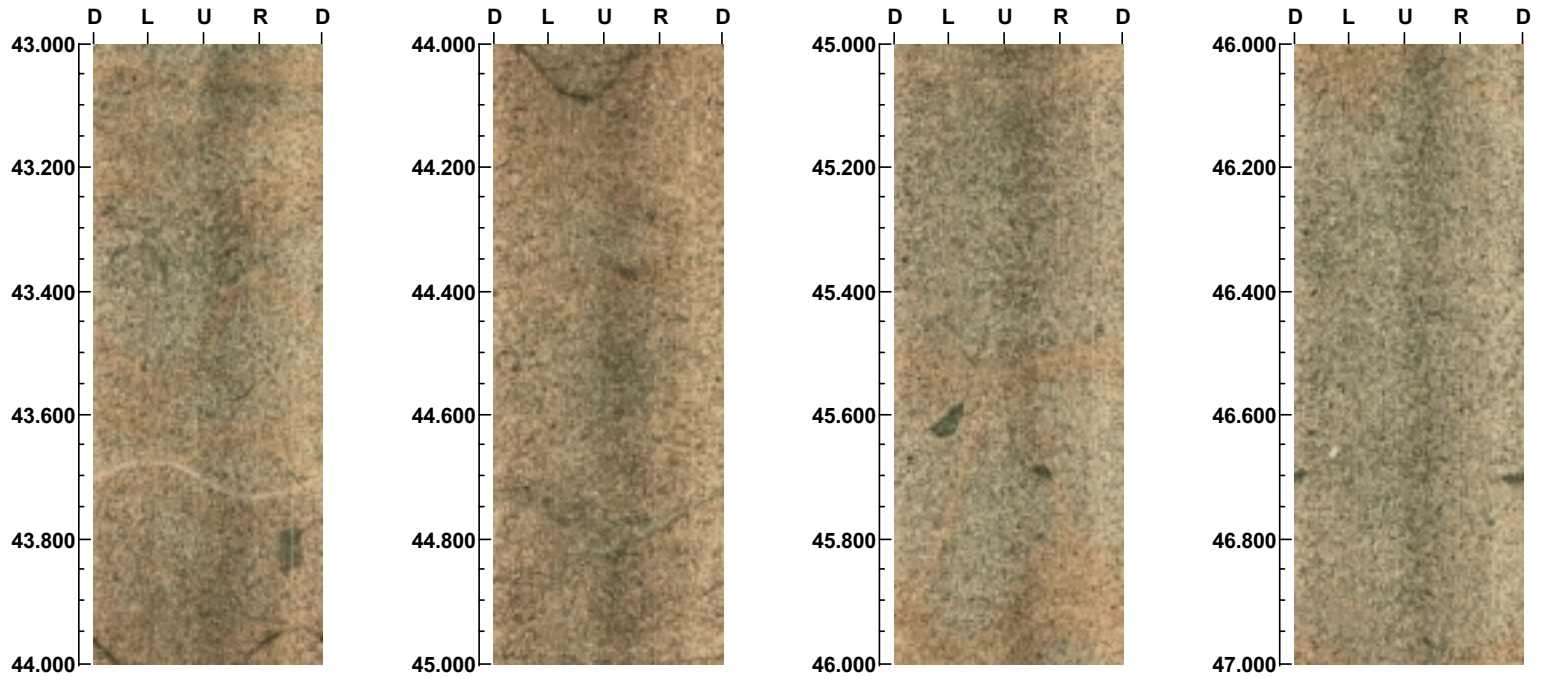



Project name: HSH03  
Bore hole No.: HSH03

Azimuth: 0      Inclination: -90

Depth range: 47.000 - 51.000 m

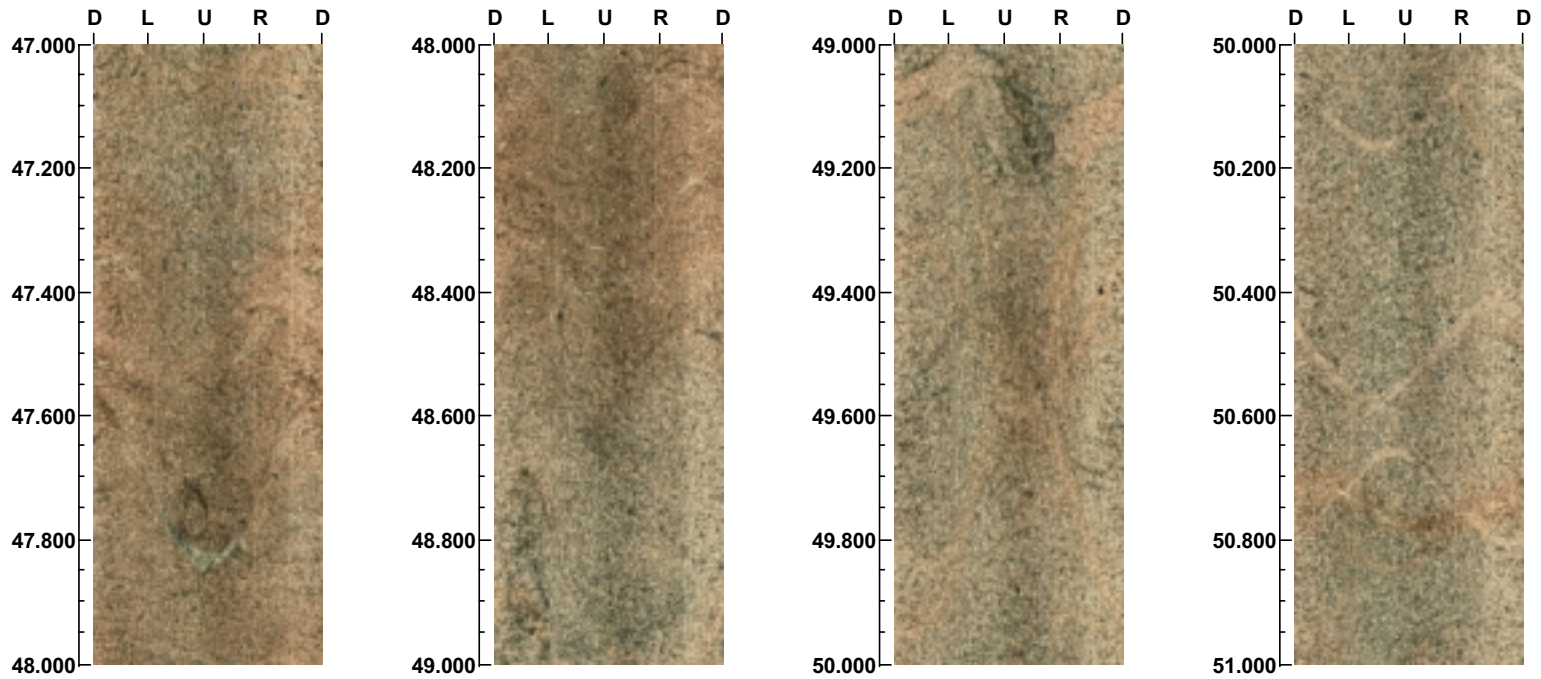

Project name: HSH03  
Bore hole No.: HSH03

Azimuth: 0      Inclination: -90

Depth range: 51.000 - 55.000 m

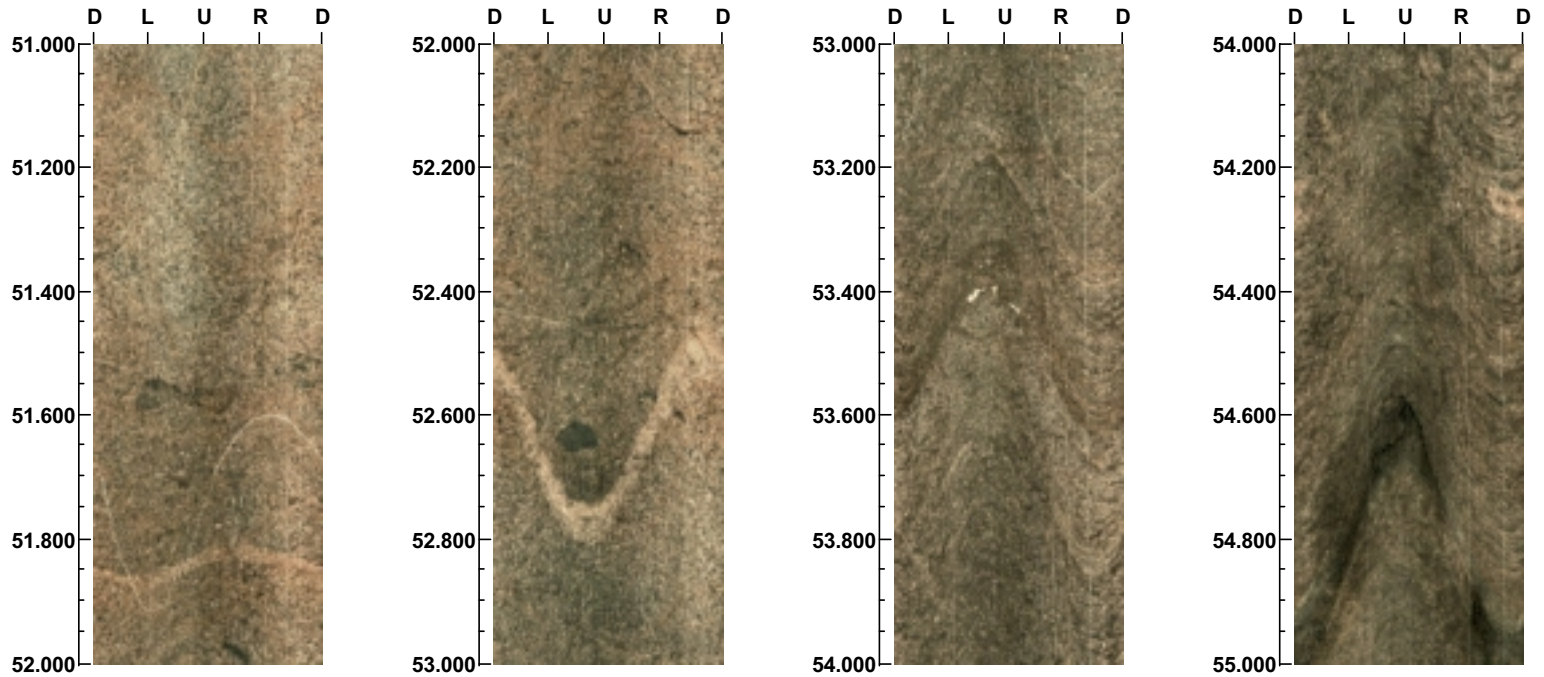

Project name: HSH03  
Bore hole No.: HSH03

Azimuth: 0      Inclination: -90

Depth range: 55.000 - 59.000 m

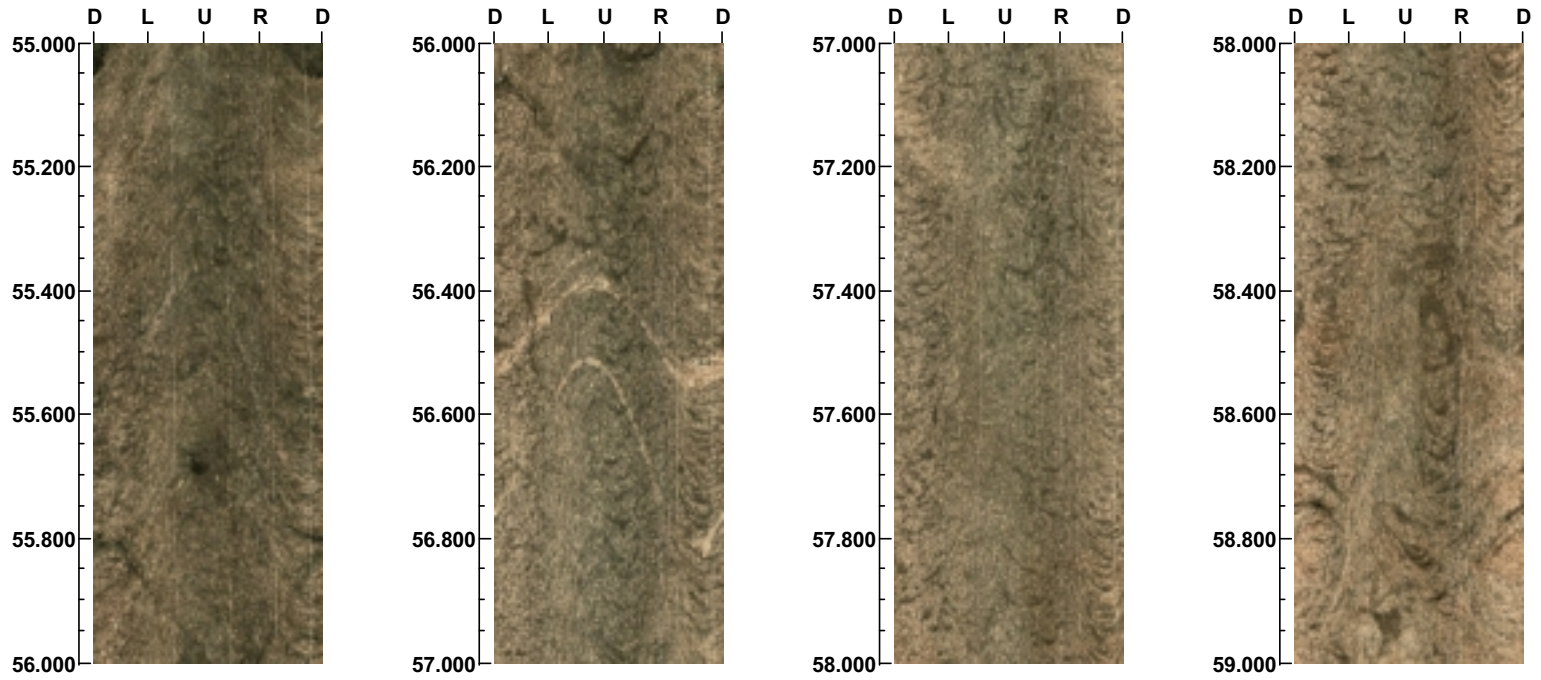

185



Project name: HSH03  
Bore hole No.: HSH03

Azimuth: 0      Inclination: -90

Depth range: 59.000 - 63.000 m

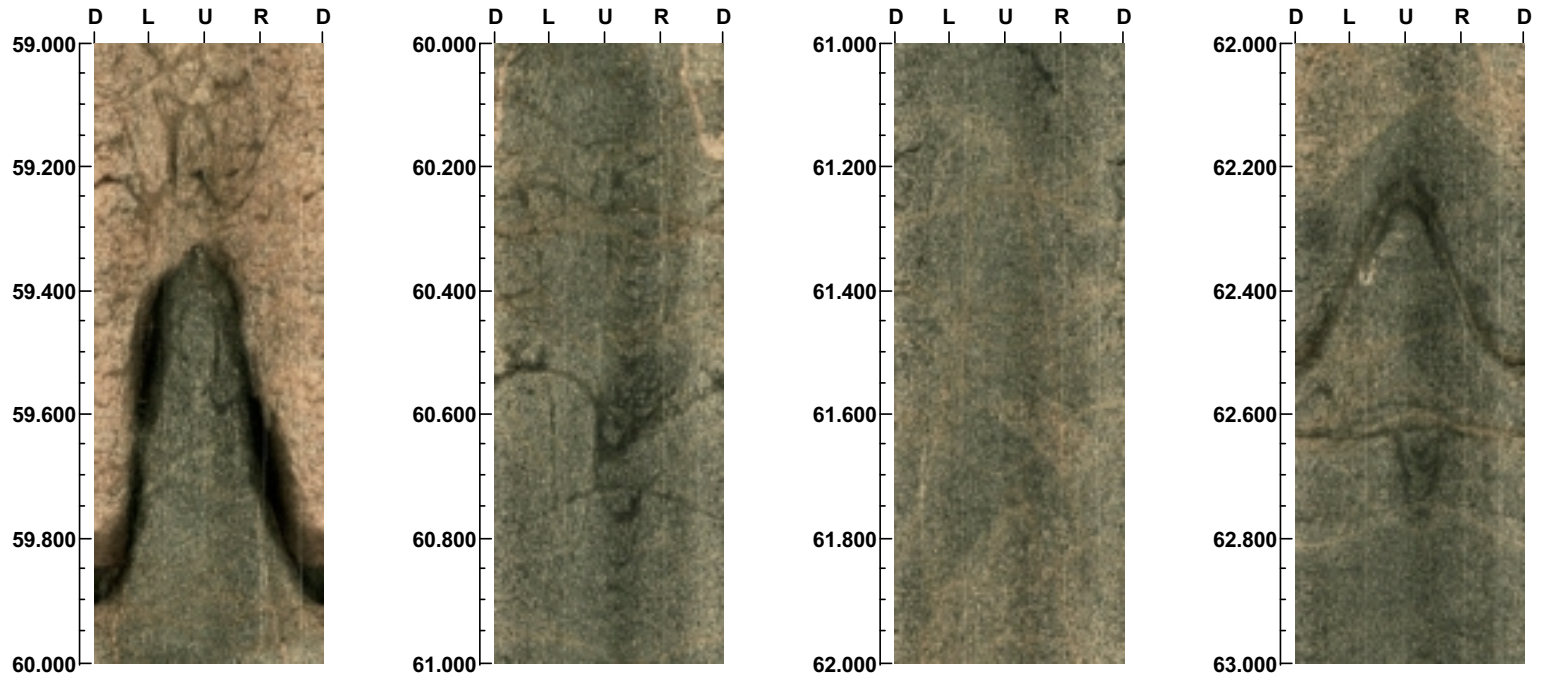

Project name: HSH03  
Bore hole No.: HSH03

Azimuth: 0      Inclination: -90

Depth range: 63.000 - 67.000 m

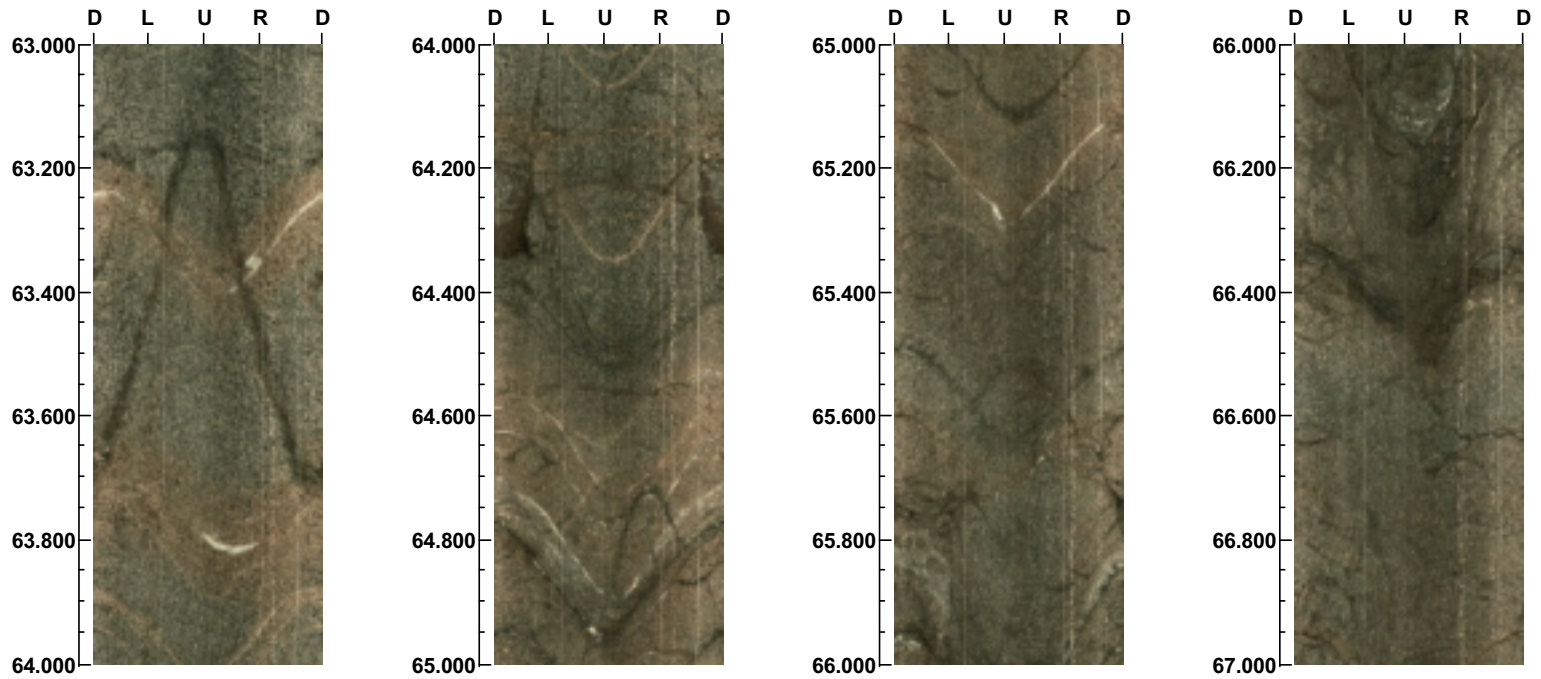

Project name: HSH03  
Bore hole No.: HSH03

Azimuth: 0      Inclination: -90

Depth range: 67.000 - 71.000 m

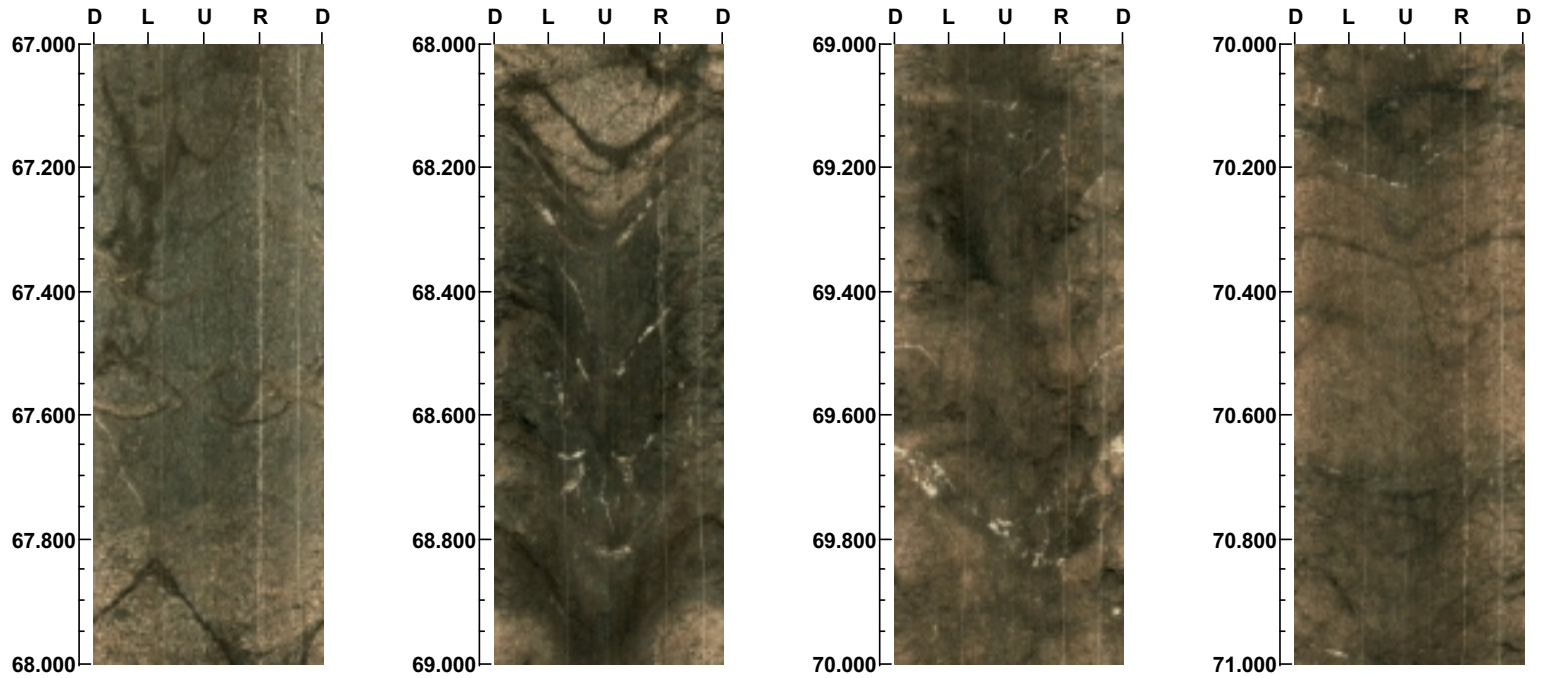

188

( 15 / 47 )

Scale: 1/10      Aspect ratio: 89 %

Project name: HSH03  
Bore hole No.: HSH03

Azimuth: 0      Inclination: -90

Depth range: 71.000 - 75.000 m

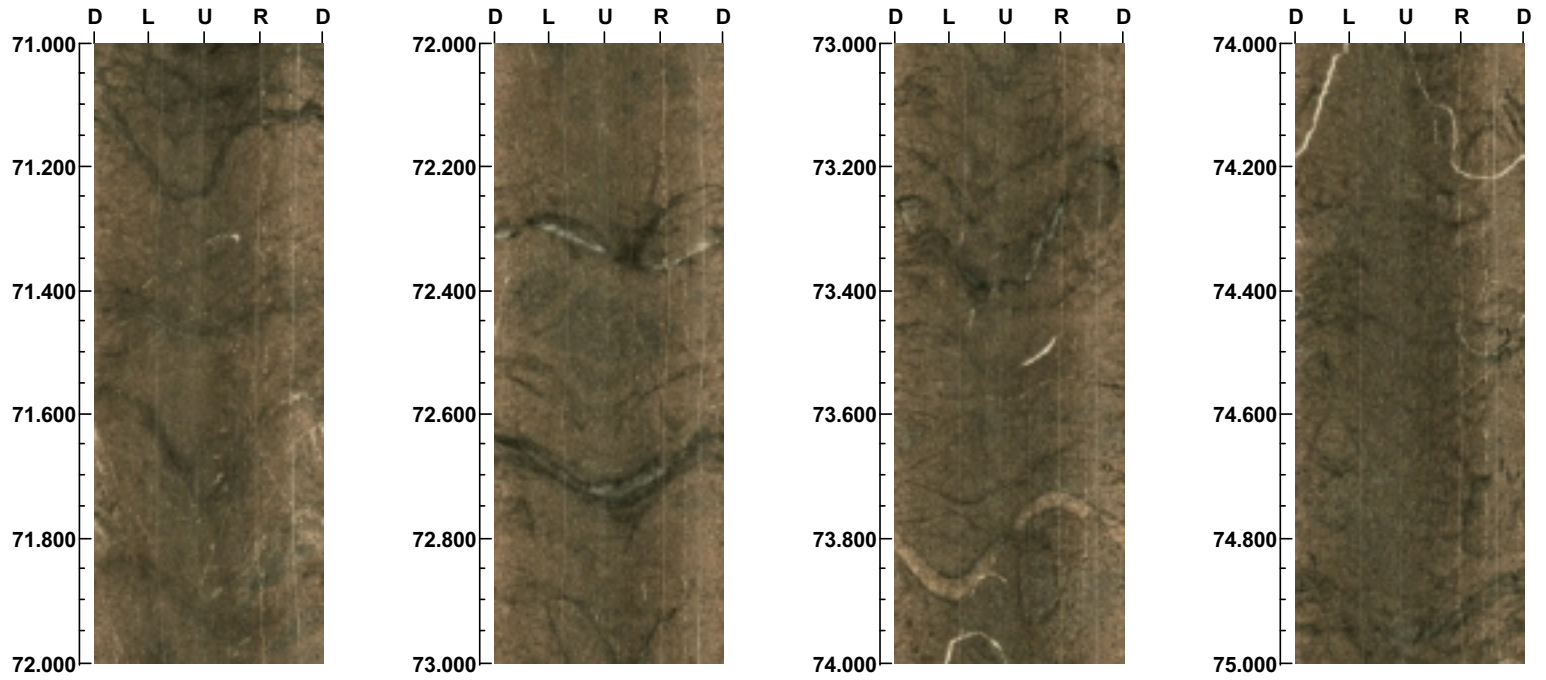

Project name: HSH03  
Bore hole No.: HSH03

Azimuth: 0      Inclination: -90

Depth range: 75.000 - 79.000 m

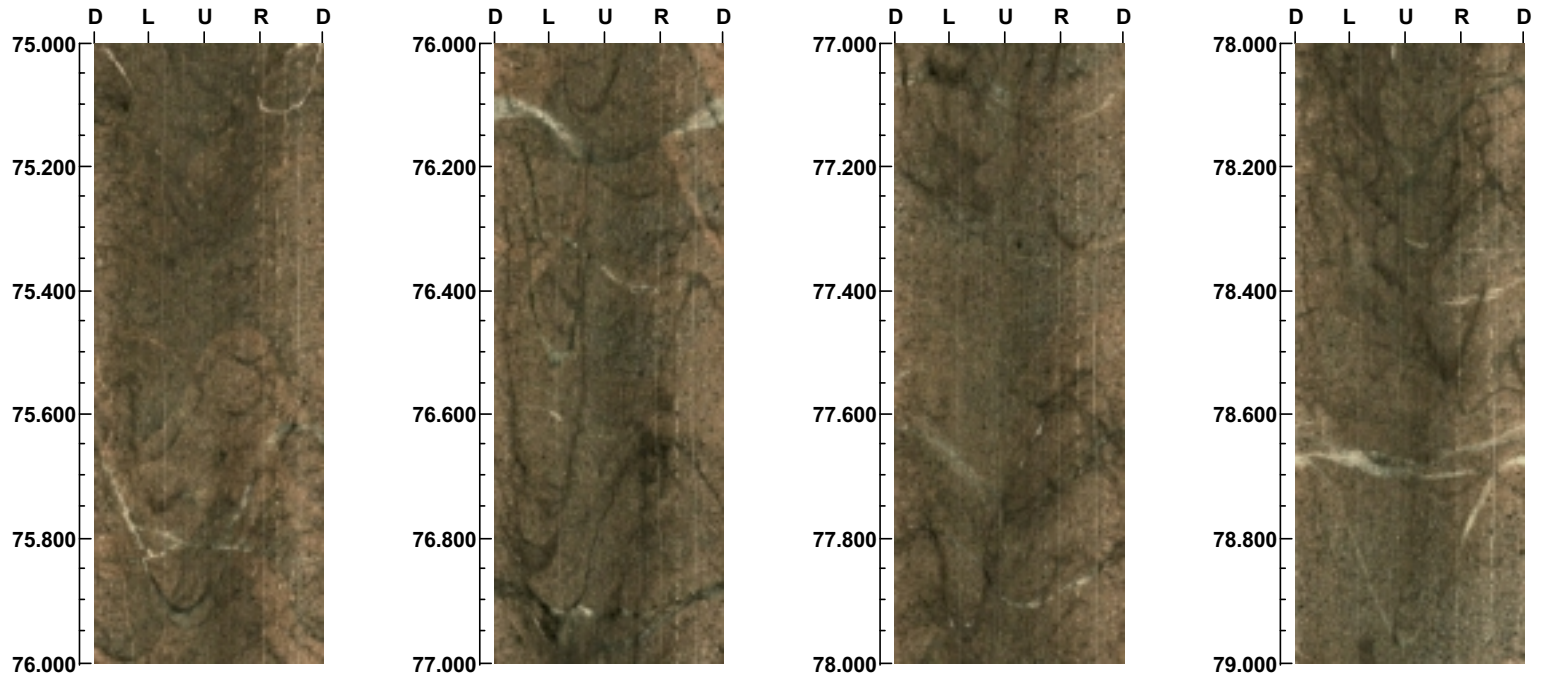

190



Project name: HSH03  
Bore hole No.: HSH03

Azimuth: 0      Inclination: -90

Depth range: 79.000 - 83.000 m

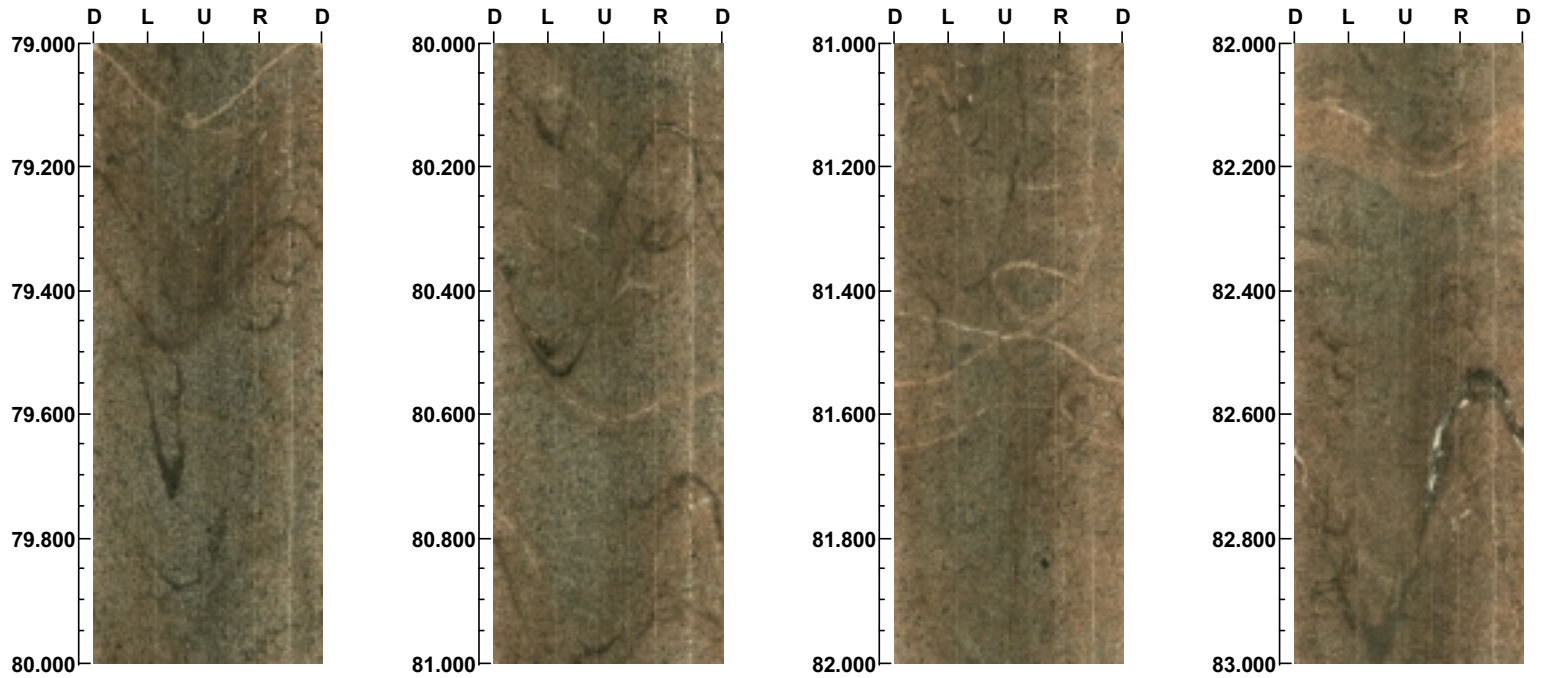

191

( 18 / 47 )

Scale: 1/10      Aspect ratio: 89 %



Project name: HSH03  
Bore hole No.: HSH03

Azimuth: 0      Inclination: -90

Depth range: 83.000 - 87.000 m

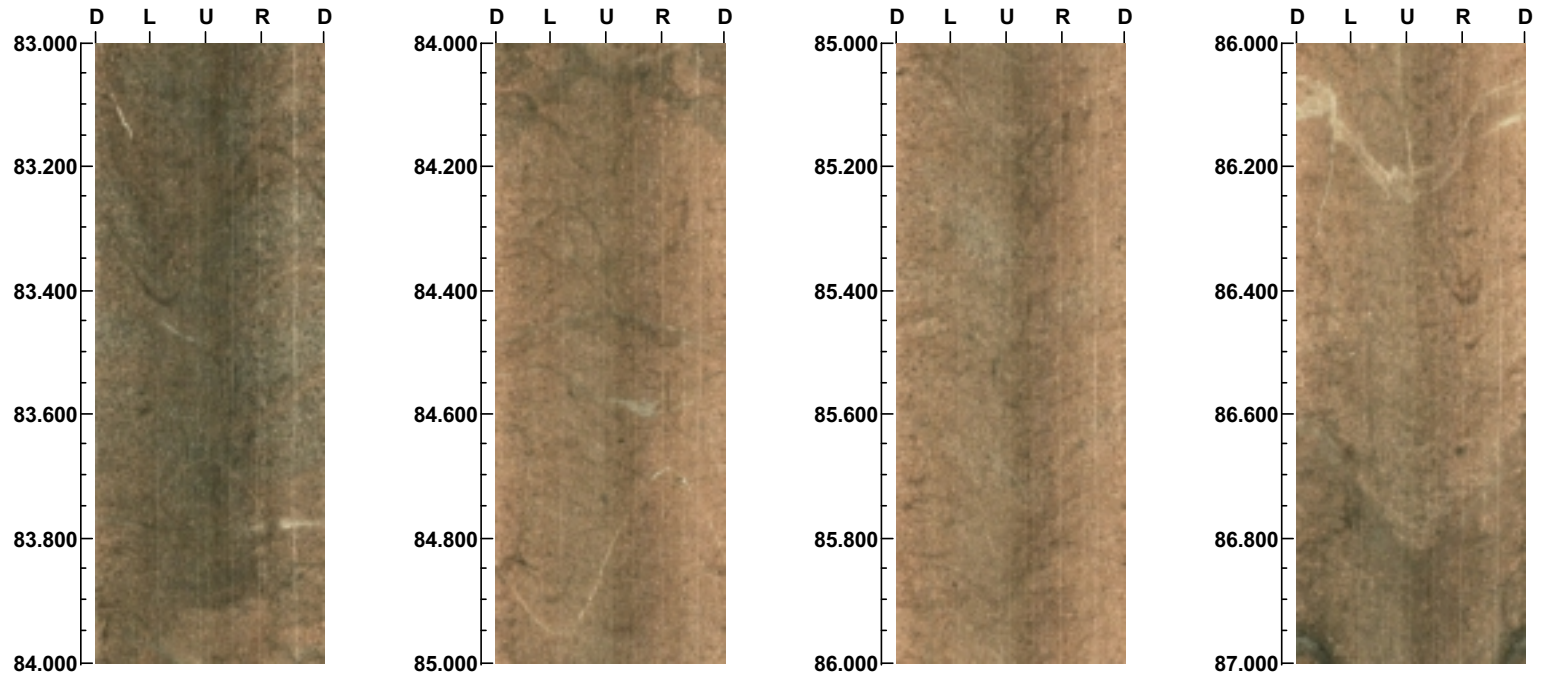

Project name: HSH03  
Bore hole No.: HSH03

Azimuth: 0      Inclination: -90

Depth range: 87.000 - 91.000 m

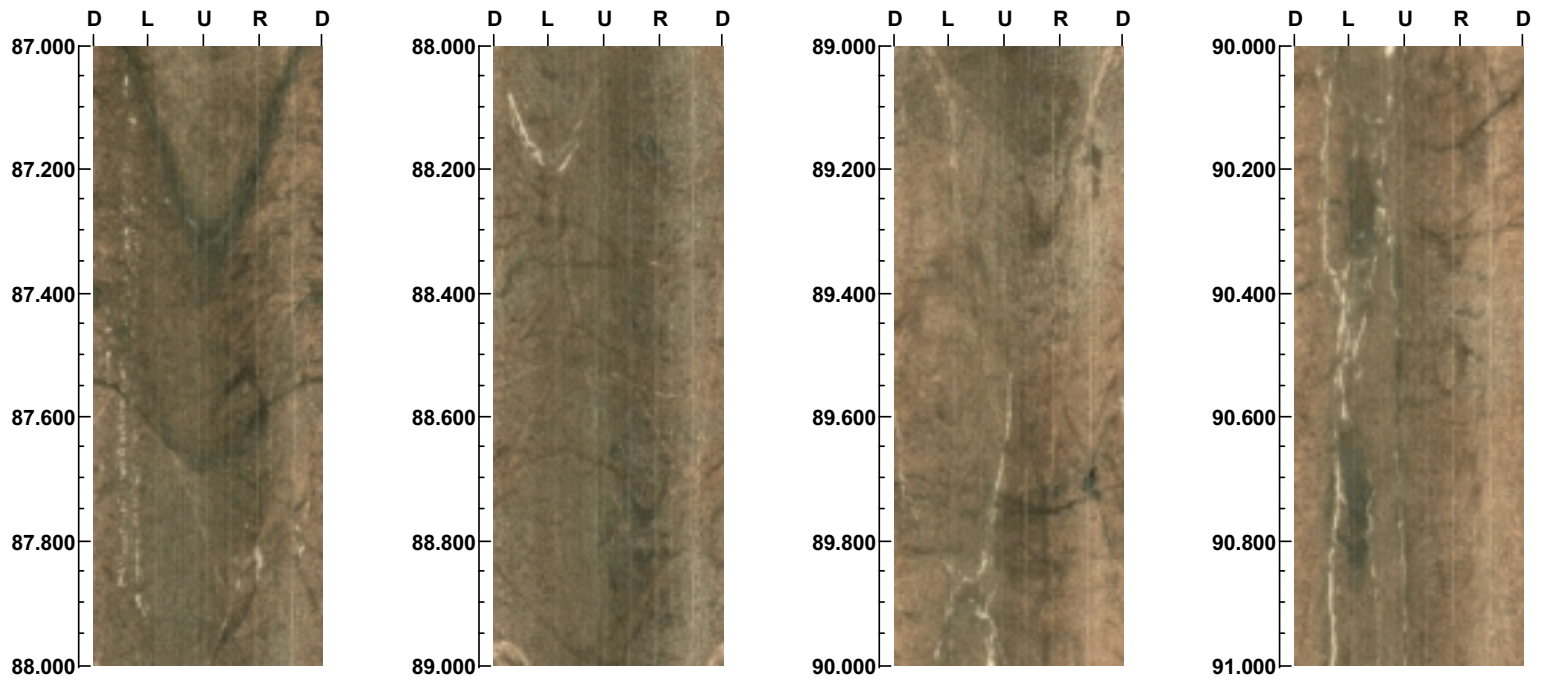

Project name: HSH03  
Bore hole No.: HSH03

Azimuth: 0      Inclination: -90

Depth range: 91.000 - 95.000 m

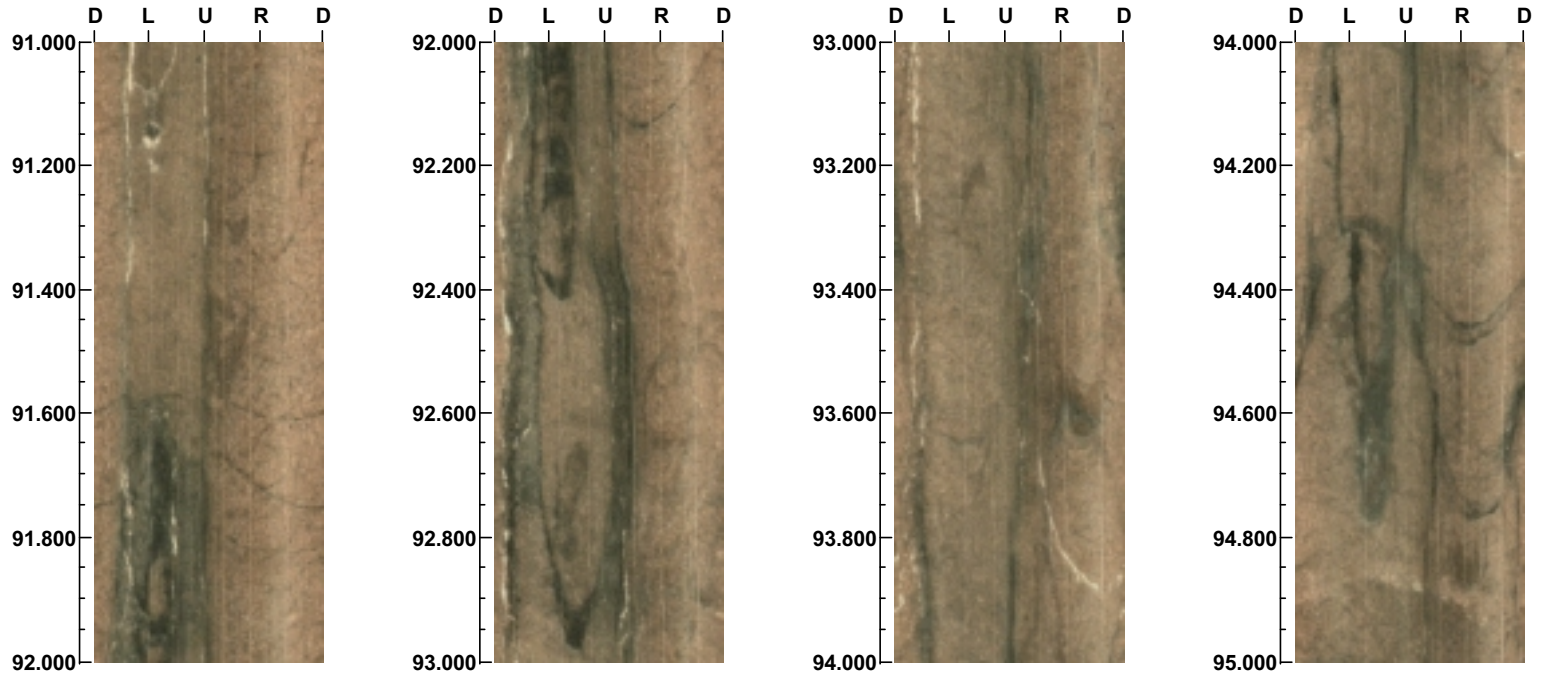

Project name: HSH03  
Bore hole No.: HSH03

Azimuth: 0      Inclination: -90

Depth range: 95.000 - 99.000 m

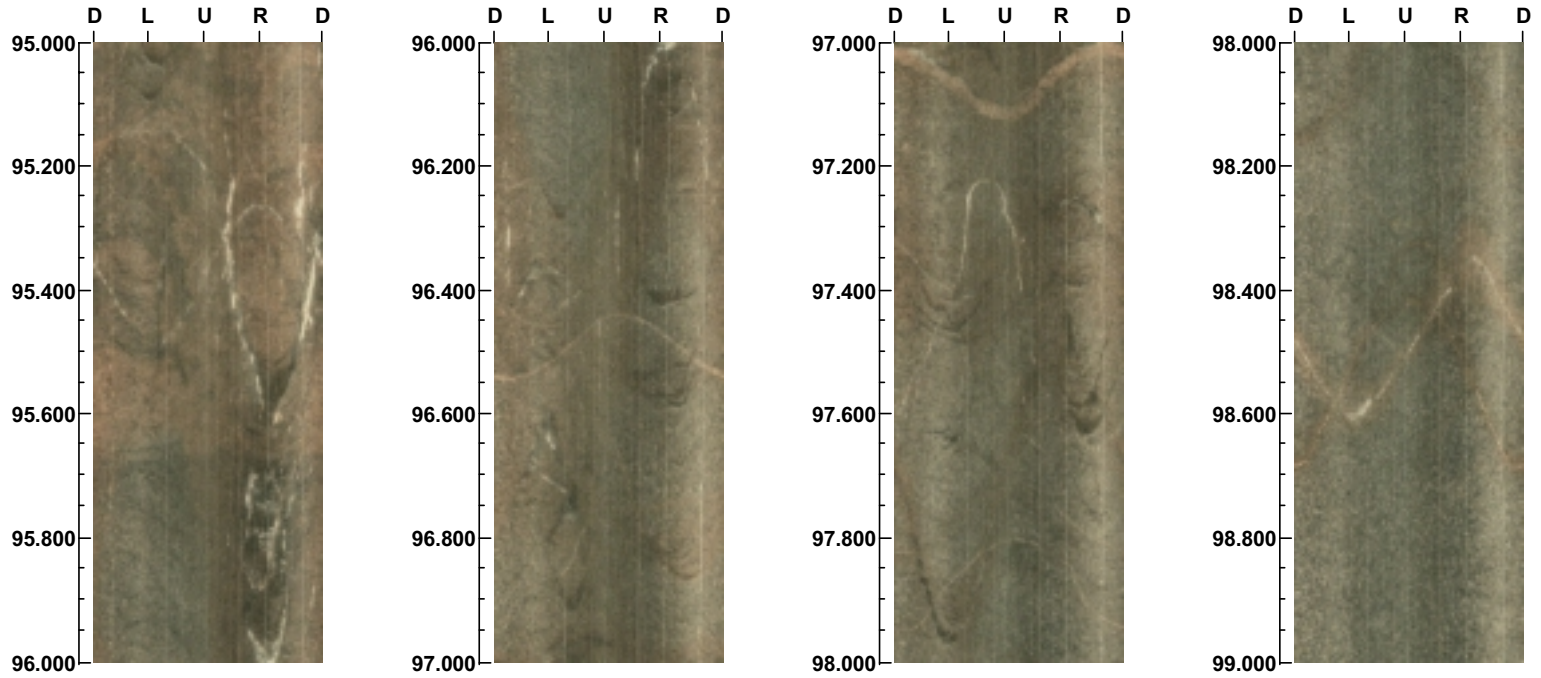

195

( 22 / 47 )

Scale: 1/10      Aspect ratio: 89 %

Project name: HSH03  
Bore hole No.: HSH03

Azimuth: 0      Inclination: -90

Depth range: 99.000 - 103.000 m

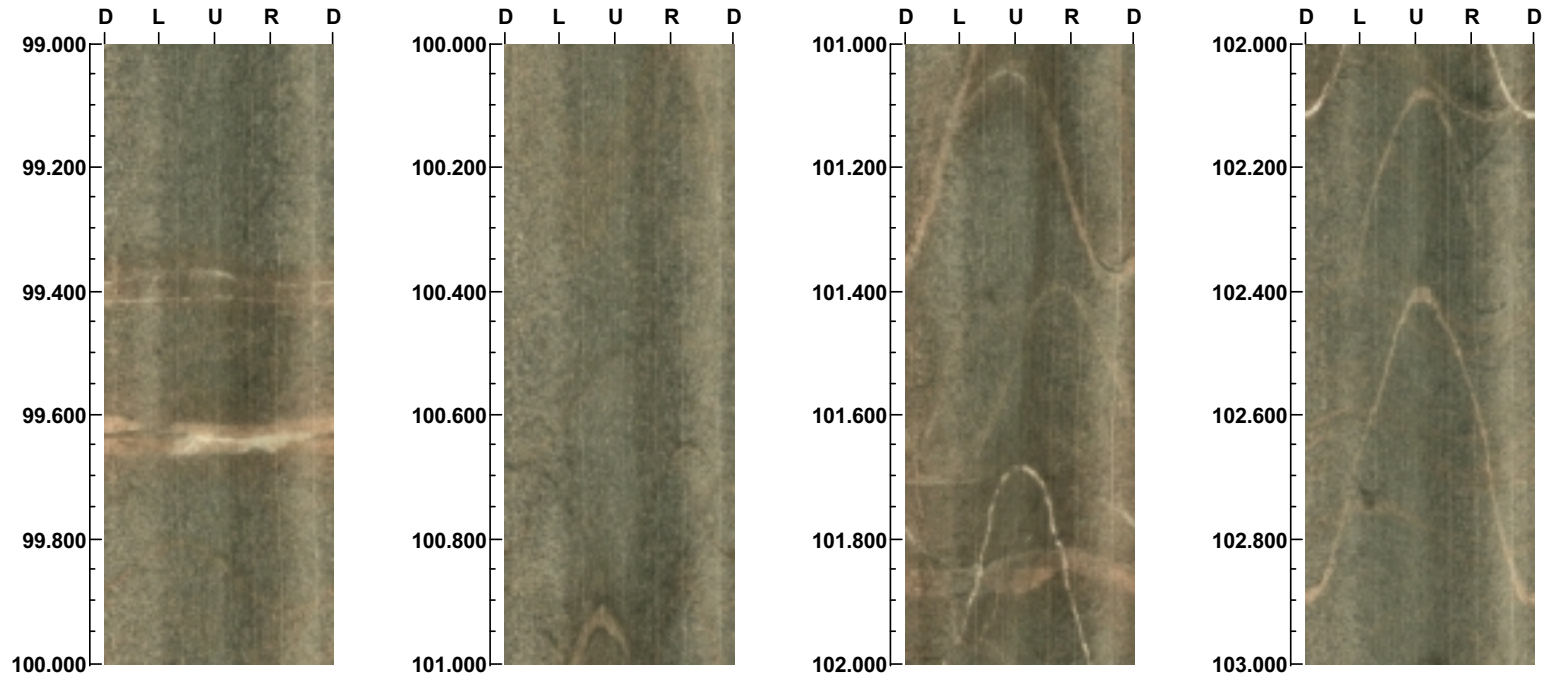

Project name: HSH03  
Bore hole No.: HSH03

Azimuth: 0      Inclination: -90

Depth range: 103.000 - 107.000 m

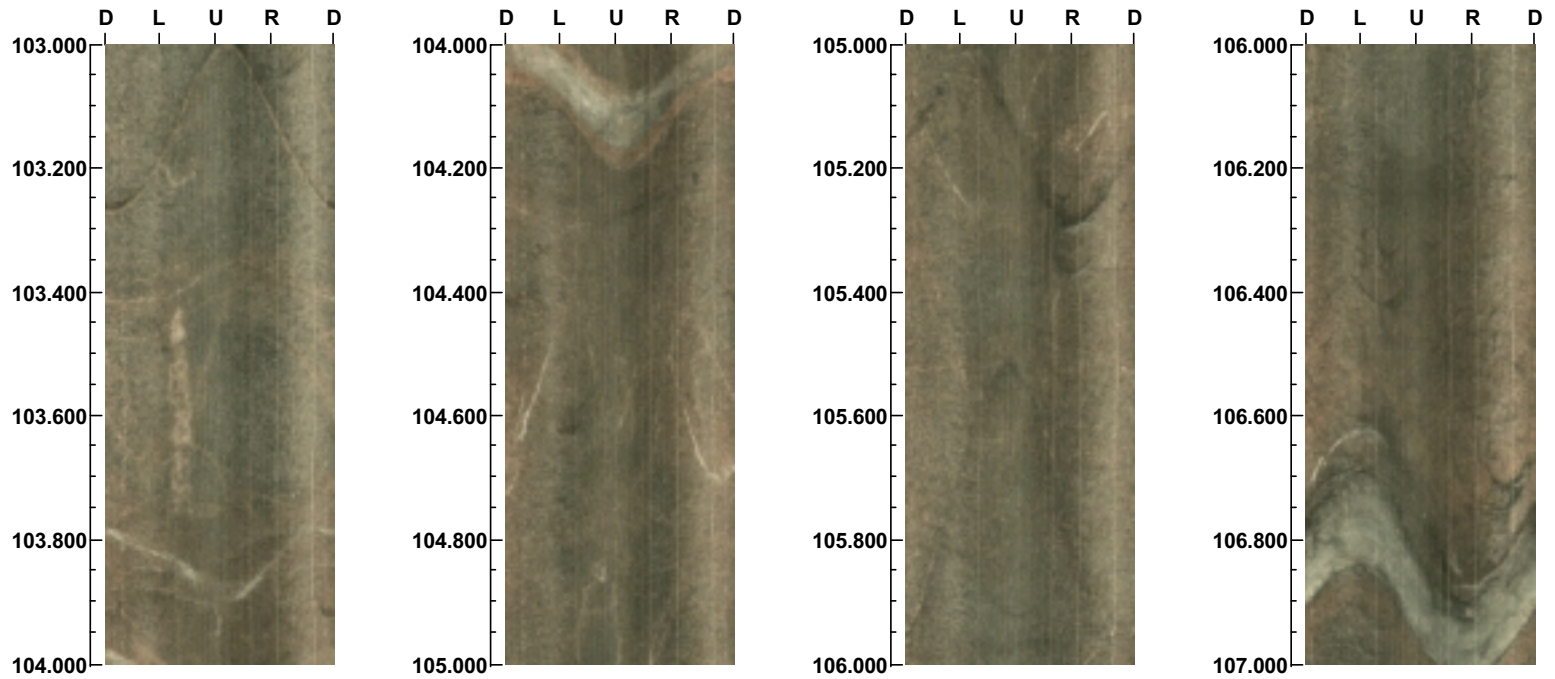

197



Project name: HSH03  
Bore hole No.: HSH03

Azimuth: 0      Inclination: -90

Depth range: 107.000 - 111.000 m

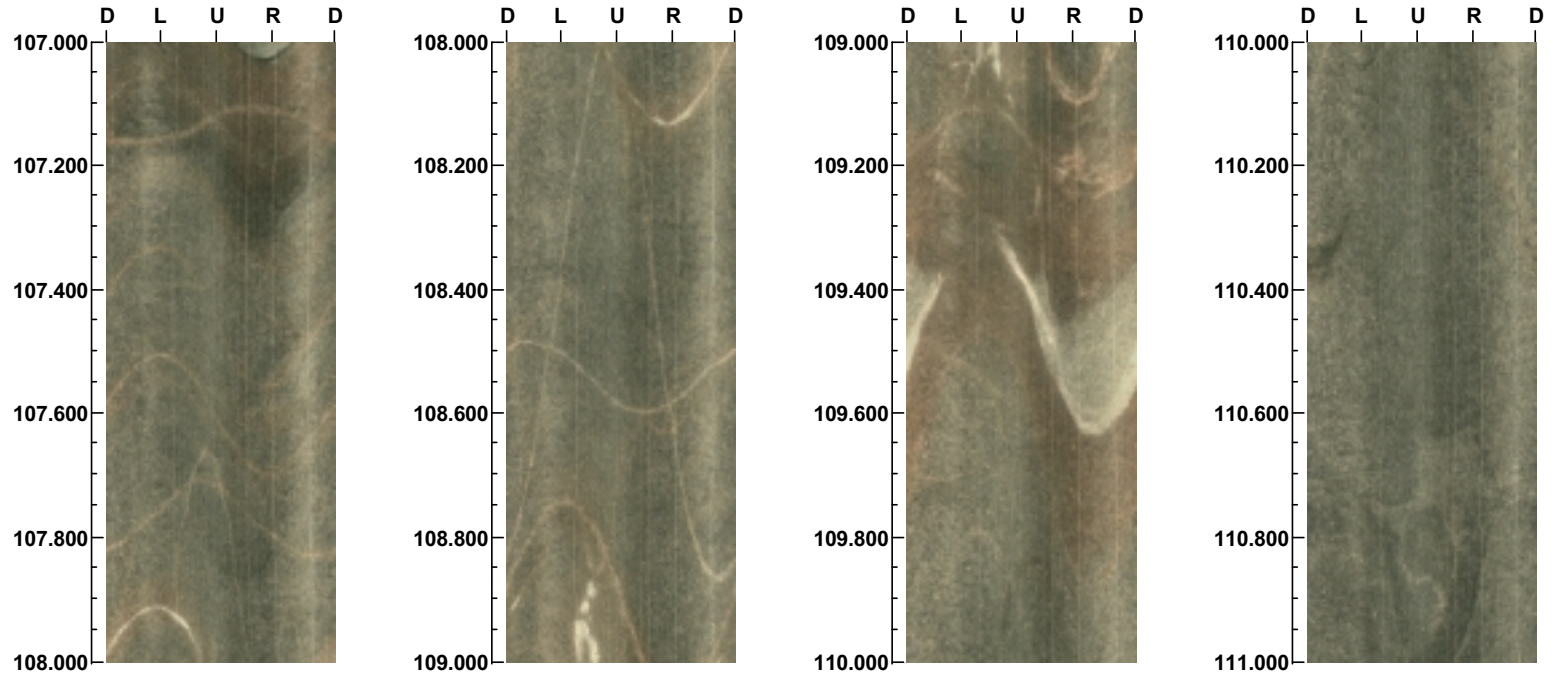

198

( 25 / 47 )

Scale: 1/10      Aspect ratio: 89 %

Project name: HSH03  
Bore hole No.: HSH03

Azimuth: 0      Inclination: -90

Depth range: 111.000 - 115.000 m

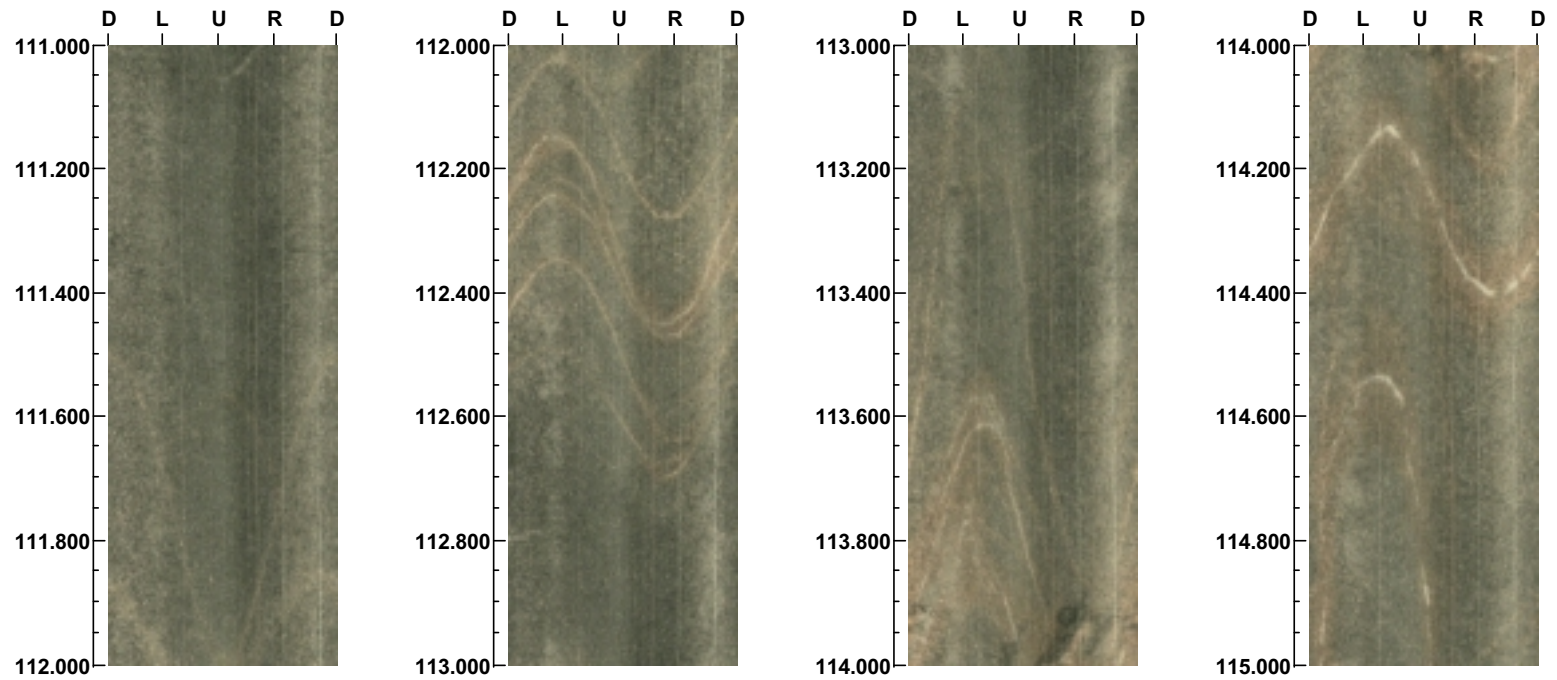

Project name: HSH03  
Bore hole No.: HSH03

Azimuth: 0      Inclination: -90

Depth range: 115.000 - 119.000 m

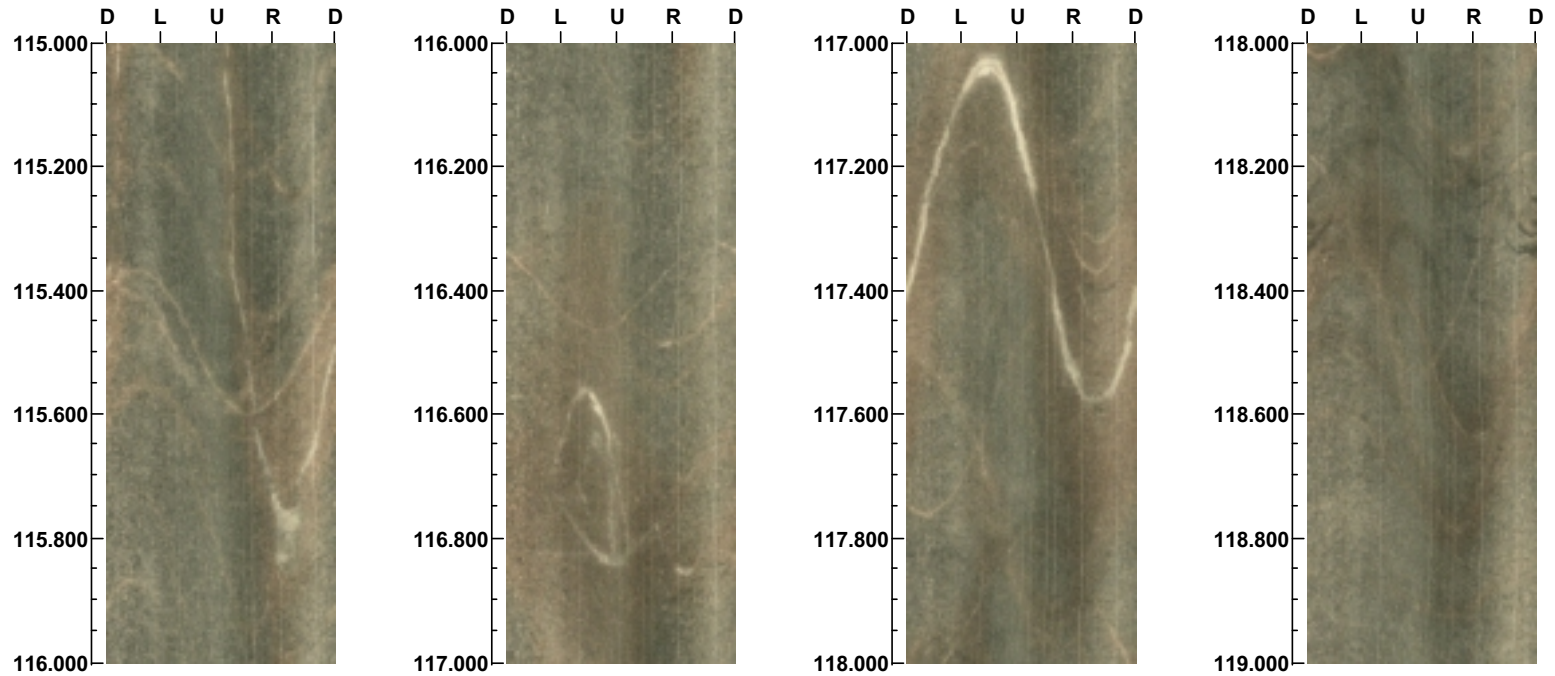

200

Project name: HSH03  
Bore hole No.: HSH03

Azimuth: 0      Inclination: -90

Depth range: 119.000 - 123.000 m

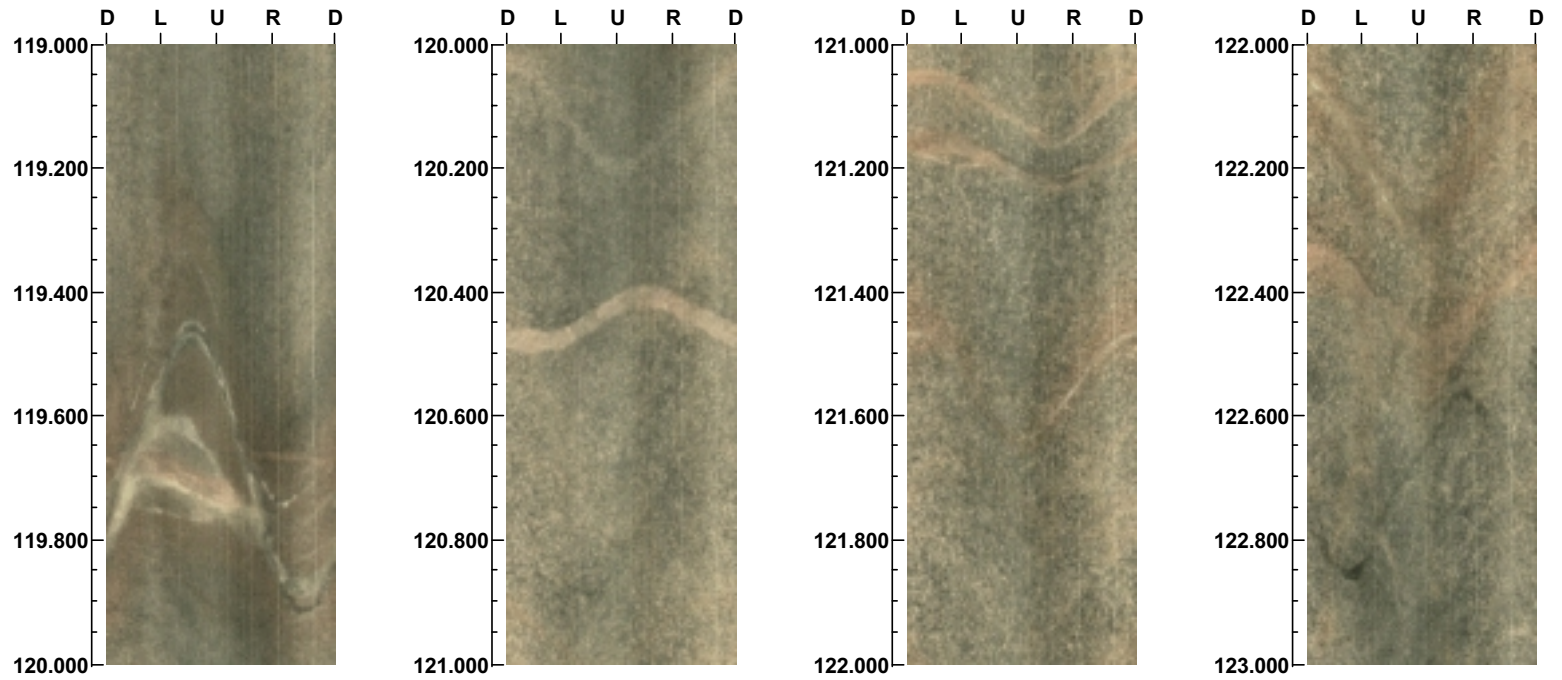

201

Project name: HSH03  
Bore hole No.: HSH03

Azimuth: 0      Inclination: -90

Depth range: 123.000 - 127.000 m

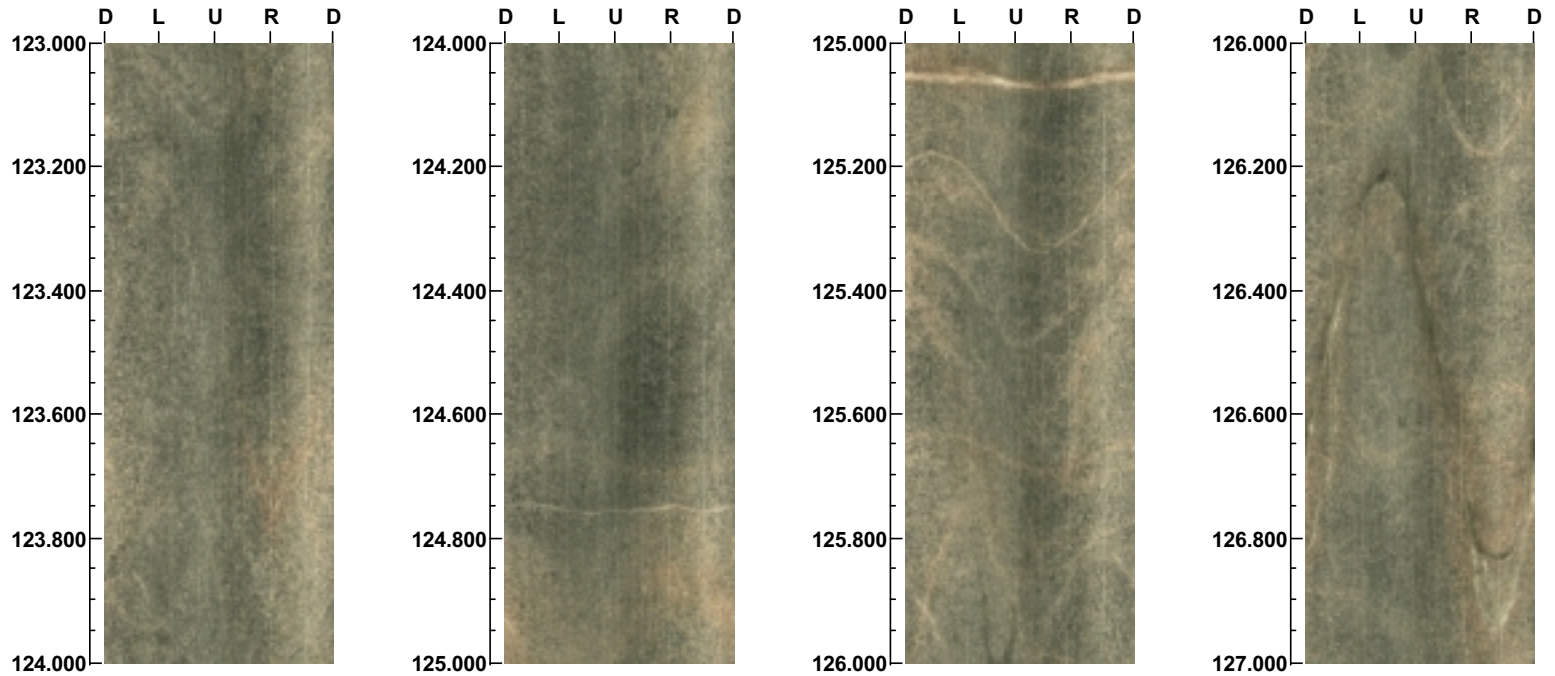

202

Project name: HSH03  
Bore hole No.: HSH03

Azimuth: 0      Inclination: -90

Depth range: 127.000 - 131.000 m

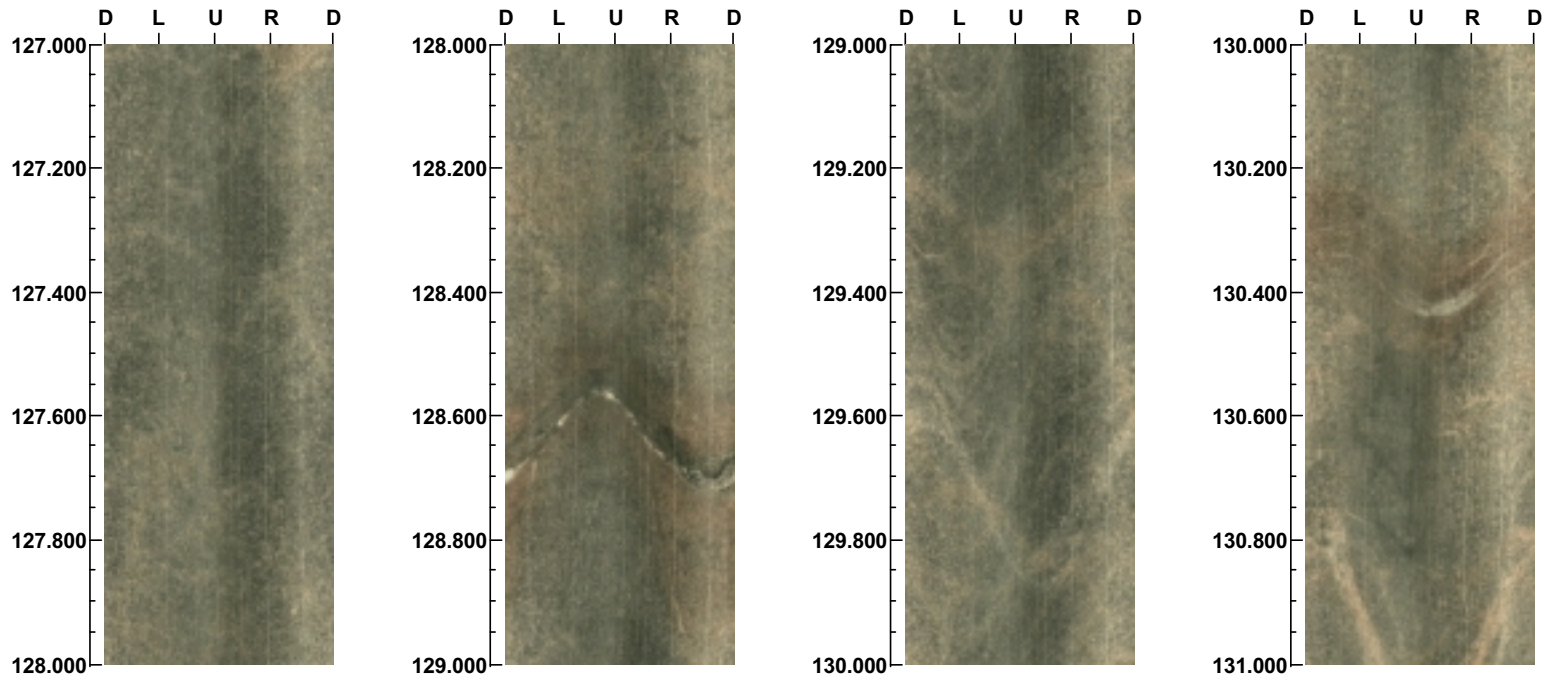

203



Project name: HSH03  
Bore hole No.: HSH03

Azimuth: 0      Inclination: -90

Depth range: 131.000 - 135.000 m

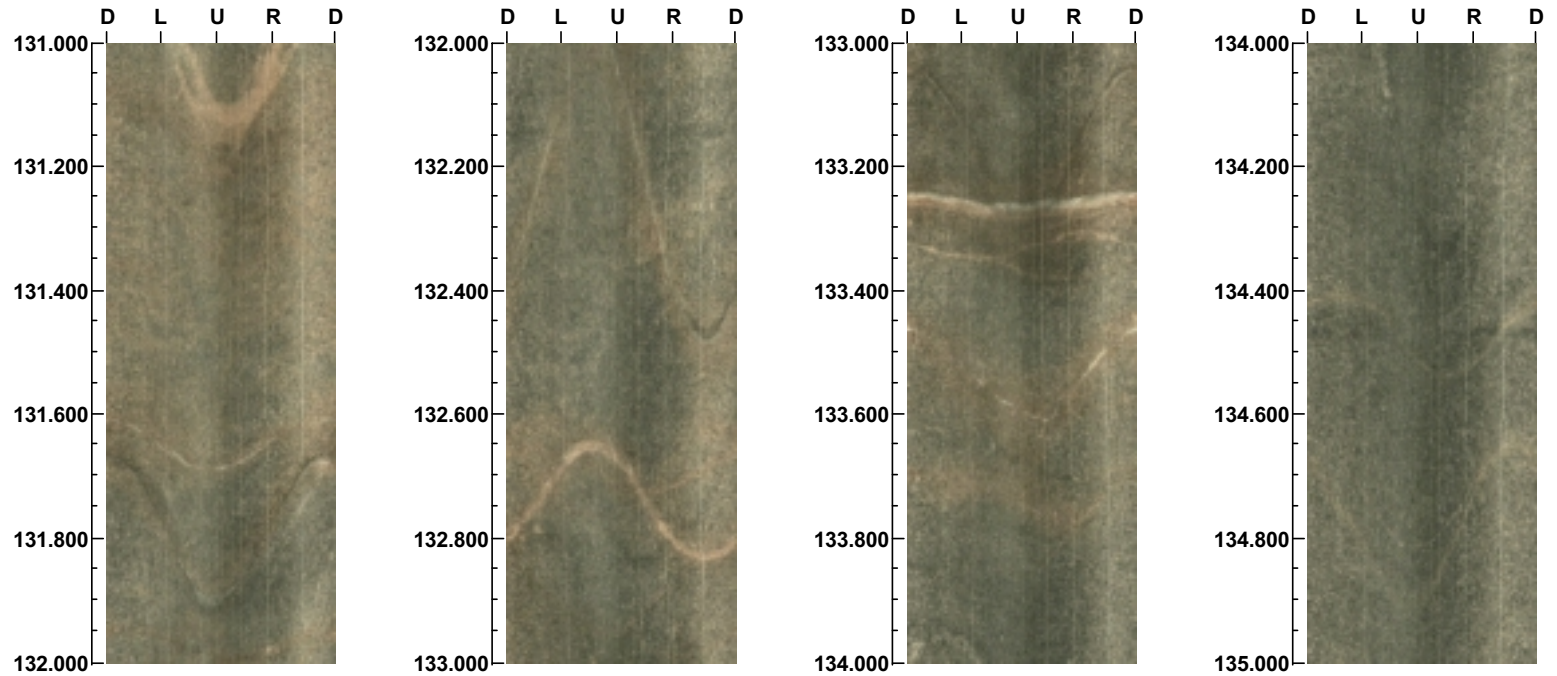

Project name: HSH03  
Bore hole No.: HSH03

Azimuth: 0      Inclination: -90

Depth range: 135.000 - 139.000 m

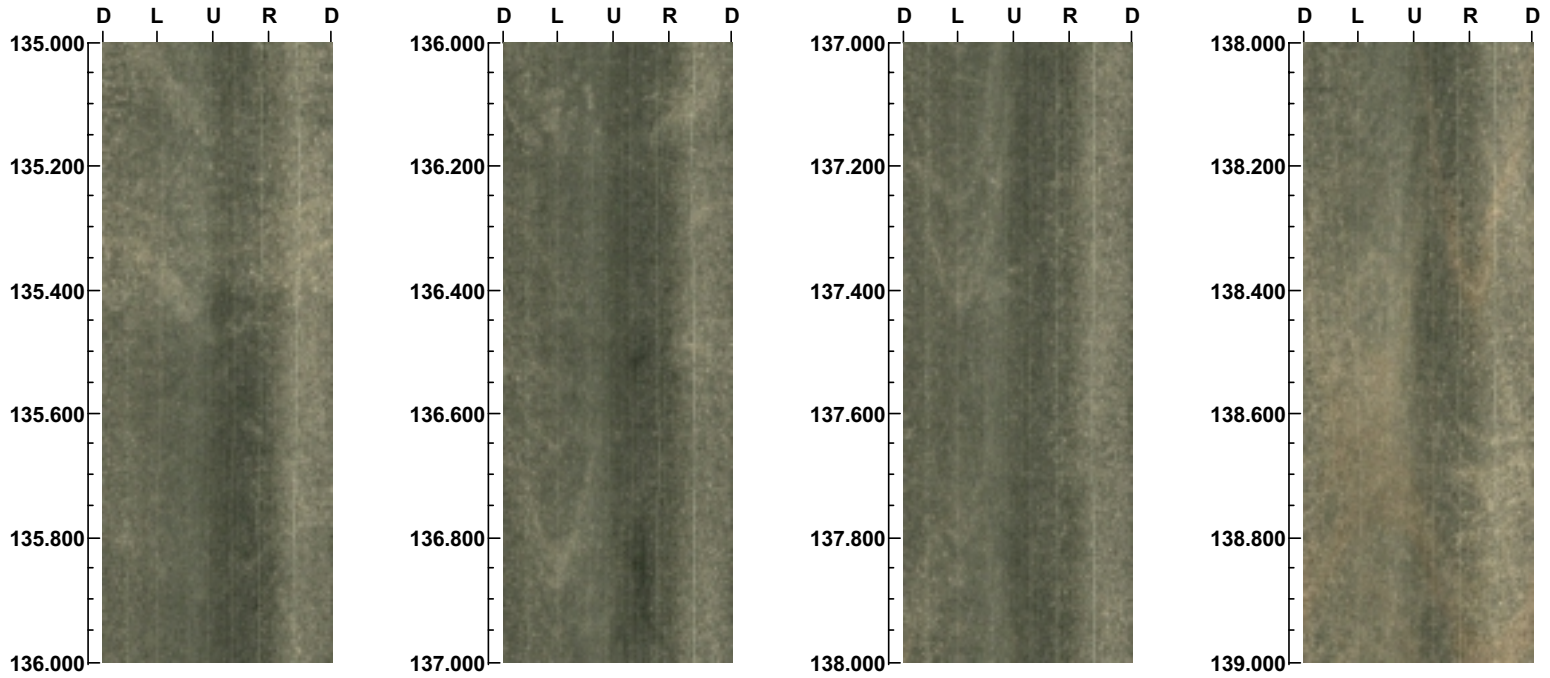

205

Project name: HSH03  
Bore hole No.: HSH03

Azimuth: 0      Inclination: -90

Depth range: 139.000 - 143.000 m

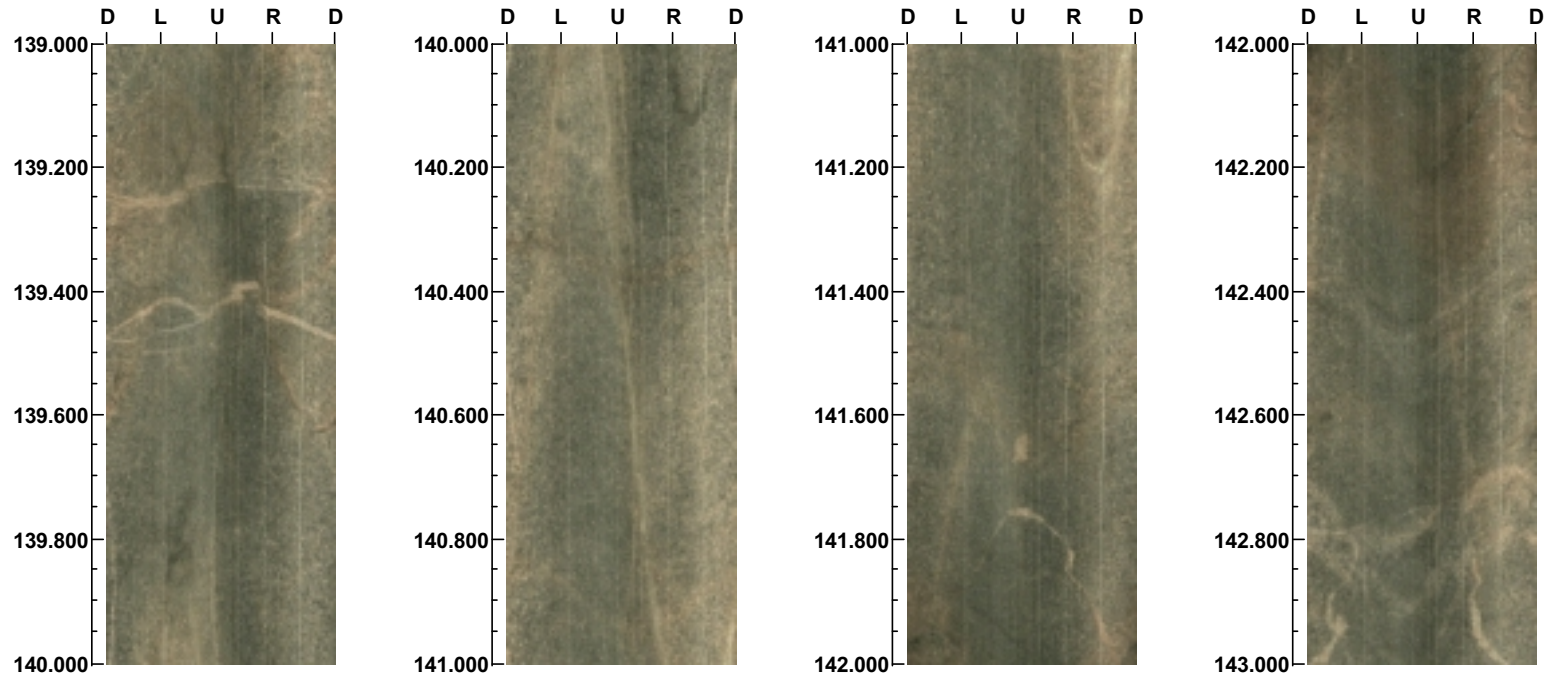

Project name: HSH03  
Bore hole No.: HSH03

Azimuth: 0      Inclination: -90

Depth range: 143.000 - 147.000 m

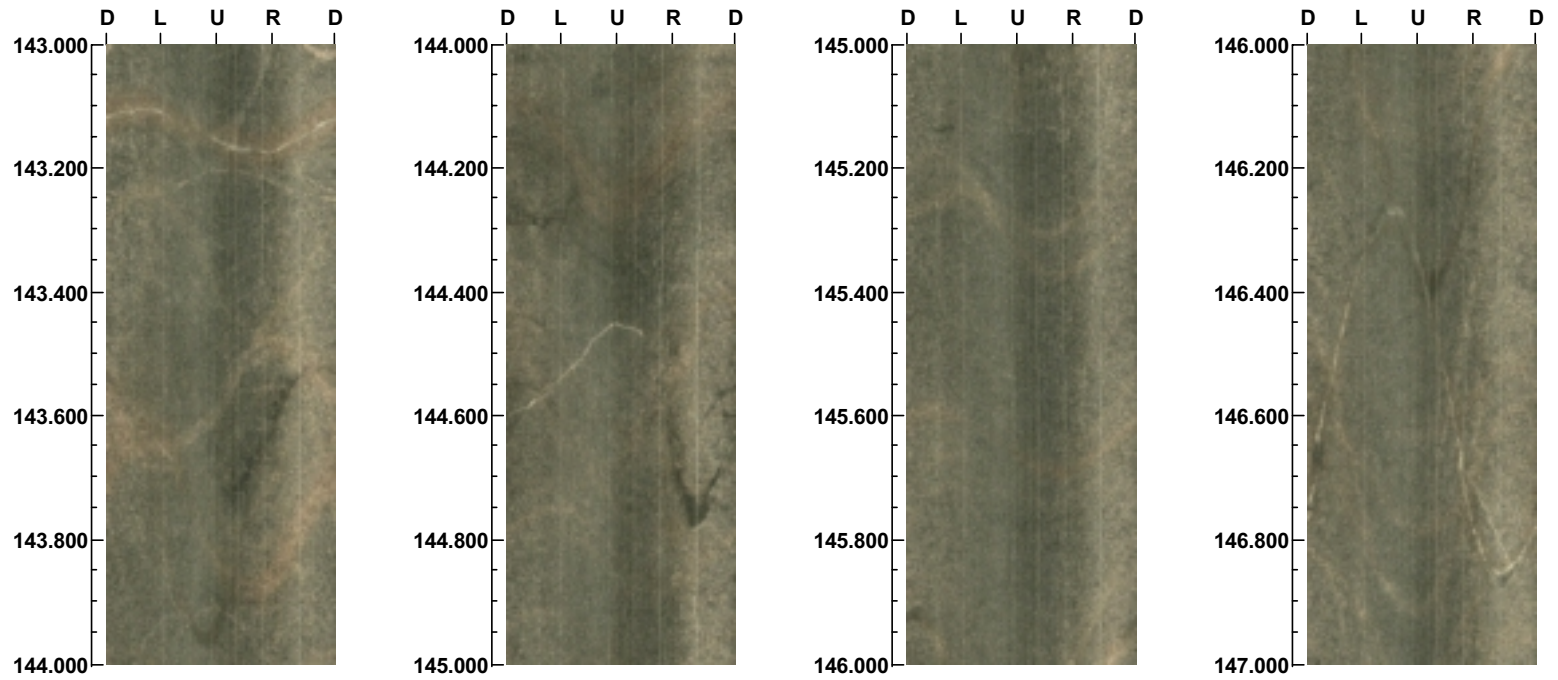

Project name: HSH03  
Bore hole No.: HSH03

Azimuth: 0      Inclination: -90

Depth range: 147.000 - 151.000 m

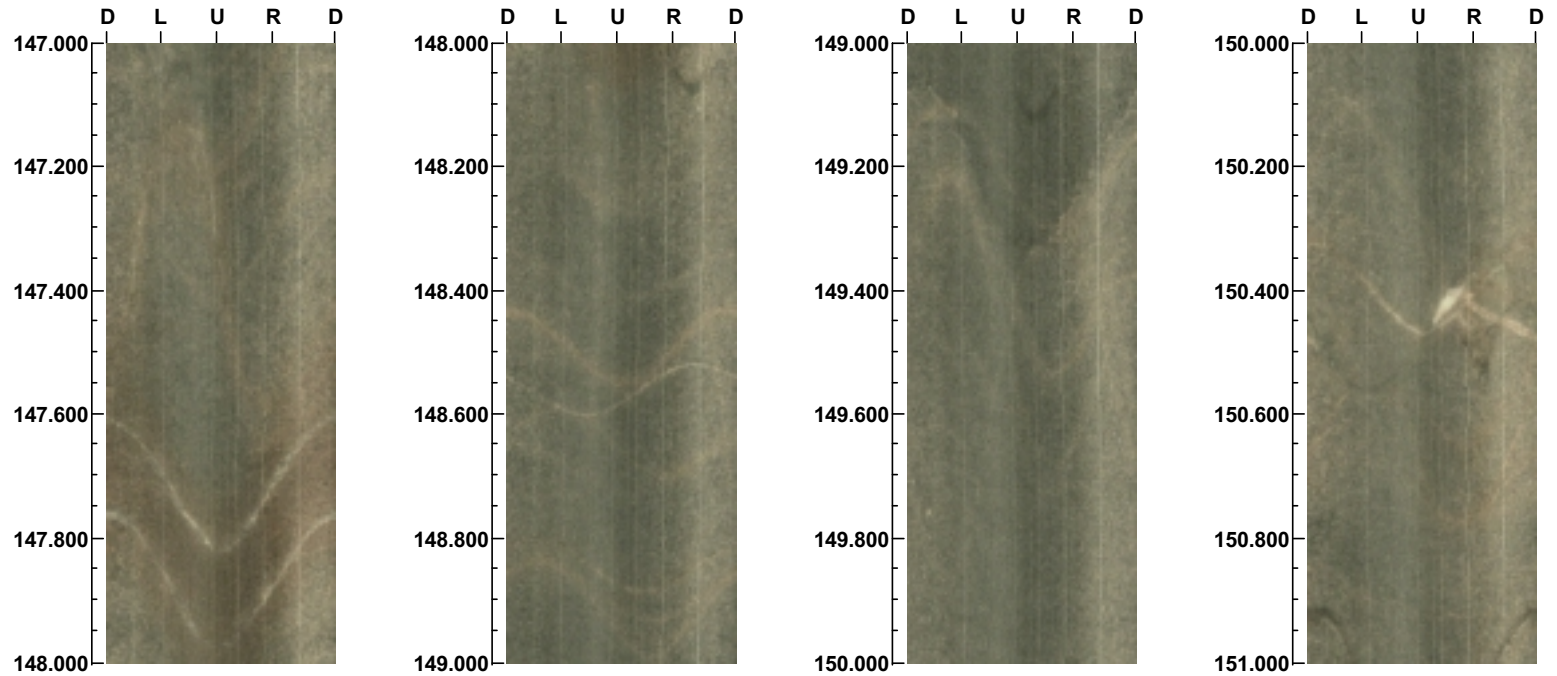

Project name: HSH03  
Bore hole No.: HSH03

Azimuth: 0      Inclination: -90

Depth range: 151.000 - 155.000 m

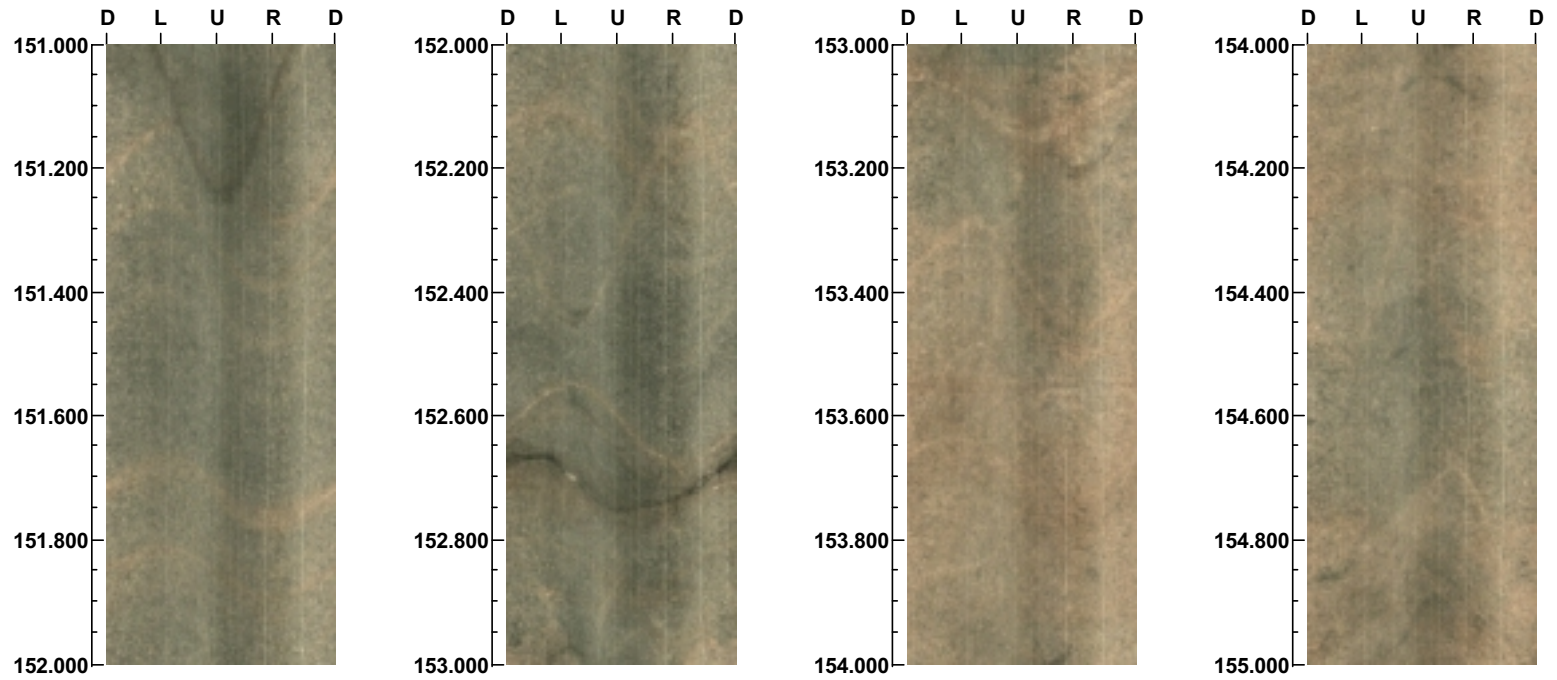

209



Project name: HSH03  
Bore hole No.: HSH03

Azimuth: 0      Inclination: -90

Depth range: 155.000 - 159.000 m

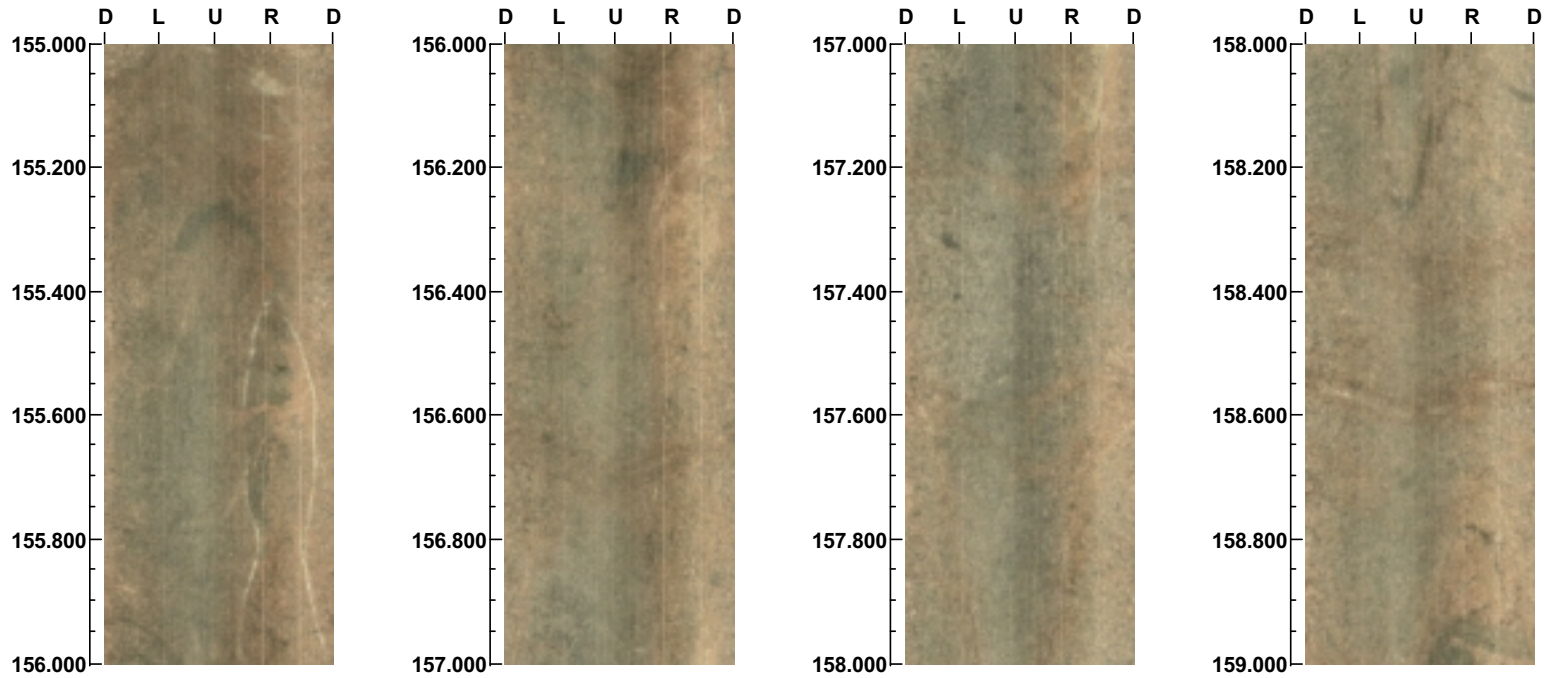

Project name: HSH03  
Bore hole No.: HSH03

Azimuth: 0      Inclination: -90

Depth range: 159.000 - 163.000 m

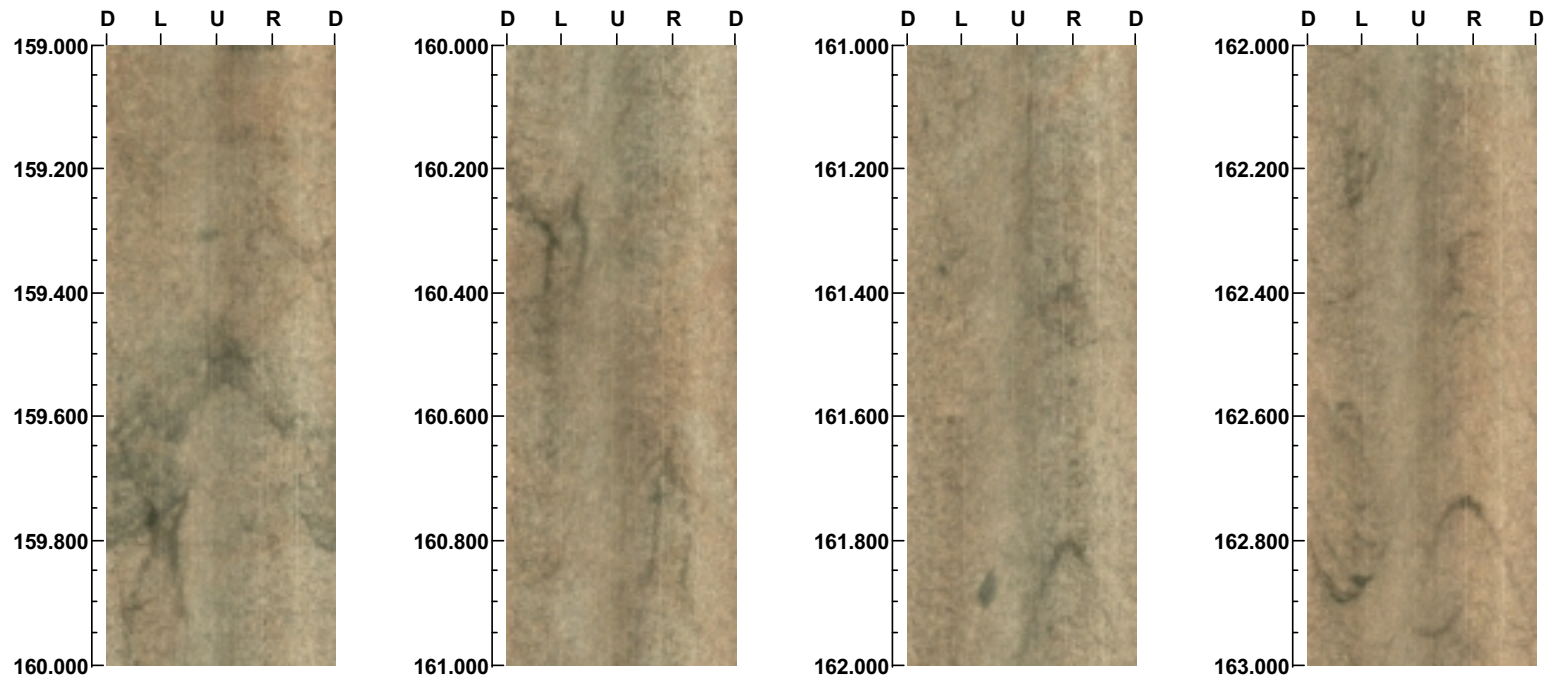

Project name: HSH03  
Bore hole No.: HSH03

Azimuth: 0      Inclination: -90

Depth range: 163.000 - 167.000 m

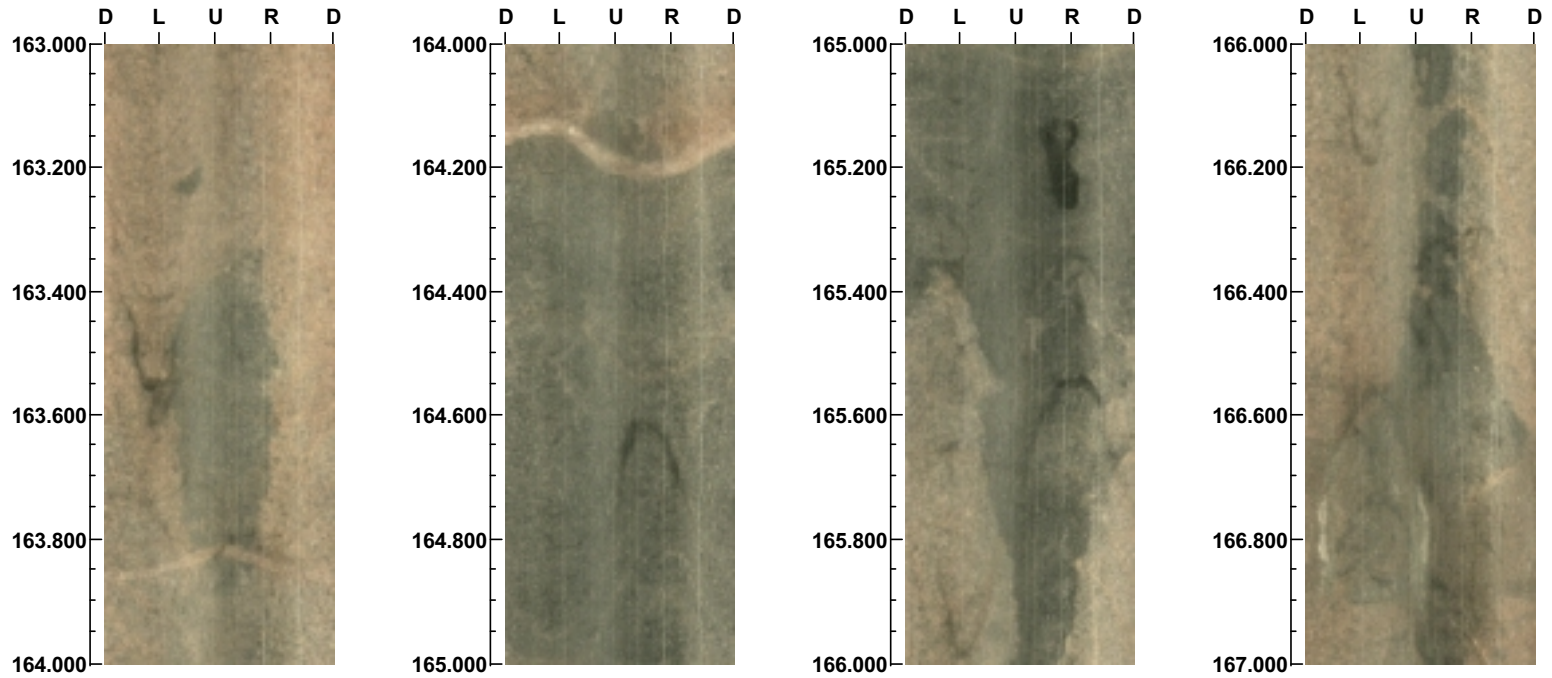

Project name: HSH03  
Bore hole No.: HSH03

Azimuth: 0      Inclination: -90

Depth range: 167.000 - 171.000 m

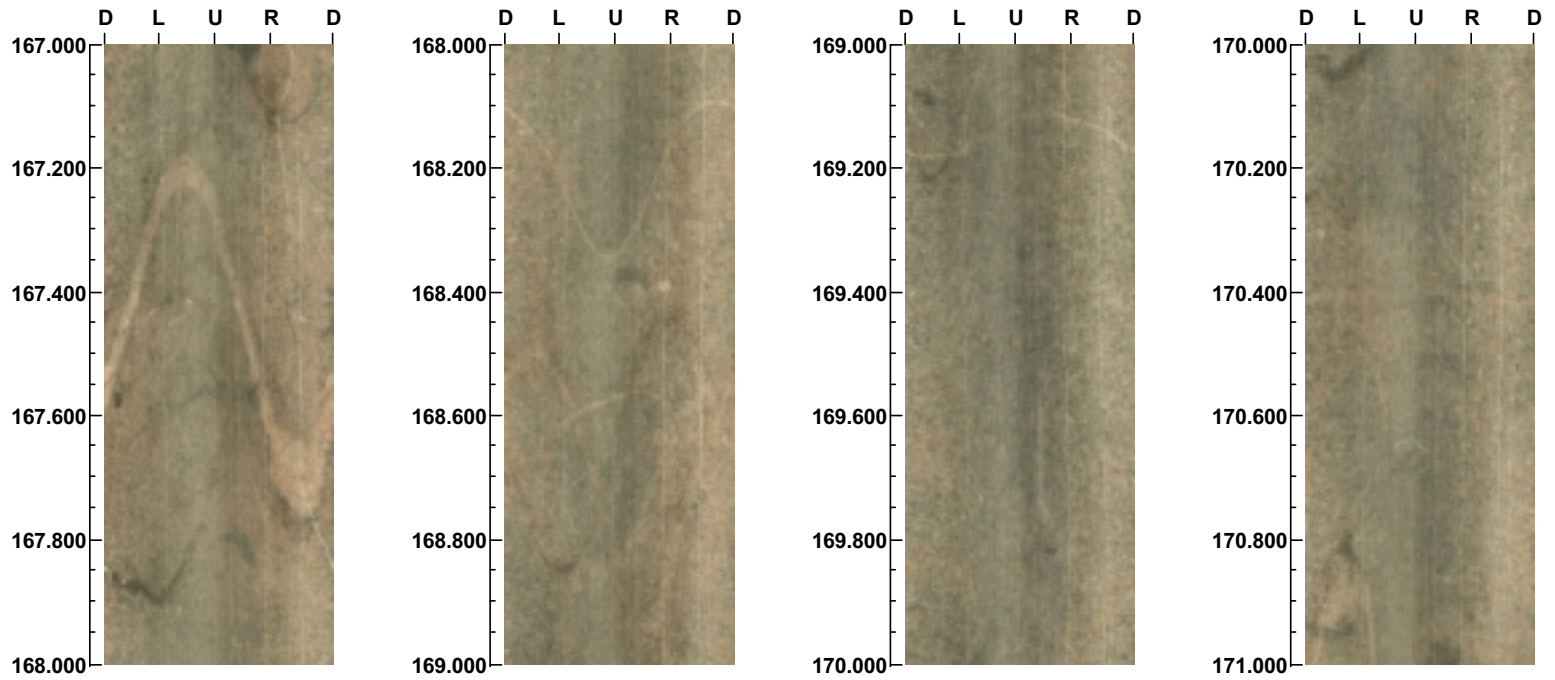

Project name: HSH03  
Bore hole No.: HSH03

Azimuth: 0      Inclination: -90

Depth range: 171.000 - 175.000 m

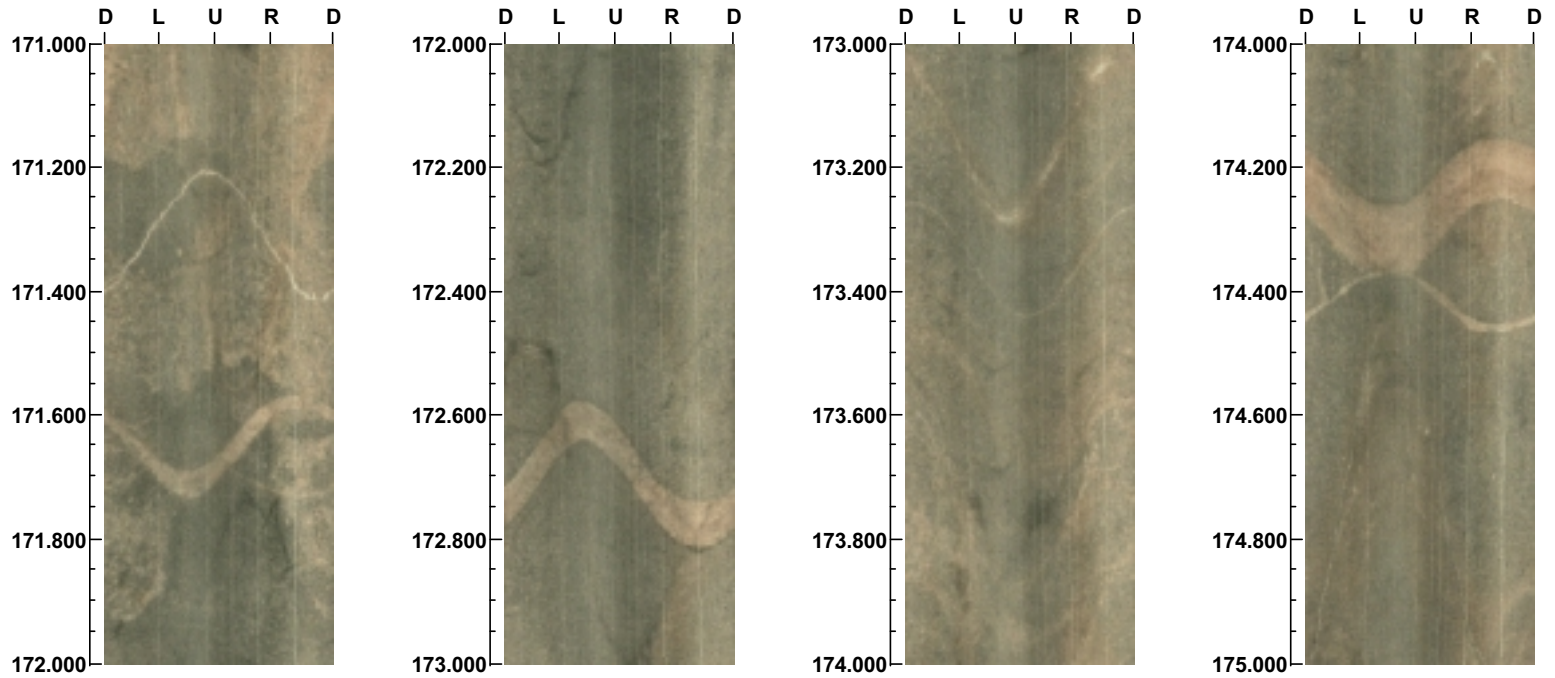

Project name: HSH03  
Bore hole No.: HSH03

Azimuth: 0      Inclination: -90

Depth range: 175.000 - 179.000 m

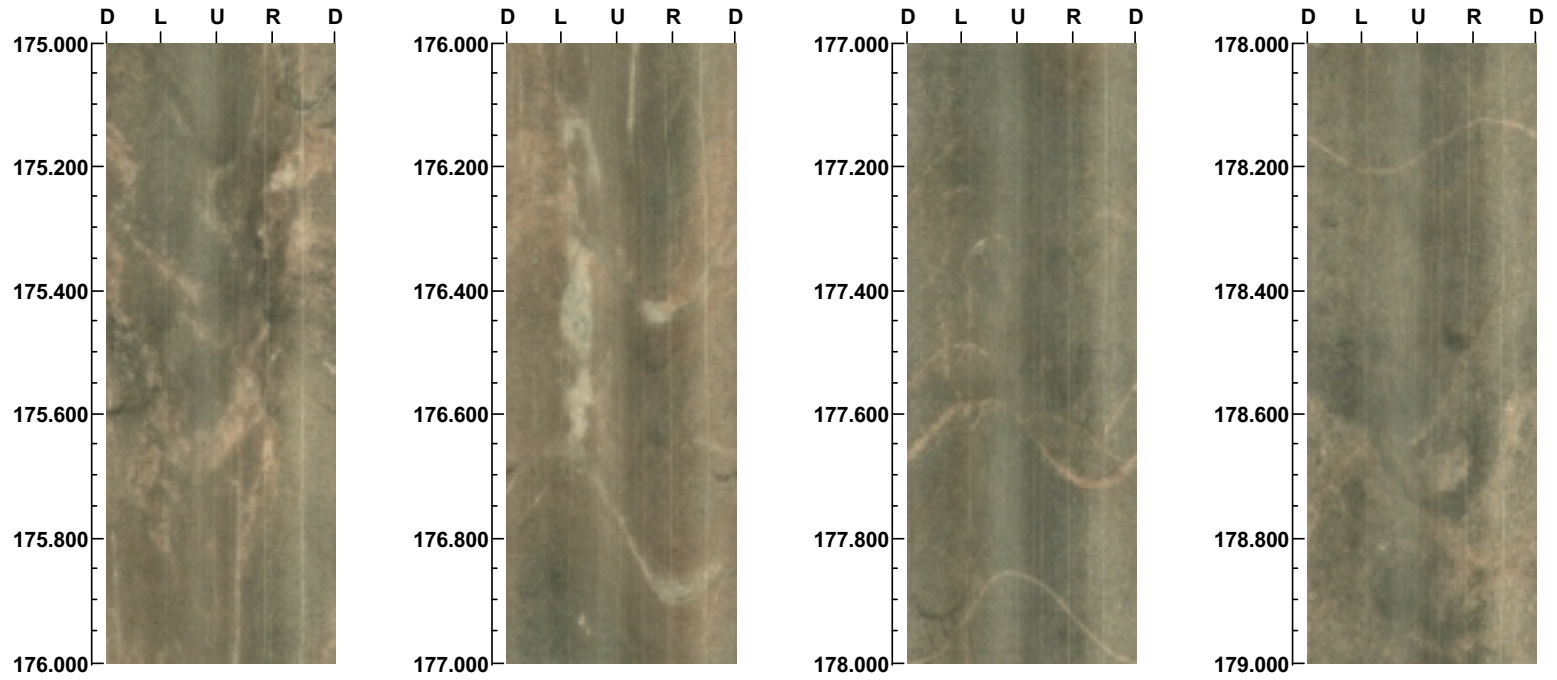



Project name: HSH03  
Bore hole No.: HSH03

Azimuth: 0      Inclination: -90

Depth range: 179.000 - 183.000 m

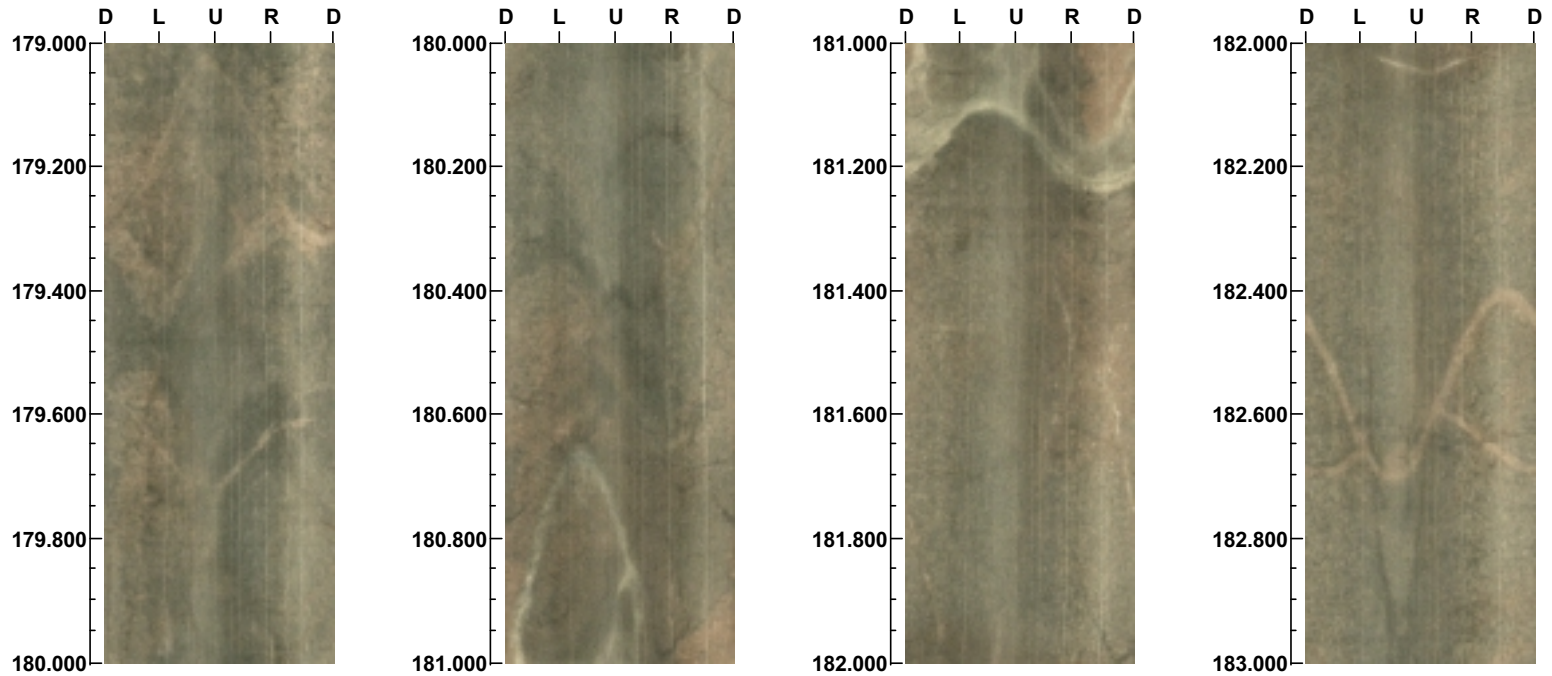

Project name: HSH03  
Bore hole No.: HSH03

Azimuth: 0      Inclination: -90

Depth range: 183.000 - 187.000 m

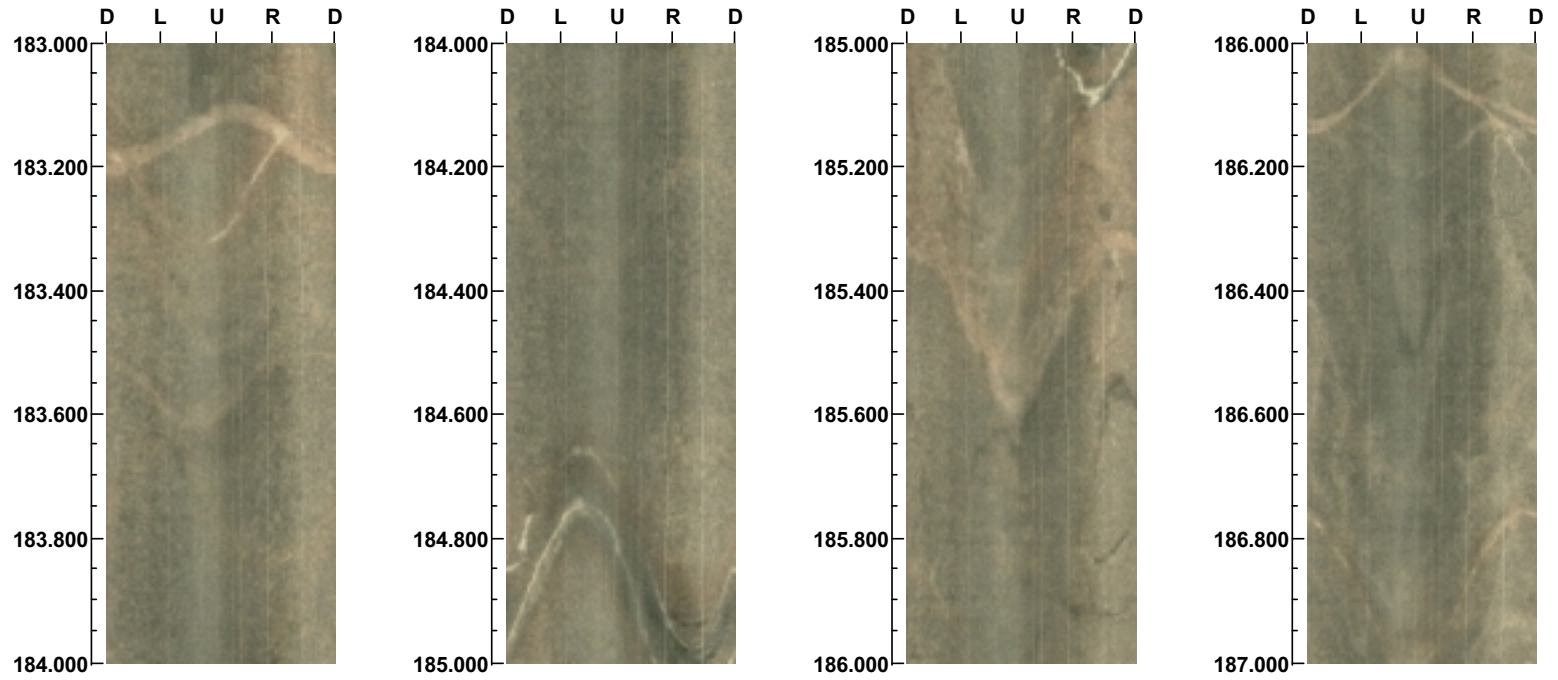

Project name: HSH03  
Bore hole No.: HSH03

Azimuth: 0      Inclination: -90

Depth range: 187.000 - 191.000 m

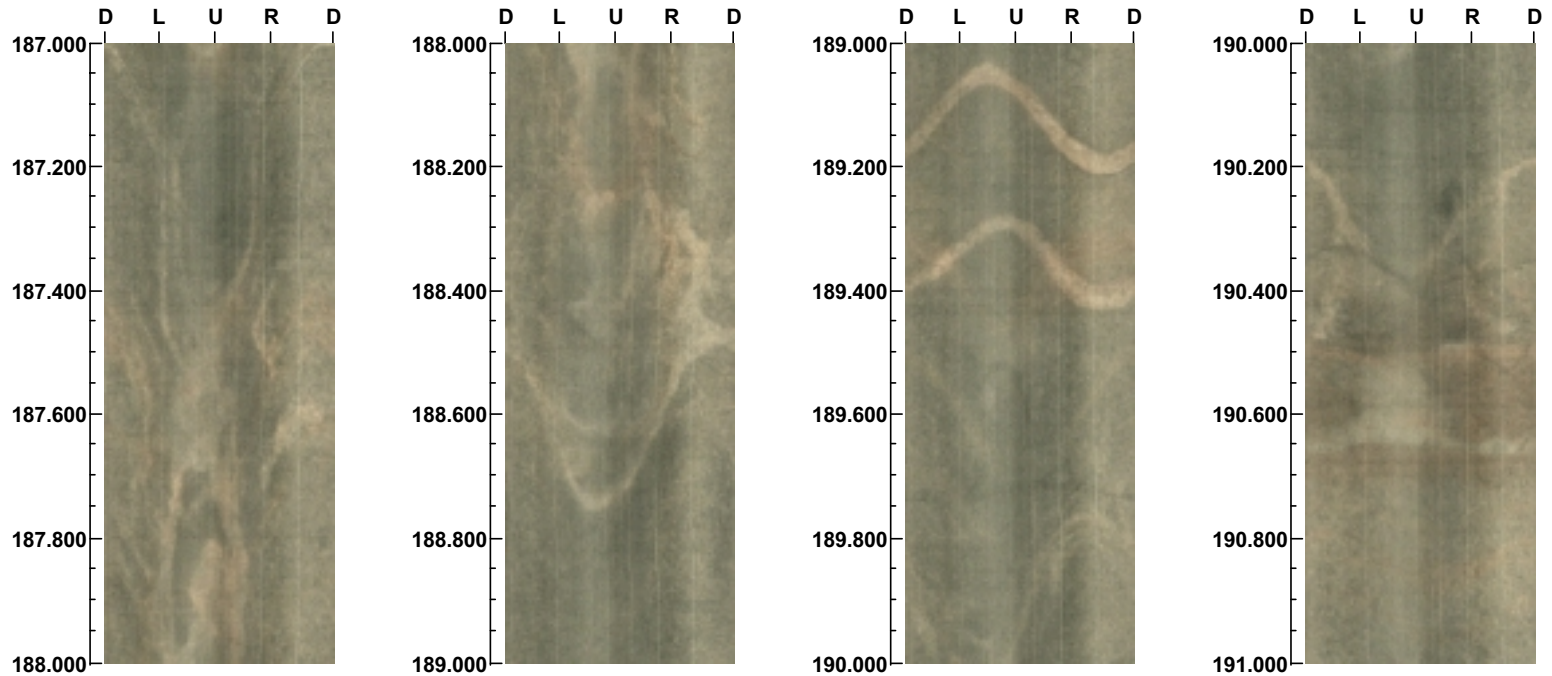

Project name: HSH03  
Bore hole No.: HSH03

Azimuth: 0      Inclination: -90

Depth range: 191.000 - 195.000 m

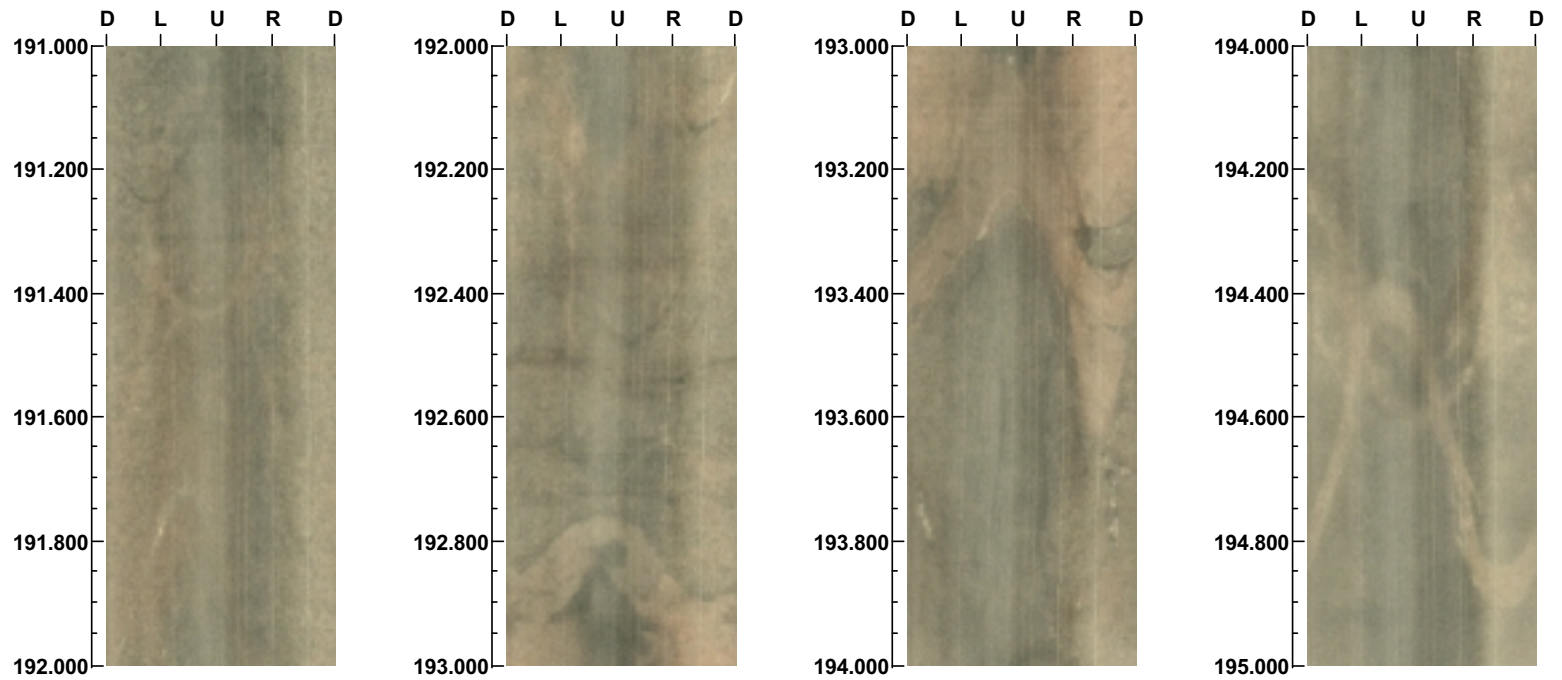

Project name: HSH03  
Bore hole No.: HSH03

Azimuth: 0      Inclination: -90

Depth range: 195.000 - 195.575 m

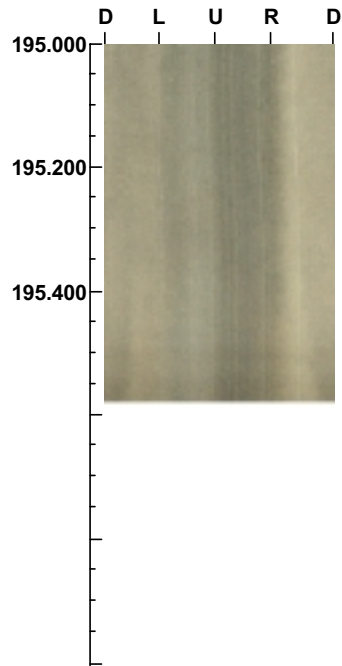

220

( 47 / 47 )

Scale: 1/10      Aspect ratio: 89 %