

R-02-45

Observation systems with alarm thresholds and their use in designing underground facilities

Lars Olsson
Geostatistik AB

Håkan Stille
Royal Institute of Technology

August 2002

Svensk Kärnbränslehantering AB

Swedish Nuclear Fuel
and Waste Management Co
Box 5864
SE-102 40 Stockholm Sweden
Tel 08-459 84 00
+46 8 459 84 00
Fax 08-661 57 19
+46 8 661 57 19



ISSN 1402-3091
SKB Rapport R-02-45

Observation systems with alarm thresholds and their use in designing underground facilities

Lars Olsson
Geostatistik AB

Håkan Stille
Royal Institute of Technology

August 2002

Contents

1	Introduction	5
1.1	Background	5
1.2	Definition of alarm threshold	5
1.3	Relationship to “active design”	7
2	Basic decision analysis in choosing system with alarm thresholds	9
2.1	General about decision analysis	9
2.2	Uncertainties	11
2.3	Relationship between indicator (model) and damage measure	12
3	Basic procedure for designing an observation system with alarm thresholds	15
3.1	General procedure	15
3.2	Finding the sensitive functions that are to be protected	15
3.3	Identifying the damage mechanism and the critical limits for the sensitive functions and finding suitable direct countermeasures	17
3.4	Finding observable/measurable indicators related to the damage mechanism and critical limits for those indicators	18
3.5	Identifying the construction work steps that can disturb the functions. Determining work procedure-related countermeasures	19
3.6	Predicting the behaviour of the rock, including the expected type of behaviour for these construction steps	20
3.7	Determining alarm thresholds considering countermeasures and the lead time	25
3.8	Detailed design of the observation system	26
3.9	Observation, follow-up and updating	30
4	Conclusions and further work	31
	References	33
	Appendix 1	
	Alarm thresholds – a tool for designing underground facilities	35
	Appendix 2	
	Some differences between the principles recommended in the report and the observation system used for CLAB stage 2	47

1 Introduction

1.1 Background

Observation systems with preset alarm thresholds have been increasingly used in underground construction work. One reason for this is that underground building projects are getting more and more complex at the same time as which automatic measurement systems with computerised data logging, processing and display have been developed.

The growing complexity and size of underground projects requires that precautions be taken to protect not only the building process itself but also the project environment, which may in turn contain sensitive processes. When deciding on what precautions are necessary it is important to note that there is a very large degree of uncertainty in underground projects. One approach that is often advocated is the use of observation systems with preset alarm thresholds, which initiate countermeasures if transgressed.

There have, however, been some problems with improper use of alarm thresholds, resulting in false alarms, and also with late or failed alarms, which can lead to very serious situations.

The cause of such problems may be the choice of too conservative levels, leading to a “cry wolf” effect, or a misunderstanding of the physical mechanisms so that the measurements do not reflect the real problem, leading to false confidence.

The use of monitoring systems and alarm thresholds therefore requires a careful analysis of the problem at hand. This should preferably be done using a systems analysis approach with risk and decision analysis.

After the successful completion of CLAB stage 2, the owner, SKB, requested a review of how to design a monitoring system, since some problems were encountered with the system used during the construction work. This report is therefore divided into a general part with recommendations on how to design a monitoring system and a specific part presented in two appendices dealing with certain aspects of the monitoring system used at CLAB stage 2.

1.2 Definition of alarm threshold

An observation system with alarm thresholds can be regarded as a protective system. As a working definition of “alarm threshold” we therefore propose the following:

“The alarm threshold is a predetermined value of one or a combination of several monitored parameters which, if exceeded, will trigger pre-determined measures in order to prevent damage.”

It is important that the alarm threshold really indicates that danger is imminent and that countermeasures are urgently needed. Otherwise the “cry wolf” effect will water down the perception of danger.

Examples of alarm thresholds:

- a) “The movement measured by extensometer No 1 exceeds 2.0 mm.”
- b) “The movement measured in the convergence measurement section C exceeds 6 mm and the rate is increasing (i.e. the time derivative is larger than 0) **or** the movement exceeds 10 mm.”

These examples of alarm thresholds are illustrated in Figure 1.

The alarm threshold does thus not have to be a single measured value, but it must be associated with something that can be observed and it must be unambiguously defined. It constitutes a boundary (dichotomy) between what we consider safe and what we consider dangerous, and we use it as a criterion for initiating countermeasures.

It is not even necessary that the alarm threshold can be expressed in numbers. A threshold limit might be formulated like this: “The rock mass is heavily jointed and the water inflow is great and increases with each blasting round”. Such an alarm threshold would obviously be used to indicate the need to switch to a more careful excavation method.

A very clear distinction must be made between the alarm threshold and the critical limit, the target value and the expected value. The critical limit is the limit where damage is expected to occur with an unacceptable probability. The target value, which is a guide to efficient and safe work, might for instance be a value of vibration during blasting and is set so that blasting can be carried out with as large rounds as possible, but at the same time with a sufficiently low probability of exceeding the alarm threshold, see Figure 2. The chosen alarm threshold may in turn govern the choice of the target value, i.e. the value that is optimal from an economic and safety point of view. This is the value that will permit an efficient work strategy while taking into account the costs and inconvenience connected with exceeding the alarm threshold. The expected value, finally, is the value most likely to occur for a given design and construction process.

The observation system is not complete without pre-determined countermeasures to be adopted if the alarm threshold is exceeded. These measures should be designed to cope with the identified dangers, but it is sometimes also necessary to include a more general set of measures for those cases where the exact damage mechanism is not established.

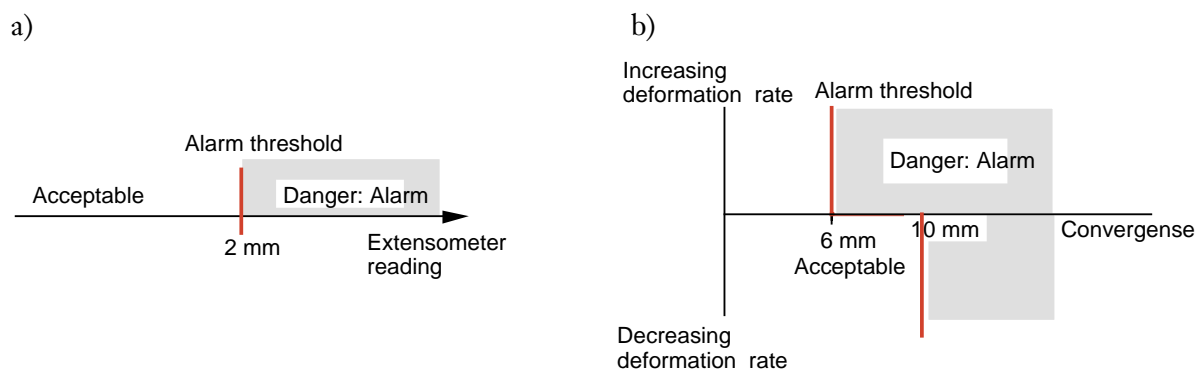

Figure 1. The example alarm thresholds given in the text.

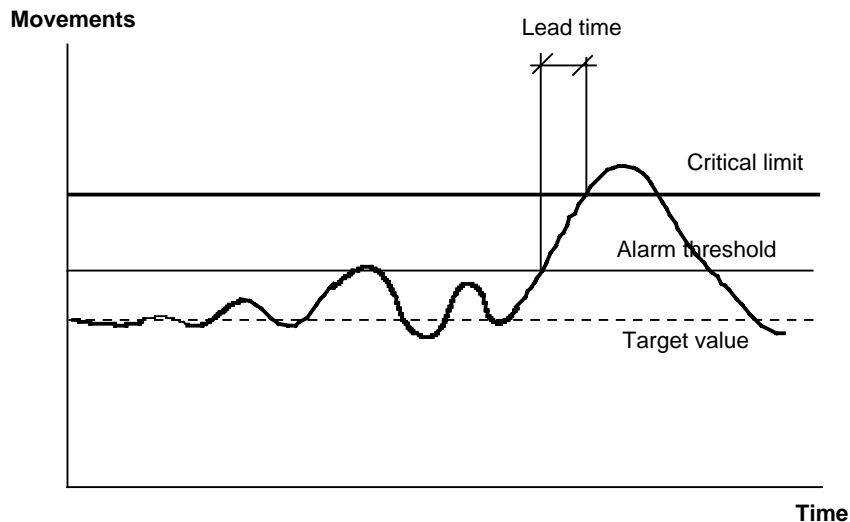

Figure 2. Alarm threshold and lead time. /After Paté-Cornell and Benito-Claudio, 1987/

The countermeasures take time to implement and to take effect. It is thus necessary to have some lead time between when the alarm is given and when the movements etc reach a critical value, see Figure 2. This lead time depends on the type of countermeasures to be taken, equipment availability, and not least the organisation. This means that not only purely technical factors must be considered when determining the alarm threshold, but also human error etc.

In the figure, the lead time is insufficient, so the movements will reach the critical value before the countermeasures take effect.

The choice of the alarm threshold thus depends on the following two quantities:

- The critical limit, which defines the point where damage will occur.
- The lead time, which is the time necessary for countermeasures to take effect (and prevent the critical limit from being exceeded).

An understanding of the principles behind the alarm threshold is absolutely necessary. An example of incorrect setting of the alarm threshold is when some sort of expected value of calculated deformations is used as the alarm threshold, or when the alarm threshold is calculated deterministically using expected values of the parameters. This lack of understanding of the nature of the alarm threshold can lead to a situation where the alarm is triggered unnecessarily, leading to costs, frustration and mistrust.

1.3 Relationship to “active design”

Apart from being used as a protective system, the monitoring system can be used in design. Often in underground construction the “active design” or the “observational method” /see e.g. Peck, 1969/ approach is applied.

This method is based on a previous analysis of the problem and determination (in advance) of modifications to be made in the building procedures, based on observations made, /Bredenberg et al, 1981/. (The same principle as in “active design” is provided for in the forthcoming Eurocode as the “observational approach”).

It must be observed that the use of these methods requires a reliable system for information management, as all concerned actors must be kept updated.

A point to remember is that in the Eurocode these methods are explicitly mentioned as a permissible approach, see the extract below:

2.7 Observational method

(1) POS When Prediction of geotechnical behaviour is difficult, it *can* be appropriate to apply the approach known as “the observational method”, in which the design is reviewed during construction.

(2)P REQ The following requirements shall be met before construction is started:

- the limits of behaviour which are acceptable shall be established,
- the range of possible behaviour shall be assessed and it shall be shown that there is an acceptable probability that the actual behaviour will be within the acceptable limits,
- a plan of monitoring shall be devised which will reveal whether the actual behaviour lies within the acceptable limits. The monitoring shall make this clear at a sufficiently early stage; and with sufficiently short intervals to allow contingency actions to be undertaken successfully,
- the response time of the instruments and the procedures for analysing the results shall be sufficiently rapid in relation to the possible evolution of the system,
- a plan of contingency actions shall be devised which may be adopted if the monitoring reveals behaviour outside acceptable limits.

(3)P REQ During construction, the monitoring shall be carried out as planned.

(4)P REQ The results of the monitoring shall be assessed at appropriate stages and the planned contingency actions shall be put in operation if the limits of behaviour are exceeded.

(5)P REQ Monitoring equipment shall either be replaced or extended if it fails to supply reliable data of appropriate type or in sufficient quantity.

In this type of application of the observational method, predetermined actions are taken when certain limits are reached. These limits would be lower than the alarm thresholds, as the idea is to optimize the construction work, not just to avert danger. These types of thresholds may be called “design thresholds” since they are related to changes in the design and have nothing to do with averting danger.

One can therefore view the use of alarm thresholds as a special case of the “active design” approach, where the predetermined action is to stop the work and give the alarm, whereupon the predetermined countermeasures are adopted.

2 Basic decision analysis in choosing system with alarm thresholds

2.1 General about decision analysis

The choice of an observation system with alarm thresholds is part of the bigger decision problem of choosing the best design and excavation method. As it is a decision problem, conventional decision methodologies can be used to illustrate and structure the problem.

In Figure 3 the problem is illustrated in the form of a decision tree.

In the figure, in which the possible path of events unfolds from left to right, the possible events along each path are written above the path and the probability that the chain of events will follow that path is stated underneath. (The sign # denotes the complementary probability, i.e. 1-(probability of the other branch).

At the end of each path is the (economic) consequence. These consequences must be projected with care. For instance, in the figure, should the outcome “False alarm” include full execution of countermeasures? (It will probably be discovered that the alarm is false after the countermeasures are started.)

Thus, each path in the tree can be followed to find both the possible outcome and also calculate the probability of that outcome. This information can be used in deciding which monitoring system to choose, see e.g. /Olsson and Stille, 1980/.

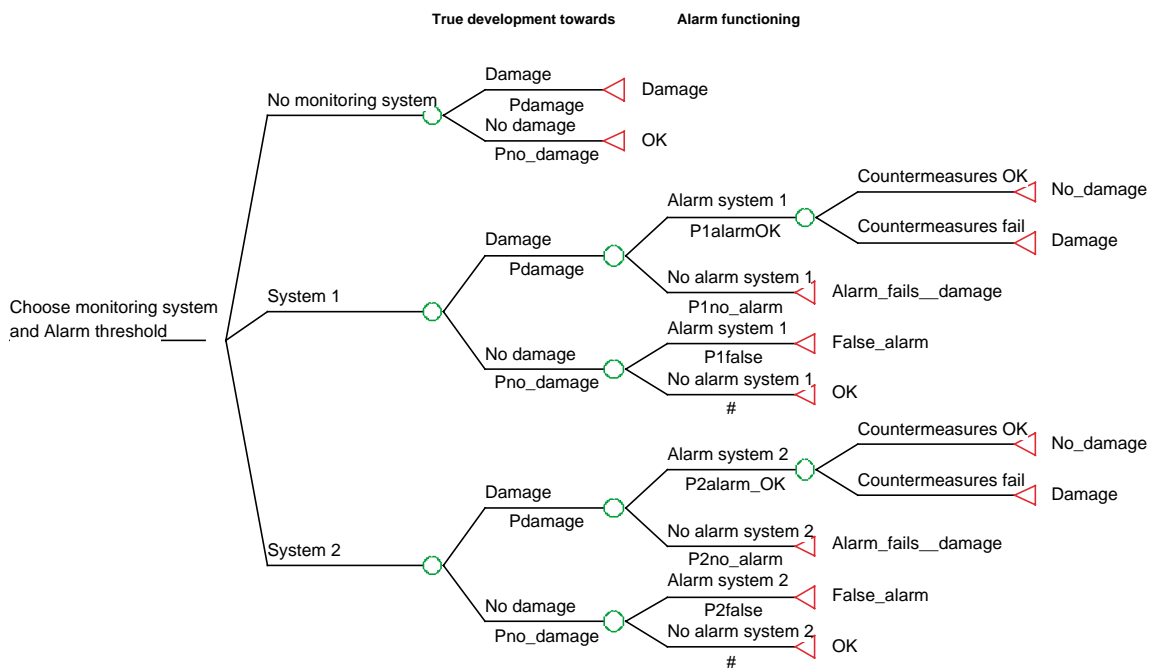

Figure 3. Decision tree for choice of alarm threshold.

One criterion for choosing is the lowest expected cost, which is the weighted sum of all the cost consequences that are possible when that system is chosen. The weights used are the probabilities of those consequences occurring.

While this criterion is widely used, it is not always useful for underground projects. This topic will be touched upon later on.

As can be seen from Figure 3, there are several factors that affect the choice.

These are:

- The consequences of each branch.
- The cost of each monitoring system.
- The probability of each branch, including the overall probability of damage with the design chosen.

This leads to the following observations:

- the effectiveness of the observation system and the chosen alarm thresholds are described as probabilities (of giving a correct alarm or a positive or negative false alarm),
- if the consequences are small, an expensive monitoring system is not justified,
- if the chosen design is safe, i.e. has a small probability of damage, (P_{damage} in the figure), a monitoring system might not be justified,
- if the probabilities are very small, even a very large consequence will have a small expected cost. Purely economically, this will not justify the cost of a monitoring system.

This last observation touches on the problem of very small probabilities and very large consequences (the “zero – infinity” problem). The usual expected cost criterion is not suitable for this case, and other methods should be used, see e.g. /Haimes, 1998/. This is an illustration of the hazards connected with using the product of probability and consequences as a sole decision criterion. Although the definition Risk = Probability x Consequences is widely used, the authors strongly advocate that this product never be called “Risk”, but “Expected cost” and that when talking about “Risk” the two components should always be shown separately, e.g. in a risk matrix.

In some cases, the safety principle must be: “It is simply not allowed to happen!” Obviously, the expected cost criterion cannot be applied in those cases. Monitoring is more or less mandatory, but no system is completely reliable, which leaves us with the question of the allowable probability that there will still be a failure. This is a very sensitive question and must be handled with great care. However, the decision analysis methodology for choosing an observation system and determining alarm thresholds can still be applied if the probabilities and consequences can be determined.

An interesting use of the methodology is to determine the “value of perfect information” /see e.g. Olsson and Stille, 1980/, which permits the maximum value of a perfect alarm system to be determined. This makes it possible to decide at an early stage whether to continue working on the design of the alarm system or to abandon the effort on the grounds that the expected value of even a perfect system is so small that the cost cannot be justified. If this is the case, a more robust design or construction method might be called for.

The decision analysis approach is very clear-cut and powerful and gives a good overall picture of the problem, but it requires that both consequences and probabilities be determined.

2.2 Uncertainties

The probability of damage is strongly correlated with the uncertainties involved. There are several different types of uncertainties such as rock mass data uncertainty, model uncertainty and measurement uncertainty.

The amount of data that forms the basis for decisions is usually very limited, giving rise to uncertainty both in the mean values of the properties but even more in their correlation (standard deviation, autocorrelation). This problem cannot be solved by trying to obtain more samples, as the number of sampling points will be unrealistic. Instead, engineering experience should be incorporated through the use of Bayesian statistics.

Another source of rock mass data uncertainty comes from the misapplication of classification methods such as the rock mass index. A classification process can lead to loss of information and thus increased uncertainty.

As has been pointed out above, the calculation model itself is not necessarily correct, but includes uncertainties. These may stem from deliberate simplifications, both in the description of the problem, e.g. its geometry, and in the choice of which type of model should be applied, e.g. a continuum model versus a discrete one. They may of course also stem from a lack of knowledge, on the part of either the individual or the entire profession.

Measurement uncertainties are also important to consider. All too often building site measurements are supposed to be exact, which they definitely are not. One should always be aware of the uncertainty of the measurements and include it by describing the measurement result as a stochastic variable in a manner analogous to Figure 5 and also Figure 6, as bias may be present. The measurement uncertainty is partly statistical, and partly the result of measurement technique, including both the instruments and their application.

The statistical uncertainty can be reduced by repeated measurements, as it is a sampling problem and as such can be handled using statistical sampling theory.

The instrument and application uncertainties are more difficult to reduce as they may not be as obvious. Using recognized instrumentation and techniques should reduce these uncertainties, but a quality assurance system is a necessity.

One must acknowledge that there are limits to the resolution of the measurements, which is caused by measurement noise.

2.3 Relationship between indicator (model) and damage measure

There is a special type of uncertainty related to observation systems with alarm thresholds linked to the relationship between the indicators and the actual damage.

In the ideal case there is a deterministic, exact relationship between the observed indicator and the damage measure (degree of damage), see Figure 4.

As we can never be absolutely sure of the rock behaviour we must express the relationship between a damage measure (say dangerous settlements) and the observed indicator (say convergence) as a stochastic relationship, see Figure 5.

From Figure 5 it can be seen that for every observation x there is not a corresponding deterministic value of the damage measure y , but instead a conditional probability density function. This uncertainty can be large or small, depending on the precision of the model that transforms observations to damage measures. There may also be a bias, which gives a systematic error, see Figure 6.

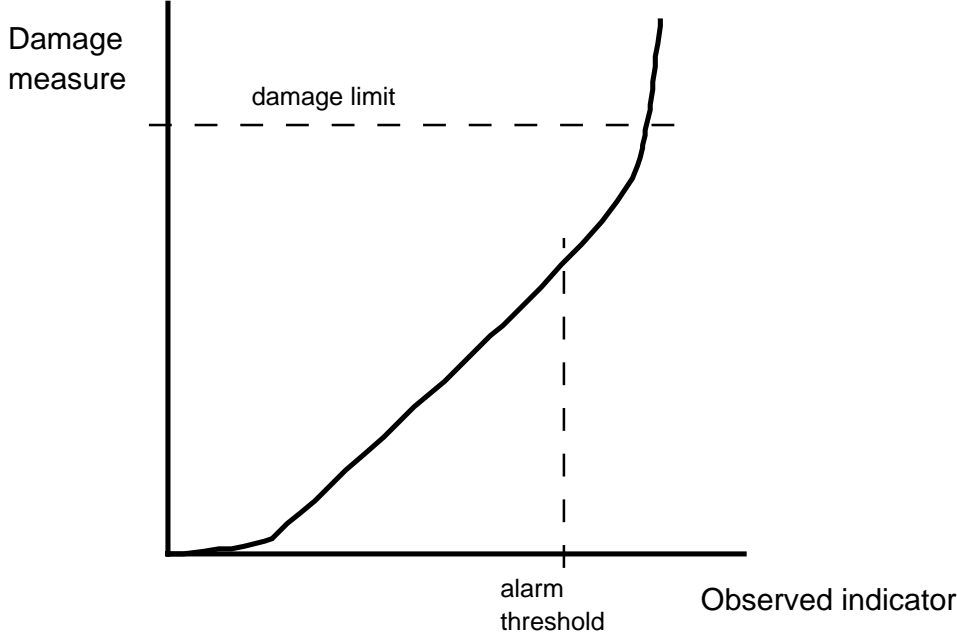

Figure 4. Ideal relationship between the observed indicator and the damage measure.

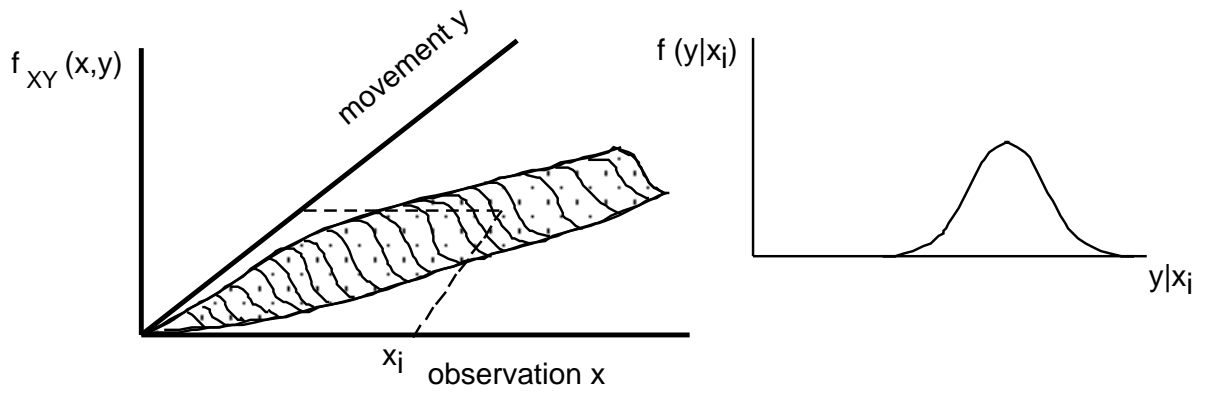

Figure 5. Stochastic relationship between observation and damage measure.

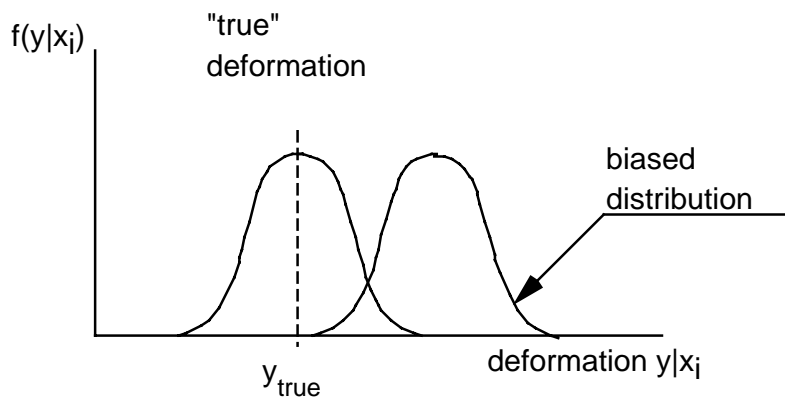

Figure 6. Bias in model.

3 Basic procedure for designing an observation system with alarm thresholds

3.1 General procedure

A systematic procedure should be used in designing the observation system with alarm thresholds and the basic requirements should always be met. This procedure depends on the “degrees of freedom” of the building project. (Can the location be changed to one with fewer problems? Is the design final? Are there other construction methods?) For the case where the design and location are final and the construction method has been decided on, a proposed procedure is presented below:

- Identify the sensitive functions that are to be protected.
- Identify the damage mechanism and the critical limits for those functions and find suitable direct countermeasures.
- Find observable/measurable indicators that are related to the damage mechanism and determine the critical limits expressed in those indicators.
- Identify the construction work steps that can disturb the functions. Determine work procedure-related countermeasures.
- Predict the behaviour of the rock, including the expected type of behaviour for these construction steps.
- Determine alarm thresholds considering countermeasures and the necessary lead time.
- Make a detailed design of the observation system.
- Implement, observe, follow up and update. Make changes if necessary.

3.2 Finding the sensitive functions that are to be protected

The fundamental idea of the alarm thresholds is to stop work before it can cause damage to any essential “functions”. The word “function” must be interpreted in a very broad sense as something which is necessary or desirable and that may not be damaged to such an extent that it is disabled. It must also be recognised that a primary overall function such as “production” is usually dependent on several secondary functions, e.g. “machine tool operation”. This means that not only the primary function, but also all secondary functions must be identified. For this a comprehensive analysis is needed using tools such as system analysis and risk analysis (e.g. fault tree analyses).

Damage to functions can affect

- the surroundings,
- the building process.

Surroundings

Damage to the surroundings may be of a physical nature:

- damage to persons (traffic accidents with construction vehicles, flying rocks etc),
- property damage (cracks in buildings),
- damage to the environment (lowered ground water table, contamination, irreversible damage to biotopes),
- damage to work and equipment used by third party from vibrations, movements etc.

Furthermore, it may be of an “objective” physiological nature such as vibration, dust, noise etc or of a subjective nature (discomfort, fear etc). This can cause both disruption of third party production and more general annoyance, maybe leading to loss of goodwill or instigating protest actions.

Building process

The building process may be damaged by events that cause

- injury to persons at the site (workers, visitors),
- damage to equipment,
- damage to the rock, necessitating unforeseen extensive measures, e.g. extra reinforcement, massive pre-grouting,
- damage to the intended function of the structure being built (necessitating maintenance or restrictions in usage),
- damage of an economic nature (delays and thus extra costs).

Another type of damage is loss of goodwill. This can befall both the builder and the client, and even the profession as a whole. (A recent Swedish example is the tunnel project “Hallandsås”, where ground water leakage led to a lowered ground water table and also to the use of a harmful grouting agent. Among the consequences were a suspension of works, legal actions and a general distrust of the construction industry on the part of the public.)

It is necessary to address all possible damage to these “functions”, which means that the functions must be identified and that their vulnerability to different effects must be recognised.

In order to do this it is necessary to adopt a risk analysis approach that also includes a system analysis to ensure that nothing is overlooked and safety surveys of those threatened establishments that have been identified.

3.3 Identifying the damage mechanism and the critical limits for the sensitive functions and finding suitable direct countermeasures

Once the sensitive functions (primary and secondary) have been found, the damage mechanism and critical limits must be identified. This work must be based on sound engineering know-how, and risk analysis tools can be helpful. It is very important in this analysis to focus on the function itself and not on the future impact of the construction work, i.e. “What can damage this function?” instead of “How may our blasting operations disturb the surroundings?”

Identifying the damage mechanism is a more or less straightforward procedure based on engineering knowledge. It may, however, be rather difficult sometimes to find the critical limit, i.e. the limit above which unacceptable damage is expected to occur. One reason for this is that designers are not accustomed to considering the critical limit but instead a “safe limit” according to codes.

Another reason is that “unacceptable damage” is not a clear-cut limit between “undamaged” on the one hand and “completely useless” on the other. Instead there is a continuous scale and the “damage limit” must be set subjectively. (The same problem exists in limit state calculations, especially for the serviceability limit.) This means that the critical limit is often uncertain. It should be possible to express this uncertainty in statistical terms, for instance by assessing the probability function. This uncertain limit can be used in the decision analysis used to determine the alarm threshold. This, however, must be single-valued.

For the environment, the critical limit may be e.g. deformation (often settlement but also lateral movement) or vibration (often expressed as v_{\max}).

For the building process, the critical limit is not only related to which function is disturbed but also to contractual factors. Elements of the contract such as penalties/incentives and rules for payment will determine both who will bear the risk, the contractor or the client, and the risk-willingness of the parties. These factors in turn influence the decision process when determining the critical limits.

It is difficult to assess the critical limit for intangible values such as goodwill. Experience from similar projects can be of help, but the question is difficult to answer.

However, it may be possible to assign a value to damaged goodwill and thus be able to enter it into the decision process. This can be done by estimating the costs incurred by lost contracts etc or the costs of restoring the goodwill by lobbying, media etc.

It should be noted again that the critical limits are to be entered into a decision process in which different construction alternatives must be studied, changes made, the decision process repeated, etc. This decision loop is dependent on the parameter values, both in the form of probabilities and in the form of costs.

If these factors are likely to be important, a risk information effort at an early stage can help identify them.

The observation system is not complete without predetermined countermeasures to be adopted if the alarm threshold is exceeded. These can be of two different types: Direct, and work procedure-related.

Direct counter-measures are applied at the threatened object itself. Examples of this are vibration isolation of sensitive equipment, truing up of movements in tracks, machine beds, etc.

These countermeasures must be defined in advance and be included in the contract between the client and the contractor to avoid spurious claims. Work procedure-related countermeasures are discussed in section 3.5

3.4 Finding observable/measurable indicators related to the damage mechanism and critical limits for those indicators

The quantities that we observe, and that have to be a part of the output of our predictive modelling of future behaviour, we will call measurable (or at least observable) indicators. As has been stated earlier, such an indicator can consist of one or a combination of measurements. All these components must of course be observable, otherwise another indicator must be chosen.

The general problem of choosing suitable indicators has been discussed in the literature, see e.g. /Krauland, 1982/ and /Stille et al, 1981/. Limitations on the choice of suitable indicators may be determined by the poor accuracy of many sophisticated measurement systems, especially during long-term use due to the severe environmental conditions related to underground works. Redundant measurement systems are therefore needed in many cases. One such redundancy can be obtained by including visual inspection with specified alarm thresholds. Visual inspection can also be used on its own as an observation system.

After a suitable indicator or a set of indicators has been found, the points to observe must be determined. These should be relevant for the indicator (and thus for the sensitive functions to be protected) in the sense that they are located where such movements of sufficient magnitude will occur. For instance, if rock mass deformation is to be measured, the points should be located so they can distinguish between general deformations and the local movement of a single block.

The points should also be chosen so that they are efficient, i.e. that the observation results will not contribute substantially to increasing the uncertainties. Geostatistical methods can be used to find efficient observation points, see e.g. /Hachich and Vanmarcke, 1983/.

3.5 Identifying the construction work steps that can disturb the functions. Determining work procedure-related countermeasures

The next step in the process is to identify those construction work steps that can affect the sensitive functions to such a degree that the critical limits are approached. This calls for a technical analysis of the building process to see whether any work steps can cause effects of a type to which the sensitive functions are vulnerable.

Some of these steps are very difficult to find, for instance exactly which work steps cause loss of goodwill, as the reason may be unclear.

In most cases, the work steps to be considered are those that subject the sensitive function to vibration and deformation. In order to identify which step in a chain of steps will disturb the sensitive function, the affected region must be determined. Or in other words, how far from the tunnel face etc will effects occur that can disturb sensitive functions? This can be measured in distance as well as in time (or number of rounds).

The identification and evaluation of these steps is a rock mechanics and/or a rock dynamics problem where a prediction must be made about future threats to the sensitive functions. Related to this is the problem of finding work procedure-related countermeasures. These are of two kinds: those aimed at protecting some identified sensitive function and those aimed at protecting the construction process itself.

Regardless of their aim, these measures should be designed to prevent the dangers that have been identified. But it is sometimes also necessary to include a more general set of measures for those cases where the exact damage mechanism has not been established.

The suitable countermeasures must be evaluated based on engineering skill and a good knowledge of the problems to be solved. In some cases it may be preferable to use a more robust building method to reduce the complexity of suitable countermeasures.

The problem with unforeseen causes of disturbances cannot be handled in this way, of course. To protect against unacceptable disturbances of a sensitive function in the building process itself or in the surroundings, the construction process used must be "robust". This can be accomplished by using short rounds, extensive reinforcement, etc.

As with direct countermeasures, these countermeasures must be defined in advance and be a part of the contract between the client and the contractor to avoid spurious claims.

3.6 Predicting the behaviour of the rock, including the expected type of behaviour for these construction steps

In order to predict if we are approaching a critical limit for a function, we need to predict future disturbances of this function. This prediction must be effective in the sense that it can correctly tell us from measurements (or general observations) both if the rock mass is behaving as predicted (i.e. the prediction is “correct”) and if we are approaching a critical limit.

For this prediction, a prediction model is needed that has certain properties:

- It can handle the uncertainties that are inherent in the rock mass properties and in the execution of the construction work.

This means that it will have to be based on a system that allows for the description of uncertainties in all parts of the model and calculation of the overall uncertainty. This is usually a system based on probabilities, but other systems are possible, e.g. fuzzy logic.

- The output of the model must be in the form of observable quantities, otherwise it is not useful.

These quantities are not necessarily direct observations of the sensitive function itself but of an observable substitute. We might for instance be measuring convergence close to a tunnel face but, what we really want to protect is a foundation which is sensitive to settlements but which is not readily accessed. The model must thus be able to translate an observable quantity into the subject of our primary interest: the critical limits for the function that we want to protect. This adds to the total uncertainty, as such a translation is not usually absolutely certain.

- It should permit verification of the model through the observations.

It should be possible to verify the model by comparing prediction and observation. This verification should take into account the imprecision of the measurements.

The principal uncertainties, besides uncertainties in the rock mass data, are uncertainties in the relationship between the indicators and the damage, uncertainties in the calculation method, and measurement uncertainties.

From the above it can be seen that the following ingredients are needed to construct the model:

- a thorough knowledge of the overall problem based on an understanding of the sensitive processes and an understanding of the physical mechanisms involved,
- rock engineering skill,
- the rock mass parameters of the site including uncertainties,
- the relationship between the actual sensitive function and the observable indicator.

Different types of models can be used to predict rock behaviour and whether a dangerous condition is approaching.

The main model types are:

- Measurement-based models.
- Type-of-behaviour models.
- Type-of-behaviour plus rough deformation check models.
- Behaviour pattern models.
- Classification models.

Measurement-based models

These models are also called expectation models, because the expected deformation is compared to actual measurements.

The main difficulty with these models is that you need a suitable quantitative analysis method and the correct parameter values. Allowance must be made for uncertainty in the model and parameters. At present this is usually done by simply using a deterministic model and subjectively deciding whether discrepancies between predicted and observed values can be accepted or not (engineering judgement). When a deterministic model is used, there is really no alternative to this subjective approach because a strict deterministic analysis would say that all measurements must exactly coincide with the prediction, otherwise the prediction (hypothesis) is wrong.

The alternative is to estimate all uncertainties including those caused by the construction work and to include these in the calculations. This can be more or less difficult depending on the rock mechanical analysis method used.

If an analytical analysis is used, e.g. Monte Carlo simulation or FORM (first order reliability method), the calculations are easy to perform. The main problem is to determine both the uncertainty of the calculation model and the uncertainty in the data. The calculation model uncertainty can be estimated by comparing observed and calculated values and using this ratio as a stochastic correction factor. A Bayesian (subjective) approach can also be employed in order to supplement measured data with engineering experience.

It will often be observed in that the calculated values overestimate the observed ones. This is due to a “built-in safety factor” /Olsson, 1986/ used in calculations.

Estimating data and their reliability is a geostatistical problem and can be handled with e.g. kriging methods. The rock mass properties usually have some spatial correlation which must be considered, for instance when estimating uncertainties in averages over a volume, see e.g. /Vanmarcke, 1980/. Due to the scarcity of data, a Bayesian approach is almost mandatory.

To these uncertainties should be added the measurement uncertainty to give the total uncertainty of the prediction.

Most often the rock mechanical problem is such that a numerical modelling approach, such as Finite Elements, must be used. This calls for an extensive technical analysis, which is perhaps not appropriate in the early stages of a project, when the aim is to arrive at suitable construction methods, but instead in the later stages when the finishing touches are being made. Such models cannot normally include uncertainties in the data. However, the so-called Stochastic Finite Element method can be used, where solutions are found by means of Monte Carlo methods, perturbation methods or Taylor series expansion methods. In such methods, the uncertainty can be incorporated by specifying means and correlation structure. It has been pointed out by /Auvinet et al, 1996/ that Taylor expansion stochastic finite elements can be introduced as an supplement to existing FE programs without any modification of the latter.

Parameters can be found in the same way as for analytical models. It must be stressed however, that the autocorrelation in the rock mass must be included in the FE model /Baecher and Ingra, 1981/, which means that element size must be considered from this point of view.

Using either an analytical or a numerical method, the stochastic FE model will give not only the expected (mean) value of the deformation in a measuring point, but also its uncertainty, given as a standard deviation. The standard deviation has a great influence on the prediction capacity of the model.

Type-of-behaviour models

Often in hard rock mechanics, the rock is expected to behave in an elastic manner, and if it starts to behave in a plastic fashion, measures must be taken. This can be used as a behaviour prediction model by monitoring deformation and checking behaviour. A theoretical example is shown in Figure 7. In the example, the measured points at first seem to follow the straight line, but later the measurements can be interpreted as following a plastic deformation curve, which may indicate approaching failure.

With elastic behaviour, deformations are supposed to follow a straight line. Of course, real measurements will not follow a perfect line due to measurement errors etc, so a method is needed to determine the probability that the true movement follows an elastic model even if measurements suggest some doubt.

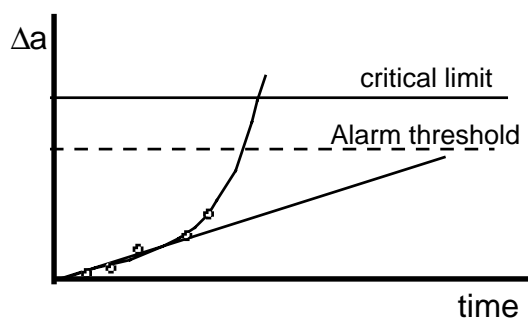

Figure 7. Theoretical example of measurements showing elastic – plastic behaviour.

Statistical methods for this purpose can be taken from statistical surveillance techniques, see for instance /Frisén, 1992/.

Type-of-behaviour plus rough deformation check models

This type of model is a special case of the type-of-behaviour model. It is used when it is important not only that the rock behaves elastically, but also that the deformations do not get so great that they cause damage, for instance to nearby structures or to installed reinforcement etc.

Behaviour pattern models

These models are used to check that rock movements do not continue when the load is constant (the excavation is finished) and that movements do not accelerate. They are not concerned with the magnitude of the movements, only the pattern of their behaviour. Statistical surveillance methods can be used to determine if there is a change in the pattern of the time series of measurements.

Classification models

The purpose of classification models is not to predict deformations etc but to classify the rock excavation procedure combination as “safe” or “unsafe”. This is done using one or more indicators that can be of different type, for instance rock quality indicators, deformation indicators (e.g. cracks in shotcrete), etc. The usefulness of the indicators in differentiating between “safe” and “unsafe” depends on how much data are available from previous projects. If enough data are available, statistical or similar methods can be used, see e.g. /Hand, 1997/.

Several suitable methods from different disciplines are available:

- Statistical methods that can be used include e.g. cluster analysis to find groupings in data and discrimination models to place a data vector in a prescribed class.
- Other methods based on data are AI (Artificial Intelligence) methods, for instance neural net models or genetic algorithms. These methods are powerful, especially when the relationships are non-linear, but at the same time they are a “black box” in the sense that it is not known how they achieve the goal.

These methods can be “trained” using known data sets. As such sets can be scarce, a possibility might be to create synthetic sets by giving a panel of experts rock mechanics data and asking them to make a judgment of whether the situation is stable or not.

- Other possible methods are (Bayesian) classification trees, which have a causal structure and have been used for instance in medicine. One possible way to assess data from experts is to apply Bayes’ theorem and to have the experts assess the conditional probability of a certain observable, e.g. “What is the probability of observing cracks in the shotcrete given that the rock cavern is unstable. In other words, what is $P(\text{crack} | \text{unstable cavern})$? Purely expert-based methods that are potentially useful are expert systems and ranking methods.

Expert systems have the advantage that they show the logic used to reach a result, but designing such systems is a daunting task. It has also been observed that it is difficult for the experts to formulate the rules that they use in making decisions. Among ranking methods, AHP (Analytic Hierarchy Process) seems well suited to this task. The principle of this method is to create a hierarchic structure describing the problem and then, by using a pair-wise comparison procedure, find the relative weights of different factors. Another use of AHP is in making a choice between different observation systems when a strict decision analysis method is not suitable or possible. A hypothetical and very simplified example is shown in Figure 8.

After evaluation using a pair-wise comparison, the experts' opinion is obtained regarding:

- How likely are the failure modes?
- Which indicator is most effective for each failure mode?
- Which indicator is most effective overall?

All results are expressed as numbers on a ratio scale, so that it can for example be said that for this (theoretical) case, observing water from drill holes is 2.3 times as effective as probe drilling.

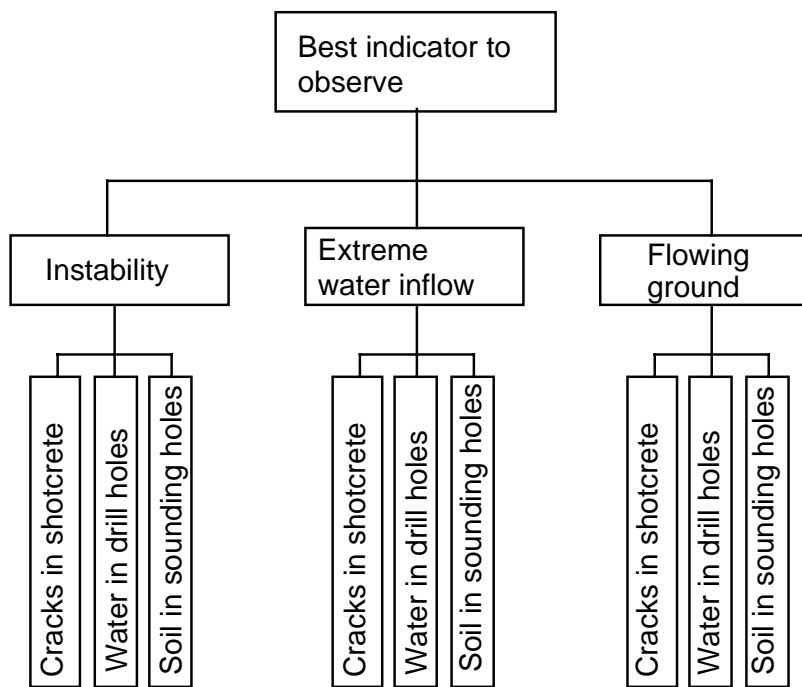

Figure 8. AHP analysis of a hypothetical simplified observation system.

3.7 Determining alarm thresholds considering countermeasures and the lead time

Basic considerations have been described above. The necessity of performing a risk analysis that includes organisational factors is stressed.

To repeat: determination of the alarm thresholds must be treated as a decision problem. It is influenced by several factors, see the section. “The basic decision analysis problem of choosing alarm thresholds”. Evaluation of these factors has been treated above.

As many parameters influence the design of the system and thus the choice of alarm thresholds, there is no fixed way of determining this design. A couple of observations should be made though:

- The alarm threshold is a deterministic (fixed) value. Although it is the result of a stochastic analysis, the alarm threshold must of course be dichotomous in nature. Either there is cause for alarm or there is not.
- The alarm threshold, although deterministic, is not necessarily fixed. This can be illustrated by Figure 7. If the rock mass behaviour changes from elastic to plastic (perhaps indicating imminent failure), the alarm threshold must be lowered considerably in order to create the necessary lead time.

The following factors influence the time needed to initiate countermeasures:

- Measurement interval.
- Precision and resolution of measurements.
- Time needed for performing measurements.
- Time for processing data.
- Time for decision to initiate countermeasures.
- Time for countermeasures to take effect.

The measurement interval and measurement precision determine the maximum time that can elapse between transgression of the alarm threshold and its detection.

The longer the interval, the greater the probability that the alarm threshold will be exceeded. This probability of course also depends on the velocity (time derivative) with which the measured indicator changes. Of course the necessary lead time is stochastic and the probability that it is sufficient is needed in the stringent decision analysis

The time needed to perform the measurements can vary widely depending on factors such as availability of special personnel, automatic or manual reading, need to install measurement points for each measurement, number and accessibility of measurement points, etc.

The time for processing data depends on factors such as availability of special personnel, automatic or manual data processing, number of measurements etc.

The time for decision to initiate countermeasures is an organisational question and depends on the time for information transfer, the availability of an appointed decision-maker, etc.

The time for countermeasures to take effect from the time of decision is governed by both organisational and technical factors. The organisational factors are time for information transfer, availability of personnel, training of personnel and readiness of necessary equipment. Technical factors are for example transport time, necessary working time, time for the measures to take effect, etc.

As can be seen from the above, the design of these countermeasures is basically a rock mechanics/underground construction problem, but their reliability (conditional probability of success) must also be assessed.

The countermeasures can fail not only for technical reasons, but also due to delays in their initiation. It is thus necessary to perform a risk analysis for the countermeasures as well. This analysis must take into consideration not only the technical side of the countermeasures, but also demands on the organisation.

Suitable tools are tree analyses, i.e. event trees supported by fault trees.

3.8 Detailed design of the observation system

The detailed design of an observation system includes both the instrumentation and the gathering and processing of the observations. The design of the observation system should consider not only the hardware, but also the organisation, as it is the overall accuracy of the system that governs the outcome.

The goal is an observation system which is cost-effective and where the risk is assessed and managed. Designing the observation system is usually an iterative process, where analysis of the initially chosen system may show that it does not meet all requirements. This may necessitate choosing new measuring points, for example.

The decision system approach may somewhat simplify the work of designing the observation system, since a decision tree can first be used to determine the requisite reliability of a hypothetical monitoring system. (The costs of outcomes are supposed to have already been calculated.) When the indicators to be observed and the observation points have been decided on, the details of the measurement system can be designed. The following steps should be taken in the detailed design of the observation system before it can be finalised and included in the building process:

- Assessment of the overall accuracy of the observation system.
- Formulation of a clear statement of the expected behaviour of the measured quantity as a part of the alarm threshold specification.
- Choice and implementation of instrumentation.
- Establishment of a system for Quality Assurance.
- Determination of suitable target values.

The option of making the design and construction of a project more robust should always be considered (smaller probability of failure), reducing dependence on a monitoring system.

Assessment of the overall accuracy of the observation system

The accuracy of the system is a function of its capacity to give correct alarms in time for countermeasures, while at the same time avoiding giving false alarms.

This accuracy is a function mainly of the choice of the correct prediction model, (including the choice of observation points) and the measurement accuracy. A thorough understanding of the problem at hand and the physical mechanisms that govern it is crucial for the choice of prediction model.

The difficult choice of prediction model necessitates designing the observation system so that it can effectively discriminate between different modes of behaviour of the rock mass. This can range from discriminating between elastic and plastic behaviour to discriminating between possible statistical models used in the design.

Even if an error has been made in judging the type of behaviour of the rock mass, the system should be able to function, although new alarm thresholds must of course be determined. This means that different models should be considered from the beginning so that one will not be left with a non-functioning system.

The system must also be able to discriminate between local (block) movements and global deformation. The influence of measurement precision is illustrated in Figure 9 (cf also Figure 5):

The greater the lack of precision, the greater the probability of getting an erroneously low value (alarm delayed), but also of course the probability of a false alarm.

The resolution of the measurement system influences the time it takes for a deviation from a presumed behaviour to be detected. A high resolution (together with a high precision) makes it possible to detect a behaviour such as in Figure 7 at an earlier stage.

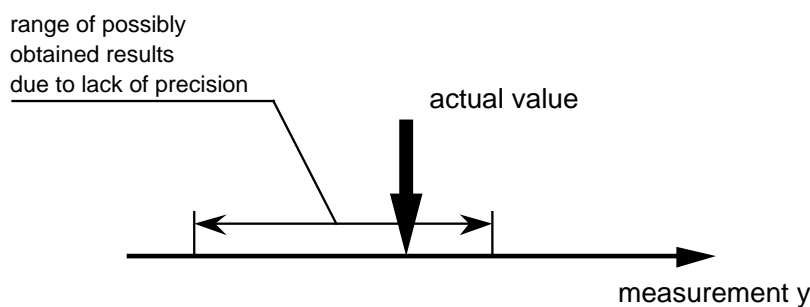

Figure 9. Influence of lack of precision.

Formulation of a clear statement of the expected behaviour of the measured quantity

To guard against errors made in choosing the prediction model, changed design conditions and errors of the measuring system, one should always include a statement about the expected behaviour of the measurements.

An example is shown in Figure 10a. An excavation was made using sheet piles to support the faces. A culvert for district heating had to cross the excavation and the pipe was supported by a “truss bridge”. This truss was designed to be simply supported with a roller bearing at one end. A monitoring system was installed, using an inclinometer to measure the deformation of one of the sheet pile walls. The alarm limit was formulated as a maximum lateral deformation of 50 mm, see Figure 10a.

As the excavation proceeded in stages, the deformation increased until the alarm limit was reached, see Figure 10b.

However, no one observed during the monitoring period that the recorded deformation patterns were not in compliance with the presumed static mode of action i.e. a simply supported beam. It proved to be the case that the roller bearing had been inadvertently welded stuck, so that the beam was now clamped and acted as a strut, a load case for which it was not designed. This could easily have led to an accident causing release of water in very large quantities into the work site.

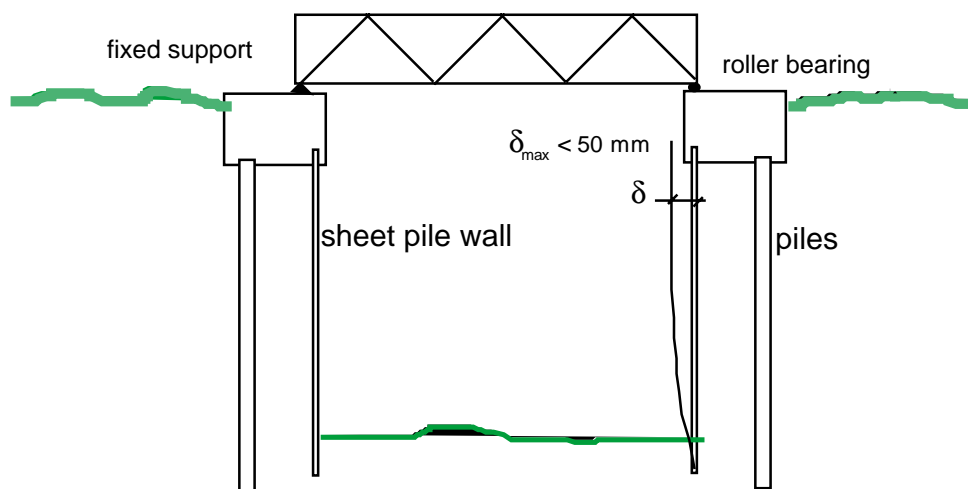

Figure 10a. Truss bridge for supporting pipes with inclinometer monitoring.

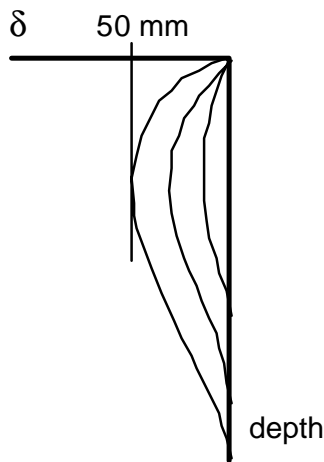

Figure 10b. Recorded deformation patterns.

Choice and implementation of instrumentation

The instrumentation must meet requirements on precision, low noise level and stability, as well as ease of operation (to avoid gross errors). Normally the assistance of a specialist company is sought for the instrumentation. A necessary part of the quality assurance of the observation monitoring system is to ensure that the requirements on the system are clearly defined and communicated to the specialists and that they in turn submit a statement of the accuracy of their proposed instrumentation. It should also be a requirement that the personnel who will operate the system be given training in how to handle it.

A running-in period for the system will enable necessary reference values to be obtained. It can also be used for a practical trial run of the entire system up to the actual execution of the countermeasures.

All necessary manuals and operating instructions are a part of the quality system and shall be included in the quality control manual.

It is important that the whole monitoring system be designed with human error aspects in mind. Since a computer is not biased like a human might be, interpretation of the data should be done using statistical and other methods and not just eyeballing.

An alarm should be given in such a form that it is immediately observed and that it requires acknowledgement by the user.

A monitoring system with defined alarm thresholds must also be designed so that alarms definitely mean that something is wrong and must be remedied. If the alarm limits are set too low, so that an alarm is given when no real danger is present, people will distrust it ("Cry wolf" effect).

Establishment of a system for Quality Assurance

Observation systems with alarm thresholds are frequently used for underground projects with a high degree of complexity. Quality assurance of the observation system can therefore be regarded as a part of the required quality system for the total project. A dualistic quality system is proposed /Stille et al, 1998/. The same set of tools can therefore be used, such as project model, risk and system analysis, ISO 9001, technical audit and team qualification.

Determination of suitable target values

Although it is not a necessary part of the observation system as used for protection of sensitive functions, target values will often be used for optimising the construction work, e.g. when choosing blasting rounds. A target value can be defined as the goal of such construction work design. This target value is chosen in conformity with the alarm threshold using a decision analysis approach. The consequence to be avoided is transgression of the alarm threshold with associated costs.

In this decision analysis, variation of the construction method/rock mass combination will be decisive, and the value of added information (e.g. through soundings) should be investigated, as should the inherent variation in different construction methods.

3.9 Observation, follow-up and updating

As construction proceeds, more and more is learnt about the rock's behaviour. This new information should of course be used. The system should if at all possible allow for the updating of parameters (and models). This can be done using Bayesian statistics in the decision analysis, including analysis of the value of added information. As for the choice of model, Bayesian model discrimination could be useful, and if AI methods are used models could be updated by incorporating the observations in the training set and repeating the training.

The Bayesian approach and Bayesian statistics is a broad subject, which will not be treated here. It is important to note that good engineering practice employs an approach which is Bayesian in its nature with an à priori notion of what observations should be expected. This notion is then revised (updated) on the basis of observations made, taking into account their understood relevance. It should also be noted that recent advances in Bayesian statistics and available computing power in modern personal computers make a stringent updating procedure into a viable and practical concept.

4 Conclusions and further work

The decision-based methodology described above has wide applications in the building process. It can be applied whenever the exact outcome of the work is not known and where countermeasures might be needed. One such application is in the pre-investigations for the siting of spent nuclear fuel facilities aimed at determining the criteria for abandoning work on a given site.

It can be seen that the principles of for designing an observation system and determining the alarm threshold are well understood. Several possible theoretical tools are also known, albeit from other disciplines than civil engineering. However, the choice of tools for a real problem should be investigated so that the advantages and drawbacks are illustrated.

Reliable methods for designing observation systems in practice are, however, not known and are therefore not in use. A continuation of this study should therefore be aimed at comparing different theoretical tools and examining their practical application, including Quality Assurance and updating.

It is therefore suggested that an observation system with alarm thresholds etc should be designed using the principles described in this report and should include testing and comparison of different models for predicting behaviour. This work could be undertaken for a real or for a hypothetical project. A real project is, of course, more difficult but has all the real-world problems that must be solved.

A very brief, and not theoretically fully developed, account (translated from Swedish) of the application of an observation system during the expansion of the interim spent fuel storage facility CLAB is enclosed as Appendix 1. Some comments on proposed changes in the system based on the principles set forth in this report are given in Appendix 2.

References

- Auvinet G, Bouayed A, Orlandi S, López A, 1996.** Stochastic finite element method in geomechanics. I Shackelford, Nelson & Roth (red):Uncertainty in the geologic environment: from theory to practice. ASCE.
- Baecher G, 1981.** Risk screening for civil facilities. MIT CR R-81-7.
- Baecher G B, Ingra T S, 1981.** "Stochastic FEM in settlement predictions," Journal of the Geotechnical Engineering Division, ASCE, 107(GT4).
- Bredenberg H, Olsson L, Stille H, 1981.** Övervakning av grundläggningsarbeten i tätort. STU information nr 253-1981 (in Swedish).
- Frisén M, 1992.** Evaluation of methods for statistical surveillance. Dept. of statistics, University of Gothenburg. Reprints 1992:2.
- Hachich W, Vanmarcke E H, 1983.** Probabilistic updating of pore pressure fields. Journal of the Geotechnical Engineering Division, ASCE, 109, No 3.
- Haimes Y, 1998.** Risk modelling, assessment, and management. John Wiley & Sons, Inc.
- Hand D, 1997.** Construction and assessment of classification rules. John Wiley & Sons, Inc.
- Krauland N, 1982.** Bergmekaniska fältmätningar och observationer BeFo Nr 39:2/81.
- Olsson L, Stille H, 1980.** Lönar sig en kompletterande grundundersökning? Beslutsteori tillämpad på ett spontningsobjekt. BFR rapport R174:1980 (in Swedish).
- Olsson L, 1986.** Användning av β -metoden i geotekniken – illustrerad med spontberäkning. Thesis. Institutionen för jord- och bergmekanik, KTH (in Swedish).
- Olsson L, 2000.** Att bestämma subjektiva sannolikheter. SGI Varia 488.
- Paté-Cornell M E, Benito-Claudio C Pe, 1987.** Warning systems: response models and optimization. In: Uncertainty in risk Assessment, Risk Management and Decision Making. Covello V T et al (eds).
- Peck R B, 1969.** Advantages and limitations of the observational method in applied soil mechanics. *Géotechnique* 19, No 2.
- Rosenblueth E, 1975.** Point estimates for probability moments. Proc. Nat. Acad. Sci. USA. Vol 72, No 10.
- Stille H, Olsson L, Delin P, 1981.** Bergmekaniska mätsystem BeFo Nr 48:1/81.

Stille H, Sturk R, Olsson L, 1998. Quality systems and risk analysis-new philosophies in underground construction industry. Int Conf in Underground Construction in Modern Infrastructure, Balkema, Rotterdam.

Sällfors G, 1990. Punktskattningsmetoden. En statistisk metod användbar på geotekniska problem. Geohydrologiska forskningsgruppen, CTH. Medd. nr 89.

Vanmarcke E, 1980. Probabilistic stability analysis of earth slopes. Engineering geology Vol.16 No 1/2.

Alarm thresholds – a tool for designing underground facilities

Introduction

Observation systems with predefined alarm thresholds have gained increasing use within soil and rock mechanics. Analysis of projects where observations with defined alarm thresholds have been used indicates that problems can arise if the observation system and the alarm thresholds are improperly chosen or are not related to the actual problem. Excessively conservative alarm thresholds that are constantly being exceeded and therefore have to be changed soon lose in credibility (the “cry wolf” effect). Alarm thresholds that are too generous are, on the other hand, dangerous.

The purpose of this paper is to offer some viewpoints in this matter and discuss the principles underlying alarm thresholds and methodology for choosing them.

Observations during the construction period are a common way of following up the excavation of rock structures. This is often called the observational method or “active design”, but the concept also includes linking predetermined actions to certain measurement results /Bredenberg et al, 1981/. Alarm thresholds can therefore be regarded as a special case of active design, where the predetermined action is to interrupt the work and issue an alarm.

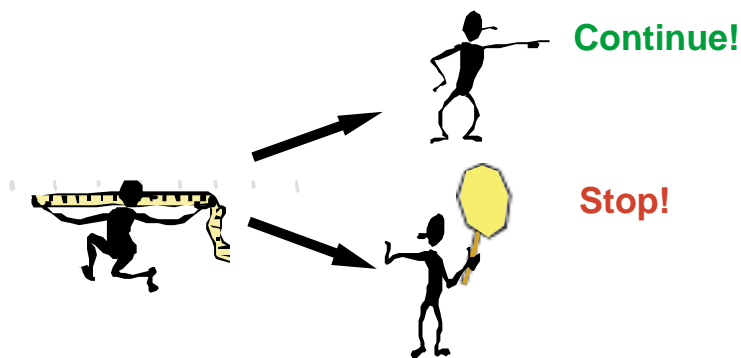

Figure A-1. Principles of an observation system with alarm thresholds.

What is an alarm threshold?

“Alarm threshold” has the following meaning in this article:

The alarm threshold is a predetermined value of one or a combination of several observation results which, if exceeded, triggers predetermined actions to prevent damage.

Examples of alarm thresholds:

- a) “The movement measured by extensometer No 1 exceeds 2.0 mm.”
- b) “The movement measured in the convergence measurement section C exceeds 6 mm and the rate is increasing (i.e. the time derivative is larger than 0) **or** the movement exceeds 10 mm.”
- c) “New cracks in the shotcrete on the wall.”

The alarm threshold does thus not have to be a single measured value, but it must be associated with something that can be observed and it must be unambiguously defined. It constitutes a boundary (dichotomy) between what we consider safe and what we consider dangerous, see Figure A-2, and we use it as a criterion for initiating corrective actions.

This threshold distinguishes between two classes of rock structures: safe and unsatisfactory. The choice of alarm threshold can thus be seen as a classification problem, and methods from this field can be used, see for example /Hand, 1997/.

“The movement measured by extensometer No 1 exceeds 2.0 mm.”

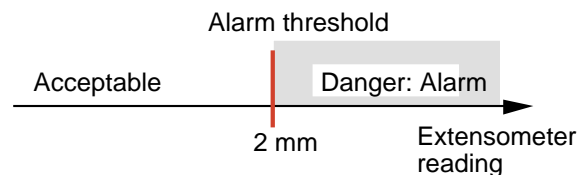

“The movement measured in the convergence measurement section C exceeds 6 mm and the rate is increasing (i.e. the time derivative is larger than 0) **or** the movement exceeds 10 mm.”

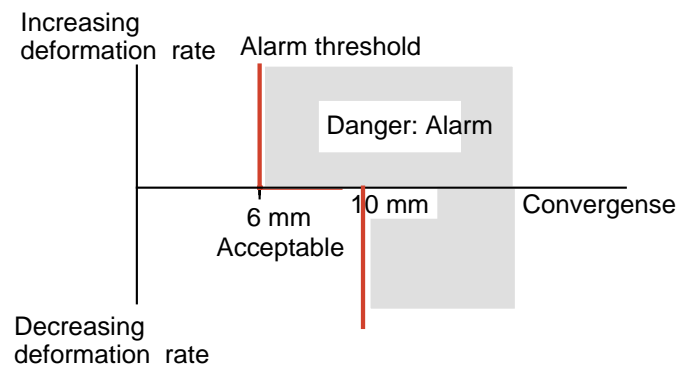

Figure A-2. Examples of alarm thresholds.

The principles underlying alarm thresholds and a theoretical methodology for how they should be chosen are discussed in this article.

Since SKB has applied alarm thresholds in the construction of CLAB stage 2 and has some experience from this project, CLAB stage 2 will be used as an example to illustrate the description.

The purpose of the measurement system with alarm thresholds that was implemented was to safeguard operations at the existing CLAB facility.

CLAB is an interim storage facility for spent nuclear fuel, where the fuel is stored pending final disposal. Since the fuel emits decay heat, it is stored in water-filled pools which are cooled via heat exchangers. Handling equipment suspended from an overhead crane is used in CLAB to move the fuel assemblies to and within the pool. The pool water is kept completely pure (ion-exchanged) to ensure that corrosion does not occur.

Safety arrangements are rigorous, and in order to ensure that no radioactivity is released the rock chamber is lined with a steel sheet ceiling and concrete walls. The ventilation is controlled so that negative pressure is maintained in the pool chamber, and all exhaust air passes through filters and detectors.

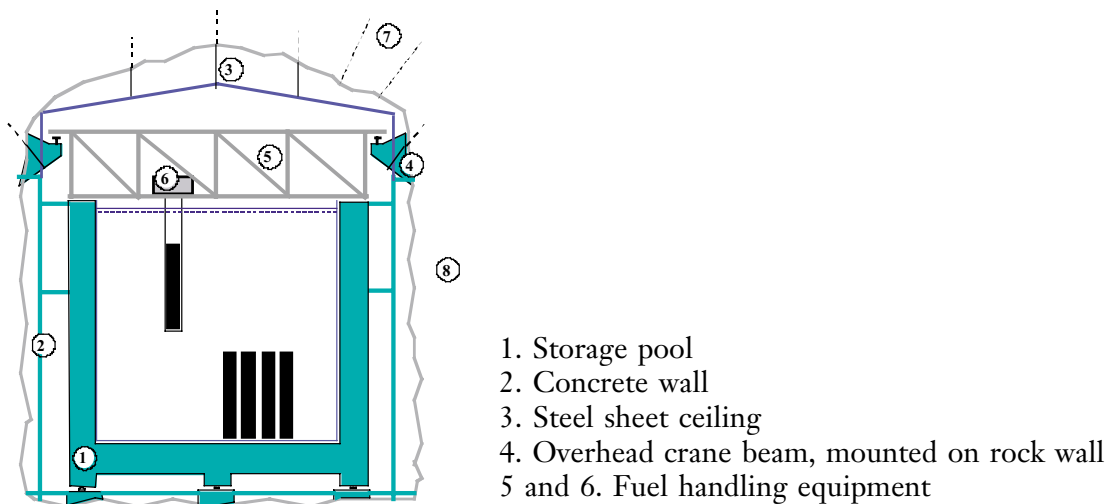

Figure A-3. Schematic section through CLAB.

Problem description

Schematically, the choice of observation system with alarm threshold can be described as a decision tree, see Figure A-4.

Some essential properties of alarm systems are illustrated in the figure, for example that both false alarm and failed alarm can occur (with a given probability) and that both entail costs.

A choice of alarm system based purely on economic grounds is governed by the cost of the damage and the probability that it will occur /see e.g. Olsson and Stille, 1980/. This means that damage with small consequences does not justify an expensive alarm system, even if it has a significant probability of occurring. But it also means that very costly damage with sufficiently low probability (i.e. low risk) does not justify an alarm system either.

This problem, with events of low probability and high consequences, is common in rock construction and must be dealt with as a special case. The usual decision principle of using expected cost is not applicable, see e.g. /Haimes, 1998/.

In the case of CLAB, with the safety principle *“It is simply not allowed to happen!”*, expected cost may not be used. Since no alarm system is perfect, the question nevertheless remains as to how great a probability can be accepted for failure of a correct alarm (and to some extent for false alarm as well, since such alarms may lead to the “cry wolf” effect, i.e. non-response). This is the sensitive question of risk evaluation and allowable risk and is not dealt with here, since the methodology for choice of observation system and alarm thresholds can be described anyway.

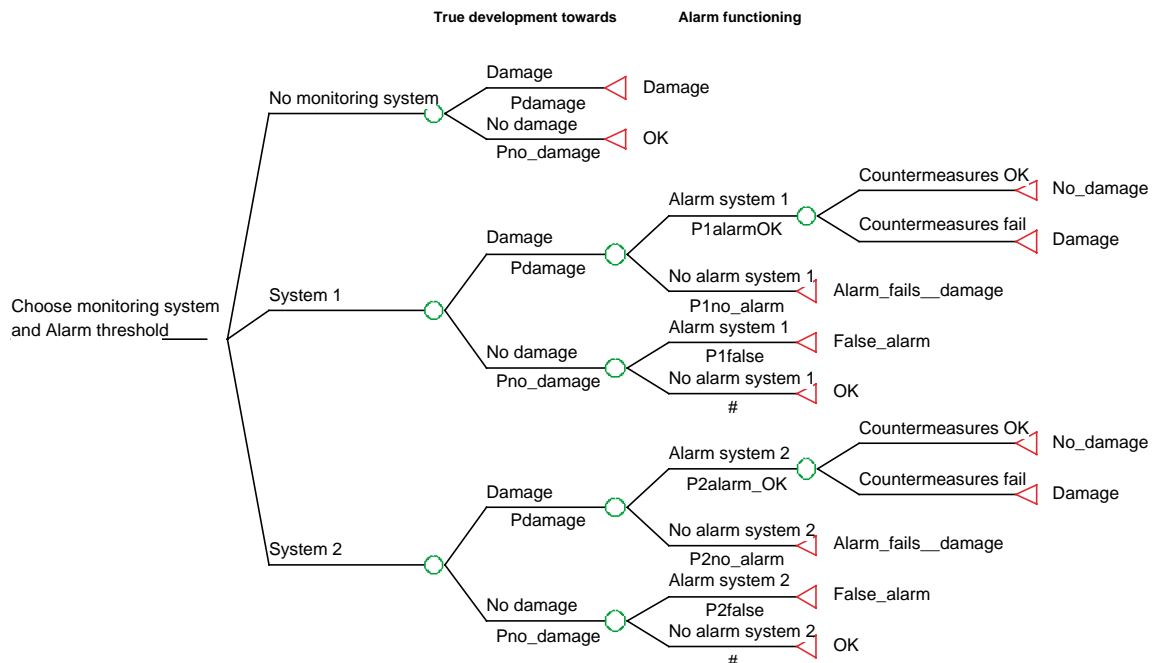

Figure A-4. Decision tree for choice of observation system and alarm thresholds.

Basic methodology for determining alarm thresholds

In order to determine the alarm thresholds, it is necessary to proceed systematically and take the basic requirements into account. A proposed procedure is described below:

- 1) Identify the sensitive functions that are to be protected.
- 2) Define damage limits for the functions.
- 3) Identify damage mechanisms that affect the functions.
- 4) Find observable/measurable indicators.
- 5) Select what is to be observed and measurement points and determine the alarm threshold.
- 6) Observe, follow up and update. Make changes if necessary.

Identify the sensitive functions that are to be protected

The purpose of alarm thresholds is to stop the work before it can cause damage. A risk analysis, for example with a fault tree, is performed to find possible threats to the particular function. A simplified example related to CLAB is shown in Figure A-5.

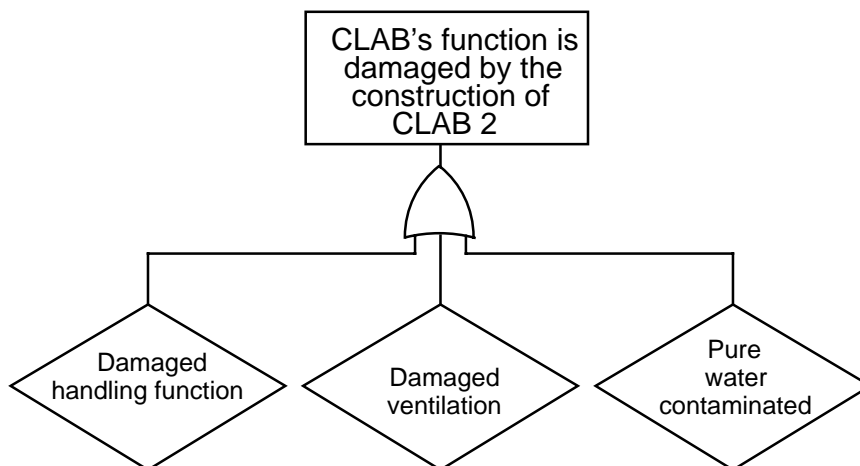

Figure A-5. Fault tree showing threats to the function of CLAB.

Define damage limits for the functions

It is important in the analysis to define how tolerant the different functions are to disturbances and exactly what disturbs the function. This must be based on engineering know-how, where risk analyses can help, see Figure A-6. It is important to focus on the function itself and not on future impacts.

By means of further analysis, discussion with the manufacturer, etc, the size of the displacement of the track where the track no longer works is arrived at, e.g. 4 mm lateral displacement or 2 mm vertical displacement.

Identify damage mechanisms that affect the functions

The next step is to identify the (rock-mechanical) damage mechanisms that can affect the functions to such a degree that the damage limit is approached.

Evaluation of the rock-mechanical damage mechanisms must of course be based on a holistic view and knowledge. In the case discussed above, undesirable deformations in the brackets can be caused by the following damage mechanisms:

- rock movements due to rock extraction for CLAB 2,
- strut failure due to dynamic supplementary loads generated by blasting,
- bracket movements due to shock waves that throw out the bracket, generated by blasting.

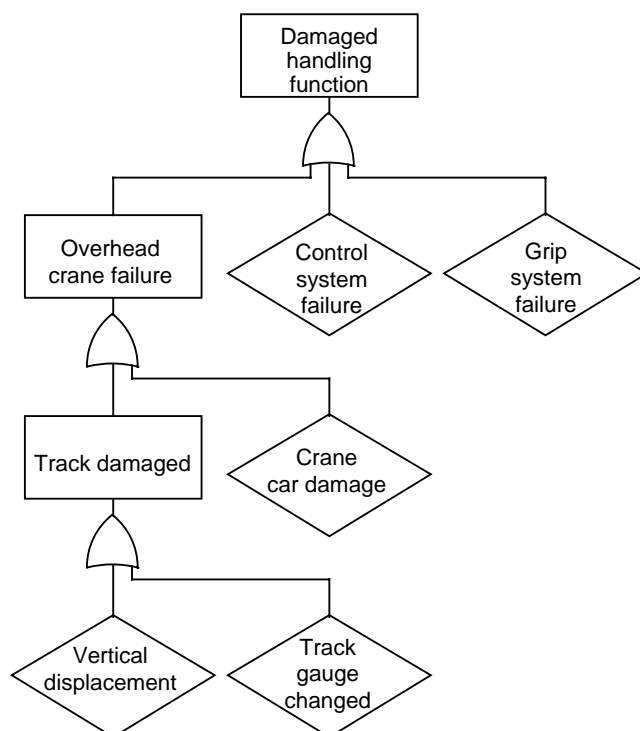

Figure A-6. Fault tree for the waste handling function at CLAB.

Find observable/measurable indicators related to the damage mechanisms

Since the purpose of the alarm thresholds is to prevent damage, the alarm must be given in time, before the damage has occurred. We therefore want to make a prediction of rock behaviour. To be effective, the model must enable us to determine from measurements and other observations both whether the rock behaves as predicted (i.e. that our model has good predictive capability) and that we are approaching a damage limit.

We can call these measurement results indicators, since they indicate if we are approaching danger. Such an indicator can, as mentioned above, consist of a single value or be composed of a combination of values. Naturally, it must also be observable in all its components. This means that it may not always be possible to choose the indicator that could directly indicate the rock-mechanical phenomenon, quite simply because it is not observable in a suitable point or at all.

In the case with the overhead crane discussed above, there are a number of possible damage mechanisms, all of which must be taken into account and monitored. Suitable indicators can be measurement of vertical movements of the crane, measurement of the horizontal movements of the brackets by means of convergence measurement over CLAB 1, measurement of the strut force by means of pressure cells, or measurement of the vibration in the brackets.

Movement measurement is often performed intermittently, which means that both the absolute value and the trend must be analyzed in order to assess the risk of damage in connection with new future loading, i.e. rock extraction rounds in CLAB 2, and thereby determine which alarm threshold should be set. This is because deformation is a cumulative process.

The measurements with pressure cells and vibrometers are often performed as continuous monitoring. The loading from the blasts can be regarded as individual load cases even if there are many of them. The risk of overloading is studied by studying the results from each round as well as the statistical outcome in order to determine the risk of overloading in connection with future rounds. This affects the choice of alarm thresholds.

Since all predictions having to do with rock are associated with uncertainties, it cannot be said that there is an exact value corresponding to dangerous behaviour; rather, a value span must be given expressed in terms of probabilities, see Figure A-7. The figure shows that the rock exhibits two behaviours, one of which represents a safe advance per round, while the other is dangerous. A measurement result in the overlapping area in the middle can therefore not distinguish with certainty between safe and dangerous behaviour of the rock. This means there is some uncertainty, or in other words a probability for incorrect classification at given alarm thresholds.

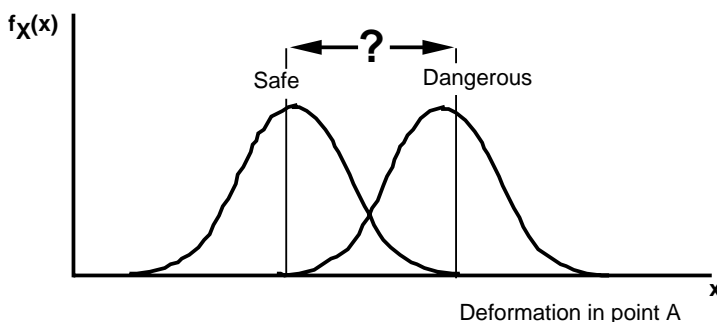

Figure A-7. Uncertainty in predictions.

Select what is to be observed and measurement points and determine the alarm thresholds

When suitable, observable indicators have been found, it is necessary to select which ones should be used and, equally importantly, what the alarm threshold should be set at.

In the case of damage mechanisms that are linked to vibration from blasting, a clear flow of information takes place to the builder so he can control his work, i.e. reduce or increase the size of the combined charge. In this case the alarm threshold has a clear-cut relationship with the risk of damage.

In the case of damage mechanisms that are linked to cumulative deformations associated with the extraction of CLAB 2, the situation is more complicated. Elastic deformations can in principle not be avoided, so if they become too great it must be possible to adjust the overhead crane. Deformations due to plastic deformations in the rock can be influenced to some extent by rock reinforcement. Monitoring will then also be used as a measure of whether the reinforcement used is right and reasonable and whether the rock structure has the intended safety level. In this case the interpretation and the alarm thresholds must be able to distinguish between what can be influenced and what cannot be influenced. This means that both the trend and the absolute value must be taken into account in choosing the alarm threshold.

The alarm threshold must be chosen with a view towards the required distinguishing capacity and the probability of false alarm and failed alarm. It is a decision limit, and if we don't manage to find a suitable indicator (with sufficient distinguishing capacity), we have to find a better or complementary indicator. See Figure A-8, which shows how a sharper indicator leads to a higher permissible "safe" alarm threshold.

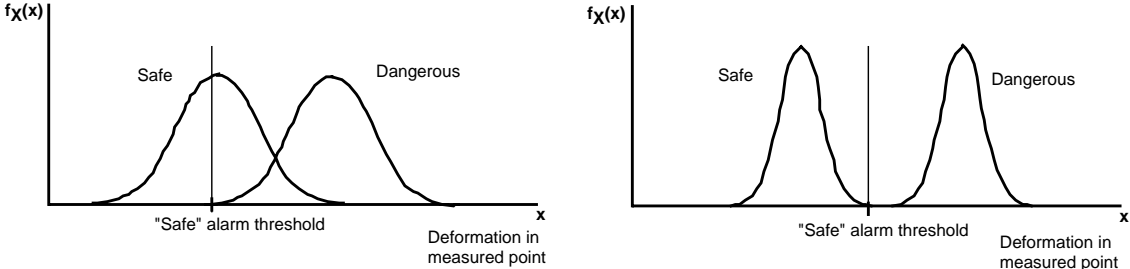

Figure A-8. Dependence of the alarm threshold on the distinguishing capacity of the indicators.

One way to find indicators and the alarm threshold is by direct calculation. A numerical calculation method must normally be used for this, such as FEM, when the indicator is a deformation. One problem then is that an expectation model is then normally obtained, in other words the equivalent of the mean value in statistical terms. Using this as an alarm threshold leads to transgression of the alarm threshold in 50% of the cases. What we need is not just a mean value of the movements, but an idea of uncertainty as well. The way to determine the alarm threshold is by means of a decision analysis, where an essential element is the probabilities of failed alarm and of false alarm, see Figure A-4. There are different options for calculating these uncertainties, for example Monte Carlo simulation or the point estimation method /Rosenblueth, 1975; Sällfors, 1990/. Another probably more effective way may be the use of stochastic FEM, where both the mean value and the standard deviation are obtained for all elements, see /Auvinet et al, 1996/, who also note that it is possible to use stochastic FEM in addition to existing FEM programs without the latter having to be modified.

Similar calculation problems exist for other types of indicators. But it is often difficult to base the design of the alarm system and the alarm threshold on calculations; instead, experiential data or expert knowledge must be made use of. As far as “pure” experiential data are concerned, in many cases enough data are not available to enable the alarm threshold to be determined on a purely statistical basis. The principle then is that a collection of observation data is available from both rock structures that have worked as desired and ones with problems, see Figure A-9.

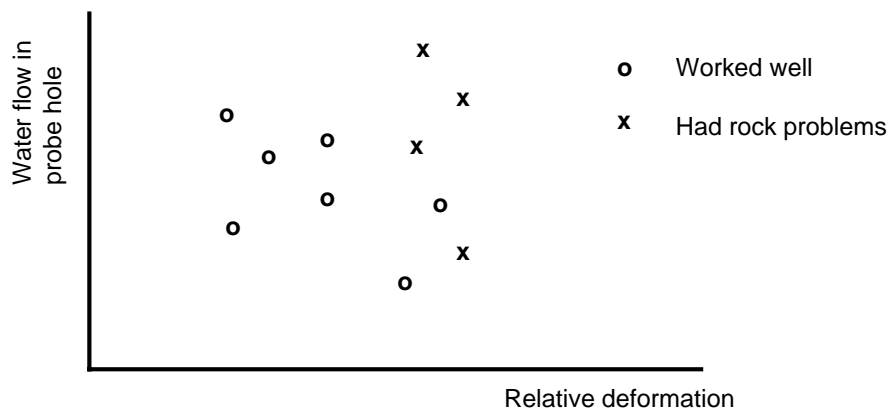

Figure A-9. Observed data from different sites.

From these data it is then possible by means of different statistical and other methods to find effective indicators and combinations of indicators, see for example /Hand, 1997/. This can also be done if more than two different indicators have been observed for each case. In many cases, however, sufficient data quantities are not available for these methods to be practically applicable. With few data the determination is uncertain and care must be taken in the choice of alarm threshold.

The alternative in such cases is to make use of whatever expert knowledge is available and express it in a useful fashion, i.e. so that a measure of the uncertainty is obtained. This is done with subjective methods and taking into account the sources of error that may exist, see e.g. /Olsson, 2000/. Probably the most suitable way is to describe the probability of observing a given phenomenon if conditions are safe and if there is danger. The assessment can take the form of a matrix, see Figure A-10.

In cases where a continuous variable is observed, for example an extensometer, the same methodology can be used, but repeated for different measurement values.

The probability of damage, and from it the alarm threshold, can then be calculated by using Bayes' theorem in some suitable form. This is a known problem within medicine (diagnoses based on tests) and methodology from there can be used, for example employing the odds ratio, which has also been proposed for dam safety applications by /Baecher, 1981/.

A method that can be used to choose between indicators is the AHP (Analytic Hierarchy Process) method, where the different indicators are subjected to pair-wise comparison and a ranking list is obtained after calculations.

Indicator shows	Actual situation	
	Danger	No danger
Danger	0,4	0,7
No danger	0,6	0,3

Figure A-10. Matrix showing the reliability of an indicator.

Observe, follow up and update. Make changes if necessary

Once the alarm system is in operation and begins to yield observation results, they can be utilized to check the selected alarm threshold, etc.

Normally, the assumptions made are rather uncertain, so the alarm system should not be regarded as something static and unchanging. It must be updated when site-specific data are obtained. Bayes' theorem is used for this as well. It may even be necessary to make radical changes in the system if it doesn't work well. Classification based on the uncertainty of the indicator can make it easier to make changes during ongoing work if necessary.

How can the alarm system be used for design?

Alarm thresholds should not be used without an understanding of the underlying damage mechanisms and the design situation. They may then do greater harm than good, since they can lull the user into a false sense of security or lead to unnecessary disruptions in the work.

Properly used, they can instead allow cost savings in design and construction, since the actual risk level diminishes due to the fact that the probability of failure decreases and that the consequences can be mitigated thanks to the fact that an early warning is obtained.

Some differences between the principles recommended in the report and the observation system used for CLAB stage 2

Recommendation	CLAB stage 2
Identify sensitive functions.	Yes (risk analysis)
Identify damage mechanisms, critical limits and direct countermeasures.	Yes, but not systematically
Find indicators linked to the damage mechanism, establish critical limits.	Yes, but not fully
Identify potentially dangerous work steps and countermeasures.	Yes, but not systematically
Predict the behaviour of the rock.	A detailed analysis was carried out but only aimed at determining the expected behaviour and not at establishing the critical limits for stability to the full extent.
Establish alarm thresholds taking into account countermeasures and response time (lead time).	Not based on decision analysis. Alarm threshold for deformations not correctly determined. Lead time was based on experiences and not on a detailed analysis.
Detailed design of the observation system.	Yes
Implement, observe, follow up and update. Make changes if necessary.	The alarm thresholds were fixed by the project.